

# General Specifications

Toggles

Rockers  
B

Pushbuttons

Illuminated PB

Programmable

Keylocks

Rotaries

Slides

Tactiles

Tilt

Touch

Indicators

Accessories

Supplement

## Electrical Capacity (Resistive Load)

**Logic Level:** 0.4VA maximum @ 28V AC/DC maximum  
(Applicable Range 0.1mA ~ 0.1A @ 20mV ~ 28V)  
Note: Find additional explanation of operating range in Supplement section.

## Other Ratings

**Contact Resistance:** 50 milliohms maximum  
**Insulation Resistance:** 500 megohms minimum @ 500V DC  
**Dielectric Strength:** 500V AC minimum for 1 minute minimum  
**Mechanical Life:** 100,000 operations minimum for On-None-On & On-Off-On  
 50,000 operations minimum for other circuits  
**Electrical Life:** 50,000 operations minimum  
**Nominal Operating Force:** 2.73N (momentary); 1.84N (maintained)  
**Contact Timing:** Nonshorting (break-before-make)  
**Angle of Throw:** 26°

## Materials & Finishes

**Actuator or Toggle:** Nickel plated brass  
**Case Housing:** Glass fiber reinforced polyamide  
**Support Bracket:** Tin plated phosphor bronze  
**Movable Contact:** Phosphor bronze with gold plating  
**Stationary Contacts:** Brass with gold plating  
**Terminals:** Brass with gold plating

## Environmental Data

**Operating Temperature Range:** -30°C through +85°C (-22°F through +185°F)  
**Humidity:** 90 ~ 95% humidity for 240 hours @ 40°C (104°F)  
**Vibration:** 10 ~ 55Hz with peak-to-peak amplitude of 1.5mm traversing the frequency range & returning in 1 minute; 3 right angled directions for 2 hours  
**Shock:** 50G (490m/s<sup>2</sup>) acceleration (tested in 6 right angled directions, with 5 shocks in each direction)

## Installation

**Cap Installation Force:** 39.23N (8.82 lbf) maximum downward force on actuator

## PCB Processing

**Soldering:** Wave Soldering Recommended: See Profile A in Supplement section.  
 Manual Soldering: See Profile B in Supplement section.  
**Cleaning:** Automated cleaning. See Cleaning specifications in Supplement section.

## Standards & Certifications

The A Series rockers have not been tested for UL recognition or CSA certification. These switches are designed for use in a low-voltage, low-current, logic-level circuit. When used as intended in a logic-level circuit, the results do not produce hazardous energy.

# Distinctive Characteristics

Subminiature size saves space on PC boards.

Specifically developed for logic-level applications.

Totally sealed body construction prevents contact contamination and allows time- and money-saving automated soldering and cleaning.

Award-winning STC contact mechanism with benefits unavailable in conventional mechanisms: smoother, positive detent actuation, increased contact stability and unparalleled logic-level reliability. (Additional STC details in Terms & Acronyms; see Supplement section.)

Molded-in, epoxy sealed or ultrasonically welded terminals lock out flux, solvents, and other contaminants.

.100" x .100" (2.54mm x 2.54mm) terminal spacing conforms to standard PC board grid spacing.

Matching indicators available.



Actual Size



Toggles
<b>B</b> Rockers
Pushbuttons
Illuminated PB
Programmable
Keylocks
Rotaries
Slides
Tactiles
Tilt
Touch
Indicators
Accessories
Supplement

### TYPICAL SWITCH ORDERING EXAMPLE



### DESCRIPTION FOR TYPICAL ORDERING EXAMPLE

#### A22K1H-DA

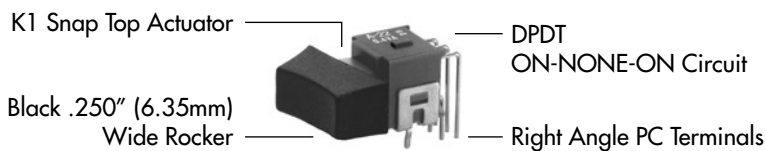

## POLES & CIRCUITS

Pole	Model	Rocker Position ( ) = Momentary			Connected Terminals			Throw & Schematics
		Up	Center	Down	Up	Center	Down	
								Note: Terminal numbers are not actually on the switch.
SP	A12 A13 A15 A1R A18 A19 A1S	ON ON ON (ON) (ON) ON (ON)	NONE NONE NONE NONE OFF OFF OFF	ON ON (ON) ON (ON) (ON) ON	2-3	OPEN	2-1	SPDT 
DP	A22 A23 A25 A2R A28 A29 A2S	ON ON ON (ON) (ON) ON (ON)	NONE OFF NONE NONE OFF OFF OFF	ON ON (ON) ON (ON) (ON) ON	2-3 5-6	OPEN	2-1 5-4	DPDT 

For 3 Throw (3-On)

Connected Terminals & Schematics					External Connection
Pole	Model	Up	Center	Down	
SP	A24 A26 A27	ON (ON) ON   2-3 5-6	ON ON ON   2-3 5-4	ON (ON) (ON)   2-1 5-4	The SP3T model utilizes a double pole base.  External connections must be made during field installation. 

## ACTUATORS



Snap Top

For Rocker AT469

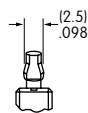
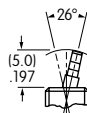

Snap Top

For Rockers AT062 and AT066



## PC TERMINALS

Use of a support bracket is recommended to increase PCB mounting strength and stability.

**P** Straight



**B** Straight with Bracket



**B1** Straight with Inline Bracket Single Pole only



**H** Right Angle with Bracket



**V** Vertical with Bracket



**V1** Vertical with Inline Bracket Single Pole only



## ROCKERS & COLORS

**C** AT469  
.260" (6.6mm) Wide Rocker

Antirotational  
Material: Polyamide  
Colors Available:  
A, B, C, E, F, G, H

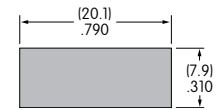
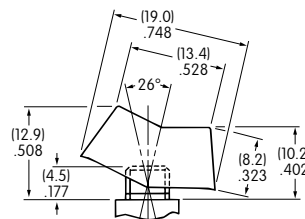

**D** AT062  
.250" (6.35mm) Wide Rocker

Antirotational  
Material: Polyamide  
Colors Available:  
A, B, C

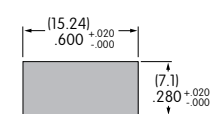

**E** AT066  
.300" (7.6mm) Wide Rocker

Antirotational  
Material: Polyamide  
Colors Available:  
A, B, C

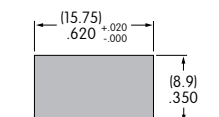
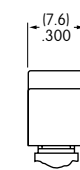
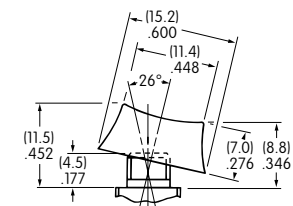
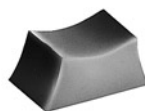

Color Codes:



Black



White



Red



Yellow



Green



Blue



Gray

TYPICAL SWITCH DIMENSIONS

Single Pole

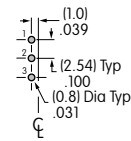
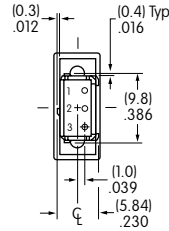
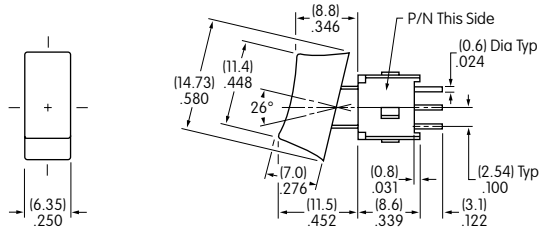

Straight PC



A12K1P-DA

Double Pole

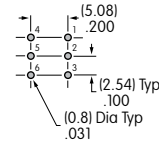
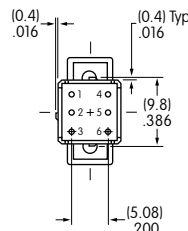
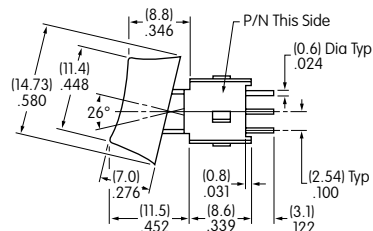
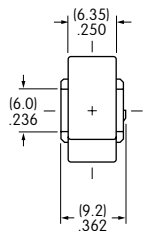

Straight PC



A22K1P-DA

Single Pole

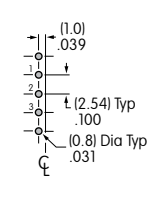
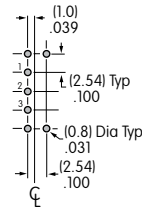
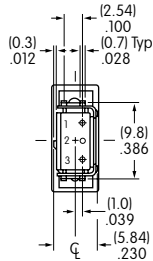
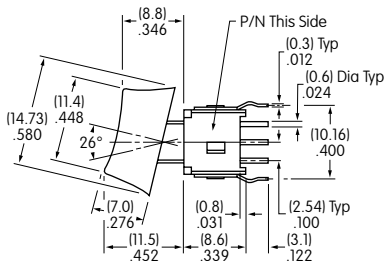
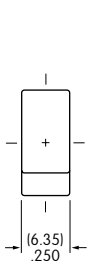

Straight PC • Bracket



A12K1B-DA

Double Pole

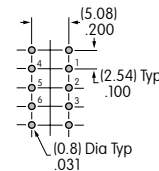
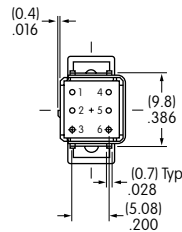
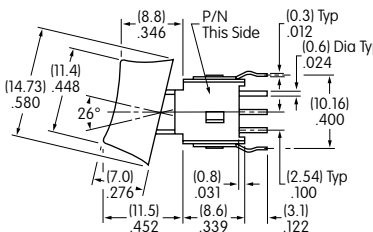
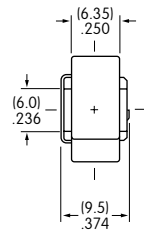

Straight PC • Bracket



A22K1B-DA

Single Pole

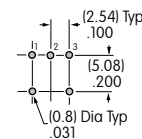
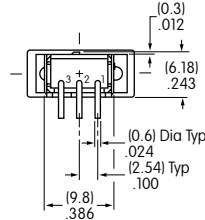
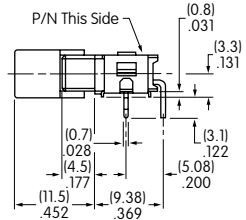
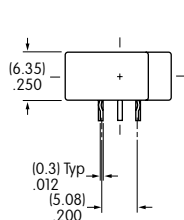

Right Angle PC



A12K1H-DA

## TYPICAL SWITCH DIMENSIONS

### Right Angle PC

### Double Pole

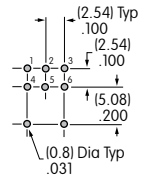

**A22K1H-DA**

### Vertical PC

### Single Pole

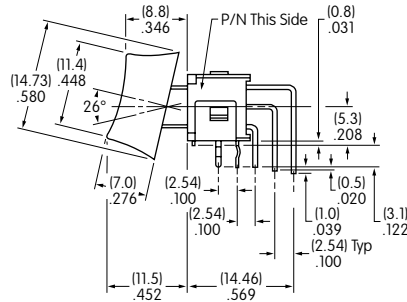

**A12K1V-DA**

V Terminals

V1 Terminals

### Vertical PC

### Double Pole

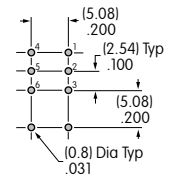

**A22K1V-DA**

## ROCKER MOUNTING PRECAUTION

Rocker switches with vertical and right angle terminals must be mounted so that extension of the PC board beyond the top of the switch housing does not interrupt rocker movement, in turn causing incomplete switching operation.

The MAXIMUM limit of the PC board extension is .051" (1.3mm), as illustrated below.

This precaution does not apply to the double pole switch with right angle terminals due to the extra width of the switch allowing the rocker to clear the PC board.

Side View of Rocker  
Right Angle Mounting PC  
Single Pole Only



Side View of Rocker  
Vertical Mounting PC  
Single Pole and  
Double Pole

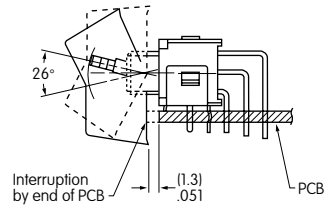



Компания «ЭлектроПласт» предлагает заключение долгосрочных отношений при поставках импортных электронных компонентов на взаимовыгодных условиях!

Наши преимущества:

- Оперативные поставки широкого спектра электронных компонентов отечественного и импортного производства напрямую от производителей и с крупнейших мировых складов;
- Поставка более 17-ти миллионов наименований электронных компонентов;
- Поставка сложных, дефицитных, либо снятых с производства позиций;
- Оперативные сроки поставки под заказ (от 5 рабочих дней);
- Экспресс доставка в любую точку России;
- Техническая поддержка проекта, помощь в подборе аналогов, поставка прототипов;
- Система менеджмента качества сертифицирована по Международному стандарту ISO 9001;
- Лицензия ФСБ на осуществление работ с использованием сведений, составляющих государственную тайну;
- Поставка специализированных компонентов (Xilinx, Altera, Analog Devices, Intersil, Interpoint, Microsemi, Aeroflex, Peregrine, Syfer, Eurofarad, Texas Instrument, Miteq, Cobham, E2V, MA-COM, Hittite, Mini-Circuits, General Dynamics и др.);

Помимо этого, одним из направлений компании «ЭлектроПласт» является направление «Источники питания». Мы предлагаем Вам помощь Конструкторского отдела:

- Подбор оптимального решения, техническое обоснование при выборе компонента;
- Подбор аналогов;
- Консультации по применению компонента;
- Поставка образцов и прототипов;
- Техническая поддержка проекта;
- Защита от снятия компонента с производства.



#### Как с нами связаться

**Телефон:** 8 (812) 309 58 32 (многоканальный)

**Факс:** 8 (812) 320-02-42

**Электронная почта:** [org@eplast1.ru](mailto:org@eplast1.ru)

**Адрес:** 198099, г. Санкт-Петербург, ул. Калинина, дом 2, корпус 4, литера А.