

## Product Summary

$V_{DS}$ (V)	100
$R_{DS(ON)}$ ( $\Omega$ )	10

## Description and Applications

This MOSFET utilizes a structure that combines low input capacitance with relatively low on-resistance and has an intrinsically higher pulse current handling capability in linear mode than a comparable trench technology structure. This MOSFET is suitable for general purpose applications.

- General purpose 100V FET
- Power management
- Disconnect switches
- Telecoms
- Complementary Type – ZVP3310F

## Features and Benefits

- High pulse current handling in linear mode
- Low input capacitance
- Fast switching speed
- **Lead Free By Design/RoHS Compliant (Note 1)**

## Mechanical Data

- Case: SOT-23
- Case Material: UL Flammability Classification Rating 94V-0
- Moisture sensitivity: Level 1 per J-STD-020
- Terminals: Matte Tin Finish annealed over Alloy 42 leadframe (Lead Free Plating). Solderable per MIL-STD-202, Method 208
- Terminal Connections: See Diagram
- Weight: 0.008 grams (approximate)

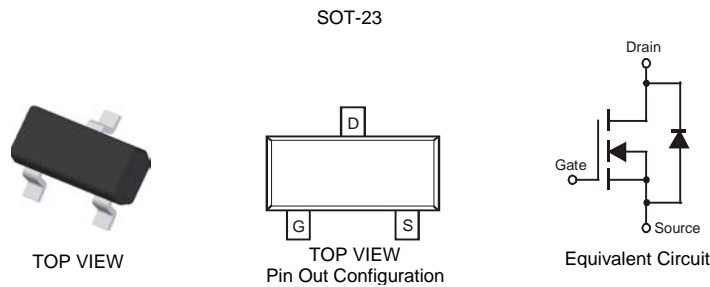

## Ordering Information (Note 2)

Product	Marking	Reel size (inches)	Tape width (mm)	Quantity per reel
ZVN3310FTA	MF	7	8	3000

- Notes:
1. No purposefully added lead.
  2. For packaging details, go to our website at <http://www.diodes.com/datasheets/ap02007.pdf>.

## Marking Information

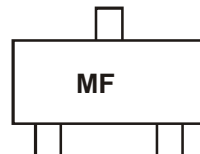

MF = Product Type Marking Code

### Maximum Ratings @T<sub>A</sub> = 25°C unless otherwise specified

Characteristic	Symbol	Value	Units
Drain-Source Voltage	V <sub>DSS</sub>	100	V
Gate-Source Voltage	V <sub>GSS</sub>	±20	V
Continuous Drain Current	I <sub>D</sub>	100	mA
Pulsed Drain Current	I <sub>DM</sub>	2	A

### Thermal Characteristics

Characteristic	Symbol	Value	Unit
Power Dissipation @T <sub>A</sub> = 25°C	P <sub>D</sub>	330	mW
Operating and Storage Temperature Range	T <sub>J</sub> , T <sub>STG</sub>	-55 to +150	°C

### Electrical Characteristics @T<sub>A</sub> = 25°C unless otherwise specified

Characteristic	Symbol	Min	Typ	Max	Unit	Test Condition
<b>OFF CHARACTERISTICS</b>						
Drain-Source Breakdown Voltage	BV <sub>DSS</sub>	100	—	—	V	I <sub>D</sub> = 1mA, V <sub>GS</sub> = 0V
Zero Gate Voltage Drain Current T <sub>J</sub> = 25°C T <sub>J</sub> = 125°C (Note 4)	I <sub>DSS</sub>	—	—	1 50	μA	V <sub>DS</sub> = 100V, V <sub>GS</sub> = 0V V <sub>DS</sub> = 80V, V <sub>GS</sub> = 0V
Gate-Source Leakage	I <sub>GSS</sub>	—	—	20	nA	V <sub>GS</sub> = ±20V, V <sub>DS</sub> = 0V
Gate Threshold Voltage	V <sub>GS(th)</sub>	0.8	—	2.4	V	V <sub>DS</sub> = V <sub>GS</sub> , I <sub>D</sub> = 1mA
<b>ON CHARACTERISTICS (Note 3)</b>						
On-State Drain Current	I <sub>D(ON)</sub>	500	—	—	mA	V <sub>DS</sub> = 25V, V <sub>GS</sub> = 10V
Static Drain-Source On-Resistance	R <sub>DS(ON)</sub>	—	—	10	Ω	V <sub>GS</sub> = 10V, I <sub>D</sub> = 500mA
<b>DYNAMIC CHARACTERISTICS (Note 4)</b>						
Forward Transconductance (Note 3)	g <sub>fs</sub>	100	—	—	mS	V <sub>DS</sub> = 25V, I <sub>D</sub> = 500mA
Input Capacitance	C <sub>iss</sub>	—	—	40	pF	V <sub>DS</sub> = 25V, V <sub>GS</sub> = 0V f = 1.0MHz
Output Capacitance	C <sub>oss</sub>	—	—	15		
Reverse Transfer Capacitance	C <sub>rss</sub>	—	—	5		
Turn-On Delay Time (Note 5)	t <sub>D(on)</sub>	—	3	5	ns	V <sub>DD</sub> ≈ 25V, I <sub>D</sub> = 500mA
Turn-On Rise Time (Note 5)	t <sub>r</sub>	—	5	7		
Turn-Off Delay Time (Note 5)	t <sub>D(off)</sub>	—	4	6		
Turn-Off Fall Time (Note 5)	t <sub>f</sub>	—	5	7		

- Notes:
3. Measured under pulsed conditions. Width = 300μs. Duty cycle ≤2%
  4. Sample test.
  5. Switching times measured with 50Ω source impedance and <5ns rise time on a pulse generator.

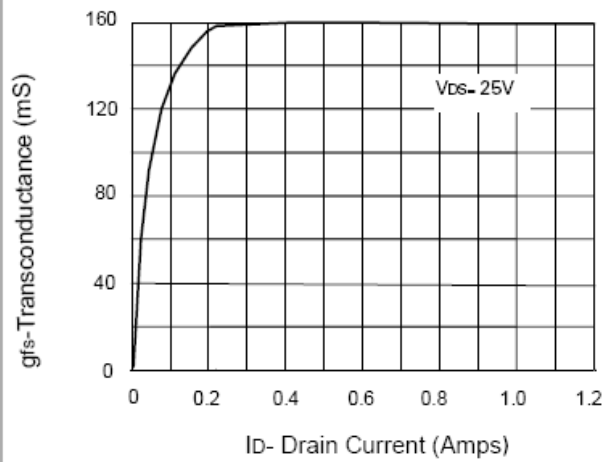

**Transconductance v drain current**

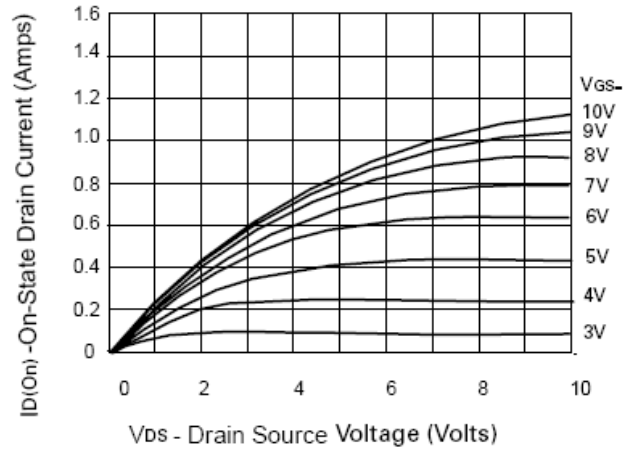

**Saturation Characteristics**

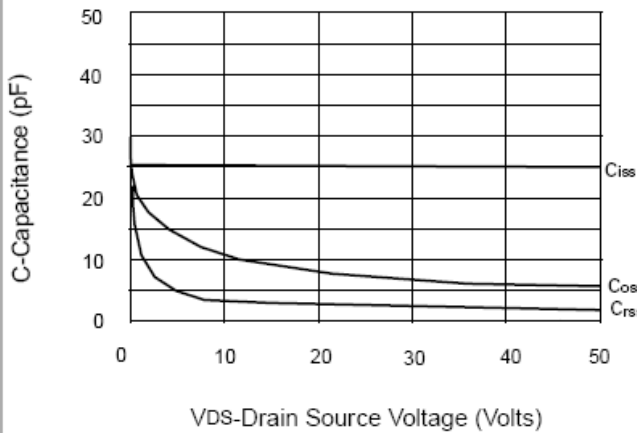

**Capacitance v drain-source voltage**

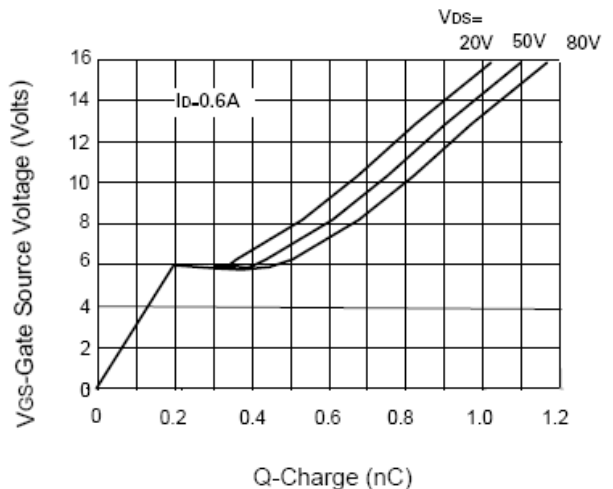

**Gate charge v gate-source voltage**

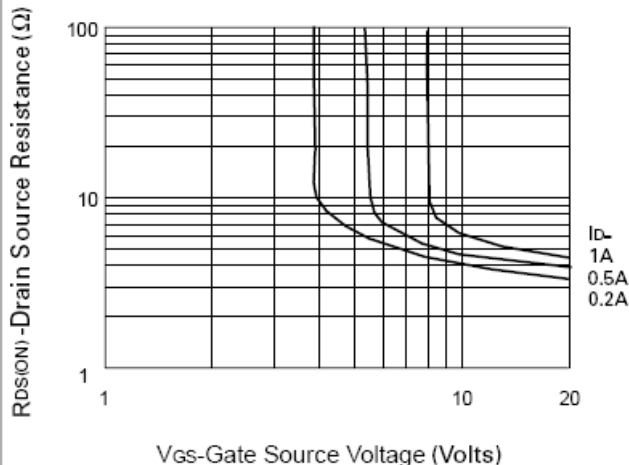

**On-resistance vs gate-source voltage**

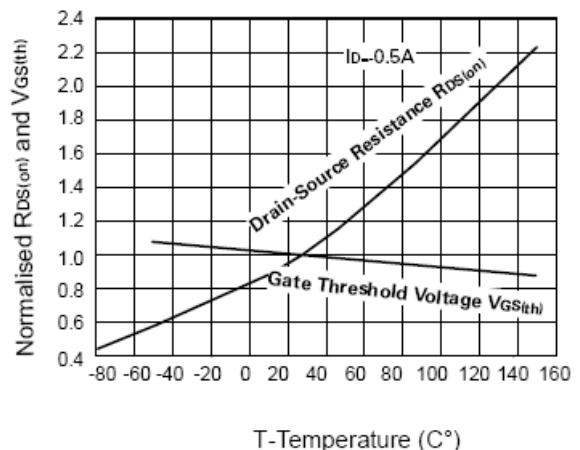

**Normalised RDS(on) and VGS(th) vs Temperature**

**Package Outline Dimensions**

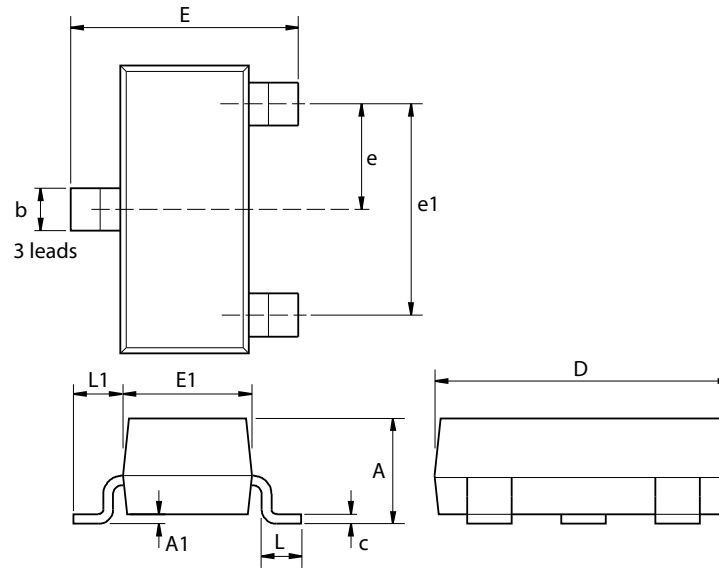

Dim.	Millimeters		Inches		Dim.	Millimeters		Inches	
	Min.	Max.	Min.	Max.		Min.	Max.	Min.	Max.
A	-	1.12	-	0.044	e1	1.90 NOM		0.075 NOM	
A1	0.01	0.10	0.0004	0.004	E	2.10	2.64	0.083	0.104
b	0.30	0.50	0.012	0.020	E1	1.20	1.40	0.047	0.055
c	0.085	0.20	0.003	0.008	L	0.25	0.60	0.0098	0.0236
D	2.80	3.04	0.110	0.120	L1	0.45	0.62	0.018	0.024
e	0.95 NOM		0.037 NOM		-	-	-	-	-

Note: Controlling dimensions are in millimeters. Approximate dimensions are provided in inches

**Suggested Pad Layout**

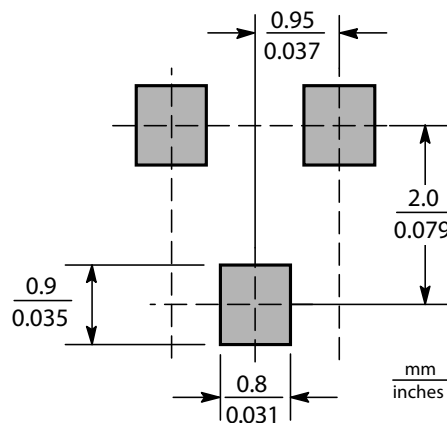

**IMPORTANT NOTICE**

DIODES INCORPORATED MAKES NO WARRANTY OF ANY KIND, EXPRESS OR IMPLIED, WITH REGARDING TO THIS DOCUMENT, INCLUDING, BUT NOT LIMITED TO, THE IMPLIED WARRANTIES OF MERCHANTABILITY AND FITNESS FOR A PARTICULAR PURPOSE (AND THEIR EQUIVALENTS UNDER THE LAWS OF ANY JURISDICTION).

Diodes Incorporated and its subsidiaries reserve the right to make modifications, enhancements, improvements, corrections or other changes without further notice to this document and any product described herein. Diodes Incorporated does not assume any liability arising out of the application or use of this document or any product described herein; neither does Diodes Incorporated convey any license under its patent or trademark rights, nor the rights of others. Any Customer or user of this document or products described herein in such applications shall assume all risks of such use and will agree to hold Diodes Incorporated and all the companies whose products are represented on Diodes Incorporated website, harmless against all damages.

Diodes Incorporated does not warrant or accept any liability whatsoever in respect of any products purchased through unauthorized sales channel. Should Customers purchase or use Diodes Incorporated products for any unintended or unauthorized application, Customers shall indemnify and hold Diodes Incorporated and its representatives harmless against all claims, damages, expenses, and attorney fees arising out of, directly or indirectly, any claim of personal injury or death associated with such unintended or unauthorized application.

Products described herein may be covered by one or more United States, international or foreign patents pending. Product names and markings noted herein may also be covered by one or more United States, international or foreign trademarks.

**LIFE SUPPORT**

Diodes Incorporated products are specifically not authorized for use as critical components in life support devices or systems without the express written approval of the Chief Executive Officer of Diodes Incorporated. As used herein:

A. Life support devices or systems are devices or systems which:

1. are intended to implant into the body, or
2. support or sustain life and whose failure to perform when properly used in accordance with instructions for use provided in the labeling can be reasonably expected to result in significant injury to the user.

B. A critical component is any component in a life support device or system whose failure to perform can be reasonably expected to cause the failure of the life support device or to affect its safety or effectiveness.

Customers represent that they have all necessary expertise in the safety and regulatory ramifications of their life support devices or systems, and acknowledge and agree that they are solely responsible for all legal, regulatory and safety-related requirements concerning their products and any use of Diodes Incorporated products in such safety-critical, life support devices or systems, notwithstanding any devices- or systems-related information or support that may be provided by Diodes Incorporated. Further, Customers must fully indemnify Diodes Incorporated and its representatives against any damages arising out of the use of Diodes Incorporated products in such safety-critical, life support devices or systems.

Copyright © 2009, Diodes Incorporated

[www.diodes.com](http://www.diodes.com)



Компания «ЭлектроПласт» предлагает заключение долгосрочных отношений при поставках импортных электронных компонентов на взаимовыгодных условиях!

Наши преимущества:

- Оперативные поставки широкого спектра электронных компонентов отечественного и импортного производства напрямую от производителей и с крупнейших мировых складов;
- Поставка более 17-ти миллионов наименований электронных компонентов;
- Поставка сложных, дефицитных, либо снятых с производства позиций;
- Оперативные сроки поставки под заказ (от 5 рабочих дней);
- Экспресс доставка в любую точку России;
- Техническая поддержка проекта, помощь в подборе аналогов, поставка прототипов;
- Система менеджмента качества сертифицирована по Международному стандарту ISO 9001;
- Лицензия ФСБ на осуществление работ с использованием сведений, составляющих государственную тайну;
- Поставка специализированных компонентов (Xilinx, Altera, Analog Devices, Intersil, Interpoint, Microsemi, Aeroflex, Peregrine, Syfer, Eurofarad, Texas Instrument, Miteq, Cobham, E2V, MA-COM, Hittite, Mini-Circuits, General Dynamics и др.);

Помимо этого, одним из направлений компании «ЭлектроПласт» является направление «Источники питания». Мы предлагаем Вам помощь Конструкторского отдела:

- Подбор оптимального решения, техническое обоснование при выборе компонента;
- Подбор аналогов;
- Консультации по применению компонента;
- Поставка образцов и прототипов;
- Техническая поддержка проекта;
- Защита от снятия компонента с производства.



#### Как с нами связаться

**Телефон:** 8 (812) 309 58 32 (многоканальный)

**Факс:** 8 (812) 320-02-42

**Электронная почта:** [org@eplast1.ru](mailto:org@eplast1.ru)

**Адрес:** 198099, г. Санкт-Петербург, ул. Калинина, дом 2, корпус 4, литера А.