

Analog Devices Welcomes Hittite Microwave Corporation

NO CONTENT ON THE ATTACHED DOCUMENT HAS CHANGED



THIS PAGE INTENTIONALLY LEFT BLANK



GaAs MMIC ANALOG VARIABLE GAIN AMPLIFIER, 6 - 17 GHz

Typical Applications

The HMC694LP4(E) is ideal for:

- Point-to-Point Radio
- Point-to-Multi-Point Radio
- EW & ECM
- X-Band Radar
- Test Equipment

Features

- Wide Gain Control Range: 23 dB
- Single Control Voltage
- Output IP3 @ Max Gain: +30 dBm
- Output P1dB: +22 dBm
- No External Matching
- 24 Lead 4x4 mm SMT Package: 16 mm²

Functional Diagram

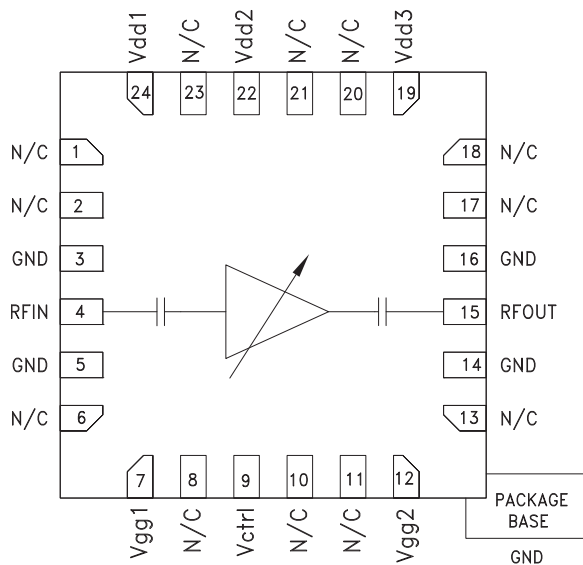

General Description

The HMC694LP4(E) is a GaAs MMIC PHEMT analog variable gain amplifier which operates between 6 and 17 GHz. Ideal for microwave radio applications, the amplifier provides up to 22 dB of gain, output P1 dB of up to +22 dBm, and up to +30 dBm of output IP3 at maximum gain, while requiring only 175 mA from a +5V supply. A gate bias pin (Vctrl) is provided to allow variable gain control up to 23 dB. Gain flatness is excellent making the HMC694LP4E ideal for EW, ECM and radar applications. The HMC694LP4E is housed in a RoHS compliant 4x4 mm QFN leadless package and is compatible with high volume surface mount manufacturing.

Electrical Specifications, $T_A = +25^\circ\text{C}$, $V_{dd1, 2, 3} = 5\text{V}$, $V_{ctrl} = -2\text{V}$, $I_{dd} = 170\text{mA}^*$

Parameter	Min.	Typ.	Max.	Min.	Typ.	Max.	Units
Frequency Range		6 - 10		10 - 17			GHz
Gain	19	22		14	18		dB
Gain Flatness		± 1			± 1.5		dB
Gain Variation Over Temperature		0.015			0.015		dB/ °C
Gain Control Range		23			20		dB
Noise Figure		6	7.5		6	6.5	dB
Input Return Loss		15			8		dB
Output Return Loss		10			8		dB
Output Power for 1 dB Compression (P1dB)	19	21		21	22		dBm
Saturated Output Power (Psat)		22			23		dBm
Output Third Order Intercept (IP3)		30			30		dBm
Total Supply Current (Idd)		175			175		mA

*Set Vctrl = -2V and then adjust Vgg1, 2 between -2V to 0V (typ. -0.8V) to achieve Idd = 170mA typical.



GaAs MMIC ANALOG VARIABLE GAIN AMPLIFIER, 6 - 17 GHz

Control Voltage Range vs. Gain

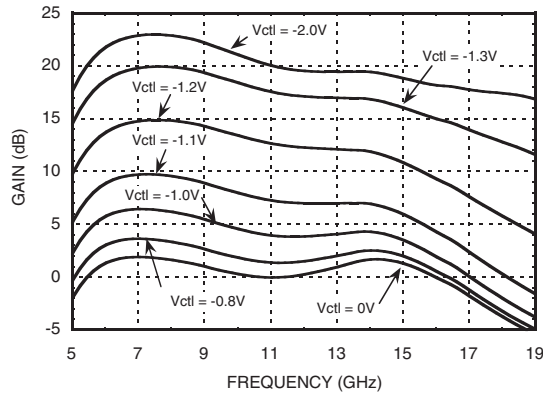

Gain vs. Control Voltage

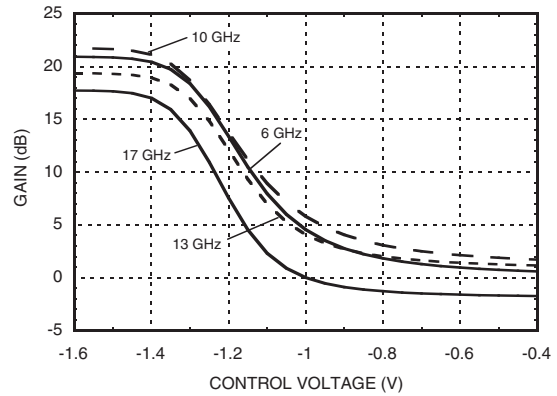

Broadband Gain & Return Loss

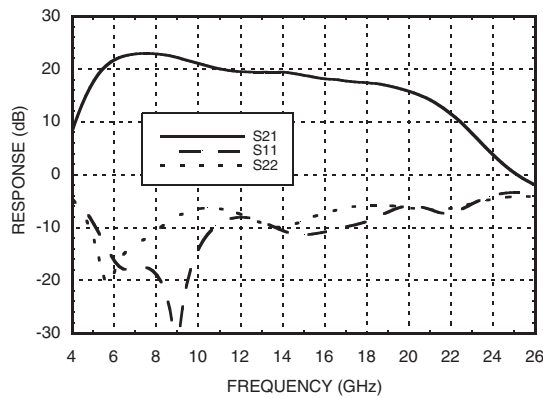

Gain vs. Temperature

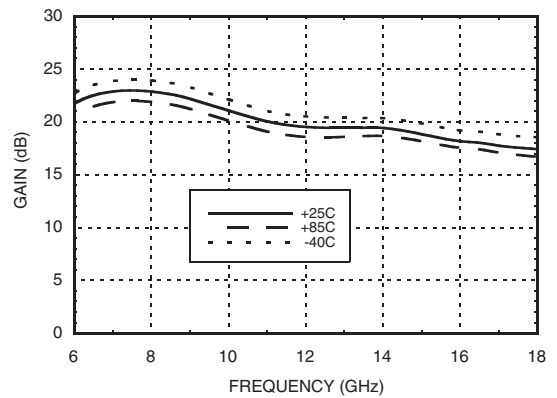

Input Return Loss vs. Temperature

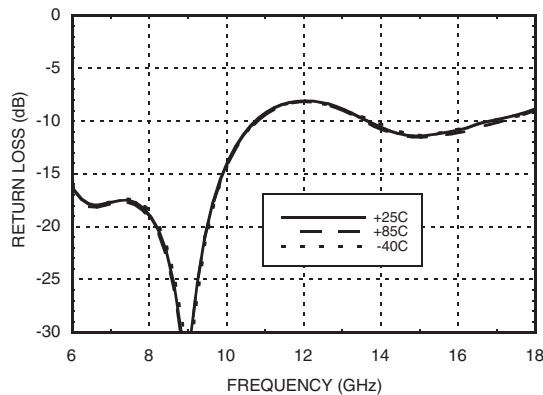

Output Return Loss vs. Temperature

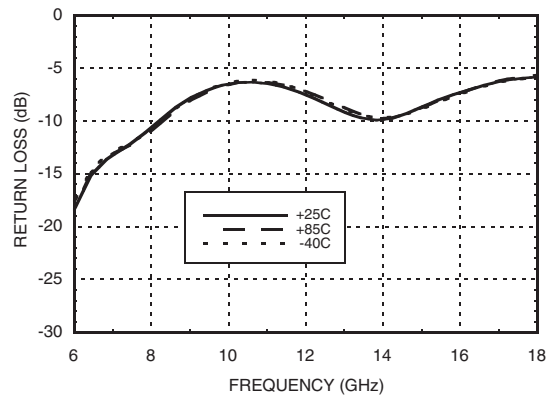



GaAs MMIC ANALOG VARIABLE GAIN AMPLIFIER, 6 - 17 GHz

Return Loss @ Voltage Extreme

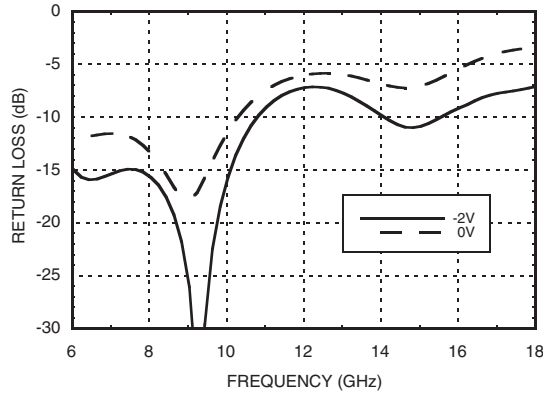

Output Return Loss @ Voltage Extreme

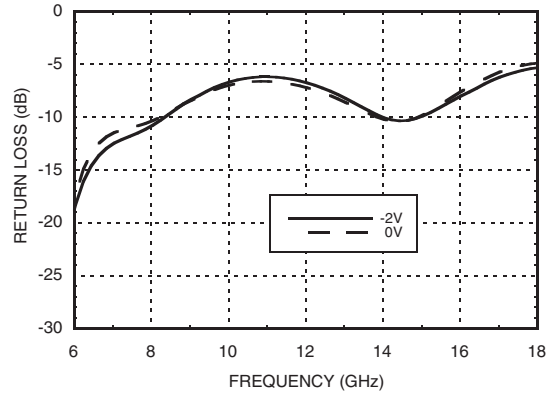

Noise Figure vs. Temperature

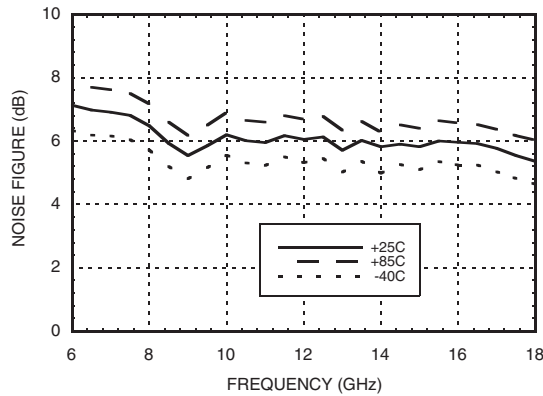

Noise Figure vs. CTRL

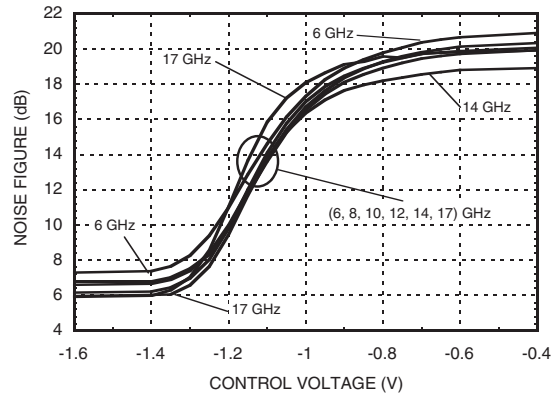

P1dB vs. Temperature

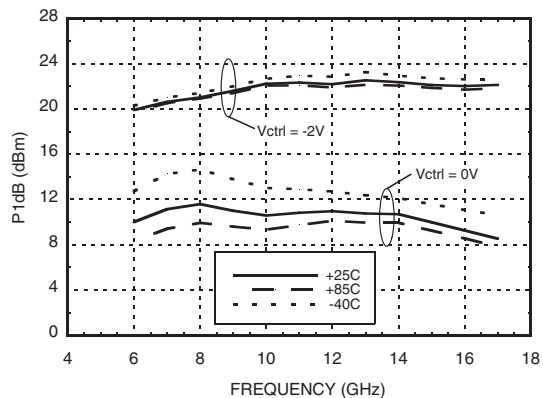

Psat vs. Temperature

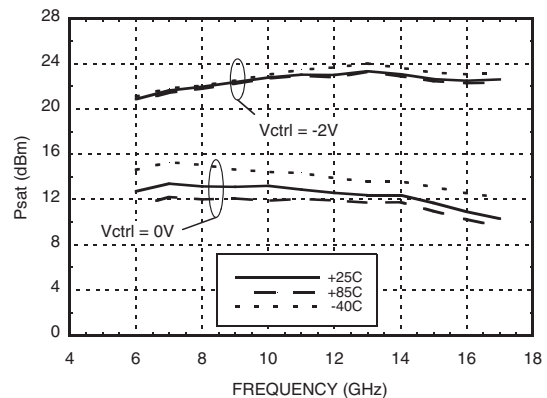

[1] Tested with broadband bias tee on RF ports and C1 = 10,000pF
[2] C1, C6 and C8 = 100pF, L1 = 24nF

GaAs MMIC ANALOG VARIABLE GAIN AMPLIFIER, 6 - 17 GHz

Reverse Isolation vs. Temperature

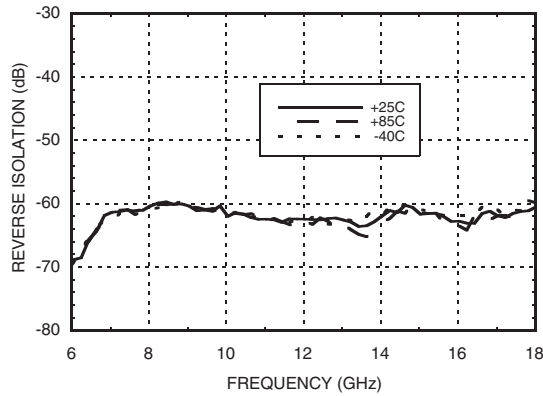

Output IP3 vs. Temperature

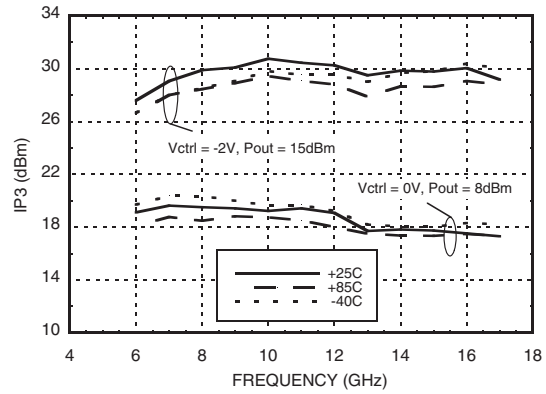

Output IP3 @ 0 dBm

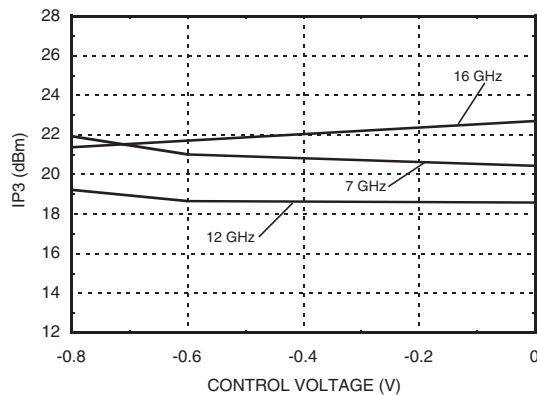

Output IP3 @ 5 dBm

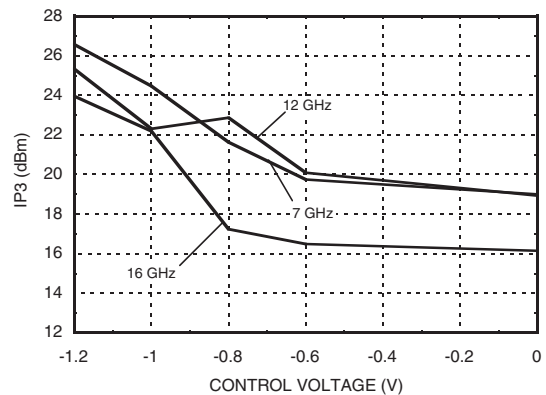

Output IP3 @ 10 dBm

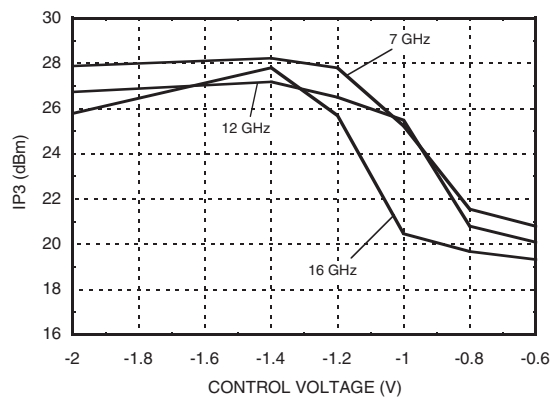

GaAs MMIC ANALOG VARIABLE GAIN AMPLIFIER, 6 - 17 GHz

Absolute Maximum Ratings

Drain Bias Voltage (Vdd1, 2, 3)	+5.5V
Gate Bias Voltage (Vgg1, 2)	-3 to 0V
Gain Control Voltage (Vctrl)	-3 to 0V
RF Power Input	+5 dBm
Channel Temperature	175 °C
Continuous Pdiss (T = 85 °C) (derate 10.2 mW/°C above 85 °C) [1]	0.92 W
Thermal Resistance (Channel to ground paddle)	97.6 °C/W
Storage Temperature	-65 to +150 °C
Operating Temperature	-40 to +85 °C

Bias Voltage

Vdd1,2,3 (V)	Idd Total (mA)
+5.0	170
Vgg1,2 (V)	Igg Total (mA)
0V to -2V	<3 μA



ELECTROSTATIC SENSITIVE DEVICE
OBSERVE HANDLING PRECAUTIONS

Outline Drawing

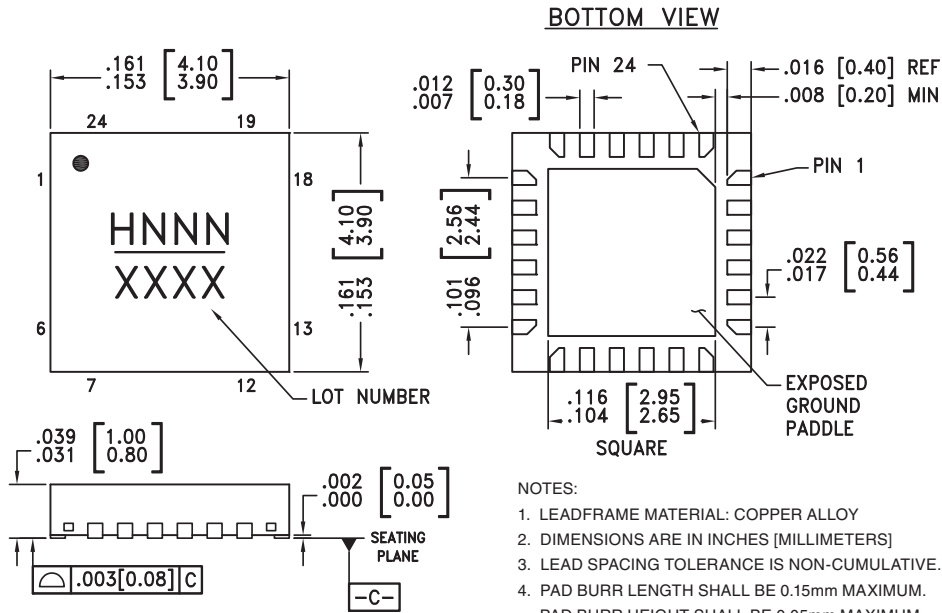

NOTES:

- LEADFRAME MATERIAL: COPPER ALLOY
- DIMENSIONS ARE IN INCHES [MILLIMETERS]
- LEAD SPACING TOLERANCE IS NON-CUMULATIVE.
- PAD BURR LENGTH SHALL BE 0.15mm MAXIMUM.
PAD BURR HEIGHT SHALL BE 0.05mm MAXIMUM.
- PACKAGE WARP SHALL NOT EXCEED 0.05mm.
- ALL GROUND LEADS AND GROUND PADDLE MUST BE SOLDERED TO PCB RF GROUND.
- REFER TO HITTITE APPLICATION NOTE FOR SUGGESTED LAND PATTERN.

Package Information

Part Number	Package Body Material	Lead Finish	MSL Rating	Package Marking [3]
HMC694LP4	Low Stress Injection Molded Plastic	Sn/Pb Solder	MSL1 [1]	H694 XXXX
HMC694LP4E	RoHS-compliant Low Stress Injection Molded Plastic	100% matte Sn	MSL1 [2]	H694 XXXX

[1] Max peak reflow temperature of 235 °C

[2] Max peak reflow temperature of 260 °C

[3] 4-Digit lot number XXXX

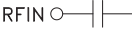
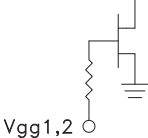
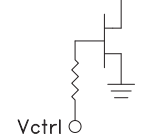
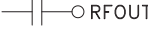
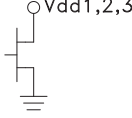

Pin Descriptions

Pad Number	Function	Description	Interface Schematic
1, 2, 6, 8, 10, 11, 13, 17, 18, 20, 21, 23	N/C	No Connection	
3, 5, 14, 16	GND	Die bottom must be connected to RF/DC ground.	
4	RFIN	This pad is AC coupled and matched to 50 Ohm.	
7, 12	Vgg1, 2	Gate control for amplifier. Adjust voltage to achieve typical I _{dd} . Please follow "MMIC Amplifier Biasing Procedure" application note.	
9	Vctrl	Gain control Voltage for the amplifier. See assembly diagram for required external components.	
15	RFOUT	This pad is AC coupled and matched to 50 Ohm.	
19, 22, 24	Vdd1, 2, 3	Drain Bias Voltage for the amplifier. See assembly diagram for required external components	

Application Circuit

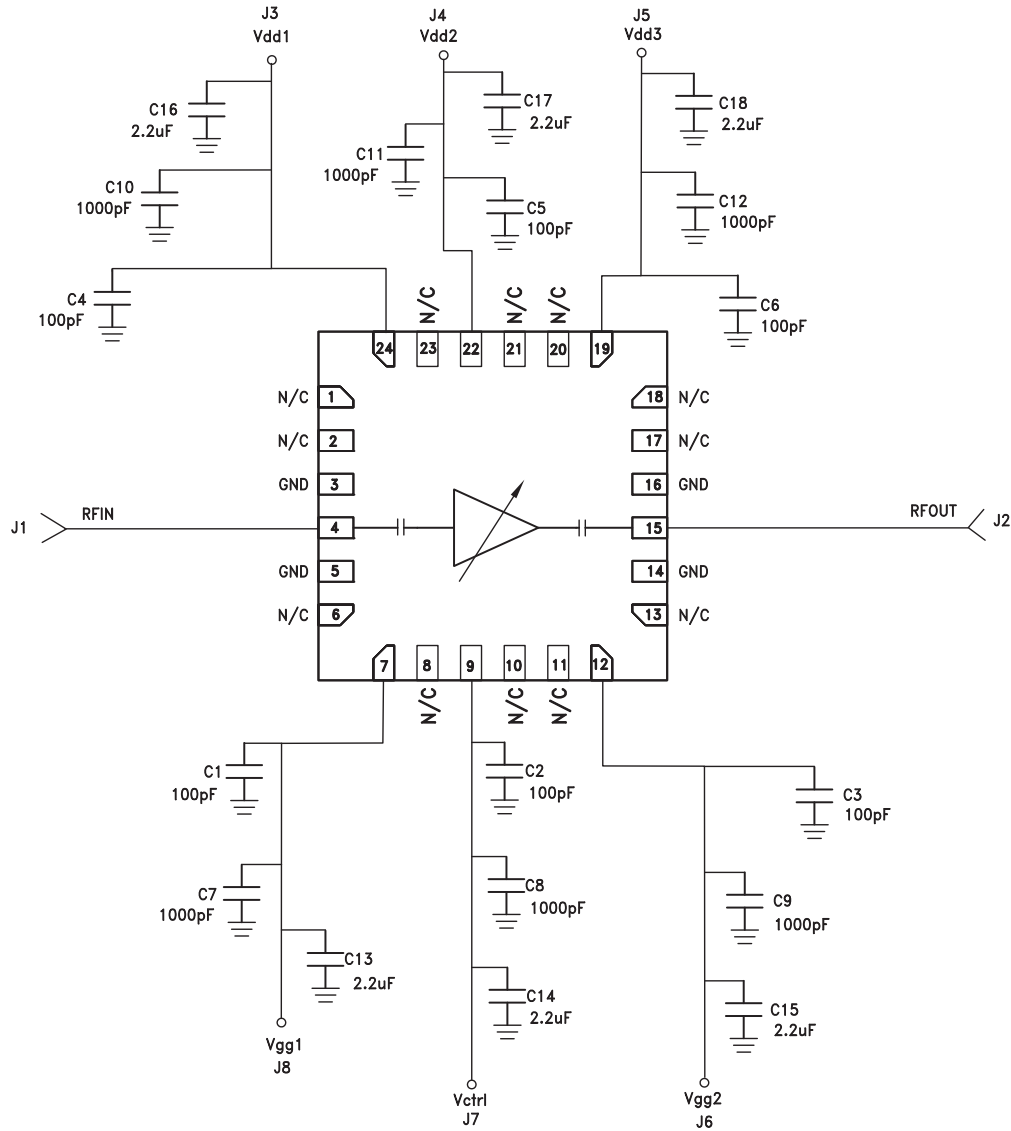

12

VARIABLE GAIN AMPLIFIERS - ANALOG - SMT

Evaluation PCB

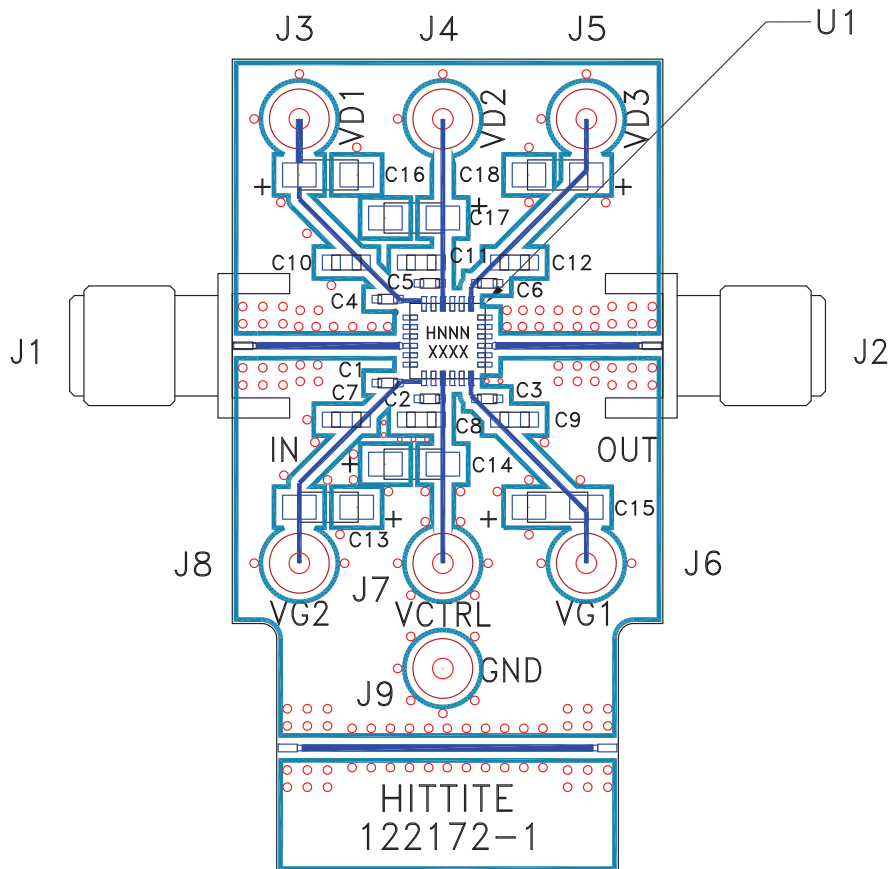

List of Materials for Evaluation PCB 122174 [1]

Item	Description
J1, J2	PCB Mount SMA RF Connectors
J3 - J9	DC Pin
C1 - C6	100 pF Capacitor, 0402 Pkg.
C7 - C12	1000 pF Capacitor, 0603 Pkg.
C13 - C18	2.2 μF Capacitor, CASE A
U1	HMC694LP4(E) Variable Gain Amplifier
PCB [2]	122172 Evaluation PCB

[1] Reference this number when ordering complete evaluation PCB

[2] Circuit Board Material: Arlon 25FR

The circuit board used in the application should use RF circuit design techniques. Signal lines should have 50 Ohm impedance while the package ground leads and exposed paddle should be connected directly to the ground plane similar to that shown. A sufficient number of via holes should be used to connect the top and bottom ground planes. The evaluation circuit board shown is available from Hittite upon request.



Компания «ЭлектроПласт» предлагает заключение долгосрочных отношений при поставках импортных электронных компонентов на взаимовыгодных условиях!

Наши преимущества:

- Оперативные поставки широкого спектра электронных компонентов отечественного и импортного производства напрямую от производителей и с крупнейших мировых складов;
- Поставка более 17-ти миллионов наименований электронных компонентов;
- Поставка сложных, дефицитных, либо снятых с производства позиций;
- Оперативные сроки поставки под заказ (от 5 рабочих дней);
- Экспресс доставка в любую точку России;
- Техническая поддержка проекта, помощь в подборе аналогов, поставка прототипов;
- Система менеджмента качества сертифицирована по Международному стандарту ISO 9001;
- Лицензия ФСБ на осуществление работ с использованием сведений, составляющих государственную тайну;
- Поставка специализированных компонентов (Xilinx, Altera, Analog Devices, Intersil, Interpoint, Microsemi, Aeroflex, Peregrine, Syfer, Eurofarad, Texas Instrument, Miteq, Cobham, E2V, MA-COM, Hittite, Mini-Circuits, General Dynamics и др.);

Помимо этого, одним из направлений компании «ЭлектроПласт» является направление «Источники питания». Мы предлагаем Вам помощь Конструкторского отдела:

- Подбор оптимального решения, техническое обоснование при выборе компонента;
- Подбор аналогов;
- Консультации по применению компонента;
- Поставка образцов и прототипов;
- Техническая поддержка проекта;
- Защита от снятия компонента с производства.



Как с нами связаться

Телефон: 8 (812) 309 58 32 (многоканальный)

Факс: 8 (812) 320-02-42

Электронная почта: org@eplast1.ru

Адрес: 198099, г. Санкт-Петербург, ул. Калинина, дом 2, корпус 4, литера А.