

## FEATURES

- Tracks Multiple Supplies with MOSFET Switches
- Monitors 5 Input Voltages Including  $V_{CC}$
- Guaranteed Threshold Accuracy:  $\pm 1\%$  at 0.5V
- Automatic Remote Sense Switching
- Adjustable Supply Ramp Rate
- Overvoltage Monitor
- Adjustable Electronic Circuit Breaker
- Adjustable Power-Good Delay
- Available for  $V_{CC}$  Supply Voltages of 5V, 3.3V and 2.5V
- Available in 16-Pin Narrow SSOP (LTC2921 Series) and 20-Pin TSSOP (LTC2922 Series)

## APPLICATIONS

- Desktop Computers
- Plug-In Cards
- Telecom Infrastructure
- Supply Sequencing
- Instruments

## DESCRIPTION

The LTC<sup>®</sup>2921 and LTC2922 monitor up to five supplies and force them to track on power-up in multiple supply systems. Using external N-channel pass transistors, the supplies can be ramped up at an adjustable rate. Automatic remote sense switching allows the DC/DC converters to compensate for series voltage drops in the wiring. An incorrect level on one or more of the supplies triggers disconnect of all supplies. Tight 1% accuracy and glitch immunity on the low 0.5V monitoring level ensure no false error disconnects.

The LTC2921 and LTC2922 each feature an adjustable electronic circuit breaker to protect the  $V_{CC}$  supply against short circuits. Capacitance at the TIMER pin programs the delays in the monitoring sequence.

The LTC2921 includes three remote sense switches in a 16-pin narrow SSOP package, while the LTC2922 includes five remote sense switches in a 20-pin TSSOP package. Both parts are available for  $V_{CC}$  supply voltages of 5V, 3.3V, and 2.5V.

 LTC and LT are registered trademarks of Linear Technology Corporation.

## TYPICAL APPLICATION

Three-Supply Tracker and Monitor (5V, 3.3V, 2.5V)

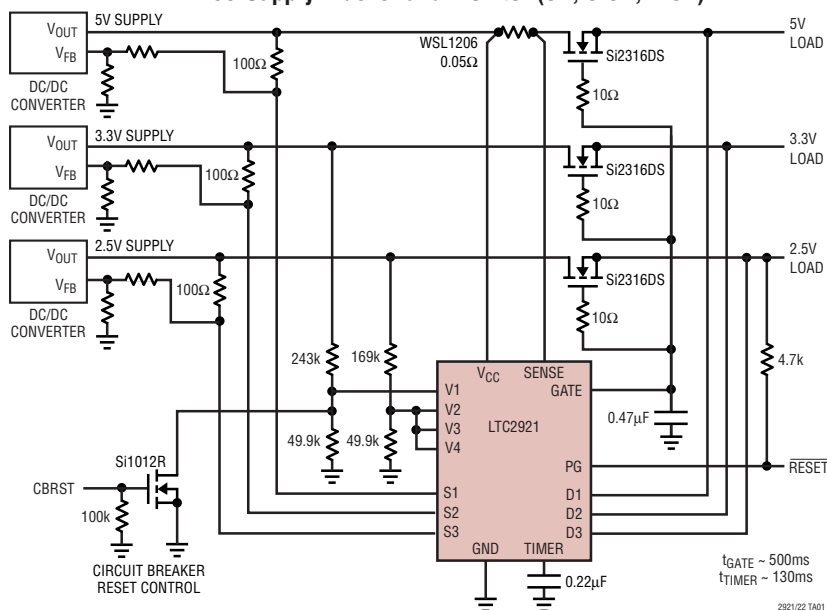

Load Voltage Ramp-Up and Power-Good Activation



# LTC2921/LTC2922 Series

## ABSOLUTE MAXIMUM RATINGS (Note 1)

$V_{CC}$ Supply Voltage	-0.3V to 7V	Switch Currents (DC, RMS)	
V1, V2, V3, V4 Voltages	-0.3V to 7V	S0, D0, S4, D4 (LTC2922 Series)	30mA
SENSE Voltage	-0.3V to 7V	S1, D1, S2, D2, S3, D3	30mA
TIMER Voltage	-0.3V to ( $V_{CC} + 0.3V$ )	Operating Ambient Temperature Range	
Charge Pumped Output Voltages		LTC2921C/LTC2922C	0°C to 70°C
GATE, PG	-0.3V to 12.2V	LTC2921I/LTC2922I	-40°C to 85°C
Switch Voltages		Junction Temperature (Note 2)	125°C
S0, D0, S4, D4 (LTC2922 Series)	-0.3V to 7V	Storage Temperature Range	-65°C to 150°C
S1, D1, S2, D2, S3, D3	-0.3V to 7V	Lead Temperature (Soldering, 10 sec)	300°C

## PACKAGE/ORDER INFORMATION

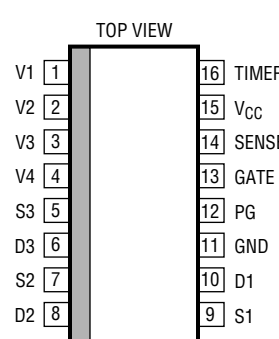
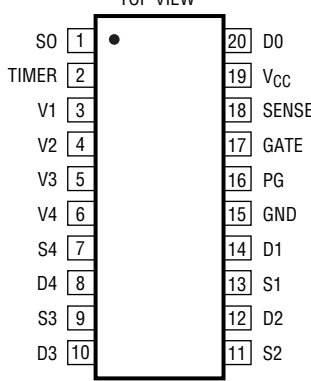
TOP VIEW	ORDER PART NUMBER	TOP VIEW	ORDER PART NUMBER
 <p>GN PACKAGE 16-LEAD NARROW PLASTIC SSOP <math>T_{JMAX} = 125^{\circ}C, \theta_{JA} = 110^{\circ}C/W</math></p>	LTC2921CGN LTC2921CGN-3.3 LTC2921CGN-2.5 LTC2921IGN LTC2921IGN-3.3 LTC2921IGN-2.5	 <p>F PACKAGE 20-LEAD PLASTIC TSSOP <math>T_{JMAX} = 125^{\circ}C, \theta_{JA} = 90^{\circ}C/W</math></p>	LTC2922CF LTC2922CF-3.3 LTC2922CF-2.5 LTC2922IF LTC2922IF-3.3 LTC2922IF-2.5
	GN PART MARKING		
	2921 292133 292125 29211 921133 921125		

Consult LTC Marketing for parts specified with wider operating temperature ranges.

## ELECTRICAL CHARACTERISTICS

The ● denotes the specifications which apply over the full operating temperature range, otherwise specifications are at  $T_A = 25^{\circ}C$ .  $V_{CC} = 5V$  for LTC2921/LTC2922,  $V_{CC} = 3.3V$  for LTC2921-3.3/LTC2922-3.3, and  $V_{CC} = 2.5V$  for LTC2921-2.5/LTC2922-2.5, unless otherwise noted.

SYMBOL	PARAMETER	CONDITIONS	MIN	TYP	MAX	UNITS
<b>Supply Pin</b>						
$V_{CC}$	Supply Voltage	Typical Operating Range LTC2921/LTC2922	4.50	5.00	5.50	V
		LTC2921-3.3/LTC2922-3.3	2.97	3.30	3.63	V
		LTC2921-2.5/LTC2922-2.5	2.37	2.50	2.63	V
$I_{CC}$	Supply Current			2		mA
$V_{CC(MON)}$	Supply Monitor Threshold Voltage	LTC2921/LTC2922	● 4.285	4.350	4.415	V
		LTC2921-3.3/LTC2922-3.3	● 2.828	2.871	2.914	V
		LTC2921-2.5/LTC2922-2.5	● 2.265	2.300	2.335	V
$V_{CC(OV)}$	Supply Overvoltage Threshold	LTC2921/LTC2922	● 5.82	6.13	6.43	V
		LTC2921-3.3/LTC2922-3.3	● 3.84	4.04	4.24	V
		LTC2921-2.5/LTC2922-2.5	● 3.08	3.24	3.40	V

29212fa

## ELECTRICAL CHARACTERISTICS

The ● denotes the specifications which apply over the full operating temperature range, otherwise specifications are at  $T_A = 25^\circ\text{C}$ .  $V_{CC} = 5\text{V}$  for LTC2921/LTC2922,  $V_{CC} = 3.3\text{V}$  for LTC2921-3.3/LTC2922-3.3, and  $V_{CC} = 2.5\text{V}$  for LTC2921-2.5/LTC2922-2.5, unless otherwise noted.

SYMBOL	PARAMETER	CONDITIONS		MIN	TYP	MAX	UNITS
$V_{CC(UVLO)}$	Supply Undervoltage Lockout	$V_{CC}$ Rising	●	2.08	2.20	2.30	V
$V_{CC(UVH)}$	Supply Undervoltage Hysteresis	$V_{CC}$ Falling			120		mV
<b>Electronic Circuit Breaker</b>							
$\Delta V_{SENSE}$	Circuit Breaker Trip Voltage	$\Delta V_{SENSE} = V_{CC} - V_{SENSE}$	●	45	50	55	mV
$I_{SENSE}$	SENSE Pin Input Current				150	500	nA
$t_{V1(DLY)}$	Circuit Breaker Trip Delay Time	$V_{CC} - V_{SENSE} = 150\text{mV}$ LTC2921/LTC2922 LTC2921-3.3/LTC2922-3.3 LTC2921-2.5/LTC2922-2.5		0.5 0.5 0.5	1.5 1.5 1.5	3.0 3.0 6.0	$\mu\text{s}$ $\mu\text{s}$ $\mu\text{s}$
$t_{V1(RST)}$	Circuit Breaker Reset Pulse Width	Guaranteed Not to Reset Guaranteed to Reset	● ●	150		50	$\mu\text{s}$ $\mu\text{s}$
$V_{V1(RST)}$	Circuit Breaker Reset Threshold Voltage		●	0.490	0.500	0.510	V
<b>Monitor Inputs</b>							
$V_{MON}$	V1-V4 Monitor Threshold Voltages		●	0.495 0.492	0.500 0.500	0.505 0.508	V V
$V_{OV}$	V1-V4 Overvoltage Thresholds		●	0.665	0.700	0.735	V
$I_{MON}$	V1-V4 Input Currents					$\pm 0.1$	$\mu\text{A}$
<b>TIMER Pin</b>							
$V_{TIMER(TH)}$	TIMER Ramp Threshold Voltage		●	1.15	1.20	1.25	V
$I_{TIMER(PU)}$	TIMER Pull-Up Current	$V_{TIMER} = 1\text{V}$	●	-1.3	-2.0	-2.5	$\mu\text{A}$
$I_{TIMER(PD)}$	TIMER Pull-Down Current	$V_{CC} = 2.35\text{V}$ , $V_{TIMER} = 0.4\text{V}$		100			$\mu\text{A}$
$V_{TIMER(CLR)}$	TIMER Cleared Threshold Voltage	$V_{TIMER}$ Falling			150	250	mV
<b>GATE Pin</b>							
$V_{GATE}$	GATE Drive Output Voltage	LTC2921/LTC2922 LTC2921-3.3/LTC2922-3.3 LTC2921-2.5/LTC2922-2.5	● ● ●	10.0 8.4 6.1	11.1 9.1 6.8	12.2 9.8 7.5	V V V
$I_{GATE(PU)}$	GATE Pull-Up Current	$V_{GATE} = V_{CC}$	●	-6.5	-10.0	-12.5	$\mu\text{A}$
$I_{GATE(PD)}$	GATE Pull-Down Current	$V_{CC} = 2.35\text{V}$ , $V_{GATE} = 2.35\text{V}$		10			mA
<b>Remote Sense Switches</b>							
$R_{DS(FB)}$	Feedback Switch Resistances (Note 3)	$V_D = V_{CC}$	●		2	10	$\Omega$
<b>PG Pin</b>							
$I_{PG(PU)}$	PG Pull-Up Current	$V_{PG} = V_{CC}$	●	-2.6	-4.0	-5.0	$\mu\text{A}$
$I_{PG(PD)}$	PG Pull-Down Current	$V_{CC} = 2.35\text{V}$ , $V_{PG} = 2.35\text{V}$		10			mA
$V_{PG(OL)}$	PG Output Low Voltage	$V_{CC} = 2.35\text{V}$ , $I_{PG} = 5\text{mA}$	●			0.4	V
$V_{PG}$	PG Output Voltage (Note 4)	LTC2921/LTC2922 LTC2921-3.3/LTC2922-3.3 LTC2921-2.5/LTC2922-2.5	● ● ●	10.0 8.4 6.1	11.1 9.1 6.8	12.2 9.8 7.5	V V V

**Note 1:** Absolute Maximum Ratings are those values beyond which the life of a device may be impaired.

**Note 2:**  $T_J$  is calculated from the ambient temperature  $T_A$  and power dissipation  $P_D$  as follows:

$$\text{LTC2921 Series: } T_J = T_A + (P_D \cdot 110^\circ\text{C/W})$$

$$\text{LTC2922 Series: } T_J = T_A + (P_D \cdot 90^\circ\text{C/W})$$

**Note 3:** This specification applies to all switches, and is measured with  $V_S < V_D$ .

**Note 4:** The PG pin will rise to approximately the same voltage as the GATE pin when not pulled up or pulled down by external resistance.

# LTC2921/LTC2922 Series

## TYPICAL PERFORMANCE CHARACTERISTICS

Specifications are at  $T_A = 25^\circ\text{C}$  unless otherwise noted.

**Supply Current vs Supply Voltage**



2921/2 G01

**Supply Current vs Temperature**



2921/2 G02

**Monitor Trip Delay vs Monitor Input Overdrive**



2921/2 G03

**Monitor Input Threshold vs Temperature**



2921/2 G04

**Circuit Breaker Trip Voltage vs Temperature**

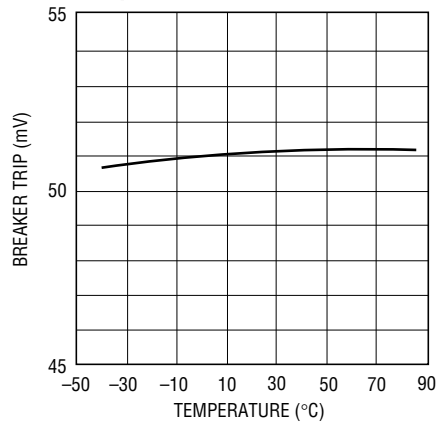

2921/2 G05

**SENSE Input Current vs Temperature**



2921/2 G06

**TIMER Trip Voltage vs Temperature**



2921/2 G07

**TIMER Pull-Up Current vs Temperature**

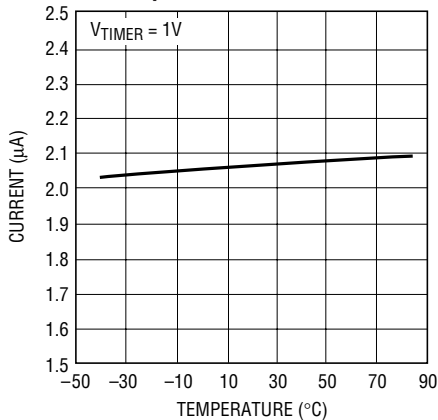

2921/2 G08

**TIMER Pull-Down Current vs Supply Voltage**

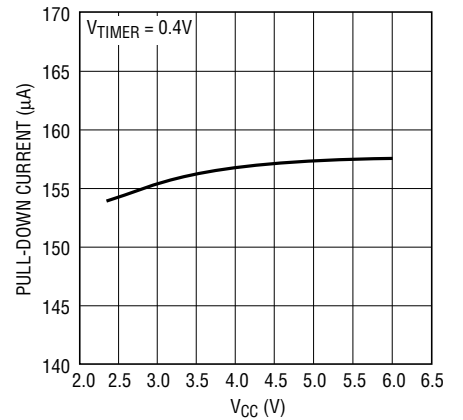

2921/2 G09

## TYPICAL PERFORMANCE CHARACTERISTICS

Specifications are at  $T_A = 25^\circ\text{C}$  unless otherwise noted.

### Gate Voltage vs Supply Voltage

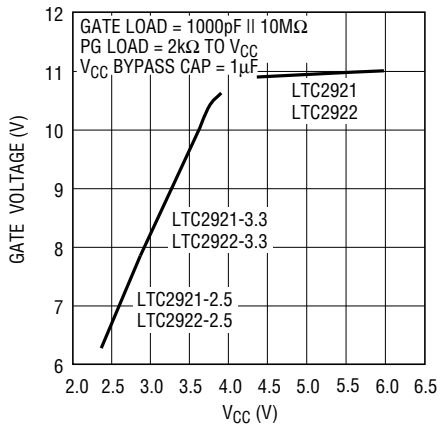

### Gate Voltage vs Temperature



### Gate Voltage vs Load Current



### GATE Pull-Up Current vs Temperature



### PG Voltage vs Supply Voltage



### PG Pull-Up Current vs Temperature



## **PIN FUNCTIONS** (LTC2921/LTC2922 or [LTC2922 Only])

**S0, D0 (Pins 1, 20 [LTC2922]):** Remote Switch 0. These pins are the terminals of an internal N-channel FET switch that is enabled after the GATE pin is fully ramped up. This switch can be used to connect a remote sense line to compensate for IR drop across the external FETs. The gate of the internal switch ramps up at a nominal rate of 8V/ms. The pins are interchangeable, either switch pin can be tied to the load side. Tie both pins to ground if unused.

**S4, D4 (Pins 7, 8 [LTC2922]):** Remote Sense Switch 4. Tie to GND if unused.

**S3, D3 (Pins 5, 6/Pins 9, 10):** Remote Sense Switch 3. Tie to GND if unused.

**S2, D2 (Pins 7, 8/Pins 11, 12):** Remote Sense Switch 2. Tie to GND if unused.

**S1, D1 (Pins 9, 10/Pins 13, 14):** Remote Sense Switch 1. Tie to GND if unused.

**TIMER (Pin 16/Pin 2):** Timing Delay Input. Connect a capacitor between this pin and ground to set a 600ms/ $\mu$ F delay at two points in the monitoring sequence. This sets the delay after all monitors are good, before the start of GATE ramping, and the delay after the remote sense switches are on, before PG is activated. TIMER must fall below 150mV before a timing delay can start. The TIMER pin is pulled to ground at other points in the sequence.

**V1-V4 (Pins 1-4/Pins 3-6):** Supply Monitor Inputs. All four inputs must lie above the monitor threshold level (0.5V) and below the monitor overvoltage level (0.7V) for a turn-on sequence to commence or continue. When any monitor input falls outside those levels, the GATE and PG pins are pulled low, disconnecting all the loads. Glitch filtering on the 0.5V monitor threshold prevents low-energy voltage spikes from affecting the comparators' results. V1 also serves as an active-low reset pin for the circuit breaker. Tie unused monitor inputs to used monitor inputs.

**GND (Pin 11/Pin 15):** Circuit Ground.

**PG (Pin 12/Pin 16):** Power Good Output. A 4 $\mu$ A current source from the internal charge pump rail ( $V_{PUMP}$ ) pulls PG up after the turn-on sequence is complete. The output is pulled to ground before turn-on is complete, when any monitor is out of compliance, when the circuit breaker trips, and when  $V_{CC}$  is undervoltage. An external resistor can be added to pull up to a lower voltage and to improve pull up speed. This pin can also be configured as a gate drive for external N-channel FETs in sequencing applications. In applications not requiring the PG output, leave the pin unconnected.

**GATE (Pin 13/Pin 17):** Gate Drive for External N-Channel FETs. A 10 $\mu$ A current source from the internal charge pump rail ( $V_{PUMP}$ ) ramps the gates of the external N-channel MOSFETs forcing all supplies to track on. The resistor and capacitor network from this pin to ground sets the supplies' ramp rate and enhances control loop stability.

**SENSE (Pin 14/Pin 18):** Circuit Breaker Sense Input. An external resistor between  $V_{CC}$  and SENSE sets the electronic circuit breaker trip current. The breaker trips when the voltage across the resistor exceeds 50mV for 1 $\mu$ s. To disable the circuit breaker tie SENSE to  $V_{CC}$ . To reset the circuit breaker after the current falls below the trip point, pull the V1 pin below 0.5V for >150 $\mu$ s or go into undervoltage lockout for >10 $\mu$ s.

**V<sub>CC</sub> (Pin 15/Pin 19):** Supply Voltage. The voltage at  $V_{CC}$  is monitored through an internal resistive divider in a manner similar to the V1-V4 inputs. An undervoltage lockout circuit disables the part until the voltage at  $V_{CC}$  is greater than 2.2V. The  $V_{CC}$  pin must be connected to the highest supply voltage. Bypass the  $V_{CC}$  pin to ground with a 10 $\mu$ F capacitor.



## OPERATION

### General Operation

The LTC2921 and LTC2922 track multiple supplies, monitor multiple inputs, and provide integrated switches for remote sensing. Once all input voltages lie between monitoring and overvoltage threshold levels, in-line FETs are turned on to simultaneously ramp power to the loads. The automatic remote sense switches are then activated, and the power good signal is asserted. After initial power-on the LTC2921 and LTC2922 continue monitoring the inputs. Several types of events will trigger interruption, any of which will disconnect all supplies, deactivate the power good signal, and open the remote sense switches.

### Monitoring Sequence

A normal power-on sequence comprises the following steps:

Step 0) Wait for  $V_{CC}$  to exceed the undervoltage lockout threshold. Continue checking  $V_{CC}$ .

Step 1) Confirm that the circuit breaker has not tripped and wait for all monitored supplies, including  $V_{CC}$ , to be between their programmed monitor and overvoltage thresholds. Continue checking these conditions.

Step 2) Check that the TIMER pin voltage starts below 150mV. Create a delay by ramping up the TIMER pin until it trips an internal comparator.

Step 3) Ramp the GATE pin to turn on the external N-channel FETs, simultaneously ramping the supplies into their loads. Await confirmation of full GATE enhancement, i.e., GATE voltage within  $\sim 1V$  of  $V_{PUMP}$ . Continue checking this condition.

Step 4) Activate the remote sense switches. Await confirmation of full Feedback Switch Gate enhancement.

Step 5) Wait again for another TIMER cycle delay.

Step 6) Release the pull-down on the PG output. Continue checking  $V_{CC}$ , the circuit breaker, the input voltages, and the GATE voltage.

### Interrupting Events

Three events can interrupt the sequence and trigger immediate disconnect of all supplies, pull-down of the PG

signal, and deactivation of the remote sense switches. The three interrupting events are a lockout, a fault, and an error.

A lockout occurs when  $V_{CC}$  falls below the undervoltage threshold (including hysteresis). Escape from lockout requires sufficient  $V_{CC}$  voltage. Leaving lockout, the sequence begins at Step 1. A lockout condition supersedes faults and errors.

A fault occurs when the circuit breaker trips. Escape from a fault requires pulsing the V1 pin below the reset threshold of 0.5V(nom) for more than 150 $\mu$ s after the current falls below the trip point. When V1 returns high, the sequence begins from Step 1. An undervoltage lockout of  $>10\mu$ s also clears the circuit breaker fault latch. A fault condition supersedes errors.

An error occurs when one or more of the monitor inputs (V1-V4 pins) or  $V_{CC}$  falls below its monitor threshold, or rises above its overvoltage threshold. A loss of voltage on the GATE pin, once it has fully ramped up, also causes an error. An error sends the sequence to Step 1.

### Feedback Switches for Remote Sensing

The integrated N-channel switches of the LTC2921/LTC2922 automatically compensate for the voltage drops caused by the  $R_{DS(ON)}$  of the external load-control MOSFET switches. This is accomplished by modifying the normal feedback path of each power supply that is controlled by the LTC2921/LTC2922. When the load-control switches are off, the remote sense switches are also off, and the power supply uses its normal feedback path to sense its output voltage. After the load-control switches are turned on, the remote sense switches are turned on to create dominating feedback paths. The feedback loops include the load-control switches, thus compensating for their voltage drops.

In order to eliminate glitching on the output of the power supply, the remote sense switches are turned on at a controlled rate of about 8V/ms. The gates of these integrated N-channel devices are pulled up above  $V_{CC}$  to  $V_{PUMP}$  so as to provide a low-resistance path for a wide range of voltages.



## OPERATION

### Electronic Circuit Breaker

Placing a resistor between the  $V_{CC}$  and SENSE pins allows the part to detect shorts and excessive currents on the  $V_{CC}$  supply. The electronic circuit breaker trips when the voltage across the resistor is  $>50\text{mV}$  for more than  $1\mu\text{s}$ . A trip causes a fault condition which interrupts the monitor

sequence, and which requires reset of the circuit breaker latch (see Interrupting Events section). Breaker reset is achieved by pulling  $V1$  below the reset threshold for  $>150\mu\text{s}$  after the current falls below the trip point, or by returning from undervoltage lockout on  $V_{CC}$ .

## TIMING DIAGRAMS

The timing of a typical start-up sequence for the LTC2921/LTC2922 is shown in Figure 2.  $V_{CC}$  exceeds the undervoltage lockout level at time 0. All monitor inputs settle between the  $0.5\text{V}$  monitor threshold and the  $0.7\text{V}$  overvoltage threshold by time 1, then a TIMER cycle starts. The TIMER pin reaches  $1.2\text{V}$  at time 2, and GATE ramping begins. When the GATE ramp completes at time 3, the automatic remote sense switches close. Another TIMER delay begins at time 4 and finishes at time 5, at which time PG is activated.

The timing of a monitor failure and subsequent regular turn-on is shown in Figure 3. Prior to time 1, a successful turn-on sequence had completed. At time 1, monitor  $V2$  falls below the  $0.5\text{V}$  reference, triggering an error. The GATE pin, PG pin, and the remote sense switches fall at rates determined by the pull-down currents and loading conditions of each (times 2, 3, 4). At time 5, monitor  $V2$  recovers, and a normal turn-on sequence begins.



Figure 2. Typical Start-Up Sequence



Figure 3. Monitor Failure and Start-Up Sequence Timing

## TIMING DIAGRAMS

The timing of a circuit breaker trip and reset, and a subsequent regular turn-on are shown in Figure 4. Prior to time 1, a successful turn-on sequence had completed. At time 1, excessive current pulls SENSE more than 50mV below  $V_{CC}$ . The GATE pin, PG pin, and the remote sense switches fall at rates determined by the pull-down currents

and loading conditions of each (times 2, 3, 4). Note that the excessive current condition ceases at time 4. A circuit breaker reset pulse is initiated at time 5. The latch resets at time 6 since the V1 pulse is wide enough. A normal turn-on begins when V1 rises above the monitor threshold (time 7 onward).

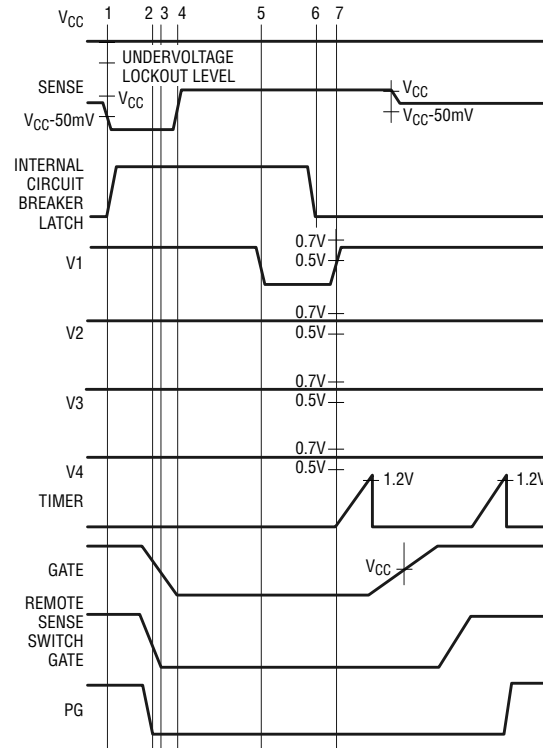

Figure 4. Circuit Breaker Trip, Reset and Start-Up Sequence Timing

## APPLICATIONS INFORMATION

Multiple supply systems have become common to accommodate circuits on the same board with different voltage requirements. Desktop PC motherboards, instrumentation circuits and plug-in boards of all kinds often require tracking and control of several supply voltages.

The LTC2921 and LTC2922 ramp and monitor up to five supply voltages in such systems. External resistive voltage dividers independently program four monitor levels, while an internal divider sets the  $V_{CC}$  pin supply monitor level. Time delays in the monitoring sequence are set by an external capacitor at the TIMER pin.

The GATE pin provides a high side drive voltage appropriate to logic-level and sublogic-level N-channel power

MOSFETs. The external RC network on GATE programs the supply ramp rate and eliminates possible high frequency oscillations in the power path. Featured in the LTC2921/LTC2922 series are sub- $10\Omega$  internal remote sense switches to compensate for voltage drops between the supplies and the loads.

At the end of a successful power-on sequence, the LTC2921/LTC2922 asserts the PG output. A typical application uses an external pull-up resistor between PG and the load side of a supply. In applications where supply power-on sequencing is required, the PG pin can function as a second, separate high side driver.

## APPLICATIONS INFORMATION

### Setting the Supply Monitor Levels

The LTC2921 and LTC2922 series both feature low 0.5V monitoring thresholds with tight 1% accuracy. To set a supply monitoring level tightly, design a precision ratio resistive divider to relate the lowest valid supply voltage to the maximum specified monitor threshold voltage. Use resistors with 1% tolerance or better to limit the error due to mismatch. The basic resistive divider connection for supply monitoring is shown in Figure 5.



Figure 5. Basic Monitor Connection

First, divide the nominal monitor threshold voltage by an acceptable bias current ( $I_{A1}$ ), and choose a nearby standard value for resistor  $R_{A1}$  (see Equation 1).

Next, calculate the bounds on the value of  $R_{B1}$  that guarantee that the divided minimum supply voltage exceeds the maximum specified monitor threshold voltage, and that the minimum specified overvoltage threshold exceeds the divided maximum supply voltage. Use Equations 2 and 3 to calculate  $R_{B1(MAX)}$  and  $R_{B1(MIN)}$  from  $R_{A1}$ , the resistor tolerance (RTOL), the supply voltage, the monitor threshold and overvoltage specifications, and the monitor pin leakage current specification.

When the integrated remote sensing switch is closed, the DC/DC converter will compensate for the IR drop from drain to source of the external N-channel FET ( $V_{Q1(ON)}$ ) by increasing the supply voltage by the same amount. Calculate with  $V_{Q1(ON)(MAX)} = 0V$  if the remote sense switch is not used.

$$R_{A1} = \frac{0.500V}{I_{A1}} \quad (1)$$

$$R_{B1(MAX)} = R_{A1} \cdot \left( \frac{1-RTOL}{1+RTOL} \right) \cdot \left( \frac{V_{SRC1(MIN)} - 0.505V}{0.505V + 0.1\mu A \cdot R_{A1}} \right) \quad (2)$$

$$R_{B1(MIN)} = R_{A1} \cdot \left( \frac{1+RTOL}{1-RTOL} \right) \cdot \left( \frac{V_{SRC1(MAX)} + V_{Q1(ON)(MAX)} - 0.665V}{0.665V - 0.1\mu A \cdot R_{A1}} \right) \quad (3)$$

Choose a standard resistor value for  $R_{B1}$  that satisfies the inequality of Equation 4.

$$R_{B1(MIN)} \leq R_{B1} \leq R_{B1(MAX)} \quad (4)$$

When several standard values meet the requirement, choose the value closest to  $R_{B1(MAX)}$  to set the tightest monitor threshold. This also allows more headroom for larger  $V_{Q1(ON)(MAX)}$ . Alternatively, choose the standard value closest to  $R_{B1(MIN)}$  to set the tightest overvoltage threshold.

All four monitor input voltages must be between the monitor threshold and the overvoltage threshold for the turn-on sequence to begin. Connect unneeded monitor input pins to any of the utilized monitor input pins.

### Selecting the External N-Channel MOSFETs

The GATE pin drives the gate of external N-channel MOSFETs above  $V_{CC}$  to connect the supplies to the loads. The GATE drive voltage provided by the LTC2921/LTC2922 series is best suited to logic-level and sublogic-level power MOSFETs. To achieve the lowest switch resistance, the  $V_{CC}$  pin must be connected to the highest supply voltage.

Consider the application requirements for current, turnoff speed, on-resistance, gate-source voltage specification, etc. Refer to the Electrical Specifications and Typical Performance Curves to determine the GATE voltages for given  $V_{CC}$  voltages over the required range of conditions. Calculate the minimum gate drive voltage for each monitored supply for use in selecting the FETs. Check the maximum GATE voltage against the FETs' gate-source

## APPLICATIONS INFORMATION

voltage specifications. On-resistance is a critical parameter when choosing power MOSFETs. The integrated remote sense switches compensate for IR drops, but minimizing  $V_{Q(MAX)}$  leaves more margin for designing the resistive voltage divider for the monitors.

### Setting the GATE Ramp Rate

Application of power to the loads is controlled by setting the voltage ramping rate with an external capacitor on the GATE pin. During Step 3 of the monitoring sequence, a  $10\mu\text{A}$  pull-up ramps the GATE pin capacitance up to  $V_{PUMP}$ , the internal charge pump voltage. Use Equation 5 to calculate the nominal GATE pin capacitance necessary to achieve a given ramp rate,  $\Delta V/\Delta t$ :

$$C_{GATE} = \frac{10\mu\text{A}}{\Delta V / \Delta t} \quad (5)$$

Alternatively, to calculate the GATE capacitor to achieve a desired nominal ramp time, use Equation 6. The GATE drive voltage ( $V_{GATE}$ ) varies with  $V_{CC}$  voltage. Consult the Electrical Characteristics table and Typical Performance curves to choose an appropriate value to insert for  $V_{GATE}$ .

$$C_{GATE} = \frac{10\mu\text{A} \cdot t_{RAMP}}{V_{GATE}} \quad (6)$$

When the GATE pin drives several FETs in parallel, the load voltages ramp together at the same rate until the lowest supply reaches its full value. The other supplies continue to track until the next lowest supply reaches its full value, and so on.

The GATE pin must not be forced above the level it reaches when fully ramped. An internal clamp limits the GATE voltage to  $\leq 12.2\text{V}$  relative to ground.

Damp possible ramp-on oscillations by including a  $10\Omega$  resistor in series with each external N-channel gate, and as necessary, a  $0.1\mu\text{F}$  capacitor on each external N-channel drain, as shown in Figure 6.

### Setting the Sequence Delay Timer

The turn-on sequence includes two programmable delays set by the capacitance on the TIMER pin. More precisely, a single delay value is used at two points in the sequence.



Figure 6. Ramping and Damping Components on GATE Pin

In both cases, the delay provides a measure of confidence that conditions are stable enough for the sequence to advance.

The first TIMER delay begins once all monitor voltages comply with their thresholds, the electronic circuit breaker has not tripped, and  $V_{CC}$  is not undervoltage. The TIMER pin sources  $2\mu\text{A}$  into an external capacitor, which ramps its voltage. A comparator trips when the TIMER pin voltage reaches the internal  $1.2\text{V}$  reference, then the GATE ramp begins, and TIMER is pulled to ground. The second TIMER delay begins after the gate of the remote sense switches is fully ramped up. After the TIMER ramp completes, the PG pin is activated. An internal circuit pulls-down the TIMER pin with  $>100\mu\text{A}$  of current at all times, except during the ramping periods, and when  $V_{CC}$  is undervoltage.

Calculate the nominal value for the timing capacitor by inserting the desired delay into Equation 7:

$$C_{TIMER} = \frac{2\mu\text{A}}{1.2\text{V}} \cdot t_{DLY} \quad (7)$$

For delay times below  $60\mu\text{s}$ , be sure to limit stray capacitances on the TIMER pin by using good PCB design practices. To program essentially no delay ( $<1\mu\text{s}$ ), float the TIMER pin.

Internal circuitry guarantees that the TIMER pin is pulled below  $150\text{mV}$  (typical) before a delay cycle can begin.

## APPLICATIONS INFORMATION

### Electronic Circuit Breaker

The LTC2921/LTC2922's electronic circuit breaker protects against excessive current on  $V_{CC}$ . The circuit breaker trips when the SENSE pin falls more than 50mV below the  $V_{CC}$  pin for more than 1 $\mu$ s. When the breaker trips, the remote sense switches are opened and the PG and GATE pins are pulled to ground, disconnecting the supplies. An internal latch guarantees that the monitoring sequence cannot start until the breaker is reset. To reset the circuit breaker, cycle the V1 input below 0.5V(nom) for more than 150 $\mu$ s.  $V_{CC}$  falling below the undervoltage threshold also resets the breaker. After reset, the sequence returns to Step 1, awaiting valid monitor levels.

Figure 7 shows an equivalent schematic for the electronic circuit breaker function. Using Equation 8, set the circuit breaker by selecting  $R_{SENSE}$  to drop less than the minimum  $\Delta V_{SENSE}$  at the desired trip current:

$$R_{SENSE} \leq \frac{\Delta V_{SENSE(MIN)}}{I_{LO(TRIP)}} \quad (8)$$

After selecting a resistor, use Equations 9a and 9b to calculate the actual minimum and maximum trip current threshold limits:

$$I_{TRIP(MIN)} = \frac{\Delta V_{SENSE(MIN)}}{R_{SENSE(MAX)}} \quad (9a)$$

$$I_{TRIP(MAX)} = \frac{\Delta V_{SENSE(MAX)}}{R_{SENSE(MIN)}} \quad (9b)$$



Figure 7. Circuit Breaker Functional Schematic

Be mindful of thermal effects and power ratings when choosing a resistor. Place  $R_{SENSE}$  as close as possible to the LTC2921/LTC2922 pins to reduce noise pickup, and use Kelvin sensing to ensure accurate measurement of the voltage drop. In applications not requiring the current sensing circuit breaker, tie the SENSE pin to the  $V_{CC}$  pin.

### Configuring the PG Pin Output

The LTC2921 and LTC2922 each include a power good indicator, the PG pin. During the turn-on sequence, and upon detection of errors, a strong FET pulls PG to ground with >10mA of current. When all supplies have satisfied their monitor and overvoltage thresholds, the circuit breaker has not tripped, the GATE pin has reached its peak, and the remote sense switches have turned on, a 4 $\mu$ A current source from  $V_{PUMP}$  pulls up PG.

Configure PG as a logic signal by adding an external pull-up resistor to a voltage source. For example, create a negative-logic system reset signal by adding an external pull-up resistor to the load side of a supply voltage, as in Figure 8. Calculate the minimum pull-up resistor value that meets the output low voltage specification for  $V_{PG(OL)}$ :

$$R_{PG(MIN)} = \frac{V_{LO(MAX)} - 0.4V}{5mA} \quad (10)$$

Do not pull PG above the GATE pin's fully ramped voltage. An internal clamp limits the PG voltage to  $\leq 12.2V$  relative to ground. In applications that do not require the PG output, leave the pin unconnected.

The PG output can also be used as the gate drive for external N-channel MOSFETs, as in Figure 9. The delay between the GATE ramp and the PG activation makes a supply sequencer, useful when two supplies (or two groups of supplies) need to be ramped one after another. Choose the FETs and design the ramp rate in the same way as for the GATE pin. Refer to Equations 5 and 6, substituting 4 $\mu$ A for 10 $\mu$ A, to choose capacitor  $C_{PG}$ .

### Integrated Switches for Remote Sensing

A significant feature of the LTC2921/LTC2922 series is a set of remote sense switches that allow for compensation of voltage drops in the load path. Switch activation occurs in the turn-on sequence after the GATE

## APPLICATIONS INFORMATION



Figure 8. PG Pin as Logic Output



Figure 9. PG Pin as Sequenced N-Channel Gate Driver

pin has fully ramped up. The switches are N-channel MOSFETs whose gates are ramped from ground to  $V_{PUMP}$  at a nominal rate of 8V/ms. The PG pin is activated upon completion of the TIMER delay cycle that follows GATE ramp-up and remote sense switch activation. When conditions indicate a supply disconnect, the switches shut off in less than 10 $\mu$ s.

Figure 10 shows an example of how to connect a switch to remote sense the load voltage. Although only one remote sense switch is referred to in this section, the calculations and comments apply to all.

Before the activation of Q1 and the internal switch, resistor  $R_{X1}$  provides a direct path between the DC/DC converter's output voltage and its feedback network ( $R_{Y1}$  and  $R_{Z1}$ ). Once Q1 activates, the supply energizes the load. When the internal switch turns on, it provides a remote sense path between the load voltage and the converter's feedback network.



Figure 10. Automatic Remote Sense Switching Connection

To choose a value for resistor  $R_{X1}$ , consider the remote sense switch connection equivalent network in Figure 11. Resistor  $R_{Q1(ON)}$  represents the on-resistance of Q1, and resistor  $R_{FB1(ON)}$  represents the on-resistance of the internal switch.



Figure 11. Remote Sense Switch Connection Equivalent Network

To allow the load voltage to dominate the feedback to the converter when the internal switch is closed, make  $R_{X1} \gg R_{FB1(ON)}$ . To set the converter feedback ratio accurately with  $R_{Y1}$  and  $R_{Z1}$ , make both  $R_{X1}$  and  $R_{FB1(ON)}$  much less than  $(R_{Y1} + R_{Z1})$ . To ensure that most of the load current flows through the external N-channel FET, choose  $(R_{X1} + R_{FB1(ON)}) \gg R_{Q1(ON)}$ . Summarized, these requirements amount to:

$$R_{Q1(ON)}, R_{FB1(ON)} \ll R_{X1} \ll (R_{Y1} + R_{Z1}) \quad (11)$$

Approach the selection of  $R_{X1}$  in the following way: design the DC/DC converter feedback based on the resistive divider formed by  $R_{Y1}$  and  $R_{Z1}$  with  $V_{S1}$  at the desired supply voltage value. When the resistor values satisfy Equation 11, Equations 12 through 15 are valid.

## APPLICATIONS INFORMATION

Before Q1 closes to connect the load, the actual supply voltage relative to  $V_{S1}$  is given by Equation 12.

$$\Delta V_{SRC1} = V_{SRC1} - V_{S1} = V_{S1} \cdot \left( \frac{R_{X1}}{R_{X1} + R_{Y1} + R_{Z1}} \right) \quad (12)$$

After both Q1 and the internal remote sense switch have closed, the load voltage relative to  $V_{S1}$  is given by Equation 13.

$$\Delta V_{L1} = V_{L1} - V_{S1} = -I_{L1} \cdot R_{Q1(ON)} \cdot \left( \frac{R_{FB1(ON)}}{R_{X1}} \right) \quad (13)$$

A small part of the load current will flow through the remote sense switch. Use Equation 14 to calculate the current, and do not exceed the switch current Absolute Maximum Rating when choosing the value of  $R_{X1}$ .

$$I_{DS1} = I_{L1} \cdot \left( \frac{R_{Q1(ON)}}{R_{X1}} \right) \quad (14)$$

In addition, once the remote sensing is active, the supply voltage  $V_{SRC1}$  will rise by approximately the drop across the external FET. The effect on the monitor resistive divider design has already been accounted for in the previous section, Setting the Supply Monitor Levels.

$$\begin{aligned} V_{SRC1} &= V_{S1} + I_{L1} \cdot R_{Q1(ON)} \cdot \left( 1 - \frac{R_{FB1(ON)}}{R_{X1}} \right) \\ &\approx V_{S1} + V_{Q1(ON)} \end{aligned} \quad (15)$$

The terminals of each switch are interchangeable; choose the connections to optimize the board layout. Ground all unused switch pins.

### Design Example

Consider the design of a three-supply monitoring system, as shown in Figure 12, with specifications as listed in Table 1.

**Table 1. Design Example Electrical Specifications**

Supply Specifications		
5V $\pm$ 7.5%	$V_{SRC0(MAX)} = 5.375V$ $V_{SRC0(MIN)} = 4.625V$	$I_{L0} = 0.8A$ (max)
3.3V $\pm$ 7.5%	$V_{SRC1(MAX)} = 3.5475V$ $V_{SRC1(MIN)} = 3.0525V$	$I_{L1} = 1.6A$ (max)
2.5V $\pm$ 7.5%	$V_{SRC2(MAX)} = 2.6875V$ $V_{SRC2(MIN)} = 2.3125V$	$I_{L2} = 0.4A$ (max)
External N-channel FET Drain-Source Voltage Specification		
5V Supply	$V_{Q0(ON)(MAX)} < 250mV$	
3.3V Supply	$V_{Q1(ON)(MAX)} < 250mV$	
2.5V Supply	$V_{Q2(ON)(MAX)} < 150mV$	
Timing Specification		
TIMER Delay	$t_{DLY} = 150ms$ (nom)	
GATE Ramp Time	$t_{RAMP} = 500ms$ (nom)	
Bias Current Specification		
Monitor Resistive Divider Current	$I_{A1} = 10\mu A$ (nom) $I_{A2} = 10\mu A$ (nom)	
Other Requirements		
<ul style="list-style-type: none"> <li>Remote Sense all 3 Load Voltages</li> <li>Tight Monitoring Levels</li> <li>Use Circuit Breaker Function</li> <li>DC/DC Converter Feedback Resistive Divider <math>&gt; 100k\Omega</math></li> </ul>		

The LTC2921 suits this application because the largest supply in the system is 5V, and only three remote sense switches are required.

Start with the design of the resistive dividers that set the monitor levels. As the largest supply voltage, the 5V supply must be connected to the  $V_{CC}$  pin; an internal resistive divider sets that monitor level. Consult the Electrical Characteristics table to confirm that  $V_{SRC0(MIN)} > V_{CC(MON)(MAX)}$  and  $V_{SRC0(MAX)} < V_{CC(OV)(MIN)}$ .

The bias current in the lower resistor for the 3.3V supply's dividers yields a standard 1% value of  $R_{A1} = 49.9k$ :

$$R_{A1} = \frac{0.500V}{10\mu A} = 50k \approx 49.9k$$

## APPLICATIONS INFORMATION



Figure 12. Design Example of a Three-Supply Tracker and Monitor (5V, 3.3V, 2.5V)

Selecting  $R_{B1} = 243k$  satisfies the range restrictions below:

$$R_{B1(MAX)} = 49.9k \cdot \left( \frac{1 - 0.01}{1 + 0.01} \right) \cdot$$

$$\left( \frac{3.0525V - 0.505V}{0.505V + 0.1\mu A \cdot 49.9k} \right) = 244.3k$$

$$R_{B1(MIN)} = 49.9k \cdot \left( \frac{1 + 0.01}{1 - 0.01} \right) \cdot$$

$$\left( \frac{3.5475V + 0.250V - 0.665V}{0.665V - 0.1\mu A \cdot 49.9k} \right) = 241.6k$$

$$R_{A2} = \frac{0.500V}{10\mu A} = 50k \approx 49.9k$$

$$R_{B2(MAX)} = 49.9k \cdot \left( \frac{1 - 0.01}{1 + 0.01} \right) \cdot$$

$$\left( \frac{2.3125V - 0.505V}{0.505V + 0.1\mu A \cdot 49.9k} \right) = 173.3k$$

$$R_{B2(MIN)} = 49.9k \cdot \left( \frac{1 + 0.01}{1 - 0.01} \right) \cdot$$

$$\left( \frac{2.6875V + 0.150V - 0.665V}{0.665V - 0.1\mu A \cdot 49.9k} \right) = 167.6k$$

Similar calculations for the 2.5V supply yield suitable standard 1% values of  $R_{A2} = 49.9k$  and  $R_{B2} = 169k$ .

Tie the unused V3 and V4 monitor pins to V2 for proper operation.



## APPLICATIONS INFORMATION

Next, consider the supply ramping N-channel MOSFETs Q0, Q1 and Q2. Transistor Q0 will have >4.5V of gate-source voltage, even at maximum supply voltage (5.375V) and minimum GATE pin voltage (10V). Considering the voltages, temperatures, and currents involved, the maximum on-resistance ( $R_{Q(ON)(MAX)}$ ) of the Vishay Siliconix Si2316DS is about 150m $\Omega$ . Switches Q1 and Q2 will see even higher gate-source voltages, implying even smaller  $R_{Q(ON)(MAX)}$  values. Table 2 summarizes the calculated  $V_{Q(ON)(MAX)}$  voltages. Include the additional 50mV drop across  $R_{SENSE}$  when budgeting for the  $V_{CC}$  supply path.

**Table 2. External MOSFET Drain-Source Voltage Drops**

Supply Voltage	External MOSFET	$R_{Q(ON)}$ Max	$I_L$ Max	$V_{Q(ON)}$ Max
5V	Q0	~150m $\Omega$	0.8A	120mV (+50mV = 170mV)
3.3V	Q1	<150m $\Omega$	1.6A	<240mV
2.5V	Q2	<150m $\Omega$	0.4A	<60mV

The  $\pm 20V$  absolute maximum gate-source voltage rating of the Si2316DS easily accommodates this design.

Next, calculate the necessary capacitance on the GATE pin to realize the desired ramp rate. Use the nominal value of  $V_{GATE}$  from the Electrical Specification, and choose a standard value.

$$C_{GATE} = \frac{10\mu A \cdot 500ms}{10.8V} = 0.463\mu F \approx 0.47\mu F$$

Include drain bypass capacitors of 0.1 $\mu F$  and series gate resistors of 10 $\Omega$  on each external power FET to damp turn-on oscillations.

Find the capacitance at the TIMER pin required to set the delays in the power-on sequence:

$$C_{TIMER} = \frac{2\mu A}{1.2V} \cdot 150ms = 0.25\mu F \approx 0.22\mu F$$

The application requires the use of the circuit breaker function on the  $V_{CC}$  supply. First, find the upper limit on the sense resistor value:

$$R_{SENSE} \leq \frac{45mV}{0.8A} = 53.25m\Omega$$

Select a precision power sense resistor, such as the Vishay Dale WSL1206 series. They can be specified to 1%, and exhibit <1% variation over the LTC2921/LTC2922 operating range; choose  $R_{SENSE} = 50m\Omega$ . Including tolerances, the circuit breaker trip current threshold variation will be:

$$I_{TRIP(MIN)} = \frac{45mV}{51m\Omega} = 0.88A$$

$$I_{TRIP(MAX)} = \frac{55mV}{49m\Omega} = 1.12A$$

The PG pin is configured as a 2.5V negative-logic reset signal for the microcontroller. The minimum pull-up resistance for proper operation is:

$$R_{PG(MIN)} = \frac{2.6875V - 0.4V}{5mA} \approx 460\Omega$$

Figure 13 shows  $R_{PG} = 4.7k$ . The value is somewhat arbitrarily chosen, but it does limit the pull-down current to <500 $\mu A$ . Trade off lower pull-down currents against faster pull-up edge rates in other applications.

Recall that proper operation of the remote load sensing function requires:

$$R_{Q(ON)}, R_{FB(ON)} \ll R_X \ll (R_Y + R_Z)$$

In this example, the operating conditions and the Si2316DS give  $R_{Q(ON)(MAX)} = 150m\Omega$ , the Electrical Characteristics table guarantees  $R_{FB(ON)} < 10\Omega$ , and the example design specification requires that  $(R_Y + R_Z) < 100k$ . Selecting  $R_{X0} = R_{X1} = R_{X2} = 100\Omega$  satisfies the inequality.

Before the loads are connected to the supplies, the voltage error due to the  $R_X$  resistors will be <0.1% for all three supplies:

$$\Delta V_{SRC} = V_{SRC} \cdot \left( \frac{100\Omega}{100k} \right) = \frac{V_{SRC}}{1000} = 0.1\% \text{ of } V_{SRC}$$

After the remote sense switches close, the load voltage errors due to  $R_X$  at maximum loads will be:

## APPLICATIONS INFORMATION

$$\Delta V_{L0} = -0.8A \cdot 150m\Omega \cdot \left(\frac{10\Omega}{100\Omega}\right) = -12mV$$

$$= -0.24\% \text{ of } 5V$$

$$\Delta V_{L1} = -1.6A \cdot 150m\Omega \cdot \left(\frac{10\Omega}{100\Omega}\right) = -24mV$$

$$= -0.73\% \text{ of } 3.3V$$

$$\Delta V_{L2} = -0.4A \cdot 150m\Omega \cdot \left(\frac{10\Omega}{100\Omega}\right) = -6mV$$

$$= -0.24\% \text{ of } 2.5V$$

$$I_{DS1} = 0.8A \cdot \left(\frac{150m\Omega}{100\Omega}\right) = 1.2mA$$

$$I_{DS2} = 1.6A \cdot \left(\frac{150m\Omega}{100\Omega}\right) = 2.4mA$$

$$I_{DS3} = 0.4A \cdot \left(\frac{150m\Omega}{100\Omega}\right) = 0.6mA$$

The pull-down transistor Q5 on the V1 pin is a circuit breaker reset mechanism. Choose the transistor to pull down  $V_{V1}$  below the reset threshold under worst-case conditions, and choose a gate-grounding resistor based on speed and current considerations. The Vishay Siliconix Si1012R and a 100k resistor proved sufficient for this design. Finally, bypass the  $V_{CC}$  pin with a 10 $\mu$ F capacitor.

Confirm that the currents through the remote sense switches are less than the Absolute Maximum Ratings:

## TYPICAL APPLICATIONS



# PACKAGE DESCRIPTION

## F Package 20-Lead Plastic TSSOP (4.4mm) (Reference LTC DWG # 05-08-1650)



- NOTE:
1. CONTROLLING DIMENSION: MILLIMETERS
  2. DIMENSIONS ARE IN  $\frac{\text{MILLIMETERS}}{\text{(INCHES)}}$
  3. DRAWING NOT TO SCALE
- \*DIMENSIONS DO NOT INCLUDE MOLD FLASH. MOLD FLASH SHALL NOT EXCEED .152mm (.006") PER SIDE
- \*\*DIMENSIONS DO NOT INCLUDE INTERLEAD FLASH. INTERLEAD FLASH SHALL NOT EXCEED .254mm (.010") PER SIDE



## GN Package 16-Lead Plastic SSOP (Narrow .150 Inch) (Reference LTC DWG # 05-08-1641)



- NOTE:
1. CONTROLLING DIMENSION: INCHES
  2. DIMENSIONS ARE IN  $\frac{\text{INCHES}}{\text{(MILLIMETERS)}}$
  3. DRAWING NOT TO SCALE
- \*DIMENSION DOES NOT INCLUDE MOLD FLASH. MOLD FLASH SHALL NOT EXCEED 0.006" (0.152mm) PER SIDE
- \*\*DIMENSION DOES NOT INCLUDE INTERLEAD FLASH. INTERLEAD FLASH SHALL NOT EXCEED 0.010" (0.254mm) PER SIDE



# LTC2921/LTC2922 Series

## TYPICAL APPLICATION

Early-Late Supply Sequencer with Early Supplies LED Indicator



## RELATED PARTS

PART NUMBER	DESCRIPTION	COMMENTS
LTC2900	Programmable Quad Supply Monitor	Adjustable RESET Timer, 10-Lead MSOP Package
LTC2901	Programmable Quad Supply Monitor with Watchdog	Adjustable RESET Timer and Watchdog Timer, Individual Comparator Outputs
LTC2902	Programmable Quad Supply Monitor	Adjustable RESET Timer, Selectable Tolerance, RESET Disable for Margining.
LTC4211	Hot Swap Controller with Multifunction Current Control	Operates from 2.5V to 16.5V, 10-Lead MSOP Package
LTC4230	Triple Hot Swap Controller with Multifunction Current Control	Operates from 1.7V to 16.5V, Supply Tracking

29212fa



Компания «ЭлектроПласт» предлагает заключение долгосрочных отношений при поставках импортных электронных компонентов на взаимовыгодных условиях!

Наши преимущества:

- Оперативные поставки широкого спектра электронных компонентов отечественного и импортного производства напрямую от производителей и с крупнейших мировых складов;
- Поставка более 17-ти миллионов наименований электронных компонентов;
- Поставка сложных, дефицитных, либо снятых с производства позиций;
- Оперативные сроки поставки под заказ (от 5 рабочих дней);
- Экспресс доставка в любую точку России;
- Техническая поддержка проекта, помощь в подборе аналогов, поставка прототипов;
- Система менеджмента качества сертифицирована по Международному стандарту ISO 9001;
- Лицензия ФСБ на осуществление работ с использованием сведений, составляющих государственную тайну;
- Поставка специализированных компонентов (Xilinx, Altera, Analog Devices, Intersil, Interpoint, Microsemi, Aeroflex, Peregrine, Syfer, Eurofarad, Texas Instrument, Miteq, Cobham, E2V, MA-COM, Hittite, Mini-Circuits, General Dynamics и др.);

Помимо этого, одним из направлений компании «ЭлектроПласт» является направление «Источники питания». Мы предлагаем Вам помощь Конструкторского отдела:

- Подбор оптимального решения, техническое обоснование при выборе компонента;
- Подбор аналогов;
- Консультации по применению компонента;
- Поставка образцов и прототипов;
- Техническая поддержка проекта;
- Защита от снятия компонента с производства.



#### Как с нами связаться

**Телефон:** 8 (812) 309 58 32 (многоканальный)

**Факс:** 8 (812) 320-02-42

**Электронная почта:** [org@eplast1.ru](mailto:org@eplast1.ru)

**Адрес:** 198099, г. Санкт-Петербург, ул. Калинина, дом 2, корпус 4, литера А.