

# IB IL IMPULSE-IN ...

**Inline Modular position detection terminal,  
input for magnetostrictive position transducers  
with START/STOP interface**

## AUTOMATION

Data sheet  
6754\_en\_05

© PHOENIX CONTACT - 2010-07-23

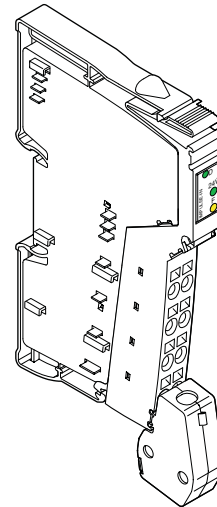

## 1 Description

The terminal is designed for use within an Inline station and is used to evaluate magnetostrictive position transducers with START/STOP interface (digital impulse interface).

The time between a request pulse and its reply pulse is directly proportional to the position of the position encoder on the measurement path. Impulses are transmitted without interference via a differential driver according to RS-422.

The terminal has a channel in the local bus protocol, which is requested and configured via two process data words.

### 1.1 Features

- 24 V DC encoder supply
- Diagnostic and status indicators

### 1.2 Applications

Encoders with START/STOP interface can be connected.



This data sheet is only valid in association with the IL SYS INST UM E user manual.



Make sure you always use the latest documentation.  
This can be downloaded at [www.phoenixcontact.net/catalog](http://www.phoenixcontact.net/catalog).



This data sheet is valid for the products listed on the following page:

## 2 Ordering data

### Inline terminals

Description	Type	Order No.	Pcs./Pkt.
Inline Modular position detection terminal, input for magnetostrictive position transducers with START/STOP interface, without accessories, transmission speed of 500 kbps	IB IL IMPULSE-IN	2819231	1
Inline Modular position detection terminal, input for magnetostrictive position transducers with START/STOP interface, complete with accessories (connectors and labeling fields), transmission speed of 500 kbps	IB IL IMPULSE-IN-PAC	2861768	1
Inline Modular position detection terminal, input for magnetostrictive position transducers with START/STOP interface, without accessories, transmission speed of 2 Mbps	IB IL IMPULSE-IN-2MBD	2819817	1
Inline Modular position detection terminal, input for magnetostrictive position transducers with START/STOP interface, complete with accessories (connectors and labeling fields), transmission speed of 2 Mbps	IB IL IMPULSE-IN-2MBD-PAC	2819804	1



The connector listed below is needed for the complete fitting of the IB IL IMPULSE-IN and IB IL IMPULSE-IN-2MBD terminals.

### Accessories

Description	Type	Order No.	Pcs./Pkt.
Inline shield connector for analog Inline terminals	IB IL SCN-6 SHIELD	2726353	5

### Documentation

Description	Type	Order No.	Pcs./Pkt.
"Automation terminals of the Inline product range" user manual	IL SYS INST UM E	2698737	1

## 3 Technical data

### General data

Housing dimensions (width x height x depth)	12.2 mm x 136 mm x 72 mm (with connector)
Weight (without connectors)	50 g (without connector), 71 g (with connector)
Operating mode	Process data mode with 2 words
Ambient temperatures (operation)	-25°C ... +55°C
Ambient temperature (storage/transport)	-25°C ... +85°C
Permissible humidity (operation/storage/transport)	10% ... 95% according to DIN EN 61131-2
Permissible air pressure (operation/storage/transport)	70 kPa ... 106 kPa (up to 3000 m above sea level)
Degree of protection	IP20
Protection class	III, IEC 61140
Connection data for Inline connectors	
Connection method	Spring-cage terminals
Conductor cross-section	0.08 mm <sup>2</sup> ... 1.5 mm <sup>2</sup> (solid or stranded), 28 - 16 AWG

### Interface

Local bus	Inline data jumper
START/STOP interface	Comprising a differential input and a differential output according to RS-422

### Transmission speed

IB IL IMPULSE-IN, IB IL IMPULSE-IN-PAC	500 kbps
IB IL IMPULSE-IN-2MBD, IB IL IMPULSE-IN-2MBD-PAC	2 Mbps

Power consumption	500 kbps	2 Mbps
Communications power $U_L$	7.5 V	7.5 V
Current consumption from $U_L$	70 mA, maximum	100 mA, maximum
Power consumption from $U_L$	0.525 W	0.750 W
Main supply voltage $U_M$	24 V DC, typical	24 V DC, typical
Current consumption from $U_M$	150 mA, typical (with connected encoder)	150 mA, typical (with connected encoder)

### Supply of the module electronics and I/O through bus coupler/power terminal

Connection method	Through potential routing
-------------------	---------------------------

### Magnetostrictive encoder

Interface	START/STOP interface
Signal voltage level	Differential signal (signal – inverted signal) $\pm 0.5$ V, minimum; $\pm 6.0$ V, maximum
Common mode range: signal – ground	-10 V ... +13.2 V
Length measuring range	> 0 mm to 3850 mm
Resolution	5 $\mu$ m
Ultrasonic speed (gradient)	2500.00 m/s ... 2999.99 m/s (Firmware 1.22 or later) 2750 m/s ... 2898 m/s (Firmware 1.22 or later)

### Encoder supply

Voltage range	19.2 V ... 30.0 V (from $U_M$ )
Short-circuit protection	Electronic and thermal
Current carrying capacity	250 mA, maximum



The status of the encoder supply is indicated by the green 24 V LED. If the internal voltage for the encoder electronics fails or is overloaded, an I/O error is generated. This error is indicated by the diagnostic LED flashing at 2 Hz and transmitted to the higher-level control system.

### Error messages to the higher-level control or computer system

Failure or overload of the encoder supply	Yes, I/O error message sent to the controller board
---	---

### Limitation of simultaneity, derating

No derating

### Electrical isolation/isolation of the voltage areas

Electrical isolation of the logic level from the I/O area is ensured by the optocoupler.

### Common potentials

The 24 V main voltage, 24 V segment voltage, and GND have the same potential. FE is a separate potential area.

### Separate potentials

Test distance	Test voltage
7.5 V supply (bus logic)/ I/O	500 V AC, 50 Hz, 1 min.
7.5 V supply (bus logic)/functional earth ground	500 V AC, 50 Hz, 1 min.
24 V supply (I/O)/functional earth ground	500 V AC, 50 Hz, 1 min.

**Conformance with EMC directive 2004/108/EC****Noise immunity test according to EN 61000-6-2**

Electrostatic discharge (ESD)	EN 61000-4-2 (IEC 61000-4-2)	Criterion B: Temporary impairment of operating behavior that is corrected by the device itself.	6 kV contact discharge 8 kV air discharge
Electromagnetic HF field	EN 61000-4-3 (IEC 61000-4-3)	Criterion A: Normal operating behavior within the specified limits.	Field strength: 10 V/m
Fast transients (burst)	EN 61000-4-4 (IEC 61000-4-4)	Criterion B: Temporary impairment of operating behavior that is corrected by the device itself.	Signal: 2 kV Supply: 2 kV
Surge current load (surge)	EN 61000-4-5 (IEC 61000-4-5)	Criterion B: Temporary impairment of operating behavior that is corrected by the device itself.	Signal: Up to $\pm 1$ kV asymmetrical Supply: $\pm 0.5$ kV symmetrical, $\pm 0.5$ kV asymmetrical
Conducted interference	EN 61000-4-6 (IEC 61000-4-6)	Criterion A: Normal operating behavior within the specified limits.	Test voltage 10 V

**Noise emission test according to EN 61000-6-4**

Noise emission of housing	EN 55011 (corresponds to CISPR11)	Class A: Industrial application, without special installation measures.	Class A
---------------------------	--------------------------------------	--	---------

**Approvals**

For the latest approvals, please visit [www.phoenixcontact.net/catalog](http://www.phoenixcontact.net/catalog).

## 4 Basic circuit diagram

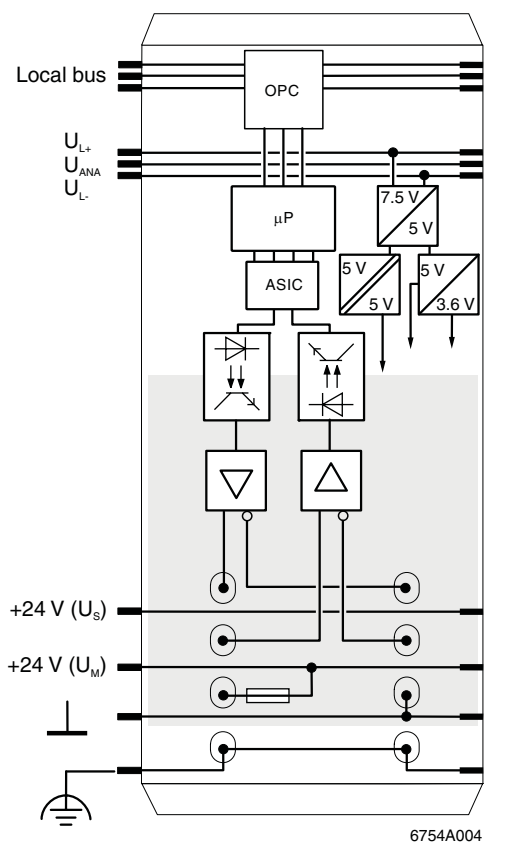

### Key:











-  Protocol chip (bus logic including voltage conditioning)
-  Microprocessor
-  ASIC chip
-  Power supply unit without electrical isolation
-  Power supply unit with electrical isolation
-  Optocoupler
-  RS-422 interface
-  Terminal point
-  Fuse
-  Ground (GND)
-  Functional earth ground
-  Electrically isolated area

Figure 1 Internal wiring of the terminal points

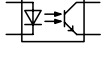
## 5 Local diagnostic/status indicators and terminal point assignment

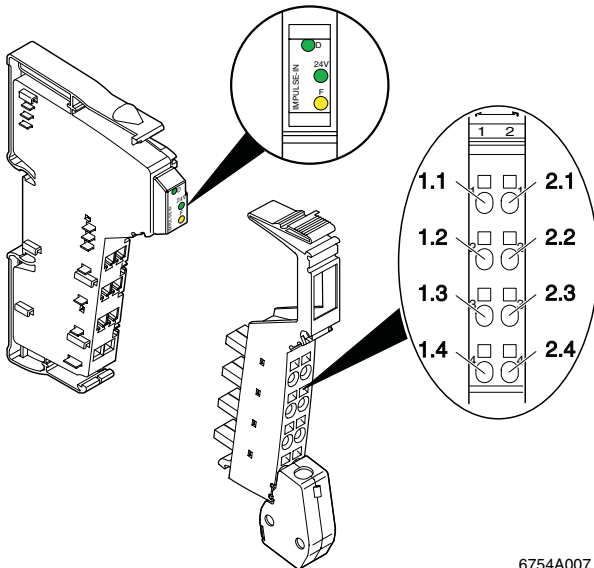

6754A007

Figure 2 Local diagnostic and status indicators

### 5.1 Local diagnostic and status indicators

Des.	Color	Meaning
D	Green LED	Diagnostics (bus and logic supply)
24V	Green LED	24 V encoder supply
		ON: 24 V encoder supply present OFF: 24 V encoder supply not present or short circuit
F	Yellow LED	Measurement
		ON: Invalid measurement
		OFF: Valid measurement

### 5.2 Function identification

Orange

2 Mbps: White stripe in the vicinity of the D LED

### 5.3 Terminal point assignment

Terminal point	Signal	Assignment
1.1	INIT	INIT output
2.1	/INIT	Inverted INIT output
1.2	START-STOP	START/STOP input
2.2	/START-STOP	Inverted START/STOP input
1.3	24 V	Encoder supply (250 mA, maximum)
2.3	GND	Ground
1.4, 2.4	Shield	Encoder cable shield

## 6 Connection example

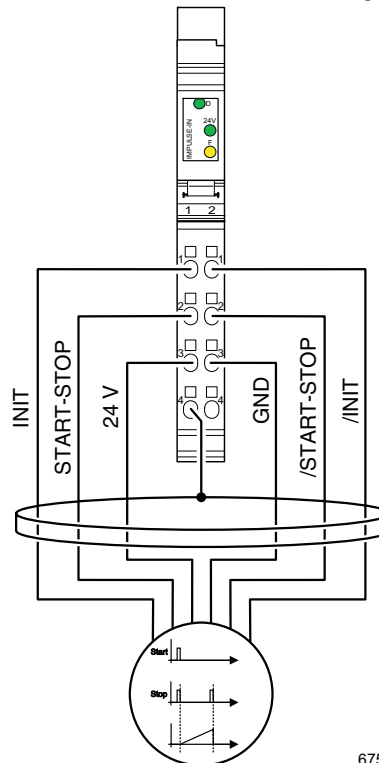

6754C005

Figure 3 Typical connection

Legend:



Impulse encoder

## 7 Connection notes



Encoders should always be connected using **shielded** twisted pair cables. Unshielded cables may lead to erroneous results in environments with heavy noise. On the terminal side, the shield is capacitively connected to functional earth ground (FE) via the shield connector. On the encoder side, the shield must be connected with the grounded encoder housing.

If the encoder does not have a shield connection, the shield can also be directly connected in the control cabinet to functional earth ground via an additional shield connection clamp.



For additional information about shielding and connecting the shielded cables, please refer to the IL SYS INST UM E user manual.



Please also observe the manufacturer's installation instructions for the position encoder.

## 8 Functions

The terminal is used to evaluate magnetostrictive position transducers with START/STOP interface.

These systems operate absolutely in the measuring range from > 0 mm to 3850 mm with a resolution of 5 µm. An external power supply unit for the position encoder is not required, as power is provided by the terminal.

The data width in the bus system is 32 bits. The IN register has seven bits for status indicators and messages and 25 bits for actual position values (see "IN process data" on page 8).

The OUT register has seven bits for control codes, three bits for the encoder length, and 20 bits for the ultrasonic speed (see "OUT process data" on page 9).

### 8.1 Error messages

The terminal has monitoring mechanisms, which trigger in the event of the following errors and generate an I/O error message:

- I/O error (monitoring of the position encoder power supply)  
If the encoder supply fails or is overloaded, an I/O error is triggered and a corresponding message code is generated.

### 8.2 Actual value acquisition

On each firmware cycle (measuring cycle) the position of the position sensor is acquired. The firmware cycle depends on the set encoder length.

For actual value acquisition, an impulse (START) is sent to a position transducer, which leads to a reply impulse (STOP) through reflection at the magnetic field of the position sensor. The terminal measures the time that elapses until the reply impulse is returned.

In the terminal, the return path is calculated by multiplying with the propagation rate of the impulse in the position transducer, and stored in the process data.

## 9 Programming and configuration data

### 9.1 Local bus (INTERBUS)

ID code	5F <sub>hex</sub> (95 <sub>dec</sub> )
Length code	02 <sub>hex</sub> (133 <sub>dec</sub> )
Process data channel	32 bits
Input address area	2 words
Output address area	2 words
Parameter channel (PCP)	0 bytes
Register length (bus)	2 words

### 9.2 Other bus systems



For the configuration data of other bus systems, please refer to the corresponding electronic device data sheet (e.g., GSD, EDS).

## 10 Process data

### 10.1 IN process data

(Word.bit) view	Word	Word 0															
	Bit	15	14	13	12	11	10	9	8	7	6	5	4	3	2	1	0
(Byte.bit) view	Byte	Byte 0								Byte 1							
	Bit	7	6	5	4	3	2	1	0	7	6	5	4	3	2	1	0
IN[0]	Assignment	Status								Actual position value (bits 16 to 24)							
(Word.bit) view	Word	Word 1															
	Bit	15	14	13	12	11	10	9	8	7	6	5	4	3	2	1	0
(Byte.bit) view	Byte	Byte 2								Byte 3							
	Bit	7	6	5	4	3	2	1	0	7	6	5	4	3	2	1	0
IN[0]	Assignment	Actual position value (bits 0 to 15)															

#### Status

IN[0] Bit 15 to Bit 9		Description	Position actual value
bin	hex		
000 0000	00	<b>Offline:</b> The module is in the idle state. The configuration data is checked by sending the "Read position" command. If this is valid, the module changes to the "operation" state.	Invalid
000 0001	01	<b>Operation:</b> If bit 9 = TRUE, the measured value (the position) of the position sensor is valid, i.e., the configuration data is valid and valid position values have been read by the encoder.	Valid
X1X XXX0	XX	Acknowledgment for the "Acknowledge error" control code. Once the control code at "Read position" has been modified, the terminal changes to the "Read position" state (if the error has been removed) or returns to one of the error states.	Invalid
100 0010	42	<b>Error:</b> Encoder supply not present or short circuit.	Invalid
100 0100	44	<b>Error:</b> Encoder error After sending the START impulse, no STOP impulse was received by the encoder within the maximum measuring time (dependent on the configured encoder length, see <b>OUT[0] Bit4 ... Bit6</b> ).	Invalid
100 1000	48	<b>Error:</b> Invalid configuration data The configuration data is outside the limit values.	Invalid
101 0000	50	<b>Error:</b> Invalid control code An unknown or invalid control code was transferred.	Invalid
101 1000	58	<b>Error:</b> Cycle time too short No reliable position measurement is possible because the INTERBUS cycle time is too short.	Invalid

#### Position actual value

Absolute actual value of the current position with a resolution of 5 µm.

Example:

$$12.05 \text{ cm} = 120500$$

$$120500 \text{ µm} / 5 \text{ µm} = 24100 = 5E24_{\text{hex}}$$



### 10.2 OUT process data

The OUT process data is evaluated as soon as the control code is mirrored in the IN process data.



The OUT process data specifies the output values in each bus cycle. The configuration data must be complete. Without complete configuration data, the terminal will not change to the ready state.

(Word.bit) view	Word	Word 0																	
	Bit	15	14	13	12	11	10	9	8	7	6	5	4	3	2	1	0		
(Byte.bit) view	Byte	Byte 0								Byte 1									
	Bit	7	6	5	4	3	2	1	0	7	6	5	4	3	2	1	0		
OUT[0]	Assignment	Control code								0	0	Encoder length				Ultrasonic speed (bits 19 to 16)			

(Word.bit) view	Word	Word 0															
	Bit	15	14	13	12	11	10	9	8	7	6	5	4	3	2	1	0
(Byte.bit) view	Byte	Byte 0								Byte 1							
	Bit	7	6	5	4	3	2	1	0	7	6	5	4	3	2	1	0
OUT[1]	Assignment	Ultrasonic speed (bits 15 to 0)															



**NOTE: Misinterpretation of values when data is not consistent**  
Ensure data consistency of two words to prevent the possibility of misinterpreting the values.

#### Control code

The control code is used to select terminal operating states. When the terminal has detected the control code, it is mirrored in the status (see Section "Status" ).

OUT[0] Bits 15 to 9		Control code
bin	hex	
000 0000	00	No action (ignored)
000 0001	01	<b>Read position:</b> On the transition from the "Offline" state to the "Operation" state, the configuration data is checked and the terminal is configured. When position acquisition is successful, the module changes to the "Operation" state.
000 0010	02	<b>Switch "Offline":</b> The terminal changes from the "Operation" state to the "Offline" state; the configuration is reset.
010 0001	21	<b>Acknowledge error:</b> On the transition from the "Error" state to the "Operation" state, the configuration is maintained.

The terminal supports various error codes, which are generally reported as encoder errors.

The causes are:

- No echo  
(Encoder not connected correctly; position encoder faulty; position encoder too far from position transducer; position encoder has exited the valid range of the position transducer)
- Incorrect echo  
(Position transducer itself is strongly accelerated; strongly bundled magnetic field affecting the position transducer)

In the event of an encoder error that is to be removed or ignored, the encoder error can be acknowledged by the control code 010 0001<sub>bin</sub>. After an acknowledgment, normal operation must be set (control code 000 0001<sub>bin</sub>).

If the error remains after the acknowledgment has been removed, a new error is indicated (status 1xx xxxx<sub>bin</sub>).

#### "0" (unused):

These bits should **not** be set (unknown configuration).

### Encoder length

In order to optimize the time required for the acquisition of a position, the terminal should know the encoder length (position transducer length). This is divided into increments of 0.5 m and **rounded up** if required, i.e., if the encoder length is between two values, the next highest length should always be specified.

OUT[0] Bit 4 to Bit 6		Encoder length
bin	hex	
0000	0	0.5 m
0001	1	1.0 m
0010	2	1.5 m
0011	3	2.0 m
0100	4	2.5 m
0101	5	3.0 m
0110	6	3.5 m
0111	7	4.0 m

Encoder length	Limit values		
	dec	hex	bin
Minimum	0.5 m	0	0000
Maximum	4.0 m	7	0111

If the values of the encoder length are outside the limit value range, the terminal outputs the message code "Invalid configuration data" (1000100<sub>bin</sub>).



**NOTE: Inaccurate measurement owing to incorrect encoder length**

If the specified encoder length (position transducer length) is too short, measurements will be inaccurate.

### Ultrasonic speed

During configuration, the ultrasonic speed of the pulse in the position transducer (indicated on the rating plate of the position transducer) must be sent to the terminal, so that the terminal can correctly calculate the position of the position transducer.

Ultrasonic speed	Limit values		
	dec [m/s]	hex	bin
<b>Firmware 2.01 or later</b>			
Minimum	2500.00	50000	0101 0000 0000 0000 0000
Maximum	2999.99	99999	1001 1001 1001 1001 1001
<b>Firmware 1.21 or earlier</b>			
Minimum	2750	75000	0111 0101 0000 0000 0000
Maximum	2898	89800	1000 1001 1000 0000 0000

If the values of the ultrasonic speed are outside the limit value range, the terminal outputs the message code "Invalid configuration data" (1000100<sub>bin</sub>).

Since the terminal internally adds an offset of 2000 m/s, the value specified on the rating plate is sent to the terminal as a hexadecimal value without the highest integer position.

Example:

Ultrasonic speed in the position transducer  
= 2835.45 m/s

Value sent to terminal:  
835.45 = 83545<sub>hex</sub>

### 10.3 "Read Firmware Version and Sub ID" special function

The terminal has a special function, which can be used to read its firmware version and sub ID. The sub ID can be used to distinguish between other Inline terminals with the same ID code. The terminal has the sub ID "F<sub>hex</sub>".



The firmware version and sub ID can only be requested in the "Offline" state. During operation, this control command generates an error message.

Word	OUT[0]															
Bit	15	14	13	12	11	10	9	8	7	6	5	4	3	2	1	0
Bin	0	0	1	1	1	1	0	0	0	0	0	0	0	0	0	0
Hex	3				C				0				0			
Word	OUT[1]															
Bit	15	14	13	12	11	10	9	8	7	6	5	4	3	2	1	0
Bin	0	0	0	0	0	0	0	0	0	0	0	0	0	0	0	0
Hex	0				0				0				0			

#### Status with mirrored control code

Word	IN[0]															
Bit	15	14	13	12	11	10	9	8	7	6	5	4	3	2	1	0
Bin	0	0	1	1	1	1	0	0	0	0	0	0	0	0	0	0
Hex	3				C				0				0			

#### Firmware version (e.g., 100) and sub ID (F)

Word	IN[1]															
Bit	15	14	13	12	11	10	9	8	7	6	5	4	3	2	1	0
Bin	0	0	0	1	0	0	0	0	0	0	0	0	1	1	1	1
Hex	1				0				0				F			



Компания «ЭлектроПласт» предлагает заключение долгосрочных отношений при поставках импортных электронных компонентов на взаимовыгодных условиях!

Наши преимущества:

- Оперативные поставки широкого спектра электронных компонентов отечественного и импортного производства напрямую от производителей и с крупнейших мировых складов;
- Поставка более 17-ти миллионов наименований электронных компонентов;
- Поставка сложных, дефицитных, либо снятых с производства позиций;
- Оперативные сроки поставки под заказ (от 5 рабочих дней);
- Экспресс доставка в любую точку России;
- Техническая поддержка проекта, помощь в подборе аналогов, поставка прототипов;
- Система менеджмента качества сертифицирована по Международному стандарту ISO 9001;
- Лицензия ФСБ на осуществление работ с использованием сведений, составляющих государственную тайну;
- Поставка специализированных компонентов (Xilinx, Altera, Analog Devices, Intersil, Interpoint, Microsemi, Aeroflex, Peregrine, Syfer, Eurofarad, Texas Instrument, Miteq, Cobham, E2V, MA-COM, Hittite, Mini-Circuits, General Dynamics и др.);

Помимо этого, одним из направлений компании «ЭлектроПласт» является направление «Источники питания». Мы предлагаем Вам помощь Конструкторского отдела:

- Подбор оптимального решения, техническое обоснование при выборе компонента;
- Подбор аналогов;
- Консультации по применению компонента;
- Поставка образцов и прототипов;
- Техническая поддержка проекта;
- Защита от снятия компонента с производства.



#### Как с нами связаться

**Телефон:** 8 (812) 309 58 32 (многоканальный)

**Факс:** 8 (812) 320-02-42

**Электронная почта:** [org@eplast1.ru](mailto:org@eplast1.ru)

**Адрес:** 198099, г. Санкт-Петербург, ул. Калинина, дом 2, корпус 4, литера А.