



FLEx36™ 3.3 V (64 K × 36) Synchronous Dual-Port RAM

Features

- True dual-ported memory cells that enable simultaneous access of the same memory location
- Synchronous pipelined operation
- Pipelined output mode allows fast operation
- 0.18 micron complementary metal oxide semiconductor (CMOS) for optimum speed and power
- High speed clock to data access
- 3.3 V low power
 - Active as low as 225 mA (typ.)
 - Standby as low as 55 mA (typ.)
- Mailbox function for message passing
- Global master reset
- Separate byte enables on both ports
- Commercial and industrial temperature ranges
- IEEE 1149.1-compatible joint test action group (JTAG) boundary scan
- 256 Ball fine-pitch ball grid array (FBGA) (1-mm pitch)
- Counter wrap around control
 - Internal mask register controls counter wrap-around
 - Counter-interrupt flags to indicate wrap-around
 - Memory block retransmit operation
- Counter readback on address lines
- Mask register readback on address lines
- Dual chip enables on both ports for easy depth expansion
- Seamless migration to next-generation dual-port family

Functional Description

The FLEx36™ family includes 2-Mbit pipelined, synchronous, true dual-port static RAMs that are high speed, low power 3.3 V CMOS. Two ports are provided, permitting independent, simultaneous access to any location in memory. A particular port can write to a certain location while another port is reading that location. The result of writing to the same location by more than one port at the same time is undefined. Registers on control, address, and data lines allow for minimal setup and hold time.

During a Read operation, data is registered for decreased cycle time. Each port contains a burst counter on the input address register. After externally loading the counter with the initial address, the counter increments the address internally (more details to follow). The internal Write pulse width is independent of the duration of the R/W input signal. The internal Write pulse is self-timed to allow the shortest possible cycle times.

A HIGH on $\overline{CE0}$ or LOW on CE1 for one clock cycle powers down the internal circuitry to reduce the static power consumption. One cycle with chip enables asserted is required to reactivate the outputs.

Additional features include: readback of burst-counter internal address value on address lines, counter-mask registers to control the counter wrap-around, counter interrupt (CNTINT) flags, readback of mask register value on address lines, retransmit functionality, interrupt flags for message passing, JTAG for boundary scan, and asynchronous Master Reset (MRST).

Seamless Migration to Next-Generation Dual-Port Family

Cypress offers a migration path for all devices in this family to the next-generation devices in the Dual-Port family with a compatible footprint. Please contact Cypress Sales for more details.

For a complete list of related documentation, [click here](#).

Product Selection Guide

Density	2-Mbit (64 K × 36)
Part number	CYD02S36V/36VA
Max. speed (MHz)	167
Max. access time – clock to data (ns)	4.4
Typical operating current (mA)	225
Package	256 FBGA (17 mm x 17 mm)

Logic Block Diagram

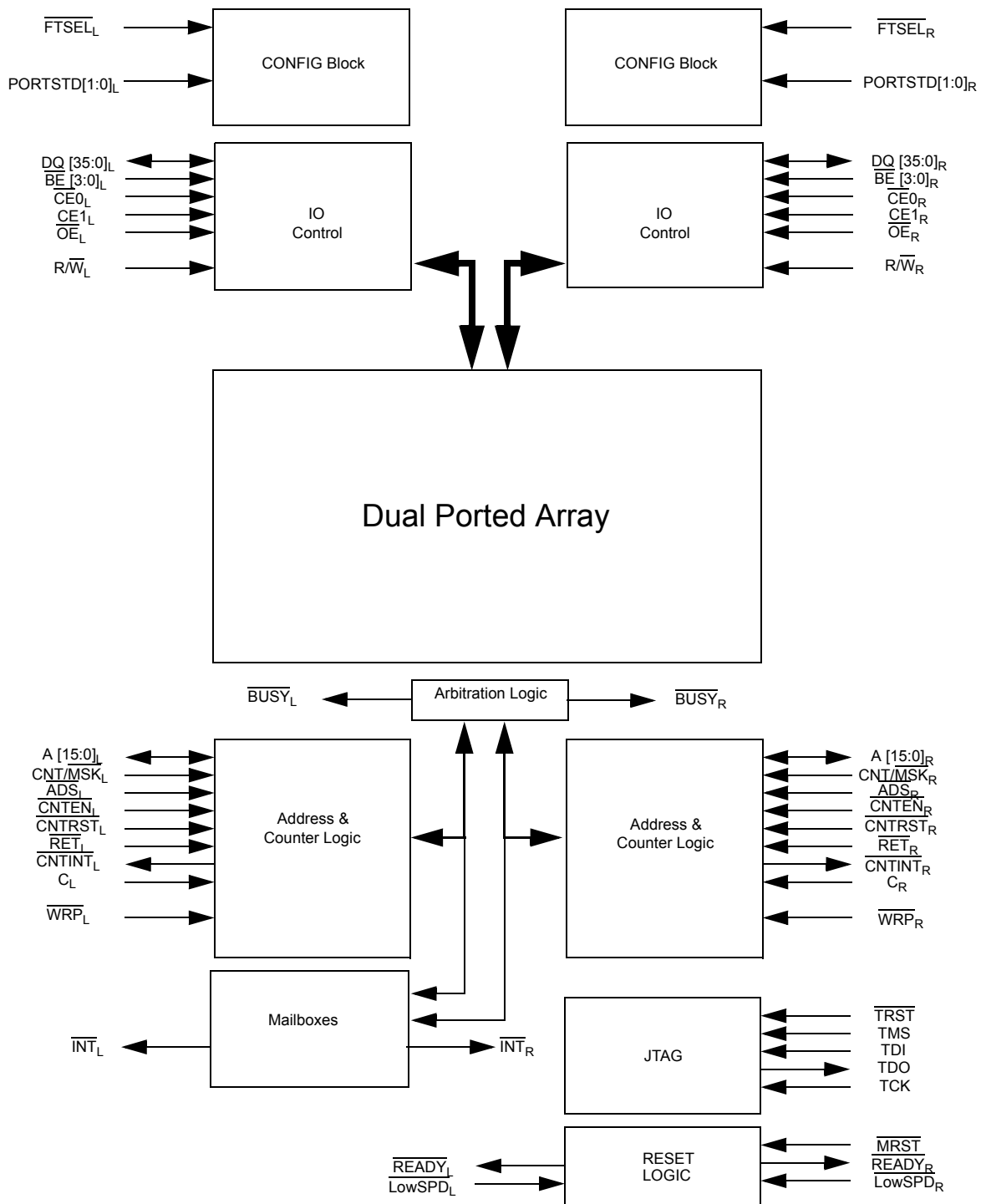

Contents

Pin Configurations	4	Electrical Characteristics	12
Pin Definitions	5	Capacitance	12
Master Reset	6	Switching Characteristics	13
Mailbox Interrupts	6	JTAG Timing	14
Address Counter and Mask Register Operations	6	JTAG Switching Waveform	15
Counter Reset Operation	7	Switching Waveforms	15
Counter Load Operation	7	Ordering Information	25
Counter Increment Operation	8	64 K × 36 (2-Mbit) 3.3 V	
Counter Hold Operation	8	Synchronous CYD02S36V Dual-Port SRAM	25
Counter Interrupt	8	Ordering Code Definitions	25
Counter Readback Operation	8	Package Diagram	26
Retransmit	8	Acronyms	27
Mask Reset Operation	8	Document Conventions	27
Mask Load Operation	8	Units of Measure	27
Mask Readback Operation	8	Document History Page	28
Counting by Two	8	Sales, Solutions, and Legal Information	29
IEEE 1149.1 Serial Boundary Scan (JTAG)^[18]	10	Worldwide Sales and Design Support	29
Performing a TAP Reset	10	Products	29
Performing a Pause/Restart	10	PSoC® Solutions	29
Maximum Ratings	12	Cypress Developer Community	29
Operating Range	12	Technical Support	29

Pin Configurations

Figure 1. Pin Diagram - 256-ball FBGA (Top View)

CYD02S36V/36VA																
	1	2	3	4	5	6	7	8	9	10	11	12	13	14	15	16
A	DQ32L	DQ30L	DQ28L	DQ26L	DQ24L	DQ22L	DQ20L	DQ18L	DQ18R	DQ20R	DQ22R	DQ24R	DQ26R	DQ28R	DQ30R	DQ32R
B	DQ33L	DQ31L	DQ29L	DQ27L	DQ25L	DQ23L	DQ21L	DQ19L	DQ19R	DQ21R	DQ23R	DQ25R	DQ27R	DQ29R	DQ31R	DQ33R
C	DQ34L	DQ35L	$\overline{\text{RETL}}$ [1,2]	$\overline{\text{INTL}}$	NC [1,4]	NC [1,4]	REVL [1,3]	$\overline{\text{TRST}}$ [1,4]	$\overline{\text{MRST}}$	NC [1,4]	NC [1,4]	NC [1,4]	$\overline{\text{INTR}}$	$\overline{\text{RETR}}$ [1,2]	DQ35R	DQ34R
D	A0L	A1L	$\overline{\text{WRPL}}$ [1,2]	VREFL [1,3]	$\overline{\text{FTSELL}}$ [1,2]	$\overline{\text{LOWSPDL}}$ [1,3]	VSS	VTTL	VTTL	VSS	$\overline{\text{LOWSPDR}}$ [1,3]	$\overline{\text{FTSELR}}$ [1,2]	VREFL [1,3]	$\overline{\text{WRPR}}$ [1,2]	A1R	A0R
E	A2L	A3L	$\overline{\text{CE0L}}$	CE1L	VDDIOL	VDDIOL	VDDIOL	VCORE	VCORE	VDDIOR	VDDIOR	VDDIOR	CE1R	$\overline{\text{CE0R}}$	A3R	A2R
F	A4L	A5L	$\overline{\text{CNTINTL}}$	$\overline{\text{BE3L}}$	VDDIOL	VSS	VSS	VSS	VSS	VSS	VSS	VDDIOR	$\overline{\text{BE3R}}$	$\overline{\text{CNTINTR}}$	A5R	A4R
G	A6L	A7L	$\overline{\text{BUSYL}}$ [1,4]	$\overline{\text{BE2L}}$	REVL [1,2]	VSS	VSS	VSS	VSS	VSS	VSS	VDDIOR	$\overline{\text{BE2R}}$	$\overline{\text{BUSYR}}$ [1,4]	A7R	A6R
H	A8L	A9L	CL	VTTL	VCORE	VSS	VSS	VSS	VSS	VSS	VSS	VCORE	VTTL	CR	A9R	A8R
J	A10L	A11L	VSS	PORTSTD1L [1,3]	VCORE	VSS	VSS	VSS	VSS	VSS	VSS	VCORE	PORTSTD1R [1,3]	VSS	A11R	A10R
K	A12L	A13L	$\overline{\text{OE1L}}$	$\overline{\text{BE1L}}$	VDDIOL	VSS	VSS	VSS	VSS	VSS	VSS	VDDIOR	$\overline{\text{BE1R}}$	$\overline{\text{OER}}$	A13R	A12R
L	A14L	A15L	$\overline{\text{ADSL}}$	$\overline{\text{BE0L}}$	VDDIOL	VSS	VSS	VSS	VSS	VSS	VSS	VDDIOR	$\overline{\text{BE0R}}$	$\overline{\text{ADSR}}$	A15R	A14R
M	NC [1,4]	NC [1,4]	$\overline{\text{RWL}}$	REVL [1,3]	VDDIOL	VDDIOL	VDDIOL	VCORE	VCORE	VDDIOR	VDDIOR	VDDIOR	REVR [1,3]	$\overline{\text{RWR}}$	NC [1,4]	NC [1,4]
N	NC [1,4]	NC [1,4]	CNT/MSKL	VREFL [1,3]	PortSTD0L [1,3]	READYL [1,4]	REVL [1,2]	VTTL	VTTL	REVR [1,2]	READYR [1,4]	PortSTD0R [1,3]	VREFR [1,3]	CNT/MSKR	NC [1,4]	NC [1,4]
P	DQ16L	DQ17L	$\overline{\text{CNTENL}}$	$\overline{\text{CNTRSTL}}$	NC [1,4]	NC [1,4]	TCK	TMS	TDO	TDI	NC [1,4]	NC [1,4]	$\overline{\text{CNTRSTR}}$	$\overline{\text{CNTENR}}$	DQ17R	DQ16R
R	DQ15L	DQ13L	DQ11L	DQ9L	DQ7L	DQ5L	DQ3L	DQ1L	DQ1R	DQ3R	DQ5R	DQ7R	DQ9R	DQ11R	DQ13R	DQ15R
T	DQ14L	DQ12L	DQ10L	DQ8L	DQ6L	DQ4L	DQ2L	DQ0L	DQ0R	DQ2R	DQ4R	DQ6R	DQ8R	DQ10R	DQ12R	DQ14R

Notes

1. This ball represents a next generation Dual-Port feature. For more information about this feature, contact Cypress Sales.
2. Connect this ball to VDDIO. For more information about this next generation Dual-Port feature contact Cypress Sales.
3. Connect this ball to VSS. For more information about this next generation Dual-Port feature, contact Cypress Sales.
4. Leave this ball unconnected. For more information about this feature, contact Cypress Sales.

Pin Definitions

Left Port	Right Port	Description
A _{0L} -A _{15L}	A _{0R} -A _{15R}	Address inputs
BE _{0L} -BE _{3L}	BE _{0R} -BE _{3R}	Byte enable inputs. Asserting these signals enables Read and Write operations to the corresponding bytes of the memory array.
BUSY _L ^[5,8]	BUSY _R ^[5,8]	Port busy output. When the collision is detected, a $\overline{\text{BUSY}}$ is asserted.
C _L	C _R	Input clock signal
CE _{0L}	CE _{0R}	Active low chip enable input
CE _{1L}	CE _{1R}	Active high chip enable input
DQ _{0L} -DQ _{35L}	DQ _{0R} -DQ _{35R}	Data bus input/output.
OE _L	OE _R	Output enable input. This asynchronous signal must be asserted LOW to enable the DQ data pins during read operations.
INT _L	INT _R	Mailbox interrupt flag output. The mailbox permits communications between ports. The upper two memory locations can be used for message passing. INT _L is asserted LOW when the right port writes to the mailbox location of the left port, and vice versa. An interrupt to a port is deasserted HIGH when it reads the contents of its mailbox.
LowSPD _L ^[5,7]	LowSPD _R ^[5,7]	Port low speed select input.
PORTSTD[1:0] _L ^[5,7]	PORTSTD[1:0] _R ^[5,7]	Port address/control/data io standard select inputs.
R/W _L	R/W _R	Read/write enable input. Assert this pin LOW to write to, or HIGH to Read from the dual port memory array.
READY _L ^[5,8]	READY _R ^[5,8]	Port ready output. This signal is asserted when a port is ready for normal operation.
CNT/MSK _L	CNT/MSK _R	Port counter/mask select input. Counter control input.
ADS _L	ADS _R	Port counter address load strobe input. Counter control input.
CNTEN _L	CNTEN _R	Port counter enable input. Counter control input.
CNTRST _L	CNTRST _R	Port counter reset input. Counter control input.
CNTINT _L	CNTINT _R	Port counter interrupt output. This pin is asserted LOW when the unmasked portion of the counter is incremented to all "1s".
WRP _L ^[5,6]	WRP _R ^[5,6]	Port counter wrap input. The burst counter wrap control input.
RET _L ^[5,6]	RET _R ^[5,6]	Port counter retransmit input. Counter control input.
FTSEL _L ^[5,6]	FTSEL _R ^[5,6]	Flow-through select. Use this pin to select Flow-Through mode. When is de-asserted, the device is in pipelined mode.
VREF _L ^[5,7]	VREF _R ^[5,7]	Port external high-speed io reference input.
V _{DDIOL}	V _{DDIOR}	Port I/O power supply.
REV _L ^[5,6,7]	REV _R ^[5,6,7]	Reserved pins for future features.
MRST		Master reset input. MRST is an asynchronous input signal and affects both ports. A master reset operation is required at power up.
TRST ^[5,8]		JTAG reset input.
TMS		JTAG test mode select input. It controls the advance of JTAG TAP state machine. State machine transitions occur on the rising edge of TCK.
TDI		JTAG test data input. Data on the TDI input is shifted serially into selected registers.
TCK		JTAG test clock input.
TDO		JTAG test data output. TDO transitions occur on the falling edge of TCK. TDO is normally three-stated except when captured data is shifted out of the JTAG TAP.
V _{SS}		Ground inputs.

Notes

5. This ball represents a next generation Dual-Port feature. For more information about this feature, contact Cypress Sales.
6. Connect this ball to VDDIO. For more information about this next generation Dual-Port feature contact Cypress Sales.
7. Connect this ball to VSS. For more information about this next generation Dual-Port feature, contact Cypress Sales.
8. Leave this ball unconnected. For more information about this feature, contact Cypress Sales.

Pin Definitions (continued)

Left Port	Right Port	Description
$V_{CORE}^{[9]}$		Core power supply.
V_{TTL}		LVTTL power supply for JTAG IOs

Master Reset

The FLE_x36 family devices undergo a complete reset by taking its MRST input LOW. The MRST input can switch asynchronously to the clocks. An MRST initializes the internal burst counters to zero, and the counter mask registers to all ones (completely unmasked). MRST also forces the Mailbox Interrupt (INT) flags and the Counter Interrupt (CNTINT) flags HIGH. MRST must be performed on the FLE_x36 family devices after power up.

Mailbox Interrupts

The upper two memory locations may be used for message passing and permit communications between ports. Table 1 shows the interrupt operation for both ports of CYD02S36V/36VA. The highest memory location, FFFF is the mailbox for the right port and FFFE is the mailbox for the left port. Table 1 shows that to set the INT_R flag, a Write operation by the left port to address FFFF asserts INT_R LOW. At least one byte must be active for a Write to generate an interrupt. A valid Read of the FFFF location by the right port resets INT_R HIGH. At least one byte must be active in order for a Read to reset the interrupt. When one port Writes to the other port's mailbox, the INT of the port that the mailbox belongs to is asserted LOW. The INT is reset when the owner (port) of the mailbox Reads the contents of the mailbox. The interrupt flag is set in a flow-thru mode (i.e., it follows the clock edge of the writing port). Also, the flag is reset in a flow-thru mode (i.e., it follows the clock edge of the reading port).

Each port can read the other port's mailbox without resetting the interrupt. And each port can write to its own mailbox without setting the interrupt. If an application does not require message passing, INT pins must be left open.

Table 1. Interrupt Operation Example ^[10, 11, 12, 13]

Function	Left Port				Right Port			
	R/W _L	CE _L	A _{0L-15L}	INT _L	R/W _R	CE _R	A _{0R-15R}	INT _R
Set Right INT _R Flag	L	L	FFFF	X	X	X	X	L
Reset Right INT _R Flag	X	X	X	X	H	L	FFFF	H
Set Left INT _L Flag	X	X	X	L	L	L	FFFE	X
Reset Left INT _L Flag	H	L	FFFE	H	X	X	X	X

Notes

9. This family of Dual-Ports does not use V_{CORE}, and these pins are internally NC. The next generation Dual-Port family, the FLE_x36-E™, uses V_{CORE} of 1.5 V or 1.8V. Please contact local Cypress FAE for more information.
10. CE is internal signal. CE = LOW if CE₀ = LOW and CE₁ = HIGH. For a single Read operation, CE only needs to be asserted once at the rising edge of the CLK and can be deasserted after that. Data is out after the following CLK edge and is three-stated after the next CLK edge.
11. OE is "Don't Care" for mailbox operation.
12. At least one of BE₀, BE₁, BE₂, or BE₃ must be LOW.
13. "X" = "Don't Care," "H" = HIGH, "L" = LOW.

Address Counter and Mask Register Operations

Each port of these devices has a programmable burst address counter. The burst counter contains three registers: a counter register, a mask register, and a mirror register.

The **counter register** contains the address used to access the RAM array. It is changed only by the Counter Load, Increment, Counter Reset, and by master reset (MRST) operations.

The **mask register** value affects the Increment and Counter Reset operations by preventing the corresponding bits of the counter register from changing. It also affects the counter interrupt output (CNTINT). The mask register is changed only by the Mask Load and Mask Reset operations, and by the MRST. The mask register defines the counting range of the counter register. It divides the counter register into two regions: zero or more "0s" in the most significant bits define the masked region, one or more "1s" in the least significant bits define the unmasked region. Bit 0 may also be "0," masking the least significant counter bit and causing the counter to increment by two instead of one.

The **mirror register** is used to reload the counter register on increment operations (see "retransmit," below). It always contains the value last loaded into the counter register, and is changed only by the Counter Load, and Counter Reset operations, and by the MRST.

Table 2 on page 7 summarizes the operation of these registers and the required input control signals. The MRST control signal is asynchronous. All the other control signals in Table 2 on page 7 (CNT/MSK, CNTRST, ADS, CNTEN) are synchronized to the port's CLK. All these counter and mask operations are independent of the port's chip enable inputs (CE0 and CE1).

Counter enable ($\overline{\text{CNTEN}}$) inputs are provided to stall the operation of the address input and use the internal address generated by the internal counter for fast, interleaved memory applications. A port's burst counter is loaded when the port's address strobe ($\overline{\text{ADS}}$) and $\overline{\text{CNTEN}}$ signals are LOW. When the port's $\overline{\text{CNTEN}}$ is asserted and the $\overline{\text{ADS}}$ is deasserted, the address counter increments on each LOW to HIGH transition of that port's clock signal. This Read's or Write's one word from/into each successive address location until $\overline{\text{CNTEN}}$ is deasserted. The counter can address the entire memory array, and loops back to the start. Counter reset ($\overline{\text{CNTRST}}$) is used to reset the unmasked portion of the burst counter to 0s. A counter-mask register is used to control the counter wrap.









Counter Reset Operation

All unmasked bits of the counter and mirror registers are reset to "0." All masked bits remain unchanged. A Mask Reset followed by a Counter Reset resets the counter and mirror registers to 0000, as does master reset ($\overline{\text{MRST}}$).

Counter Load Operation

The address counter and mirror registers are both loaded with the address value presented at the address lines.

Table 2. Address Counter and Counter-Mask Register Control Operation (Any Port) ^[14, 15]

CLK	$\overline{\text{MRST}}$	$\overline{\text{CNT/MSK}}$	$\overline{\text{CNTRST}}$	$\overline{\text{ADS}}$	$\overline{\text{CNTEN}}$	Operation	Description
X	L	X	X	X	X	Masterreset	Reset address counter to all 0s and mask register to all 1s.
	H	H	L	X	X	Counter reset	Reset counter unmasked portion to all 0s.
	H	H	H	L	L	Counter load	Load counter with external address value presented on address lines.
	H	H	H	L	H	Counter readback	Read out counter internal value on address lines.
	H	H	H	H	L	Counter increment	Internally increment address counter value.
	H	H	H	H	H	Counter hold	Constantly hold the address value for multiple clock cycles.
	H	L	L	X	X	Mask reset	Reset mask register to all 1s.
	H	L	H	L	L	Mask load	Load mask register with value presented on the address lines.
	H	L	H	L	H	Mask readback	Read out mask register value on address lines.
	H	L	H	H	X	Reserved	Operation undefined

Notes

- 14. "X" = "Don't Care," "H" = HIGH, "L" = LOW.
- 15. Counter operation and mask register operation is independent of chip enables.

Counter Increment Operation

Once the address counter register is initially loaded with an external address, the counter can internally increment the address value, potentially addressing the entire memory array. Only the unmasked bits of the counter register are incremented. The corresponding bit in the mask register must be a “1” for a counter bit to change. The counter register is incremented by 1 if the least significant bit is unmasked, and by 2 if it is masked. If all unmasked bits are “1,” the next increment wraps the counter back to the initially loaded value. If an Increment results in all the unmasked bits of the counter being “1s,” a counter interrupt flag (CNTINT) is asserted. The next Increment returns the counter register to its initial value, which was stored in the mirror register. The counter address can instead be forced to loop to 0000 by externally connecting CNTINT to CNTRST.^[16] An increment that results in one or more of the unmasked bits of the counter being “0” de-asserts the counter interrupt flag. The example in Figure 3 on page 10 shows the counter mask register loaded with a mask value of 003Fh unmasking the first 6 bits with bit “0” as the LSB and bit “16” as the MSB. The maximum value the mask register can be loaded with is FFFFh. Setting the mask register to this value allows the counter to access the entire memory space. The address counter is then loaded with an initial value of 8h. The base address bits (in this case, the 6th address through the 16th address) are loaded with an address value but do not increment once the counter is configured for increment operation. The counter address starts at address 8h. The counter increments its internal address value till it reaches the mask register value of 3Fh. The counter wraps around the memory block to location 8h at the next count. CNTINT is issued when the counter reaches its maximum value.

Counter Hold Operation

The value of all three registers can be constantly maintained unchanged for an unlimited number of clock cycles. Such operation is useful in applications where wait states are needed, or when address is available a few cycles ahead of data in a shared bus interface.

Counter Interrupt

The counter interrupt (CNTINT) is asserted LOW when an increment operation results in the unmasked portion of the counter register being all “1s.” It is deasserted HIGH when an Increment operation results in any other value. It is also de-asserted by Counter Reset, Counter Load, Mask Reset and Mask Load operations, and by MRST.

Counter Readback Operation

The internal value of the counter register can be read out on the address lines. Readback is pipelined; the address is valid t_{CA2}

after the next rising edge of the port’s clock. If address readback occurs while the port is enabled (CE0 LOW and CE1 HIGH), the data lines (DQs) are three-stated. Figure 2 on page 9 shows a block diagram of the operation.

Retransmit

Retransmit is a feature that allows the Read of a block of memory more than once without the need to reload the initial address. This eliminates the need for external logic to store and route data. It also reduces the complexity of the system design and saves board space. An internal “mirror register” is used to store the initially loaded address counter value. When the counter unmasked portion reaches its maximum value set by the mask register, it wraps back to the initial value stored in this “mirror register.” If the counter is continuously configured in increment mode, it increments again to its maximum value and wraps back to the value initially stored into the “mirror register.” Thus, the repeated access of the same data is allowed without the need for any external logic.

Mask Reset Operation

The mask register is reset to all “1s,” which unmask every bit of the counter. Master reset (MRST) also resets the mask register to all “1s.”

Mask Load Operation

The mask register is loaded with the address value presented at the address lines. Not all values permit correct increment operations. Permitted values are of the form $2^n - 1$ or $2^n - 2$. From the most significant bit to the least significant bit, permitted values have zero or more “0s,” one or more “1s,” or one “0.” Thus FFFF, 03FE, and 0001 are permitted values, but F0FF, 03FC, and 0000 are not.

Mask Readback Operation

The internal value of the mask register can be read out on the address lines. Readback is pipelined; the address is valid t_{CM2} after the next rising edge of the port’s clock. If mask readback occurs while the port is enabled (CE0 LOW and CE1 HIGH), the data lines (DQs) are three-stated. Figure 2 on page 9 shows a block diagram of the operation.

Counting by Two

When the least significant bit of the mask register is “0,” the counter increments by two. This may be used to connect the x36 devices as a 72-bit single port SRAM in which the counter of one port counts even addresses and the counter of the other port counts odd addresses. This even-odd address scheme stores one half of the 72-bit data in even memory locations, and the other half in odd memory locations.

Note

16. CNTINT and CNTRST specs are guaranteed by design to operate properly at speed grade operating frequency when tied together.

Figure 2. Counter, Mask, and Mirror Logic Block Diagram^[1]



Figure 3. Programmable Counter-Mask Register Operation^{17/1}

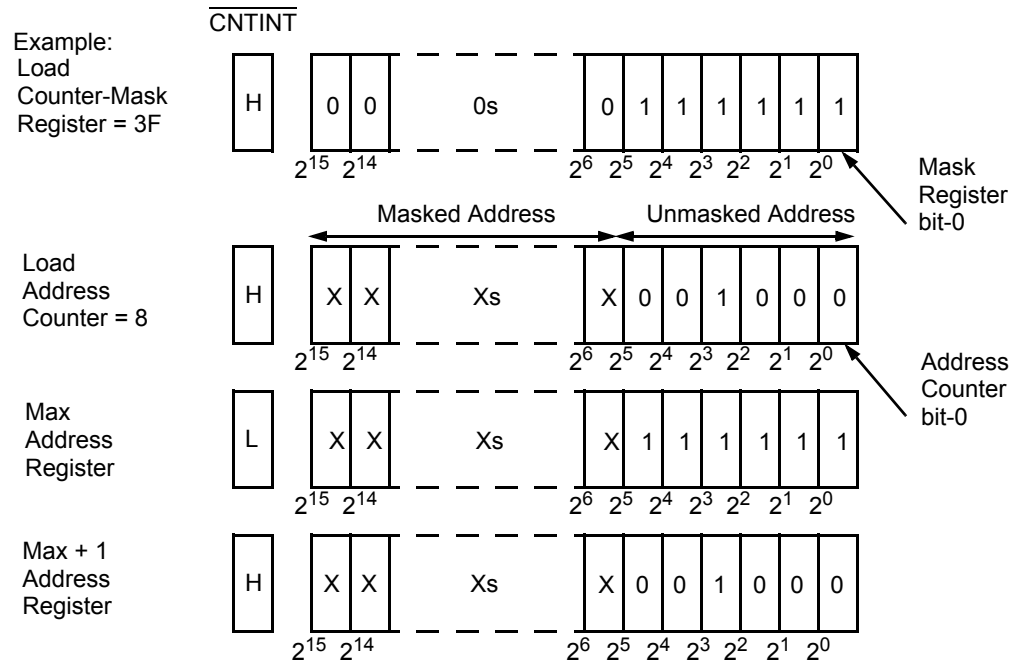

IEEE 1149.1 Serial Boundary Scan (JTAG)^{18]}

The FLEx36 family devices incorporate an IEEE 1149.1 serial boundary scan test access port (TAP). The TAP controller functions in a manner that does not conflict with the operation of other devices using 1149.1-compliant TAPs. The TAP operates using JEDEC-standard 3.3V IO logic levels. It is composed of three input connections and one output connection required by the test logic defined by the standard.

Performing a TAP Reset

A reset is performed by forcing TMS HIGH (V_{DD}) for five rising edges of TCK. This reset does not affect the operation of the

devices, and may be performed while the device is operating. An MRST must be performed on the devices after power up.

Performing a Pause/Restart

When a SHIFT-DR PAUSE-DR SHIFT-DR is performed the scan chain outputs the next bit in the chain twice. For example, if the value expected from the chain is 1010101, the device outputs a 11010101. This extra bit causes some testers to report an erroneous failure for the devices in a scan test. Therefore the tester must be configured to never enter the PAUSE-DR state.

Table 3. Identification Register Definitions

Instruction Field	Value	Description
Revision number (31:28)	0h	Reserved for version number.
Cypress device ID (27:12)	C001h	Defines Cypress part number for CYD02S36V/36VA
Cypress JEDEC ID (11:1)	034h	Allows unique identification of the DP family device vendor.
ID register presence (0)	1	Indicates the presence of an ID register.

Notes

17. The "X" in this diagram represents the counter upper bits.

18. Boundary scan is IEEE 1149.1-compatible. See "Performing a Pause/Restart" for deviation from strict 1149.1 compliance.

Table 4. Scan Register Sizes

Register Name	Bit Size
Instruction	4
Bypass	1
Identification	32
Boundary Scan	n ^[19]

Table 5. Instruction Identification Codes

Instruction	Code	Description
EXTEST	0000	Captures the input/output ring contents. Places the BSR between the TDI and TDO.
BYPASS	1111	Places the BYR between TDI and TDO.
IDCODE	1011	Loads the IDR with the vendor ID code and places the register between TDI and TDO.
HIGHZ	0111	Places BYR between TDI and TDO. Forces all device output drivers to a High-Z state.
CLAMP	0100	Controls boundary to 1/0. Places BYR between TDI and TDO.
SAMPLE/PRELOAD	1000	Captures the input/output ring contents. Places BSR between TDI and TDO.
NBSRST	1100	Resets the non-boundary scan logic. Places BYR between TDI and TDO.
RESERVED	All other codes	Other combinations are reserved. Do not use other than the above.

Note

19. See details in the device BSDL files.

Maximum Ratings

Exceeding maximum ratings^[20] may shorten the useful life of the device. User guidelines are not tested.

Storage Temperature -65 °C to +150 °C

Ambient Temperature with

Power Applied -55 °C to +125 °C

Supply Voltage to Ground Potential.....-0.5 V to +4.6 V

DC Voltage Applied to

Outputs in High-Z State -0.5 V to $V_{DD} + 0.5 V$

DC Input Voltage -0.5 V to $V_{DD} + 0.5 V$ ^[21]

Output Current into Outputs (LOW)..... 20 mA

Static Discharge Voltage..... > 2000 V

(JEDEC JESD22-A114-2000B)

Latch-up Current..... > 200 mA

Operating Range

Range	Ambient Temperature	V_{DDIO}/V_{TTL}	V_{CORE} ^[22]
Commercial	0 °C to +70 °C	3.3 V±165 mV	1.8 V±100 mV

Electrical Characteristics

Over the Operating Range

Parameter	Description	-167			Unit
		Min	Typ	Max	
V_{OH}	Output HIGH voltage ($V_{DD} = \text{Min}$, $I_{OH} = -4.0 \text{ mA}$)	2.4	–	–	V
V_{OL}	Output LOW voltage ($V_{DD} = \text{Min}$, $I_{OL} = +4.0 \text{ mA}$)	–	–	0.4	V
V_{IH}	Input HIGH voltage	2.0	–	–	V
V_{IL}	Input LOW voltage	–	–	0.8	V
I_{OZ}	Output leakage current	-10	–	10	μA
I_{IX1}	Input leakage current except TDI, TMS, $\overline{\text{MRST}}$	-10	–	10	μA
I_{IX2}	Input leakage current TDI, TMS, $\overline{\text{MRST}}$	-1.0	–	0.1	mA
I_{CC}	Operating current for ($V_{DD} = \text{Max}$, $I_{OUT} = 0 \text{ mA}$), outputs disabled	–	225	300	mA
I_{SB1}	Standby current (both ports TTL level) CE_L and $CE_R \geq V_{IH}$, $f = f_{MAX}$	–	90	115	mA
I_{SB2}	Standby current (one port TTL level) $CE_L CE_R \geq V_{IH}$, $f = f_{MAX}$	–	160	210	mA
I_{SB3}	Standby current (both ports CMOS level) CE_L and $CE_R \geq V_{DD} - 0.2V$, $f = 0$	–	55	75	mA
I_{SB4}	Standby current (one port CMOS level) $CE_L CE_R \geq V_{IH}$, $f = f_{MAX}$	–	160	210	mA
I_{CORE} ^[22]	Core operating current for ($V_{DD} = \text{Max}$, $I_{OUT} = 0 \text{ mA}$), outputs disabled	–	0	0	mA

Capacitance

Part Number	Parameter ^[23]	Description	Test Conditions	Max	Unit
CYD02S36V/36VA/	C_{IN}	Input capacitance	$T_A = 25 \text{ °C}$, $f = 1 \text{ MHz}$, $V_{DD} = 3.3 \text{ V}$	13	pF
	C_{OUT}	Output capacitance		10	pF

Notes

20. The voltage on any input or IO pin cannot exceed the power pin during power up.

21. Pulse width < 20 ns.

22. This family of Dual-Ports does not use V_{CORE} , and these pins are internally NC. The next generation Dual-Port family, the FLEx36-E™, uses V_{CORE} of 1.5V or 1.8V. Please contact local Cypress FAE for more information

23. C_{OUT} also references C_{IO} .

Figure 4. AC Test Load and Waveforms



Switching Characteristics

Over the Operating Range

Parameter	Description	-167		Unit
		CYD02S36V/CYD02S36VA		
		Min	Max	
f_{MAX2}	Maximum operating frequency	–	167	MHz
t_{CYC2}	Clock cycle time	6.0	–	ns
t_{CH2}	Clock HIGH time	2.7	–	ns
t_{CL2}	Clock LOW time	2.7	–	ns
$t_R^{[24]}$	Clock rise time	–	2.0	ns
$t_F^{[24]}$	Clock fall time	–	2.0	ns
t_{SA}	Address setup time	2.3	–	ns
t_{HA}	Address hold time	0.6	–	ns
t_{SB}	Byte select setup time	2.3	–	ns
t_{HB}	Byte select hold time	0.6	–	ns
t_{SC}	Chip enable setup time	2.3	–	ns
t_{HC}	Chip enable hold time	0.6	–	ns
t_{SW}	R/W setup time	2.3	–	ns
t_{HW}	R/W hold time	0.6	–	ns
t_{SD}	Input data setup time	2.3	–	ns
t_{HD}	Input data hold time	0.6	–	ns
t_{SAD}	ADS setup time	2.3	–	ns
t_{HAD}	ADS hold time	0.6	–	ns
t_{SCN}	CNTEN setup time	2.3	–	ns
t_{HCN}	CNTEN hold time	0.6	–	ns
t_{SRST}	CNTRST setup time	2.3	–	ns
t_{HRST}	CNTRST hold time	0.6	–	ns
t_{SCM}	CNT/MSK setup time	2.3	–	ns
t_{HCM}	CNT/MSK hold time	0.6	–	ns
t_{OE}	Output enable to data valid	–	4.4	ns

Note

24. Except JTAG signals (t_r and $t_f < 10\text{ ns}$ [max.]).

Switching Characteristics

Over the Operating Range (continued)

Parameter	Description	-167		Unit
		CYD02S36V/CYD02S36VA		
		Min	Max	
$t_{OLZ}^{[25, 26]}$	OE to Low Z	0	–	ns
$t_{OHZ}^{[25, 26]}$	OE to High Z	0	4.0	ns
t_{CD2}	Clock to data valid	–	4.4	ns
t_{CA2}	Clock to counter address valid	–	4.0	ns
t_{CM2}	Clock to mask register readback valid	–	4.0	ns
t_{DC}	Data output hold after clock HIGH	1.0	–	ns
$t_{CKHZ}^{[25, 26]}$	Clock HIGH to output high Z	0	4.0	ns
$t_{CKLZ}^{[25, 26]}$	Clock HIGH to output low Z	1.0	4.0	ns
t_{SINT}	Clock to INT set time	0.5	6.7	ns
t_{RINT}	Clock to INT reset time	0.5	6.7	ns
t_{SCINT}	Clock to CNTINT set time	0.5	5.0	ns
t_{RCINT}	Clock to CNTINT reset time	0.5	5.0	ns
Port to Port Delays				
t_{CCS}	Clock to clock skew	5.2	–	ns
Master Reset Timing				
t_{RS}	Master reset pulse width	5.0	–	cycles
t_{RS}	Master reset setup time	6.0	–	ns
t_{RSR}	Master reset recovery time	5.0	–	cycles
t_{RSF}	Master reset to outputs inactive	–	10.0	ns
t_{RSINT}	Master reset to counter and mailbox interrupt flag reset time	–	10.0	ns

JTAG Timing

Parameter	Description	167		Unit
		Min	Max	
f_{JTAG}	Maximum JTAG TAP controller frequency	–	10	MHz
t_{TCYC}	TCK clock cycle time	100	–	ns
t_{TH}	TCK clock HIGH time	40	–	ns
t_{TL}	TCK clock LOW time	40	–	ns
t_{TMSS}	TMS setup to TCK clock rise	10	–	ns
t_{TMSH}	TMS hold After TCK clock rise	10	–	ns
t_{TDIS}	TDI setup to TCK clock rise	10	–	ns
t_{TDIH}	TDI hold after TCK clock rise	10	–	ns
t_{TDOV}	TCK clock LOW to TDO valid	–	30	ns
t_{TDOX}	TCK clock LOW to TDO invalid	0	–	ns

Notes

25. This parameter is guaranteed by design, but it is not production tested.
 26. Test conditions used are Load 2.

JTAG Switching Waveform



Switching Waveforms

Figure 5. Master Reset

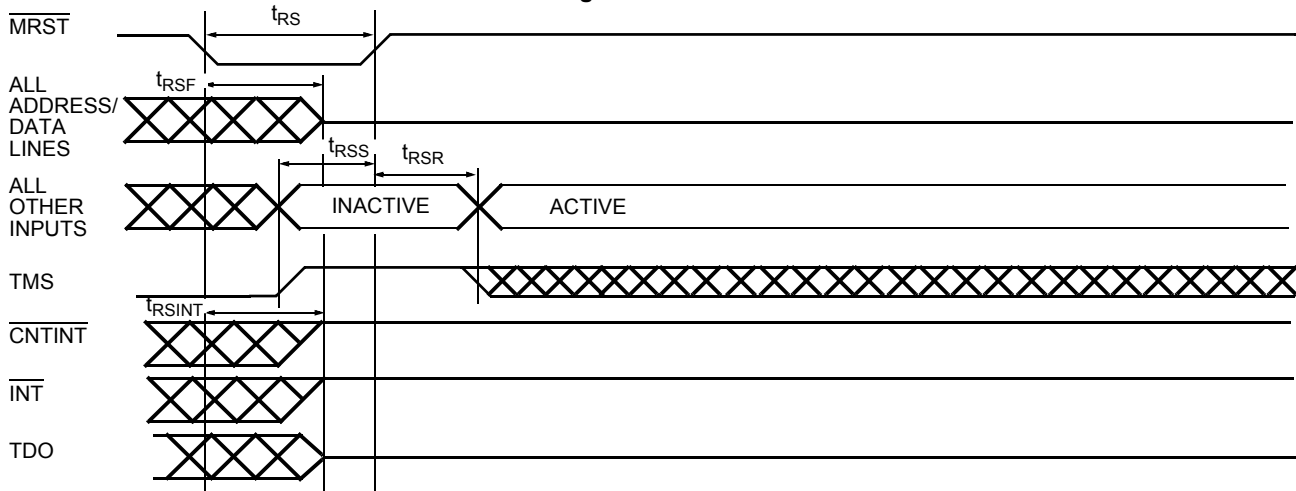

Switching Waveforms (continued)

Figure 6. Read Cycle^[27, 28, 29, 30, 31]



Notes

27. \overline{CE} is internal signal. $\overline{CE} = \text{LOW}$ if $CE0 = \text{LOW}$ and $CE1 = \text{HIGH}$. For a single Read operation, \overline{CE} only needs to be asserted once at the rising edge of the CLK and can be deasserted after that. Data is out after the following CLK edge and is three-stated after the next CLK edge.
28. \overline{OE} is asynchronously controlled; all other inputs (excluding MRST and JTAG) are synchronous to the rising clock edge.
29. $\overline{ADS} = \text{CNTEN} = \text{LOW}$, and $\overline{MRST} = \text{CNTRST} = \text{CNT/MSK} = \text{HIGH}$.
30. The output is disabled (high-impedance state) by $\overline{CE} = V_{IH}$ following the next rising edge of the clock.
31. Addresses do not have to be accessed sequentially since $\overline{ADS} = \text{CNTEN} = V_{IL}$ with $\text{CNT/MSK} = V_{IH}$ constantly loads the address on the rising edge of the CLK. Numbers are for reference only.

Switching Waveforms (continued)

Figure 7. Bank Select Read^[32, 33]

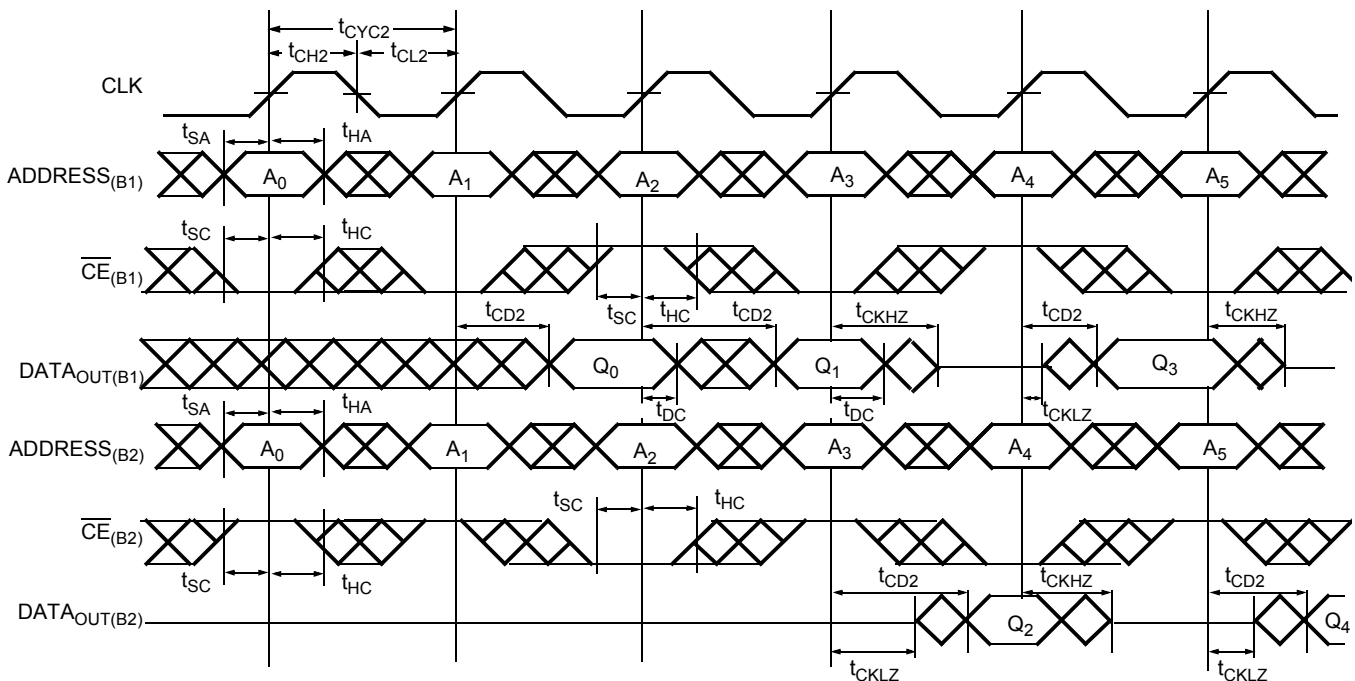

Figure 8. Read-to-Write-to-Read ($\overline{OE} = \text{LOW}$)^[34, 35, 36, 37, 38]



Notes

- 32. In this depth-expansion example, B1 represents Bank #1 and B2 is Bank #2; each bank consists of one Cypress FLEEx36 device from this data sheet. ADDRESS_(B1) = ADDRESS_(B2).
- 33. ADS = CNTEN = BE0 - BE3 = OE = LOW; MRST = CNTRST = CNT/MSK = HIGH.
- 34. Addresses do not have to be accessed sequentially since ADS = CNTEN = V_{IL} with CNT/MSK = V_{IH} constantly loads the address on the rising edge of the CLK. Numbers are for reference only.
- 35. Output state (HIGH, LOW, or high-impedance) is determined by the previous cycle control signals.
- 36. During "No Operation," data in memory at the selected address may be corrupted and must be rewritten to ensure data integrity.
- 37. CE₀ = OE = BE0 - BE3 = LOW; CE₁ = R/W = CNTRST = MRST = HIGH.
- 38. CE₀ = BE0 - BE3 = R/W = LOW; CE₁ = CNTRST = MRST = CNT/MSK = HIGH. When R/W first switches low, since OE = LOW, the Write operation cannot be completed (labelled as no operation). One clock cycle is required to three-state the IO for the Write operation on the next rising edge of CLK.

Switching Waveforms (continued)

Figure 9. Read-to-Write-to-Read (\overline{OE} Controlled)^[39, 40, 41, 42]



Figure 10. Read with Address Counter Advance^[41]

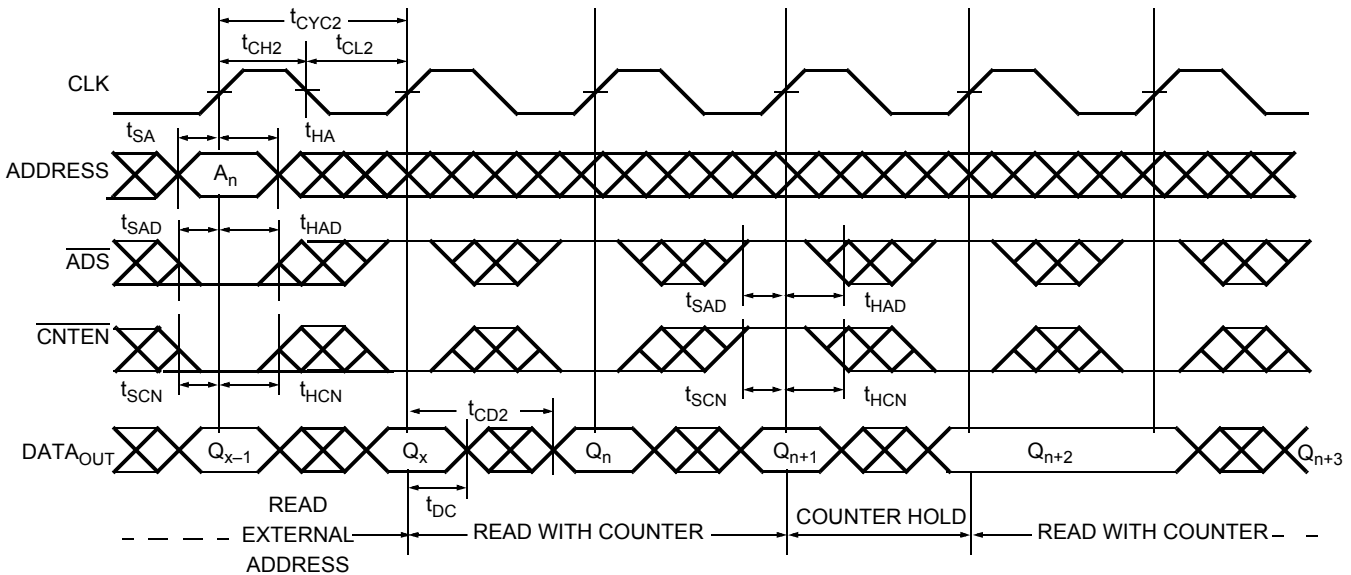

Notes

- 39. Addresses do not have to be accessed sequentially since $\overline{ADS} = \overline{CNTEN} = V_{IL}$ with $CNT/\overline{MSK} = V_{IH}$ constantly loads the address on the rising edge of the CLK. Numbers are for reference only.
- 40. Output state (HIGH, LOW, or high-impedance) is determined by the previous cycle control signals.
- 41. $\overline{CE}_0 = \overline{OE} = \overline{BE}_0 - \overline{BE}_3 = \text{LOW}$; $\overline{CE}_1 = \overline{R/W} = \overline{CNT/MSK} = \text{MRST} = \text{HIGH}$.
- 42. $\overline{CE}_0 = \overline{BE}_0 - \overline{BE}_3 = \overline{R/W} = \text{LOW}$; $\overline{CE}_1 = \overline{CNT/MSK} = \overline{MRST} = \overline{CNT/MSK} = \text{HIGH}$. When $\overline{R/W}$ first switches low, since $\overline{OE} = \text{LOW}$, the Write operation cannot be completed (labelled as no operation). One clock cycle is required to three-state the IO for the Write operation on the next rising edge of CLK.

Switching Waveforms (continued)

Figure 11. Write with Address Counter Advance^[43]



Note
 43. $\overline{CE}_0 = \overline{BE}_0 - \overline{BE}_3 = \text{LOW}$; $CE_1 = \overline{MRST} = \overline{CNT/MSK} = \text{HIGH}$.

Switching Waveforms (continued)

Figure 12. Counter Reset [44, 45]



Notes

- 44. $\overline{CE}_0 = \overline{BE}_0 - \overline{BE}_3 = \text{LOW}$; $CE_1 = \overline{MRST} = \overline{CNT/MSK} = \text{HIGH}$.
- 45. No dead cycle exists during counter reset. A Read or Write cycle may be coincidental with the counter reset.
- 46. Retransmit happens if the counter remains in increment mode after it wraps to initially loaded value

Switching Waveforms (continued)

Figure 13. Readback State of Address Counter or Mask Register^[47, 48, 49, 50]



Notes

- 47. $\overline{CE_0} = \overline{OE} = \overline{BE_0} - \overline{BE_3} = \text{LOW}$; $\overline{CE_1} = \overline{R/\overline{W}} = \overline{\text{CNTRST}} = \overline{\text{MRST}} = \text{HIGH}$.
- 48. Address in output mode. Host must not be driving address bus after t_{CKLZ} in next clock cycle.
- 49. Address in input mode. Host can drive address bus after t_{CKHZ}.
- 50. A_n * is the internal value of the address counter (or the mask register depending on the CNT/MSK level) being Read out on the address lines.

Switching Waveforms (continued)

Figure 14. Left_Port (L_Port) Write to Right_Port (R_Port) Read^[51, 52, 53]

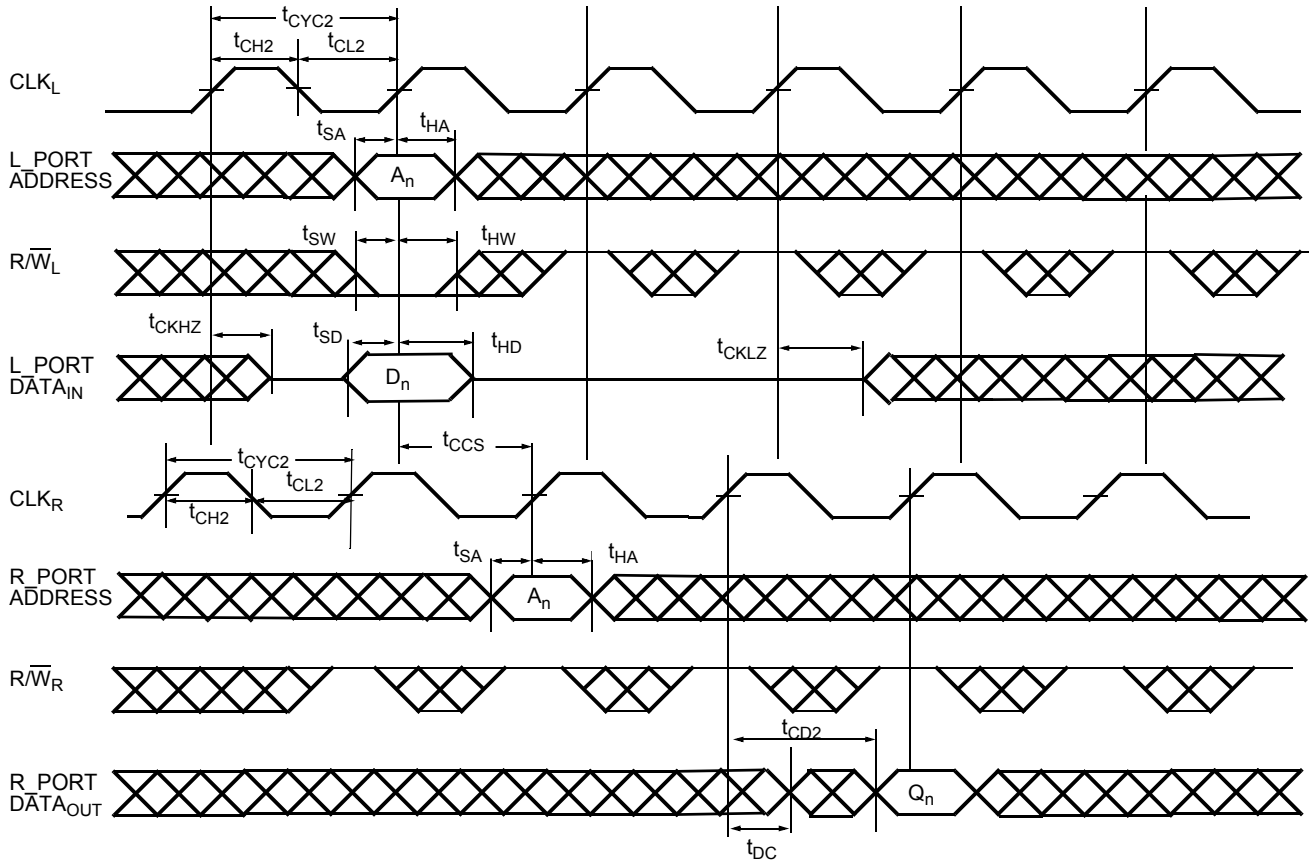

Notes

51. $\overline{CE}_0 = \overline{OE} = \overline{ADS} = \overline{CNTEN} = \overline{BE}_0 - \overline{BE}_3 = \text{LOW}$; $CE_1 = \overline{CNTRST} = \overline{MRST} = \overline{CNT/MSK} = \text{HIGH}$.

52. This timing is valid when one port is writing, and other port is reading the same location at the same time. If t_{CCS} is violated, indeterminate data is Read out.

53. If $t_{CCS} <$ minimum specified value, then R_Port Reads the most recent data (written by L_Port) only ($2 * t_{CYC2} + t_{CD2}$) after the rising edge of R_Port's clock. If $t_{CCS} \geq$ minimum specified value, then R_Port Reads the most recent data (written by L_Port) ($t_{CYC2} + t_{CD2}$) after the rising edge of R_Port's clock.

Switching Waveforms (continued)

Figure 15. Counter Interrupt and Retransmit^[54, 55, 56, 57, 58, 59]



Notes





- 54. X" = "Don't Care," "H" = HIGH, "L" = LOW.
- 55. Retransmit happens if the counter remains in increment mode after it wraps to initially loaded value.
- 56. $CE_0 = OE = BE0 - BE3 = LOW$; $CE_1 = R/W = CNTRST = MRST = HIGH$.
- 57. CNTINT is always driven.
- 58. CNTINT goes LOW when the unmasked portion of the address counter is incremented to the maximum value.
- 59. The mask register assumed to have the value of FFFFh.

Switching Waveforms (continued)

Figure 16. MailBox Interrupt Timing^[60, 61, 62, 63, 64]



Table 6. Read/Write and Enable Operation (Any Port)^[65, 66, 67, 68]

Inputs					Outputs	Operation
OE	CLK	CE ₀	CE ₁	R/W	DQ ₀ – DQ ₃₅	
X		H	X	X	High-Z	Deselected
X		X	L	X	High-Z	Deselected
X		L	H	L	D _{IN}	Write
L		L	H	H	D _{OUT}	Read
H	X	L	H	X	High-Z	Outputs disabled

Notes

- 60. CE₀ = OE = ADS = CNTEN = LOW; CE₁ = CNTRST = MRST = CNT/MSK = HIGH.
- 61. Address "FFFF" is the mailbox location for R_Port of this device.
- 62. L_Port is configured for Write operation, and R_Port is configured for Read operation.
- 63. At least one byte enable (BE₀ – BE₃) is required to be active during interrupt operations.
- 64. Interrupt flag is set with respect to the rising edge of the Write clock, and is reset with respect to the rising edge of the Read clock.
- 65. X" = "Don't Care," "H" = HIGH, "L" = LOW.
- 66. OE is an asynchronous input signal.
- 67. When CE changes state, deselection and Read happen after one cycle of latency.
- 68. CE₀ = OE = LOW; CE₁ = R/W = HIGH.

Ordering Information

64 K × 36 (2-Mbit) 3.3 V Synchronous CYD02S36V Dual-Port SRAM

Speed (MHz)	Ordering Code	Package Name	Package Type	Operating Range
167	CYD02S36VA-167BBC	BB256	256-ball BGA	Commercial
	CYD02S36VA-167BBXC		256-ball BGA Pb-free	

Ordering Code Definitions



Package Diagram

Figure 17. 256-ball FBGA (17 × 17 × 1.7 mm) Package Outline, 51-85108



51-85108 *1

REFERENCE JEDEC MO-192 PACKAGE WEIGHT - 0.95gr

Acronyms

Acronym	Description
BGA	Ball Grid Array
CMOS	Complementary Metal Oxide Semiconductor
FBGA	Fine-Pitch Ball Grid Array
I/O	Input/Output
JTAG	Joint Test Action Group
SRAM	Static Random Access Memory

Document Conventions

Units of Measure

Symbol	Unit of Measure
°C	degree Celsius
MHz	megahertz
μA	microampere
mA	milliampere
ns	nanosecond
Ω	ohm
pF	picofarad
V	volt
W	watt

Document History Page

Document Title: CYD02S36V/36VA, FLEEx36™ 3.3 V (64 K × 36) Synchronous Dual-Port RAM Document Number: 38-06076				
Rev.	ECN No.	Orig. of Change	Submission Date	Description of Change
**	232012	WWZ	See ECN	New data sheet
*A	244232	WWZ	See ECN	Changed pinout Changed FTSEL# to $\overline{\text{FTSEL}}$ in the block diagram
*B	313156	YDT	See ECN	Changed pinout D10 from NC to VSS to reflect test mode pin swap, C10 from rev[2,4] to VSS to reflect SC removal. Changed tRSCNTINT to tRSINT Added tRSINT to the master reset timing diagram Added CYD01S36V to data sheet Added I _{SB5} and changed I _{I_{X2}}
*C	321033	YDT	See ECN	Added CYD18S36V-133BBI to the Ordering Information Section
*D	327338	AEQ	See ECN	Change Pinout C10 from VSS to NC[2,5] Change Pinout G5 from VDDIO _L to REV _L [2,3]
*E	365315	YDT	See ECN	Added note for V _{CORE} Removed preliminary status
*F	2193427	NXR / AESA	See ECN	Changed t _{CD2} and t _{OE} Spec from 4ns to 4.4ns for -167. Template Update.
*G	2623658	VKN / PYRS	12/17/08	Added CYD02S36VA-15AXC part
*H	2899734	VKN	03/26/2010	Modified title on page 1 Removed 1M, 4M, 9M, and 18M densities and their related information Modified Logic block diagram and pin configuration Removed Industrial operating grade Removed 133 ns and 100ns speed bins Removed "BB256B" (23 x 23 x 1.7mm) 256-Ball FBGA package Updated Ordering Information table Updated "BB256" (17 x 17 x 1.7mm) 256-Ball FBGA package diagram
*I	3110296	ADMU	12/14/2010	Updated Ordering Information . Added Ordering Code Definitions .
*J	3202287	ADMU	03/22/2011	Updated as per template Updated notes Added Acronyms and Units of Measure table.
*K	3843734	SMCH	12/17/2012	Updated Ordering Information : Added CYD02S36VA-167BBXC part. Updated Package Diagram : spec 51-85108 - Changed revision from *H to *I.
*L	4336717	ADMU	04/08/2014	Updated in new template.
*M	4581625	ADMU	11/27/2014	Added related documentation hyperlink in page 1.

Sales, Solutions, and Legal Information

Worldwide Sales and Design Support

Cypress maintains a worldwide network of offices, solution centers, manufacturer's representatives, and distributors. To find the office closest to you, visit us at [Cypress Locations](#).

Products

Automotive	cypress.com/go/automotive
Clocks & Buffers	cypress.com/go/clocks
Interface	cypress.com/go/interface
Lighting & Power Control	cypress.com/go/powerpsoc cypress.com/go/plc
Memory	cypress.com/go/memory
PSoC	cypress.com/go/psoc
Touch Sensing	cypress.com/go/touch
USB Controllers	cypress.com/go/USB
Wireless/RF	cypress.com/go/wireless

PSoC[®] Solutions

[psoc.cypress.com/solutions](#)
[PSoC 1](#) | [PSoC 3](#) | [PSoC 4](#) | [PSoC 5LP](#)

Cypress Developer Community

[Community](#) | [Forums](#) | [Blogs](#) | [Video](#) | [Training](#)

Technical Support

[cypress.com/go/support](#)

© Cypress Semiconductor Corporation, 2004-2014. The information contained herein is subject to change without notice. Cypress Semiconductor Corporation assumes no responsibility for the use of any circuitry other than circuitry embodied in a Cypress product. Nor does it convey or imply any license under patent or other rights. Cypress products are not warranted nor intended to be used for medical, life support, life saving, critical control or safety applications, unless pursuant to an express written agreement with Cypress. Furthermore, Cypress does not authorize its products for use as critical components in life-support systems where a malfunction or failure may reasonably be expected to result in significant injury to the user. The inclusion of Cypress products in life-support systems application implies that the manufacturer assumes all risk of such use and in doing so indemnifies Cypress against all charges.

Any Source Code (software and/or firmware) is owned by Cypress Semiconductor Corporation (Cypress) and is protected by and subject to worldwide patent protection (United States and foreign), United States copyright laws and international treaty provisions. Cypress hereby grants to licensee a personal, non-exclusive, non-transferable license to copy, use, modify, create derivative works of, and compile the Cypress Source Code and derivative works for the sole purpose of creating custom software and or firmware in support of licensee product to be used only in conjunction with a Cypress integrated circuit as specified in the applicable agreement. Any reproduction, modification, translation, compilation, or representation of this Source Code except as specified above is prohibited without the express written permission of Cypress.

Disclaimer: CYPRESS MAKES NO WARRANTY OF ANY KIND, EXPRESS OR IMPLIED, WITH REGARD TO THIS MATERIAL, INCLUDING, BUT NOT LIMITED TO, THE IMPLIED WARRANTIES OF MERCHANTABILITY AND FITNESS FOR A PARTICULAR PURPOSE. Cypress reserves the right to make changes without further notice to the materials described herein. Cypress does not assume any liability arising out of the application or use of any product or circuit described herein. Cypress does not authorize its products for use as critical components in life-support systems where a malfunction or failure may reasonably be expected to result in significant injury to the user. The inclusion of Cypress' product in a life-support systems application implies that the manufacturer assumes all risk of such use and in doing so indemnifies Cypress against all charges.

Use may be limited by and subject to the applicable Cypress software license agreement.



Компания «ЭлектроПласт» предлагает заключение долгосрочных отношений при поставках импортных электронных компонентов на взаимовыгодных условиях!

Наши преимущества:

- Оперативные поставки широкого спектра электронных компонентов отечественного и импортного производства напрямую от производителей и с крупнейших мировых складов;
- Поставка более 17-ти миллионов наименований электронных компонентов;
- Поставка сложных, дефицитных, либо снятых с производства позиций;
- Оперативные сроки поставки под заказ (от 5 рабочих дней);
- Экспресс доставка в любую точку России;
- Техническая поддержка проекта, помощь в подборе аналогов, поставка прототипов;
- Система менеджмента качества сертифицирована по Международному стандарту ISO 9001;
- Лицензия ФСБ на осуществление работ с использованием сведений, составляющих государственную тайну;
- Поставка специализированных компонентов (Xilinx, Altera, Analog Devices, Intersil, Interpoint, Microsemi, Aeroflex, Peregrine, Syfer, Eurofarad, Texas Instrument, Miteq, Cobham, E2V, MA-COM, Hittite, Mini-Circuits, General Dynamics и др.);

Помимо этого, одним из направлений компании «ЭлектроПласт» является направление «Источники питания». Мы предлагаем Вам помощь Конструкторского отдела:

- Подбор оптимального решения, техническое обоснование при выборе компонента;
- Подбор аналогов;
- Консультации по применению компонента;
- Поставка образцов и прототипов;
- Техническая поддержка проекта;
- Защита от снятия компонента с производства.



Как с нами связаться

Телефон: 8 (812) 309 58 32 (многоканальный)

Факс: 8 (812) 320-02-42

Электронная почта: org@eplast1.ru

Адрес: 198099, г. Санкт-Петербург, ул. Калинина, дом 2, корпус 4, литера А.