



Micro Commercial Components



Micro Commercial Components
20736 Marilla Street Chatsworth
CA 91311
Phone: (818) 701-4933
Fax: (818) 701-4939

US2A THRU US2M

Features

- Halogen free available upon request by adding suffix "-HF"
- Glass Passivated Chip
- Super Fast Switching For High Efficiency
- Low Forward Voltage Drop And High Current Capability
- Low Reverse Leakage Current
- Lead Free Finish/Rohs Compliant (Note1) ("P" Suffix designates Compliant. See ordering information)
- Epoxy meets UL 94 V-0 flammability rating
- Moisture Sensitivity Level 1

Maximum Ratings

- Operating Temperature: -50°C to +150°C
- Storage Temperature: -50°C to +150°C
- Maximum Thermal Resistance; 20°C/W Junction To Lead

MCC Catalog Number	Device Marking	Maximum Recurrent Peak Reverse Voltage	Maximum RMS Voltage	Maximum DC Blocking Voltage
US2A	US2A	50V	35V	50V
US2B	US2B	100V	70V	100V
US2C	US2C	150V	105V	150V
US2D	US2D	200V	140V	200V
US2G	US2G	400V	280V	400V
US2J	US2J	600V	420V	600V
US2K	US2K	800V	560V	800V
US2M	US2M	1000V	700V	1000V

2 Amp Ultra Fast Rectifier 50 to 1000 Volts

DO-214AA (SMB) (Lead Frame)

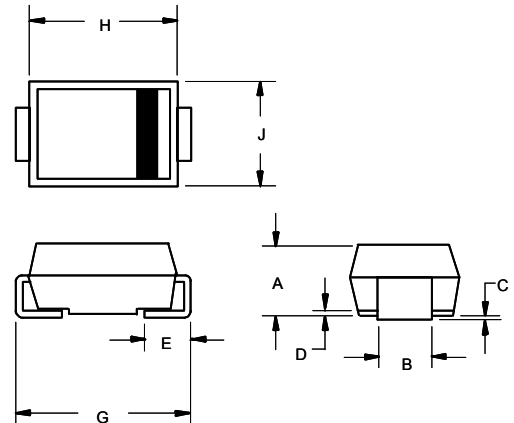

Electrical Characteristics @ 25°C Unless Otherwise Specified

Parameter	Symbol	Value	Conditions
Average Forward Current	$I_{F(AV)}$	2.0A	$T_L = 110^\circ\text{C}$
Peak Forward Surge Current	I_{FSM}	50A	8.3ms, half sine
Maximum Instantaneous Forward Voltage	V_F	1.0V 1.4V 1.65V	$I_{FM} = 2.0\text{A};$ $T_J = 25^\circ\text{C}$
Maximum DC Reverse Current At Rated DC Blocking Voltage	I_R	5 μA 200 μA (Max) 16 μA (Typ.)	$T_J = 25^\circ\text{C}$ $T_J = 125^\circ\text{C}$
Maximum Reverse Recovery Time	T_{rr}	50ns 75ns	$I_F=0.5\text{A}, I_R=1.0\text{A},$ $I_{rr}=0.25\text{A}$
Typical Junction Capacitance	C_J	28pF	Measured at 1.0MHz, $V_R=4.0\text{V}$

DIM	INCHES		MM		NOTE
	MIN	MAX	MIN	MAX	
A	.075	.095	1.91	2.41	
B	.077	.083	1.96	2.10	
C	.002	.008	.05	.20	
D	---	.02	---	.51	
E	.030	.060	.76	1.52	
G	.200	.220	5.08	5.59	
H	.160	.187	4.06	4.75	
J	.130	.155	3.30	3.94	

SUGGESTED SOLDER PAD LAYOUT

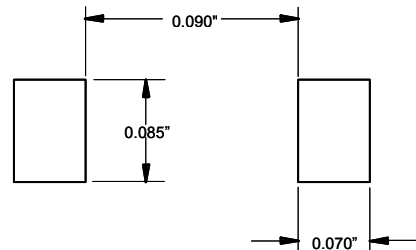

*Pulse test: Pulse width 300 μsec , Duty cycle 1%
Note:1. High Temperature Solder Exemptions Applied, see EU Directive Annex 7a.

US2A thru US2M

Figure 1
Typical Forward Characteristics

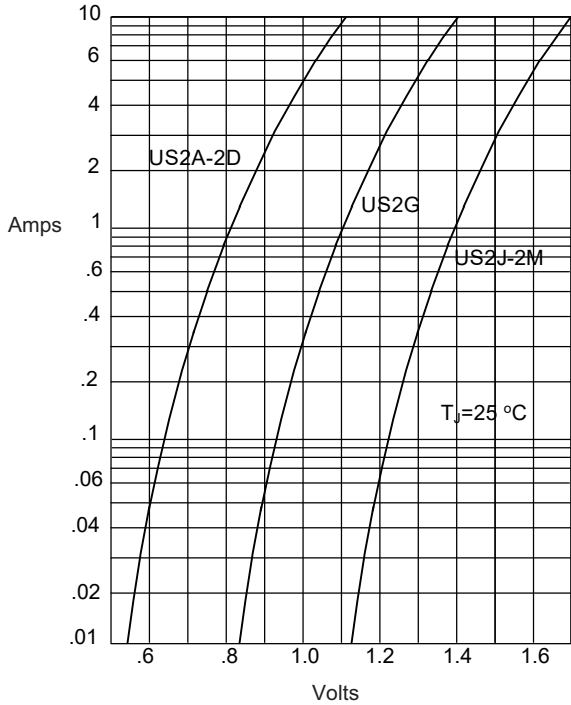

Instantaneous Forward Current - Amperes versus
Instantaneous Forward Voltage - Volts

Figure 2
Forward Derating Curve

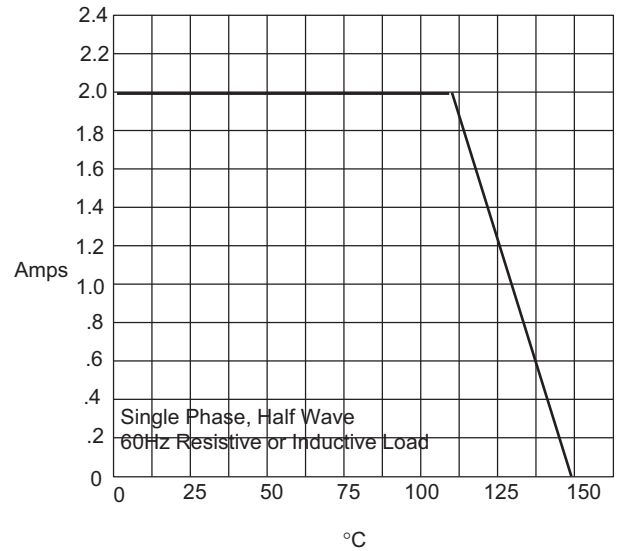

Average Forward Rectified Current - Amperes versus
Lead Temperature - $^\circ\text{C}$

Figure 3
Junction Capacitance

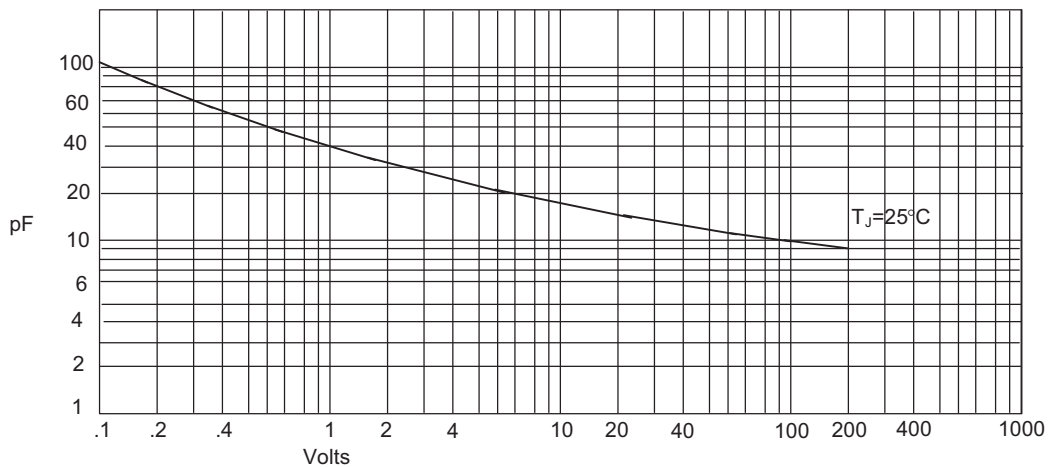

Junction Capacitance - pF versus
Reverse Voltage - Volts

US2A thru US2M

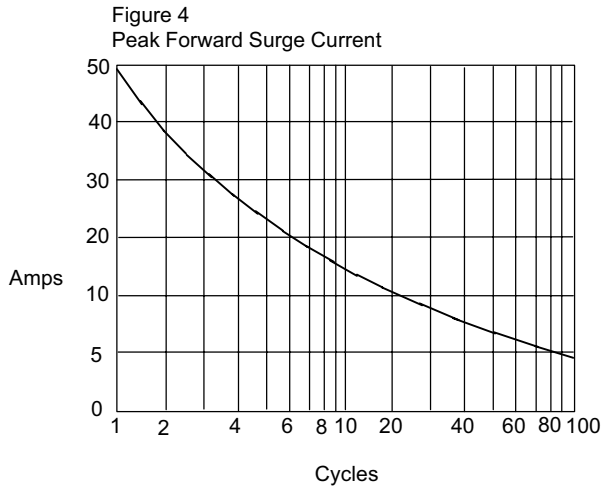

Peak Forward Surge Current - Amperes versus
Number Of Cycles At 60Hz - Cycles

Figure 5
Reverse Recovery Time Characteristic And Test Circuit Diagram

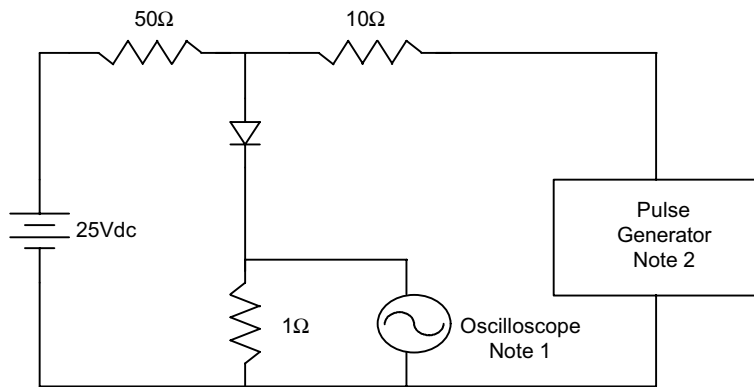

- Notes:
1. Rise Time = 7ns max.
Input impedance = 1 megohm, 22pF
 2. Rise Time = 10ns max.
Source impedance = 50 ohms
 3. Resistors are non-inductive

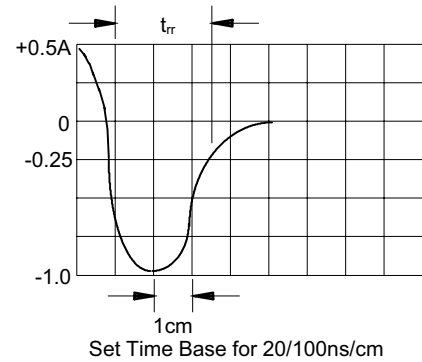



Micro Commercial Components

Ordering Information :

Device	Packing
Part Number-TP	Tape&Reel: 3Kpcs/Reel

Note : Adding "-HF" suffix for halogen free, eg. Part Number-TP-HF

*****IMPORTANT NOTICE*****

Micro Commercial Components Corp. reserves the right to make changes without further notice to any product herein to make corrections, modifications , enhancements , improvements , or other changes . **Micro Commercial Components Corp .** does not assume any liability arising out of the application or use of any product described herein; neither does it convey any license under its patent rights ,nor the rights of others . The user of products in such applications shall assume all risks of such use and will agree to hold **Micro Commercial Components Corp .** and all the companies whose products are represented on our website, harmless against all damages.

*****LIFE SUPPORT*****

MCC's products are not authorized for use as critical components in life support devices or systems without the express written approval of Micro Commercial Components Corporation.

*****CUSTOMER AWARENESS*****

Counterfeiting of semiconductor parts is a growing problem in the industry. Micro Commercial Components (MCC) is taking strong measures to protect ourselves and our customers from the proliferation of counterfeit parts. MCC strongly encourages customers to purchase MCC parts either directly from MCC or from Authorized MCC Distributors who are listed by country on our web page cited below. Products customers buy either from MCC directly or from Authorized MCC Distributors are genuine parts, have full traceability, meet MCC's quality standards for handling and storage. **MCC will not provide any warranty coverage or other assistance for parts bought from Unauthorized Sources.** MCC is committed to combat this global problem and encourage our customers to do their part in stopping this practice by buying direct or from authorized distributors.



Компания «ЭлектроПласт» предлагает заключение долгосрочных отношений при поставках импортных электронных компонентов на взаимовыгодных условиях!

Наши преимущества:

- Оперативные поставки широкого спектра электронных компонентов отечественного и импортного производства напрямую от производителей и с крупнейших мировых складов;
- Поставка более 17-ти миллионов наименований электронных компонентов;
- Поставка сложных, дефицитных, либо снятых с производства позиций;
- Оперативные сроки поставки под заказ (от 5 рабочих дней);
- Экспресс доставка в любую точку России;
- Техническая поддержка проекта, помощь в подборе аналогов, поставка прототипов;
- Система менеджмента качества сертифицирована по Международному стандарту ISO 9001;
- Лицензия ФСБ на осуществление работ с использованием сведений, составляющих государственную тайну;
- Поставка специализированных компонентов (Xilinx, Altera, Analog Devices, Intersil, Interpoint, Microsemi, Aeroflex, Peregrine, Syfer, Eurofarad, Texas Instrument, Miteq, Cobham, E2V, MA-COM, Hittite, Mini-Circuits, General Dynamics и др.);

Помимо этого, одним из направлений компании «ЭлектроПласт» является направление «Источники питания». Мы предлагаем Вам помощь Конструкторского отдела:

- Подбор оптимального решения, техническое обоснование при выборе компонента;
- Подбор аналогов;
- Консультации по применению компонента;
- Поставка образцов и прототипов;
- Техническая поддержка проекта;
- Защита от снятия компонента с производства.



Как с нами связаться

Телефон: 8 (812) 309 58 32 (многоканальный)

Факс: 8 (812) 320-02-42

Электронная почта: org@eplast1.ru

Адрес: 198099, г. Санкт-Петербург, ул. Калинина, дом 2, корпус 4, литера А.