

## Features

- Absolute encoder / absolute code output
- Digital output
- Sturdy construction
- Bushing mount
- Available with PC board mounting bracket (optional)
- \*RoHS compliant

## EAW - Absolute Contacting Encoder (ACE™)

### General Information

Until now, the choice of an absolute encoder meant an expensive, and larger-sized product. Through the use of combinatorial mathematics, the absolute code pattern of the Bourns® Absolute Contacting Encoder (ACE™) is placed on a single track for a very economical, energy-efficient and compact product. Bourns® ACE™ provides an absolute digital output that will also retain its last position in the event of a power failure.

An intelligent alternative to incremental encoders and potentiometers, the Bourns® ACE™ is ideally suited for many industrial, automotive, medical and consumer product applications.

### Recommended Control Diagram for ACE-128

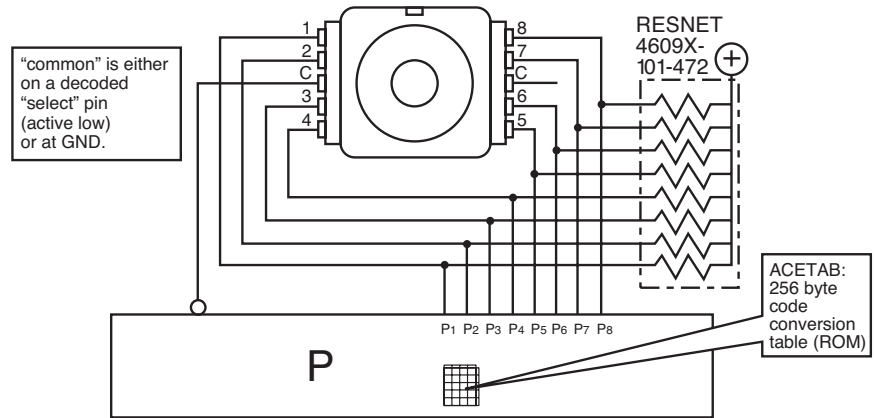

### Electrical Characteristics

|  |  |
|--|--|
| Output.....  | 8-bit code with 128 absolute states      |
| Closed Circuit Resistance .....  | 5 ohms maximum                           |
| Open Circuit Resistance.....   | 100 K ohms minimum                       |
| Contact Rating.....  | 10 milliamp @ 10 VDC or 0.1 watt maximum |
| Insulation Resistance (500 VDC) .....                                      | 1,000 megohms minimum                    |
| Dielectric Withstanding Voltage (MIL-STD-202 Method 301)<br>Sea Level..... | 1,000 VAC minimum                        |
| Electrical Travel .....  | Continuous                               |
| Contact Bounce (60 RPM).....   | 2.7 milliseconds maximum*                |
| RPM (Operating) .....  | 120 maximum                              |

### Environmental Characteristics

|                                  |                                       |
|----------------------------------|---------------------------------------|
| Operating Temperature Range..... | -40 °C to +85 °C (-40 °F to +185 °F)  |
| Storage Temperature Range .....  | -40 °C to +85 °C (-40 °F to +185 °F)  |
| Humidity.....                    | MIL-STD-202, Method 103B, Condition B |
| Vibration .....                  | 15 G                                  |
| Contact Bounce .....             | 0.1 millisecond maximum               |
| Shock.....                       | 50 G                                  |
| Contact Bounce .....             | 0.1 millisecond maximum               |
| Rotational Life.....             | 50,000 shaft revolutions minimum      |
| IP Rating.....                   | IP 40                                 |

### Mechanical Characteristics

|                               |   |
|-------------------------------|---|
| Mechanical Angle .....        | 360 ° Continuous  |
| Running Torque .....          | 0.5 to 1.5 N-cm (0.75 to 2.50 oz-in.)   |
| Mounting Torque.....          | 79 N-cm (7 lb.-in.) maximum   |
| Shaft Side Load (Static)..... | 4.5 kg (10 lbs.) minimum  |
| Weight .....                  | Approximately 14 gms. (0.50 oz.)  |
| Terminals .....               | Printed circuit board terminals   |
| Soldering Condition           |   |
| Manual Soldering.....         | 96.5Sn/3.0Ag/0.5Cu solid wire or no-clean rosin cored wire<br>370 °C (700 °F) max. for 3 seconds          |
| Wave Soldering .....          | 96.5Sn/3.0Ag/0.5Cu solder with no-clean flux<br>260 °C (500 °F) max. for 5 seconds                        |
| Wash processes .....          | Not recommended   |
| Marking.....                  | Manufacturer's name and trademark, part number, and date code.  |
| Hardware.....                 | One lockwasher and one mounting nut are shipped with each encoder, except where noted in the part number. |
| Packaging.....                | 45 pcs./tray  |

\*High probability of missing quadrature codes with maximum bounce.

\*RoHS Directive 2002/95/EC Jan. 27, 2003 including annex and RoHS Recast 2011/65/EU June 8, 2011.  
Specifications are subject to change without notice.  
Customers should verify actual device performance in their specific applications.

# EAW - Absolute Contacting Encoder (ACE™)

# BOURNS®

## Pin Output Code For ACE-128

Bit/Pin correlation: b7 b6 b5 b4 b3 b2 b1 b0 = p8 p7 p6 p5 p4 p3 p2 p1  
 A binary "1" denotes an "open" switch and a binary "0" denotes a "closed" switch.  
 Positions 0-127 are seen by a clockwise rotation of the shaft.

| Position | p8 | p7 | p6 | p5 | p4 | p3 | p2 | p1 | Decimal Output |
|----------|----|----|----|----|----|----|----|----|----------------|
| 0        | 0  | 1  | 1  | 1  | 1  | 1  | 1  | 1  | 127            |
| 1        | 0  | 0  | 1  | 1  | 1  | 1  | 1  | 1  | 63             |
| 2        | 0  | 0  | 1  | 1  | 1  | 1  | 1  | 0  | 62             |
| 3        | 0  | 0  | 1  | 1  | 1  | 0  | 1  | 0  | 58             |
| 4        | 0  | 0  | 1  | 1  | 1  | 0  | 0  | 0  | 56             |
| 5        | 1  | 0  | 1  | 1  | 1  | 0  | 0  | 0  | 184            |
| 6        | 1  | 0  | 0  | 1  | 1  | 0  | 0  | 0  | 152            |
| 7        | 0  | 0  | 0  | 1  | 1  | 0  | 0  | 0  | 24             |
| 8        | 0  | 0  | 0  | 0  | 1  | 0  | 0  | 0  | 8              |
| 9        | 0  | 1  | 0  | 0  | 1  | 0  | 0  | 0  | 72             |
| 10       | 0  | 1  | 0  | 0  | 1  | 0  | 0  | 1  | 73             |
| 11       | 0  | 1  | 0  | 0  | 1  | 1  | 0  | 1  | 77             |
| 12       | 0  | 1  | 0  | 0  | 1  | 1  | 1  | 1  | 79             |
| 13       | 0  | 0  | 0  | 0  | 1  | 1  | 1  | 1  | 15             |
| 14       | 0  | 0  | 1  | 0  | 1  | 1  | 1  | 1  | 47             |
| 15       | 1  | 0  | 1  | 0  | 1  | 1  | 1  | 1  | 175            |
| 16       | 1  | 0  | 1  | 1  | 1  | 1  | 1  | 1  | 191            |
| 17       | 1  | 0  | 0  | 1  | 1  | 1  | 1  | 1  | 159            |
| 18       | 0  | 0  | 0  | 1  | 1  | 1  | 1  | 1  | 31             |
| 19       | 0  | 0  | 0  | 1  | 1  | 1  | 0  | 1  | 29             |
| 20       | 0  | 0  | 0  | 1  | 1  | 1  | 0  | 0  | 28             |
| 21       | 0  | 1  | 0  | 1  | 1  | 1  | 0  | 0  | 92             |
| 22       | 0  | 1  | 0  | 0  | 1  | 1  | 0  | 0  | 76             |
| 23       | 0  | 0  | 0  | 0  | 1  | 1  | 0  | 0  | 12             |
| 24       | 0  | 0  | 0  | 0  | 0  | 1  | 0  | 0  | 4              |
| 25       | 0  | 0  | 1  | 0  | 0  | 1  | 0  | 0  | 36             |
| 26       | 1  | 0  | 1  | 0  | 0  | 1  | 0  | 0  | 164            |
| 27       | 1  | 0  | 1  | 0  | 0  | 1  | 1  | 0  | 166            |
| 28       | 1  | 0  | 1  | 0  | 0  | 1  | 1  | 1  | 167            |
| 29       | 1  | 0  | 0  | 0  | 0  | 1  | 1  | 1  | 135            |
| 30       | 1  | 0  | 0  | 1  | 0  | 1  | 1  | 1  | 151            |
| 31       | 1  | 1  | 0  | 1  | 0  | 1  | 1  | 1  | 215            |
| 32       | 1  | 1  | 0  | 1  | 1  | 1  | 1  | 1  | 223            |
| 33       | 1  | 1  | 0  | 0  | 1  | 1  | 1  | 1  | 207            |
| 34       | 1  | 1  | 0  | 0  | 1  | 1  | 1  | 1  | 143            |
| 35       | 1  | 0  | 0  | 0  | 1  | 1  | 1  | 0  | 142            |
| 36       | 0  | 0  | 0  | 0  | 1  | 1  | 1  | 0  | 14             |
| 37       | 0  | 0  | 1  | 0  | 1  | 1  | 1  | 0  | 46             |
| 38       | 0  | 0  | 1  | 0  | 0  | 1  | 1  | 0  | 38             |
| 39       | 0  | 0  | 0  | 0  | 0  | 1  | 1  | 0  | 6              |
| 40       | 0  | 0  | 0  | 0  | 0  | 0  | 1  | 0  | 2              |
| 41       | 0  | 0  | 0  | 1  | 0  | 0  | 1  | 0  | 18             |
| 42       | 0  | 1  | 0  | 1  | 0  | 0  | 1  | 0  | 82             |
| 43       | 0  | 1  | 0  | 1  | 0  | 0  | 1  | 1  | 83             |
| 44       | 1  | 1  | 0  | 1  | 0  | 0  | 1  | 1  | 211            |
| 45       | 1  | 1  | 0  | 0  | 0  | 0  | 1  | 1  | 195            |
| 46       | 1  | 1  | 0  | 0  | 1  | 0  | 1  | 1  | 203            |
| 47       | 1  | 1  | 1  | 0  | 1  | 0  | 1  | 1  | 235            |
| 48       | 1  | 1  | 1  | 0  | 1  | 1  | 1  | 1  | 239            |
| 49       | 1  | 1  | 1  | 0  | 0  | 1  | 1  | 1  | 231            |
| 50       | 1  | 1  | 0  | 0  | 0  | 1  | 1  | 1  | 199            |
| 51       | 0  | 1  | 0  | 0  | 0  | 1  | 1  | 1  | 71             |
| 52       | 0  | 0  | 0  | 0  | 0  | 1  | 1  | 1  | 7              |
| 53       | 0  | 0  | 0  | 1  | 0  | 1  | 1  | 1  | 23             |
| 54       | 0  | 0  | 0  | 1  | 0  | 0  | 1  | 1  | 19             |
| 55       | 0  | 0  | 0  | 0  | 0  | 0  | 1  | 1  | 3              |
| 56       | 0  | 0  | 0  | 0  | 0  | 0  | 0  | 1  | 1              |
| 57       | 0  | 0  | 0  | 0  | 1  | 0  | 0  | 1  | 9              |
| 58       | 0  | 0  | 1  | 0  | 1  | 0  | 0  | 1  | 41             |
| 59       | 1  | 0  | 1  | 0  | 1  | 0  | 0  | 1  | 169            |
| 60       | 1  | 1  | 1  | 0  | 1  | 0  | 0  | 1  | 233            |
| 61       | 1  | 1  | 1  | 0  | 0  | 0  | 0  | 1  | 225            |
| 62       | 1  | 1  | 1  | 0  | 0  | 1  | 0  | 1  | 229            |
| 63       | 1  | 1  | 1  | 1  | 0  | 1  | 0  | 1  | 245            |

| Position | p8 | p7 | p6 | p5 | p4 | p3 | p2 | p1 | Decimal Output |
|----------|----|----|----|----|----|----|----|----|----------------|
| 64       | 1  | 1  | 1  | 1  | 0  | 1  | 1  | 1  | 247            |
| 65       | 1  | 1  | 1  | 1  | 0  | 0  | 1  | 1  | 243            |
| 66       | 1  | 1  | 1  | 1  | 0  | 0  | 0  | 1  | 227            |
| 67       | 1  | 0  | 1  | 0  | 0  | 0  | 1  | 1  | 163            |
| 68       | 1  | 0  | 0  | 0  | 0  | 0  | 1  | 1  | 131            |
| 69       | 1  | 0  | 0  | 0  | 1  | 0  | 1  | 1  | 139            |
| 70       | 1  | 0  | 0  | 0  | 1  | 0  | 0  | 1  | 137            |
| 71       | 1  | 0  | 0  | 0  | 0  | 0  | 0  | 1  | 129            |
| 72       | 1  | 0  | 0  | 0  | 0  | 0  | 0  | 0  | 128            |
| 73       | 1  | 0  | 0  | 0  | 0  | 1  | 0  | 0  | 132            |
| 74       | 1  | 0  | 0  | 1  | 0  | 1  | 0  | 0  | 148            |
| 75       | 1  | 1  | 0  | 1  | 0  | 1  | 0  | 0  | 212            |
| 76       | 1  | 1  | 1  | 1  | 0  | 1  | 0  | 0  | 244            |
| 77       | 1  | 1  | 1  | 1  | 0  | 0  | 0  | 0  | 240            |
| 78       | 1  | 1  | 1  | 1  | 0  | 0  | 1  | 0  | 242            |
| 79       | 1  | 1  | 1  | 1  | 1  | 0  | 1  | 0  | 250            |
| 80       | 1  | 1  | 1  | 1  | 1  | 0  | 1  | 1  | 251            |
| 81       | 1  | 1  | 1  | 1  | 1  | 0  | 0  | 1  | 249            |
| 82       | 1  | 1  | 1  | 1  | 0  | 0  | 0  | 1  | 241            |
| 83       | 1  | 1  | 0  | 1  | 0  | 0  | 0  | 1  | 209            |
| 84       | 1  | 1  | 0  | 0  | 0  | 0  | 0  | 1  | 193            |
| 85       | 1  | 1  | 0  | 0  | 0  | 1  | 0  | 1  | 197            |
| 86       | 1  | 1  | 0  | 0  | 0  | 1  | 0  | 0  | 196            |
| 87       | 1  | 1  | 0  | 0  | 0  | 0  | 0  | 0  | 192            |
| 88       | 0  | 1  | 0  | 0  | 0  | 0  | 0  | 0  | 64             |
| 89       | 0  | 1  | 0  | 0  | 0  | 0  | 1  | 0  | 66             |
| 90       | 0  | 1  | 0  | 0  | 1  | 0  | 1  | 0  | 74             |
| 91       | 0  | 1  | 1  | 0  | 1  | 0  | 1  | 0  | 106            |
| 92       | 0  | 1  | 1  | 1  | 1  | 0  | 1  | 0  | 122            |
| 93       | 0  | 1  | 1  | 1  | 1  | 0  | 0  | 0  | 120            |
| 94       | 0  | 1  | 1  | 1  | 1  | 0  | 0  | 1  | 121            |
| 95       | 0  | 1  | 1  | 1  | 1  | 1  | 0  | 1  | 125            |
| 96       | 1  | 1  | 1  | 1  | 1  | 1  | 0  | 1  | 253            |
| 97       | 1  | 1  | 1  | 1  | 1  | 1  | 0  | 0  | 252            |
| 98       | 1  | 1  | 1  | 1  | 1  | 0  | 0  | 0  | 248            |
| 99       | 1  | 1  | 1  | 0  | 1  | 0  | 0  | 0  | 232            |
| 100      | 1  | 1  | 1  | 0  | 0  | 0  | 0  | 0  | 224            |
| 101      | 1  | 1  | 1  | 0  | 0  | 0  | 1  | 0  | 226            |
| 102      | 0  | 1  | 1  | 0  | 0  | 0  | 1  | 0  | 98             |
| 103      | 0  | 1  | 1  | 0  | 0  | 0  | 0  | 0  | 96             |
| 104      | 0  | 0  | 1  | 0  | 0  | 0  | 0  | 0  | 32             |
| 105      | 0  | 0  | 1  | 0  | 0  | 0  | 0  | 1  | 33             |
| 106      | 0  | 0  | 1  | 0  | 0  | 1  | 0  | 1  | 37             |
| 107      | 0  | 0  | 1  | 1  | 0  | 1  | 0  | 1  | 53             |
| 108      | 0  | 0  | 1  | 1  | 1  | 1  | 0  | 1  | 61             |
| 109      | 0  | 0  | 1  | 1  | 1  | 1  | 0  | 0  | 60             |
| 110      | 1  | 0  | 1  | 1  | 1  | 1  | 0  | 0  | 188            |
| 111      | 1  | 0  | 1  | 1  | 1  | 1  | 1  | 0  | 190            |
| 112      | 1  | 1  | 1  | 1  | 1  | 1  | 1  | 0  | 254            |
| 113      | 0  | 1  | 1  | 1  | 1  | 1  | 1  | 0  | 126            |
| 114      | 0  | 1  | 1  | 1  | 1  | 1  | 0  | 0  | 124            |
| 115      | 0  | 1  | 1  | 1  | 0  | 1  | 0  | 0  | 116            |
| 116      | 0  | 1  | 1  | 1  | 0  | 0  | 0  | 0  | 112            |
| 117      | 0  | 1  | 1  | 1  | 0  | 0  | 0  | 1  | 113            |
| 118      | 0  | 0  | 1  | 1  | 0  | 0  | 0  | 1  | 49             |
| 119      | 0  | 0  | 1  | 1  | 0  | 0  | 0  | 0  | 48             |
| 120      | 0  | 0  | 0  | 1  | 0  | 0  | 0  | 0  | 16             |
| 121      | 1  | 0  | 0  | 1  | 0  | 0  | 0  | 0  | 144            |
| 122      | 1  | 0  | 0  | 1  | 0  | 0  | 1  | 0  | 146            |
| 123      | 1  | 0  | 0  | 1  | 1  | 0  | 1  | 0  | 154            |
| 124      | 1  | 0  | 0  | 1  | 1  | 1  | 1  | 0  | 158            |
| 125      | 0  | 0  | 0  | 1  | 1  | 1  | 1  | 0  | 30             |
| 126      | 0  | 1  | 0  | 1  | 1  | 1  | 1  | 0  | 94             |
| 127      | 0  | 1  | 0  | 1  | 1  | 1  | 1  | 1  | 95             |

# EAW - Absolute Contacting Encoder (ACE™)

**BOURNS®**

## Dimensional Drawings

### Bushing Mounted: Housing A with Rear Facing Terminals

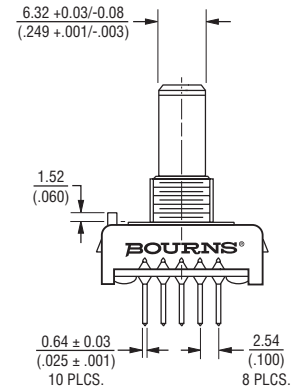
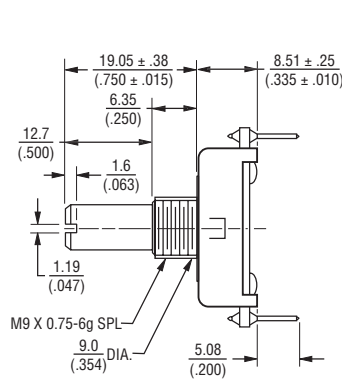
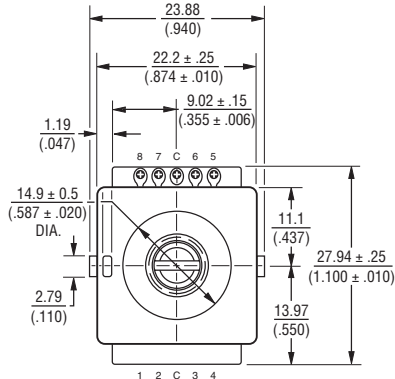

### Bushing Mounted: Housing A with Forward Facing Terminals

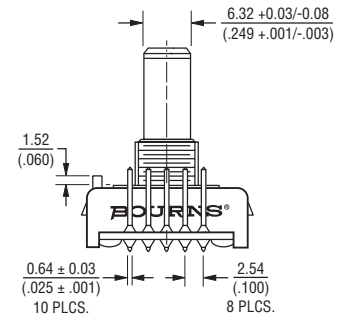
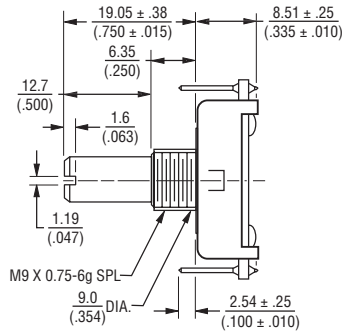
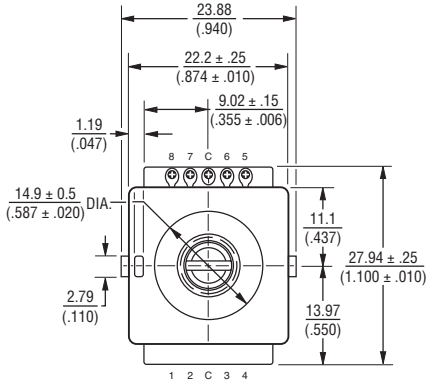

### PCB Bracket Mounted: Housing B

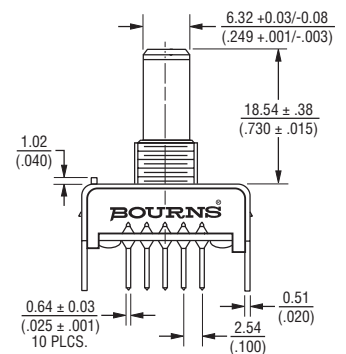
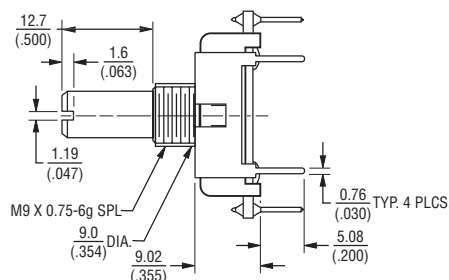
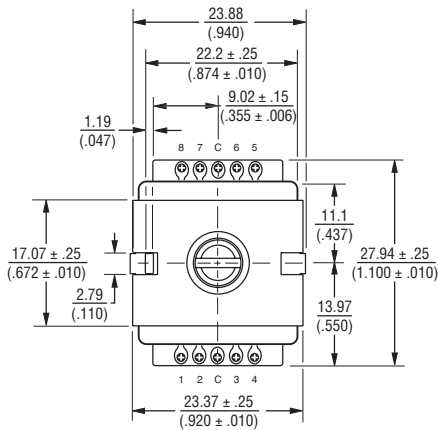

Specifications are subject to change without notice.  
Customers should verify actual device performance in their specific applications.

# EAW - Absolute Contacting Encoder (ACE™)

# BOURNS®

## Dimensional Drawings

Shaft Style B

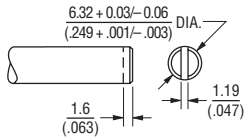

Shaft Style C

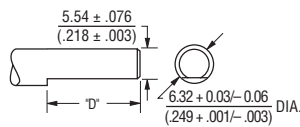

\*D\* DIMENSION EXTENDS FROM SHAFT END TO BUSHING FACE  
 \*D\* = (SHAFT LENGTH, FMS) - (BUSHING LENGTH)

Shaft Style R

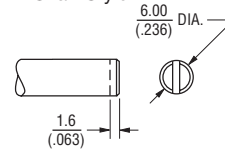

Bushing Mounted: Housing A with Rear Facing Terminals

Panel Hole Dimensions

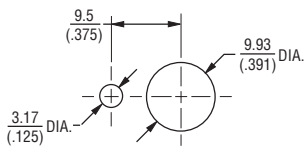

PCB Board Hole Pattern w/PCB Bracket

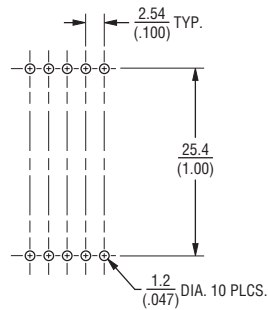

Bushing Mounted: Housing A with Forward Facing Terminals

PCB Board Hole Pattern w/PCB Bracket

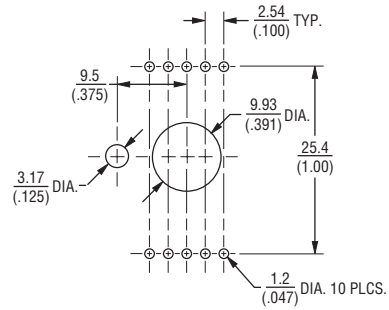

PCB Bracket Mounted: Housing B

Panel Hole Dimensions

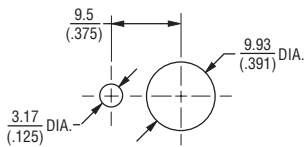

PCB Board Hole Pattern w/PCB Bracket

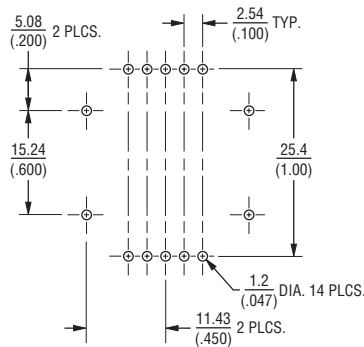

TOLERANCES EXCEPT WHERE NOTED:

.XX = ± .51 (.02)    .XXX = ± .127 (.005)

DIMENSIONS:  $\frac{MM}{(IN)}$

# EAW - Absolute Contacting Encoder (ACE™)

# BOURNS®

## How to Order

### PART NUMBERING SYSTEM

**E A W 0 J - B 2 4 - A E 0 1 2 8 L**

| Code | Rotational Life    |
|------|--------------------|
| A    | 50,000 Revolutions |

| BUSHING CONFIGURATION |  |
|-----------------------|--|
| Code                  | Description  |
| W                     | 9 mm x 1/4 " Length. Threaded M9x0.75                        |
| L                     | 9 mm x 3/8 " Length. Threaded M9x0.75<br>(Use B shaft only.) |

| DETENT CONFIGURATION |              |
|----------------------|--------------|
| Code                 | Description  |
| 0                    | Non-Detented |

| ANTI-ROTATION LUG POSITION |               |
|----------------------------|---------------|
| Code                       | Description   |
| J                          | 9:00 Position |
| D                          | None          |

| SHAFT STYLE (See Outline Drawing for Details) |                                       |
|---|---------------------------------------|
| Code  | Description                           |
| B   | Plain with Inserted Slot (1/4 " Dia.) |
| C   | Single Flatted (1/4 " Dia.)           |
| R   | Plain with Inserted Slot (6 mm Dia.)  |

| RoHS IDENTIFIER |             |
|-----------------|-------------|
| Code            | Description |
| L               | Compliant   |

| PERFORMANCE CODE |         |             |
|------------------|---------|-------------|
| Code             | Detents | States/Rev. |
| E0128            | 0       | 128         |

| HOUSING TERMINAL CONFIGURATION<br>(X indicates "Equipped With") |   |   |   |   |   |
|---|---|---|---|---|---|
| Code  |   |   |   |   |   |
| Features  | A | B | C | H | K |
| Rear Mount Terminals  | X | X | X |   |   |
| Forward Facing Terminals  |   |   |   | X | X |
| PCB Bracket   |   | X | X |   |   |
| Hardware Included   | X |   | X | X |   |

| SHAFT LENGTH (FMS) |                         |                        |
|--------------------|-------------------------|------------------------|
| Code               | Description             | Available Shaft Styles |
| 24                 | 3/4 " (19.05 mm) Length | B, C                   |
| Metric             |                         |                        |
| 19                 | 19 mm Length            | R                      |

The sample part number demonstrates the identification code for Bourns contacting encoders. The part number shown is a commonly used model, typically available from stock.

\*Consult factory concerning special inquiries.

REV. 03/12

Specifications are subject to change without notice. Customers should verify actual device performance in their specific applications.



Компания «ЭлектроПласт» предлагает заключение долгосрочных отношений при поставках импортных электронных компонентов на взаимовыгодных условиях!

Наши преимущества:

- Оперативные поставки широкого спектра электронных компонентов отечественного и импортного производства напрямую от производителей и с крупнейших мировых складов;
- Поставка более 17-ти миллионов наименований электронных компонентов;
- Поставка сложных, дефицитных, либо снятых с производства позиций;
- Оперативные сроки поставки под заказ (от 5 рабочих дней);
- Экспресс доставка в любую точку России;
- Техническая поддержка проекта, помощь в подборе аналогов, поставка прототипов;
- Система менеджмента качества сертифицирована по Международному стандарту ISO 9001;
- Лицензия ФСБ на осуществление работ с использованием сведений, составляющих государственную тайну;
- Поставка специализированных компонентов (Xilinx, Altera, Analog Devices, Intersil, Interpoint, Microsemi, Aeroflex, Peregrine, Syfer, Eurofarad, Texas Instrument, Miteq, Cobham, E2V, MA-COM, Hittite, Mini-Circuits, General Dynamics и др.);

Помимо этого, одним из направлений компании «ЭлектроПласт» является направление «Источники питания». Мы предлагаем Вам помощь Конструкторского отдела:

- Подбор оптимального решения, техническое обоснование при выборе компонента;
- Подбор аналогов;
- Консультации по применению компонента;
- Поставка образцов и прототипов;
- Техническая поддержка проекта;
- Защита от снятия компонента с производства.



#### Как с нами связаться

**Телефон:** 8 (812) 309 58 32 (многоканальный)

**Факс:** 8 (812) 320-02-42

**Электронная почта:** [org@eplast1.ru](mailto:org@eplast1.ru)

**Адрес:** 198099, г. Санкт-Петербург, ул. Калинина, дом 2, корпус 4, литера А.