

100 mA Low Noise, High Ripple Rejection, Negative-voltage LDO Regulator

No. EA-379-181207

OVERVIEW

The RP117x is a negative voltage LDO regulator that provides high ripple rejection and low output noise. Adding only one capacitor to each input and output pin can make a simple structure and high performance LDO regulator.

KEY BENEFITS

- Provides high ripple rejection rate and low output noise, which is ideal for noise-sensitive devices.
- Requires only one capacitor for each input and output pin, and is available in small DFN(PLP)1212-6 and SC-88A packages, both of which can utilize the space on board.

KEY SPECIFICATIONS

- Input Voltage Range: -10.0 V to -2.5 V
- Output Voltage Range: -5.5 V to -1.0 V
- Output Current: 100 mA
- Supply Current: Typ. 75 μA
- Ripple Rejection Rate: Typ. 80 dB, $f = 1\text{ kHz}$
- Output Noise: Typ. 16 μVrms
($V_{\text{SET}} = -5.5\text{ V}$ to -2.0 V)
- Protection Features: Thermal Shutdown Protection
Short-circuit Protection
- Auto-discharge Function

TYPICAL APPLICATIONS

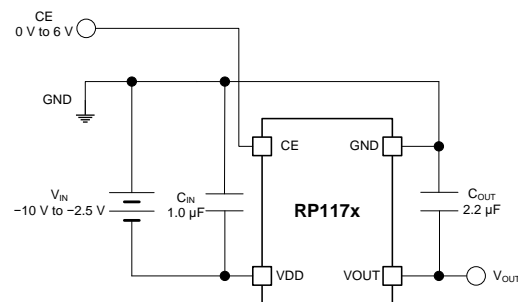

PACKAGE

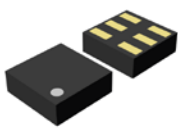

DFN(PLP)1212-6
1.20 x 1.20 x 0.4⁽¹⁾ (mm)
⁽¹⁾ maximum dimension

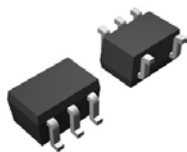

SC-88A
2.0 x 2.1 x 0.9 (mm)

SELECTION GUIDE

The set output voltage and the package type are user-selectable options.

Product Name	Package
RP117Kxx1D-TR	DFN(PLP)1212-6
RP117Qxx2D-TR-FE	SC-88A

xx: Specify the set output voltage (V_{SET}) within the range of -5.5 V to -1.0 V in 0.1 V steps.

APPLICATIONS

- Noise-sensitive Devices: Sensors, DACs, ADCs, Amplifiers
- Audio Devices, DSLRs
- Measuring Instruments
- Liquid Crystal Panels, Bias Power Supply for CCDs

RP117x

No. EA-379-181207

SELECTION GUIDE

The RP117x includes an auto-discharge function⁽¹⁾. A set output voltage and a package type are user-selectable options.

Selection Guide

Product Name	Package	Quantity per Real	Pb Free	Halogen Free
RP117Kxx1D-TR	DFN(PLP)1212-6	5,000 pcs	Yes	Yes
RP117Qxx2D-TR-FE	SC-88A	3,000 pcs	Yes	Yes

xx: Specify the set output voltage (V_{SET}) within the range of -5.5 V to -1.0 V in 0.1 V steps.

The voltage in 0.05 V step is shown as follows:

Ex. -1.35 V : RP117x13xx5

BLOCK DIAGRAM

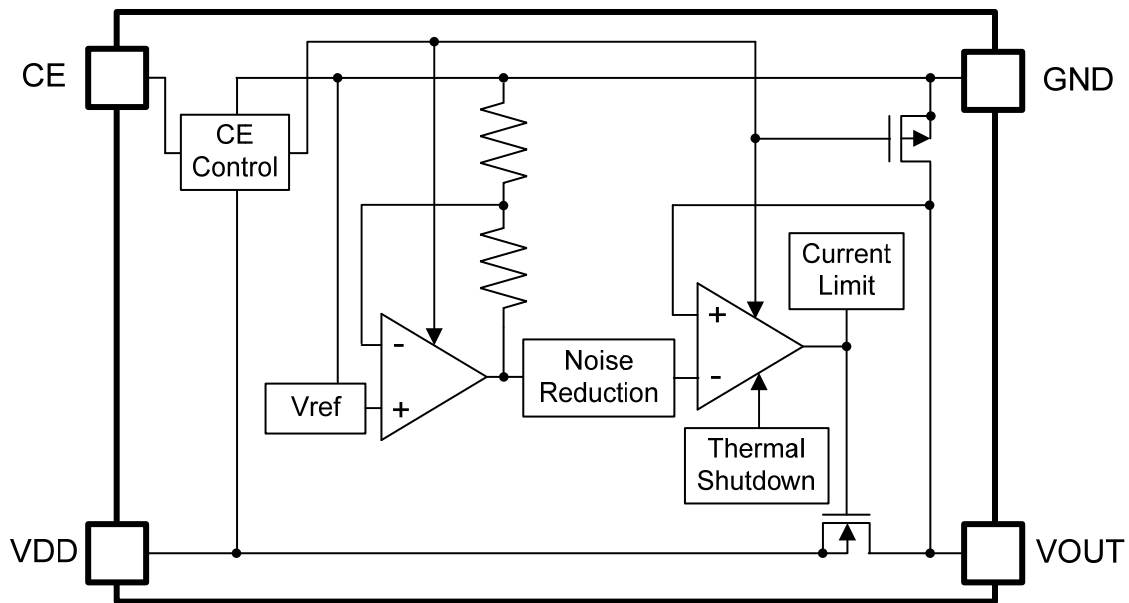

RP117x Block Diagram

⁽¹⁾ Auto-discharge function quickly lowers the output voltage to 0 V , when the chip enable signal is switched from the active mode to the standby mode, by releasing the electrical charge accumulated in the external capacitor.

PIN DESCRIPTIONS

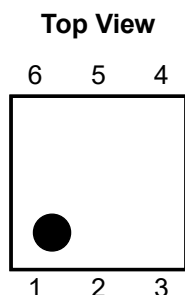

DFN(PLP)1212-6 Pin Configuration

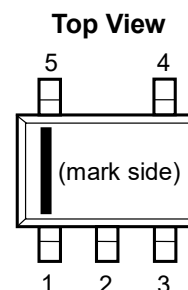
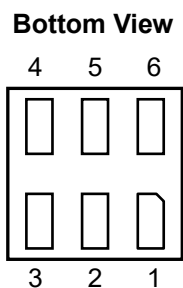

SC-88A Pin Configuration

DFN(PLP)1212-6 Pin Description

Pin No.	Symbol	Description
1	CE	Chip Enable Pin, Active-high
2	NC	No Connection
3	VDD	Input Pin
4	VOUT	Output Pin
5	NC	No Connection
6	GND	Ground Pin

SC-88A Pin Description

Pin No.	Symbol	Description
1	GND	Ground Pin
2	VDD	Input Pin
3	VOUT	Output Pin
4	CE	Chip Enable Pin, Active-high
5	NC	No Connection

RP117x

No. EA-379-181207

ABSOLUTE MAXIMUM RATINGS

Absolute Maximum Ratings

Symbol	Parameter		Rating	Unit
V _{IN}	Input Voltage		-11.0 to 0.3	V
V _{CE}	CE Pin Voltage		-0.3 to 7.0	V
V _{OUT}	VOUT Pin Voltage		V _{IN} - 0.3 to 0.3	V
I _{OUT}	Output Current		220	mA
P _D	Power Dissipation ⁽¹⁾	DFN(PLP)1212-6 (JEDEC STD.51)	450	mW
		SC-88A (Standard Test Land Pattern)	380	mW
T _j	Junction Temperature		-40 to 125	°C
T _{stg}	Storage Temperature Range		-55 to 125	°C

ABSOLUTE MAXIMUM RATINGS

Electronic and mechanical stress momentarily exceeded absolute maximum ratings may cause the permanent damages and may degrade the life time and safety for both device and system using the device in the field. The functional operation at or over these absolute maximum ratings is not assured.

RECOMMENDED OPERATING TEMPERATURE

Recommended Operating Conditions

Symbol	Parameter	Rating	Unit
V _{IN}	Input Voltage	-10.0 to -2.5	V
V _{CE}	CE Pin Voltage	0 to 6.0	V
T _a	Operating Temperature	-40 to 85	°C

RECOMMENDED OPERATING CONDITIONS

All of electronic equipment should be designed that the mounted semiconductor devices operate within the recommended operating conditions. The semiconductor devices cannot operate normally over the recommended operating conditions, even if when they are used over such conditions by momentary electronic noise or surge. And the semiconductor devices may receive serious damage when they continue to operate over the recommended operating conditions.

⁽¹⁾ Please refer to *POWER DISSIPATION* for detailed information.

ELECTRICAL CHARACTERISTICS

$V_{IN} = V_{SET} - 1.0\text{ V}$ ($V_{SET} > -1.5\text{ V}$, $V_{IN} = -2.5\text{ V}$), $I_{OUT} = 1\text{ mA}$, $C_{IN} = 1.0\text{ }\mu\text{F}$, $C_{OUT} = 2.2\text{ }\mu\text{F}$, unless otherwise noted.

The specifications surrounded by are guaranteed by design engineering at $-40^{\circ}\text{C} \leq T_a \leq 85^{\circ}\text{C}$.

RP117x Electrical Characteristics

($T_a = 25^{\circ}\text{C}$)

Symbol	Parameter	Test Conditions/Comments	Min.	Typ.	Max.	Unit
V_{OUT}	Output Voltage	$T_a = 25^{\circ}\text{C}$	x 1.020		x 0.980	V
		$-40^{\circ}\text{C} \leq T_a \leq 85^{\circ}\text{C}$	x 1.050		x 0.950	V
I_{OUT}	Output Current		100			mA
$\frac{\Delta V_{OUT}}{\Delta I_{OUT}}$	Load Regulation	$1\text{ mA} \leq I_{OUT} \leq 100\text{ mA}$		10	30	mV
V_{DIF}	Dropout Voltage	$I_{OUT} = 100\text{ mA}$	Refer to <i>PRODUCT-SPECIFIC ELECTRICAL CHARACTERISTICS</i>			
I_{SS}	Supply Current	$I_{OUT} = 0\text{ mA}$		75	150	μA
$I_{STANDBY}$	Standby Current	$V_{CE} = 0\text{ V}$		0.01	0.15	μA
$\frac{\Delta V_{OUT}}{\Delta V_{IN}}$	Line Regulation	$-10.0\text{ V} \leq V_{IN} \leq V_{SET} - 0.5\text{ V}$ (Up to -2.5 V)	-0.30		0.30	%/V
RR	Ripple Rejection	$f = 1\text{ kHz}$, Ripple 0.2 V_{p-p} , $V_{IN} = V_{SET} - 1.0\text{ V}$, $I_{OUT} = 30\text{ mA}$ ($V_{SET} \geq -2.5\text{ V}$, $V_{IN} = -3.5\text{ V}$)		80		dB
V_{IN}	Input Voltage		-10.0		-2.5	V
$\frac{\Delta V_{OUT}}{\Delta T_a}$	Output Voltage Temperature Coefficient	$-40^{\circ}\text{C} \leq T_a \leq 85^{\circ}\text{C}$		± 100		ppm/ $^{\circ}\text{C}$
I_{SC}	Short Current Limit	$V_{OUT} = 0\text{ V}$		150		mA
R_{CE}	CE Pull-down Resistance	$V_{IN} = -5\text{ V}$, $V_{CE} = 3\text{ V}$		5		M Ω
V_{CEH}	CE Pin Input Voltage, high		1.5			V
V_{CEL}	CE Pin Input Voltage, low				0.5	V
en	Output Noise	BW = 10 Hz to 100 kHz, $I_{OUT} = 30\text{ mA}$	$V_{SET} > -2.0\text{ V}$	44 - 13 x $ V_{SET} $		μV_{rms}
			$V_{SET} \leq -2.0\text{ V}$	16		
T_{TSD}	Thermal Shutdown Temperature Threshold, rising	Junction Temperature		165		$^{\circ}\text{C}$
T_{TSR}	Thermal Shutdown Temperature Threshold, falling	Junction Temperature		110		$^{\circ}\text{C}$
R_{LOW}	Auto-discharge PMOS On Resistance	$V_{IN} = -4.0\text{ V}$, $V_{CE} = 0\text{ V}$		250		Ω

All test items listed under *Electrical Characteristics* are done under the pulse load condition ($T_j \approx T_a = 25^{\circ}\text{C}$) except Output Voltage Temperature Coefficient, Output Noise and Ripple Rejection.

RP117x

No. EA-379-181207

ELECTRICAL CHARACTERISTICS (continued)

The specifications surrounded by are guaranteed by design engineering at $-40^{\circ}\text{C} \leq T_a \leq 85^{\circ}\text{C}$.

RP117x Product-specific Electrical Characteristics

Product Name	V _{OUT} [V]						V _{DIF} [V]	
	T _a = 25°C			-40°C ≤ T _a ≤ 85°C			Typ.	Max.
	Min.	Typ.	Max.	Min.	Typ.	Max.		
RP117x10xx	-1.020	-1.000	-0.980	-1.050	-1.000	-0.950	(1)	(1)
RP117x11xx	-1.122	-1.100	-1.078	-1.155	-1.100	-1.045		
RP117x12xx	-1.224	-1.200	-1.176	-1.260	-1.200	-1.140		
RP117x13xx	-1.326	-1.300	-1.274	-1.365	-1.300	-1.235		
RP117x13xx5	-1.377	-1.350	-1.323	-1.417	-1.350	-1.283		
RP117x14xx	-1.428	-1.400	-1.372	-1.470	-1.400	-1.330		
RP117x15xx	-1.530	-1.500	-1.470	-1.575	-1.500	-1.425	0.66 ⁽¹⁾	0.7
RP117x16xx	-1.632	-1.600	-1.568	-1.680	-1.600	-1.520		
RP117x17xx	-1.734	-1.700	-1.666	-1.785	-1.700	-1.615		
RP117x18xx	-1.836	-1.800	-1.764	-1.890	-1.800	-1.710		
RP117x19xx	-1.938	-1.900	-1.862	-1.995	-1.900	-1.805		
RP117x20xx	-2.040	-2.000	-1.960	-2.100	-2.000	-1.900		
RP117x21xx	-2.142	-2.100	-2.058	-2.205	-2.100	-1.995	0.31 ⁽¹⁾	0.45
RP117x22xx	-2.244	-2.200	-2.156	-2.310	-2.200	-2.090		
RP117x23xx	-2.346	-2.300	-2.254	-2.415	-2.300	-2.185		
RP117x24xx	-2.448	-2.400	-2.352	-2.520	-2.400	-2.280		
RP117x25xx	-2.550	-2.500	-2.450	-2.625	-2.500	-2.375		
RP117x26xx	-2.652	-2.600	-2.548	-2.730	-2.600	-2.470		
RP117x27xx	-2.754	-2.700	-2.646	-2.835	-2.700	-2.565		
RP117x28xx	-2.856	-2.800	-2.744	-2.940	-2.800	-2.660		
RP117x29xx	-2.958	-2.900	-2.842	-3.045	-2.900	-2.755		
RP117x30xx	-3.060	-3.000	-2.940	-3.150	-3.000	-2.850		
RP117x31xx	-3.162	-3.100	-3.038	-3.255	-3.100	-2.945	0.23	0.30
RP117x32xx	-3.264	-3.200	-3.136	-3.360	-3.200	-3.040		
RP117x33xx	-3.366	-3.300	-3.234	-3.465	-3.300	-3.135		
RP117x34xx	-3.468	-3.400	-3.332	-3.570	-3.400	-3.230		
RP117x35xx	-3.570	-3.500	-3.430	-3.675	-3.500	-3.325		
RP117x36xx	-3.672	-3.600	-3.528	-3.780	-3.600	-3.420		
RP117x37xx	-3.774	-3.700	-3.626	-3.885	-3.700	-3.515		
RP117x38xx	-3.876	-3.800	-3.724	-3.990	-3.800	-3.610		
RP117x39xx	-3.978	-3.900	-3.822	-4.095	-3.900	-3.705		
RP117x40xx	-4.080	-4.000	-3.920	-4.200	-4.000	-3.800		
RP117x41xx	-4.182	-4.100	-4.018	-4.305	-4.100	-3.895	0.13	0.21
RP117x42xx	-4.284	-4.200	-4.116	-4.410	-4.200	-3.990		
RP117x43xx	-4.386	-4.300	-4.214	-4.515	-4.300	-4.085		
RP117x44xx	-4.488	-4.400	-4.312	-4.620	-4.400	-4.180		
RP117x45xx	-4.590	-4.500	-4.410	-4.725	-4.500	-4.275		
RP117x46xx	-4.692	-4.600	-4.508	-4.830	-4.600	-4.370		
RP117x47xx	-4.794	-4.700	-4.606	-4.935	-4.700	-4.465		
RP117x48xx	-4.896	-4.800	-4.704	-5.040	-4.800	-4.560		
RP117x49xx	-4.998	-4.900	-4.802	-5.145	-4.900	-4.655		
RP117x50xx	-5.100	-5.000	-4.900	-5.250	-5.000	-4.750		
RP117x51xx	-5.202	-5.100	-4.998	-5.355	-5.100	-4.845		
RP117x52xx	-5.304	-5.200	-5.096	-5.460	-5.200	-4.940		
RP117x53xx	-5.406	-5.300	-5.194	-5.565	-5.300	-5.035		
RP117x54xx	-5.508	-5.400	-5.292	-5.670	-5.400	-5.130		
RP117x55xx	-5.610	-5.500	-5.390	-5.775	-5.500	-5.225		

⁽¹⁾ Input voltage should be equal or less than the maximum operating voltage (-2.5 V).

THEORY OF OPERATION

CE Pin Input Current

The CE pin input current is determined by the VDD pin input voltage and the CE pin input voltage as shown in the table below.

		CE Voltage[V]				
		1.5	2	3	4	5
V _{in} [V]	-2.5	0.3	0.3	0.4	0.5	0.6
	-3	0.3	0.4	0.5	0.5	0.6
	-4	0.4	0.4	0.5	0.6	0.7
	-5	0.5	0.5	0.6	0.7	0.8
	-6	0.5	0.6	0.7	0.7	0.8
	-7	0.6	0.6	0.7	0.8	0.9
	-8	0.7	0.7	0.8	0.9	1.0
	-9	0.7	0.8	0.9	1.0	1.0
	-10	0.8	0.8	0.9	1.0	1.1

(uA)

RP117x CE Pin Input Current

Minimum Operating Voltage

The RP 117x does not include an UVLO circuit. To make the internal circuit operate normally and to ensure good output regulation, V_{IN} has to be: $V_{IN} \leq V_{SET} - V_{DIF}$ (Max. -2.5 V). To bring out the best characteristics of the output noise voltage, the ripple rejection and the load transient response, V_{IN} has to be $V_{IN} = V_{SET} - 1.0$ V.

Thermal Shutdown

Thermal shutdown deactivates a circuit when the junction temperature exceeds the thermal shutdown threshold (T_{TSD}) of Typ. 165°C, and reactivates it when the junction temperature falls below the thermal shutdown release threshold (T_{TSR}) of Typ. 110°C. During the reactivation, the inrush current limit is in operation. Note that deactivation and activation cycle can be repeated due to load, heat dissipation and ambient temperature conditions. Thermal shutdown cannot be used for the purpose of heat sink, so the repetitive cycles of deactivation and activation may affect the reliability of the device.

RP117x

No. EA-379-181207

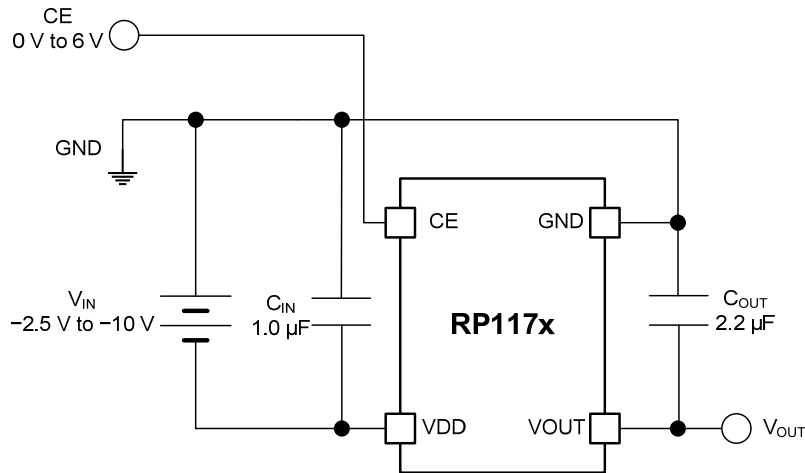
APPLICATION INFORMATION**RP117x Typical Application Circuit****External Components**

Symbol	Description
C _{IN}	Ceramic Capacitor, 1.0 μF, TDK, CGA3E1X7R1C105K
C _{OUT}	Ceramic Capacitor, 2.2 μF, TDK, CGA5L2X7R1E225K

Technical Notes on the Selection of External Components

- Phase compensation is provided to secure stable operation even when the load current is varied. For this purpose, use a 2.2-μF or more output capacitor (C_{OUT}) with good frequency characteristics and proper ESR (Equivalent Series Resistance). In case of using a tantalum type capacitor with a large ESR, the output might become unstable. Evaluate your circuit including consideration of frequency characteristics.
- The high impedance of the wirings may result in noise pickup and unstable operation of the device. Reduce the impedance of the VDD and GND wirings. Connect a 1.0-μF or more input capacitor (C_{IN}) between the VDD and GND pins with shortest-distance wiring. Also, connect a 2.2-μF or more output capacitor (C_{OUT}) between the VOUT and GND pins with shortest-distance wiring

TYPICAL CHARACTERISTICS

Note: Typical Characteristics are intended to be used as reference data; they are not guaranteed.

1) Output Voltage vs. Ambient Temperature (C_{IN} = Ceramic 1.0 μ F, C_{OUT} = Ceramic 2.2 μ F)

RP117x101x

$V_{IN} = -2.5$ V, $I_{OUT} = 1$ mA

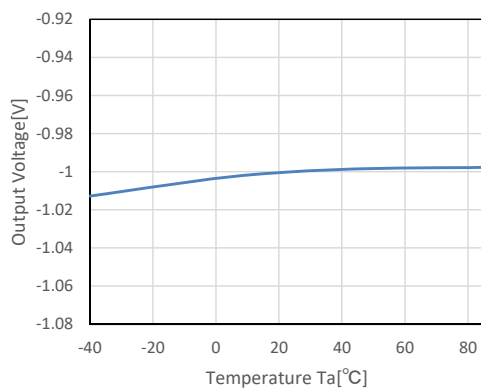

RP117x251x

$V_{IN} = -3.5$ V, $I_{OUT} = 1$ mA

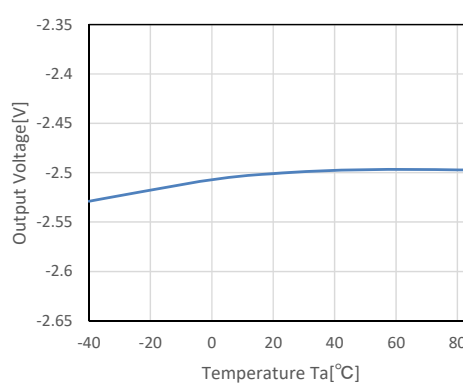

RP117x551x

$V_{IN} = -6.5$ V, $I_{OUT} = 1$ mA

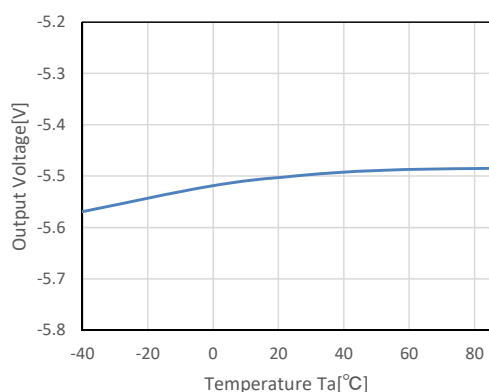

2) Supply Current vs. Ambient Temperature (C_{IN} = Ceramic 1.0 μ F, C_{OUT} = Ceramic 2.2 μ F)

RP117x101x

$V_{IN} = -2.5$ V

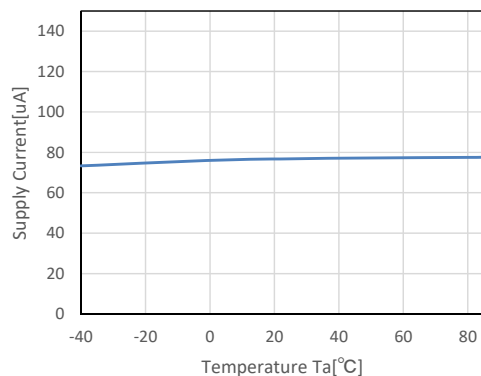

RP117x251x

$V_{IN} = -3.5$ V

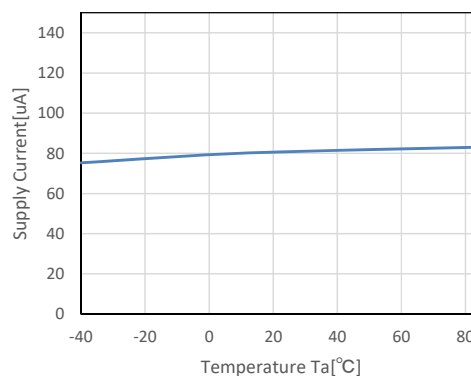

RP117x

No. EA-379-181207

RP117x551x

$V_{IN} = -6.5\text{ V}$

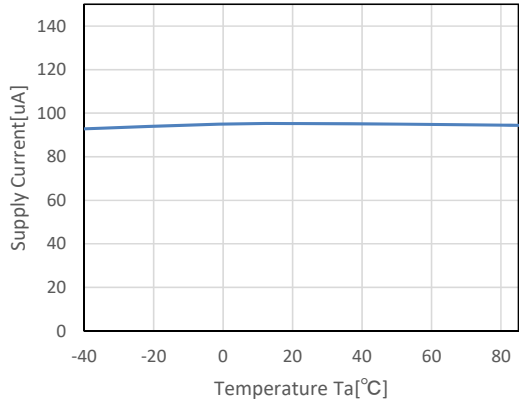

3) Dropout Voltage vs. Output Current ($C_{IN} = \text{Ceramic } 1.0\ \mu\text{F}$, $C_{OUT} = \text{Ceramic } 2.2\ \mu\text{F}$)

RP117x101x

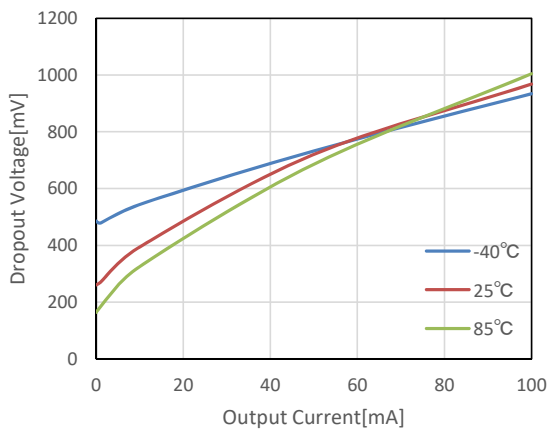

RP117x251x

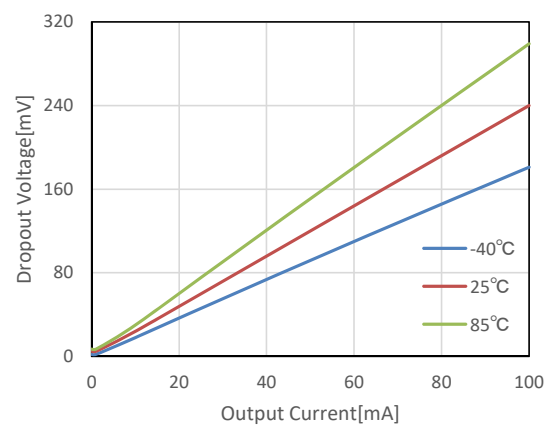

RP117x551x

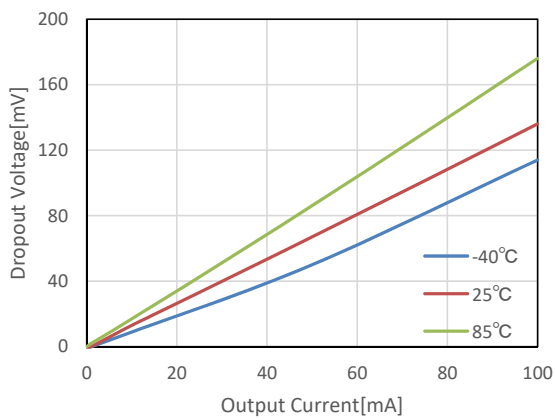

4) Dropout Voltage vs. Set Output Voltage (C_{IN} = Ceramic 1.0 μ F, C_{OUT} = Ceramic 2.2 μ F, T_a = 25°C)

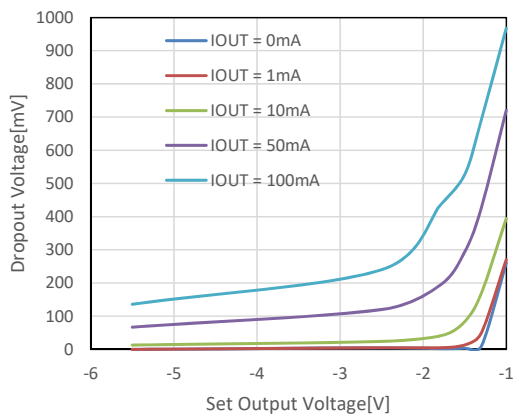

5) Output Voltage vs. Output Current (C_{IN} = Ceramic 1.0 μ F, C_{OUT} = Ceramic 2.2 μ F, T_a = 25°C)

RP117x101x

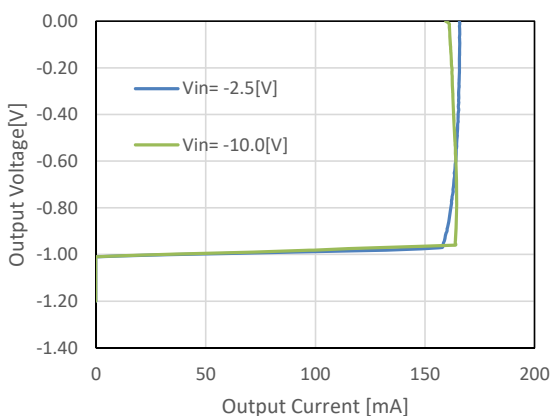

RP117x251x

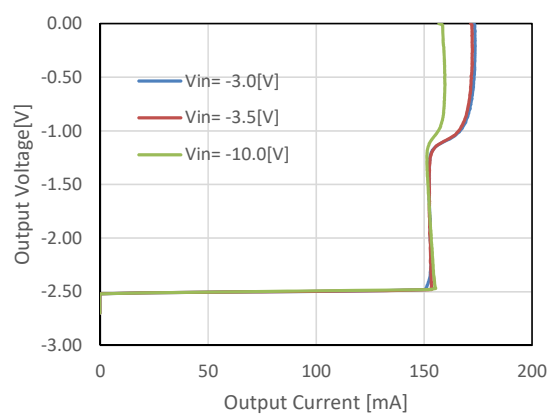

RP117x551x

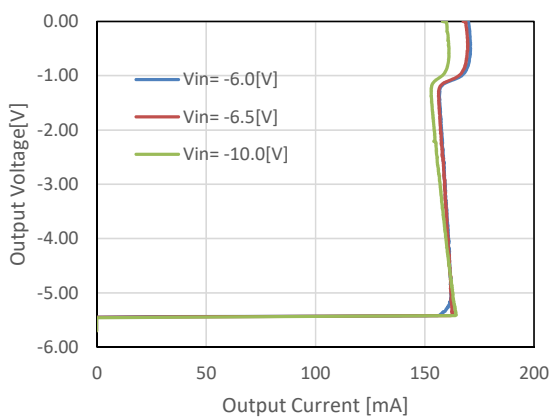

RP117x

No. EA-379-181207

6) Output Voltage vs. Input Voltage (C_{IN} = Ceramic 1.0 μ F, C_{OUT} = Ceramic 2.2 μ F, T_a = 25°C)

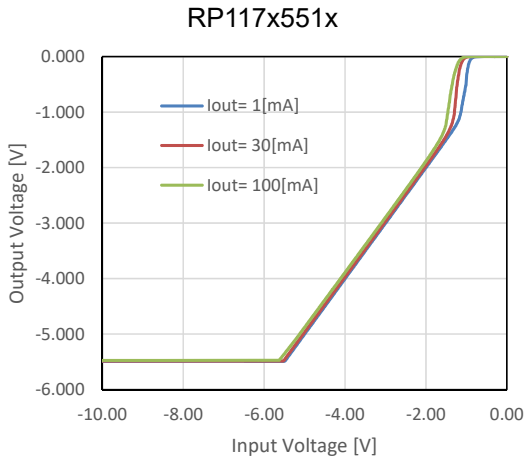
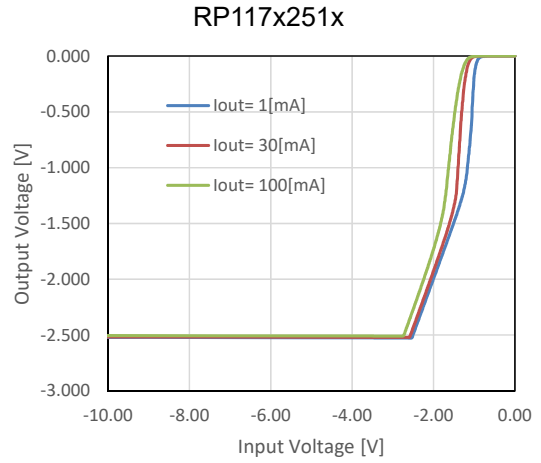
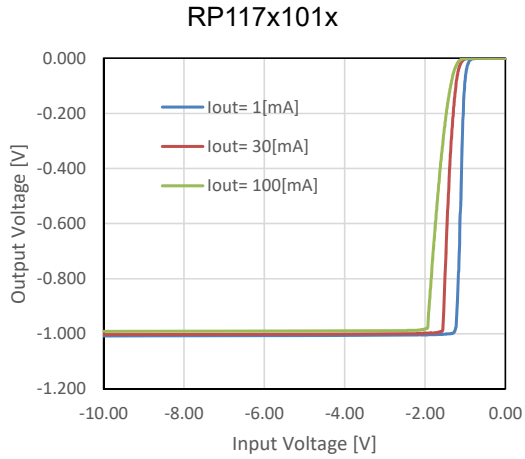

7) Supply Current vs. Input Voltage (C_{IN} = Ceramic 1.0 μ F, C_{OUT} = Ceramic 2.2 μ F, T_a = 25°C)

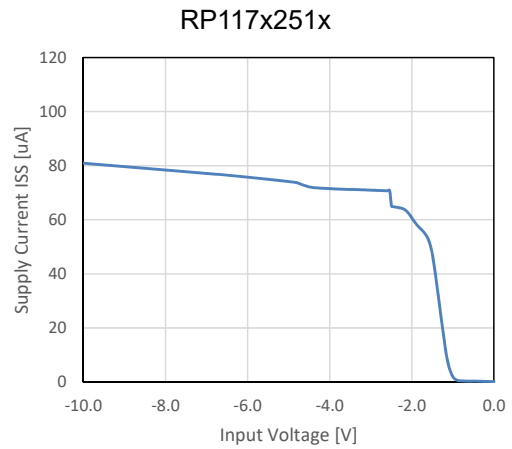
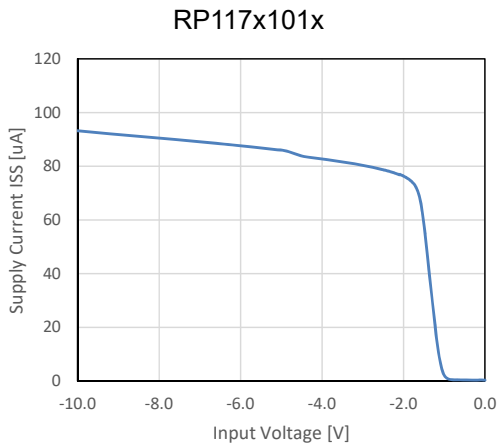

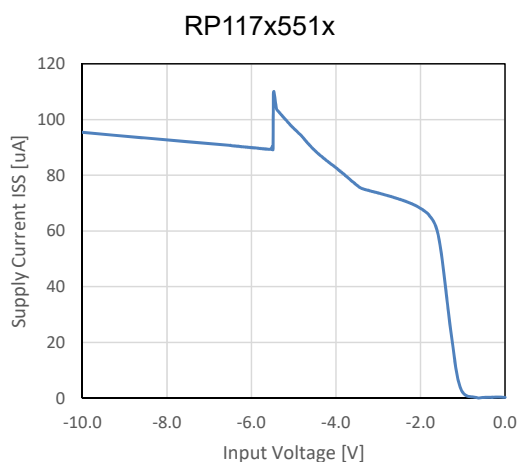

8) Ripple Rejection vs. Frequency (C_{IN} = none, C_{OUT} = Ceramic 2.2 μ F, Ripple = 0.2 Vp-p, T_a = 25°C)

RP117x101x

$V_{IN} = -3.5$ V

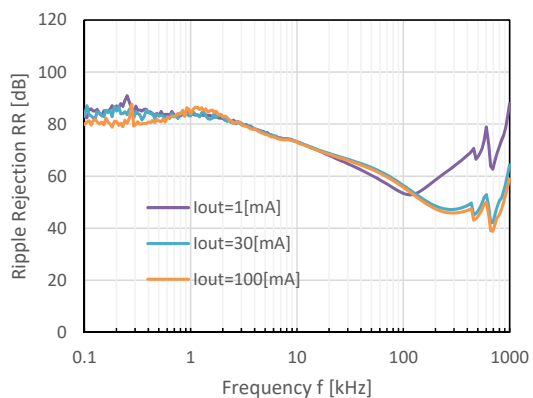

RP117x251x

$V_{IN} = -3.5$ V

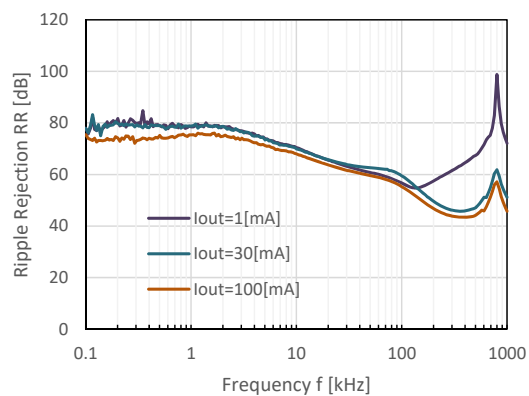

RP117x551x

$V_{IN} = -6.5$ V

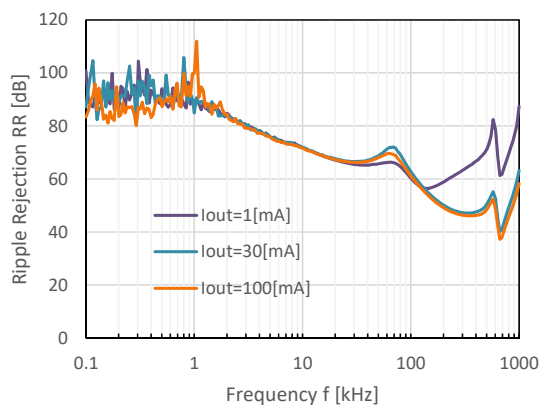

RP117x

No. EA-379-181207

9) Ripple Rejection vs. Input Voltage (C_{IN} = none, C_{OUT} = Ceramic 2.2 μ F, Ripple = 0.2 Vp-p, T_a = 25°C)

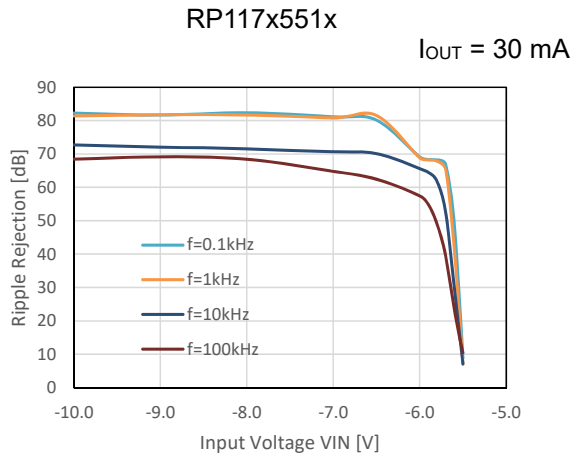
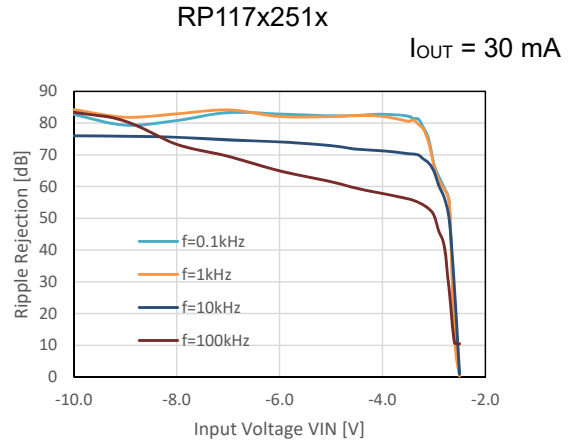
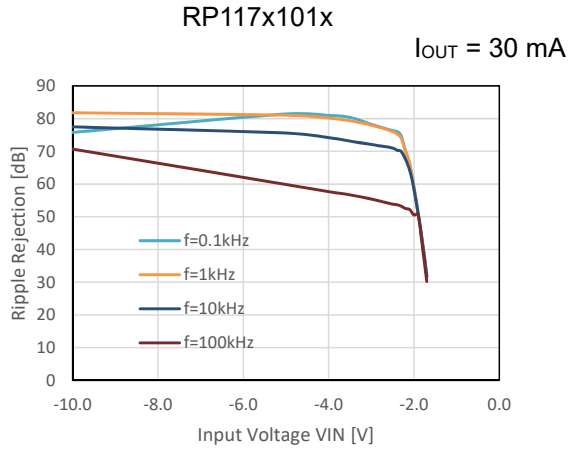

10) Output Noise vs. Ambient Temperature (C_{IN} = Ceramic 1.0 μ F, C_{OUT} = Ceramic 2.2 μ F)

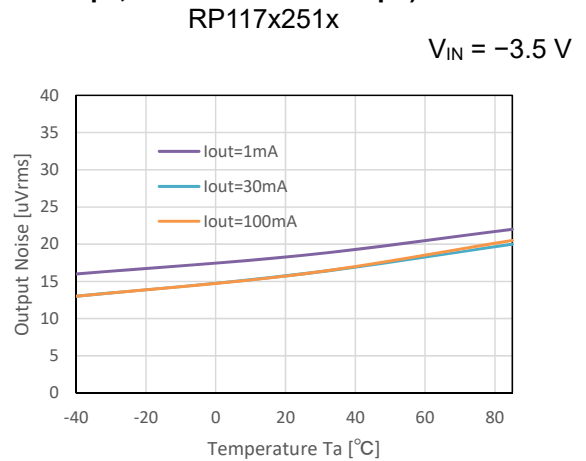
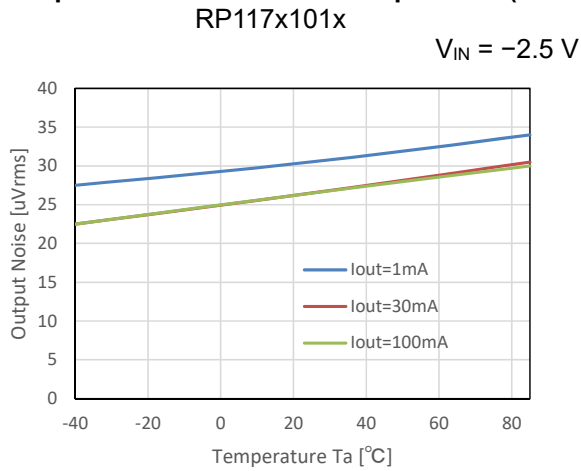

RP117x551x

$V_{IN} = -6.5\text{ V}$

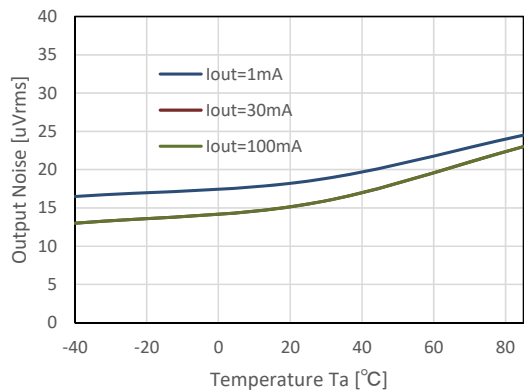

11) Output Noise vs. Frequency ($C_{IN} = \text{Ceramic } 1.0\ \mu\text{F}$, $C_{OUT} = \text{Ceramic } 2.2\ \mu\text{F}$, $T_a = 25^\circ\text{C}$)

RP117x101x

$V_{IN} = -2.5\text{ V}$

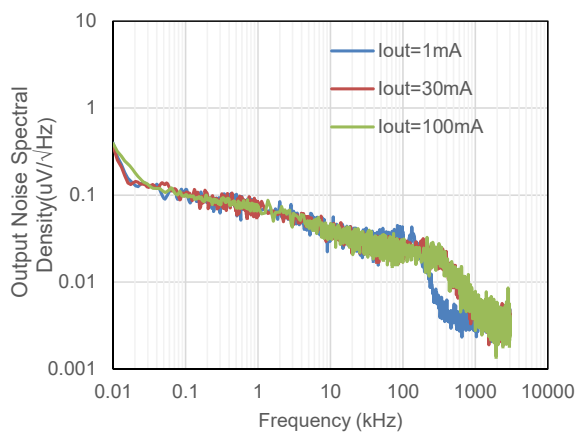

RP117x251x

$V_{IN} = -3.5\text{ V}$

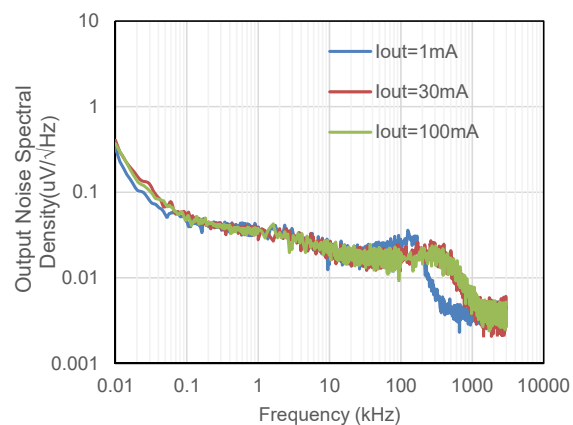

RP117x551x

$V_{IN} = -6.5\text{ V}$

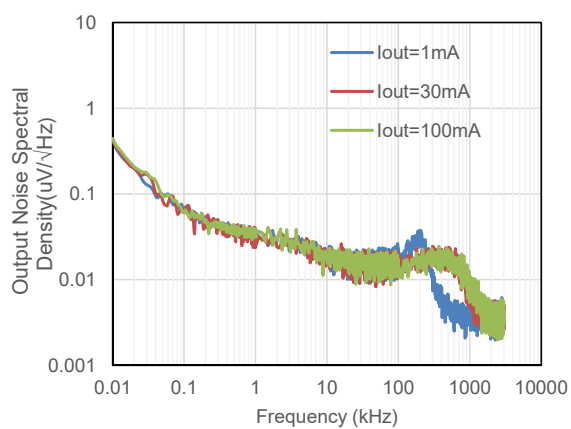

RP117x

No. EA-379-181207

12) Input Transient Response ($C_{IN} = \text{Ceramic } 1.0 \mu\text{F}$, $C_{OUT} = \text{Ceramic } 2.2 \mu\text{F}$, $t_r = t_f = 10 \mu\text{s}$, $T_a = 25^\circ\text{C}$)

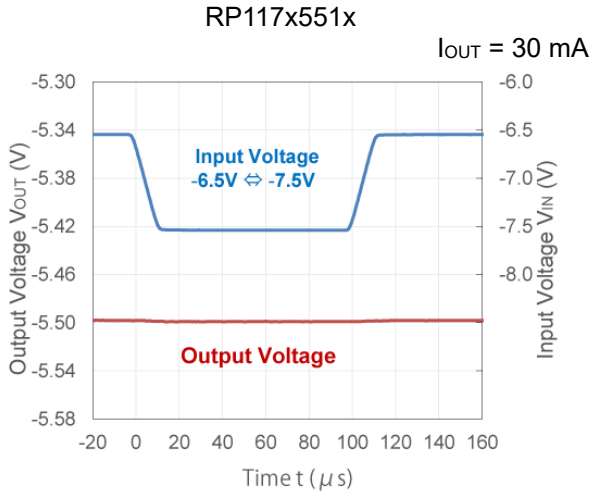
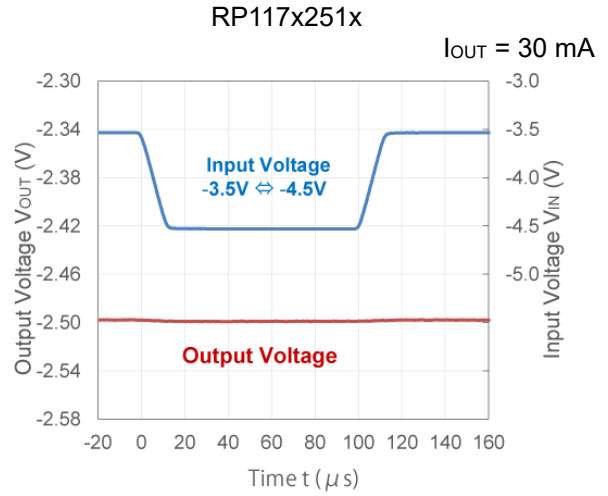
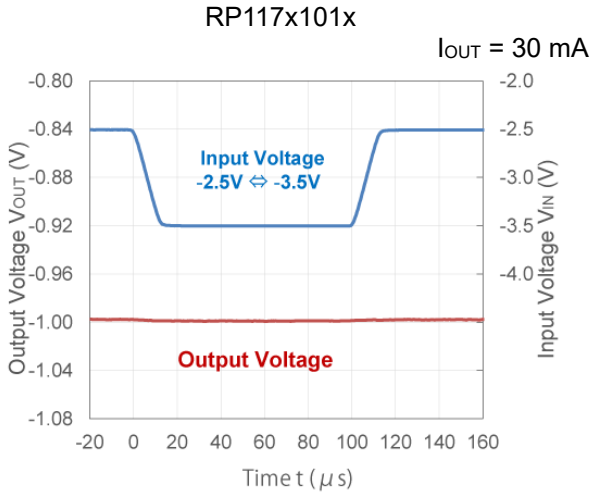

13) Load Transient Response ($C_{IN} = \text{Ceramic } 1.0 \mu\text{F}$, $C_{OUT} = \text{Ceramic } 2.2 \mu\text{F}$, $t_r = t_f = 0.5 \mu\text{s}$, $T_a = 25^\circ\text{C}$)

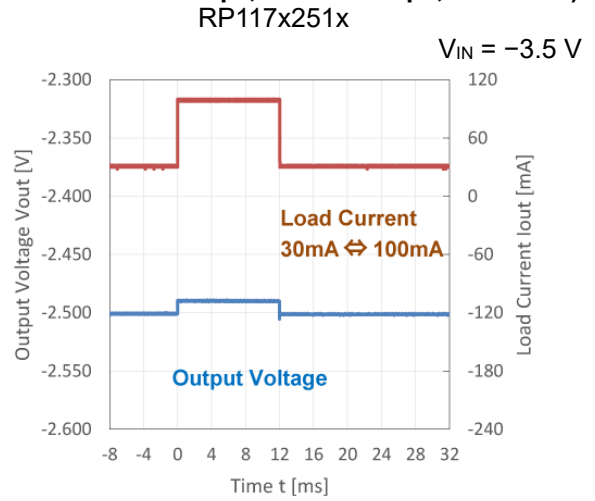
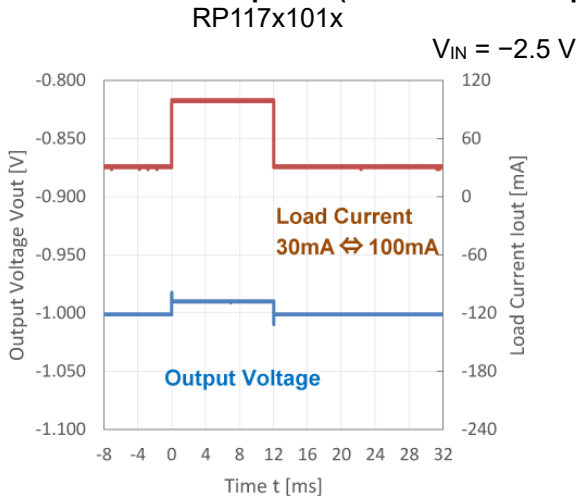

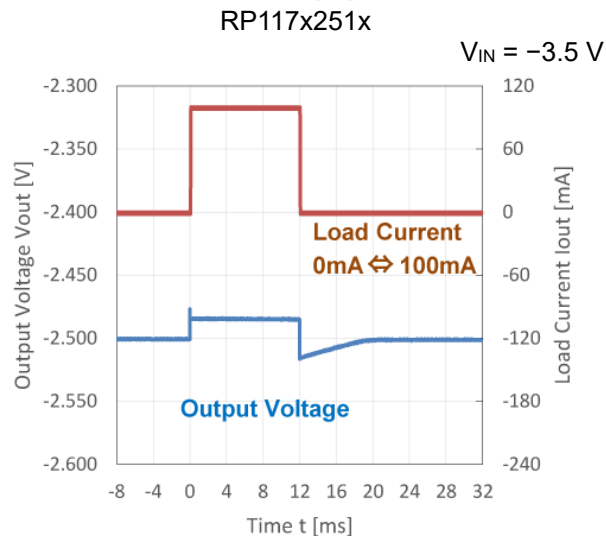
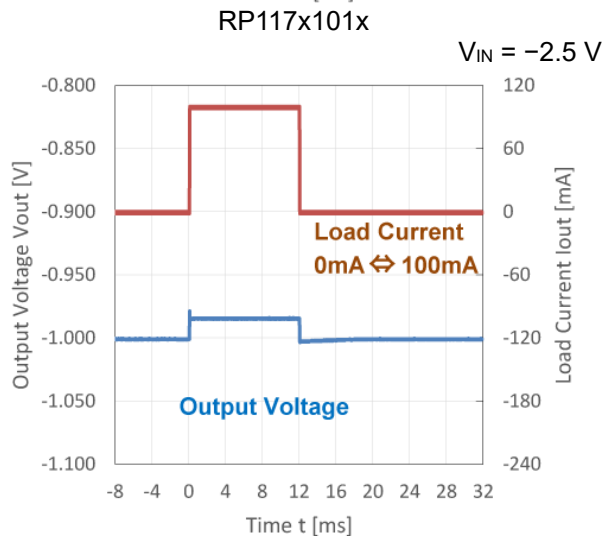
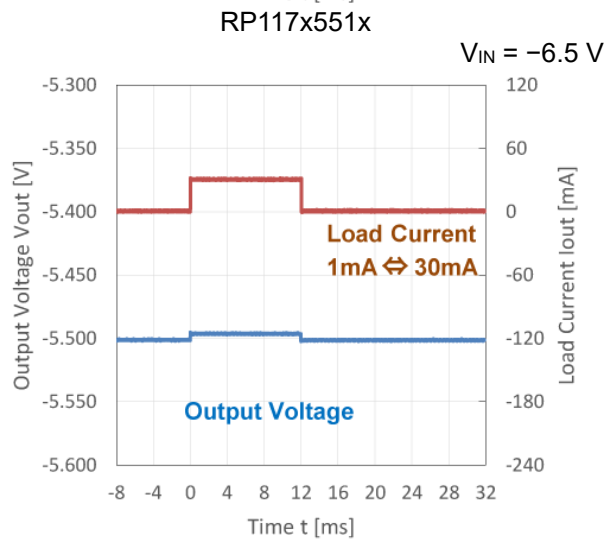
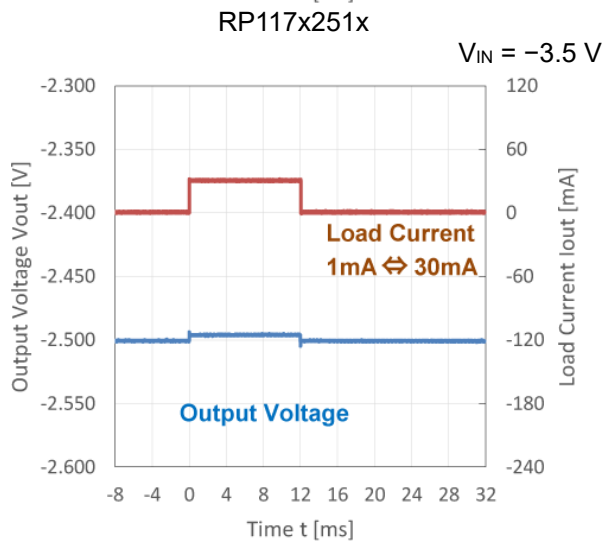
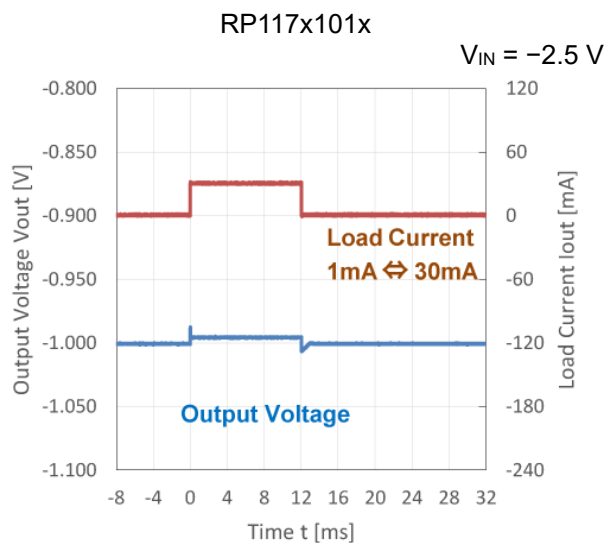
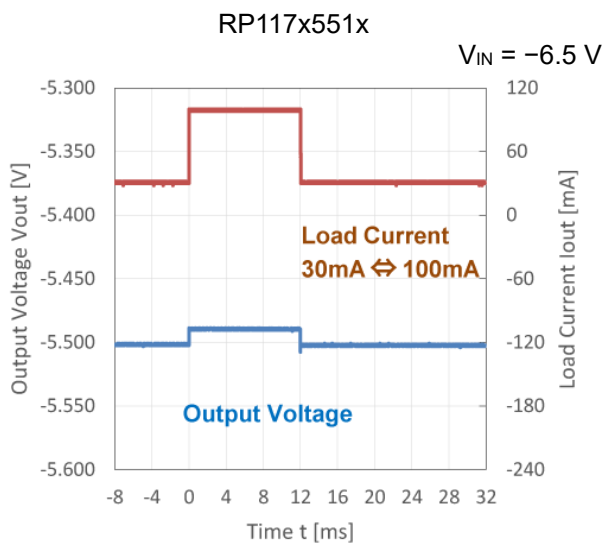

RP117x

No. EA-379-181207

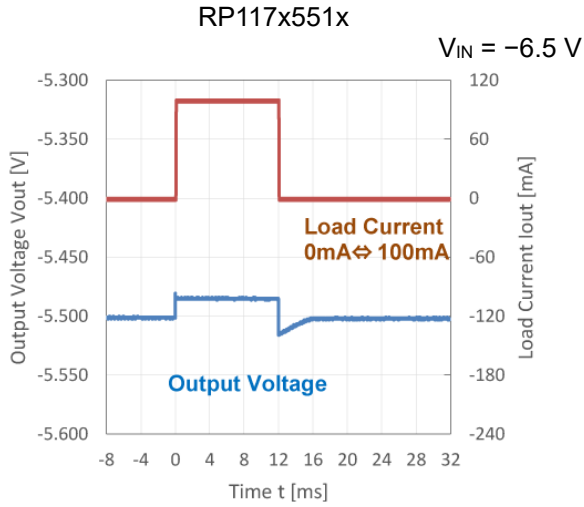

14) CE Pin Start-up Time ($C_{IN} = \text{Ceramic } 1.0\ \mu\text{F}$, $C_{OUT} = \text{Ceramic } 2.2\ \mu\text{F}$, $t_r = t_f = 0.5\ \mu\text{s}$, $T_a = 25^\circ\text{C}$)

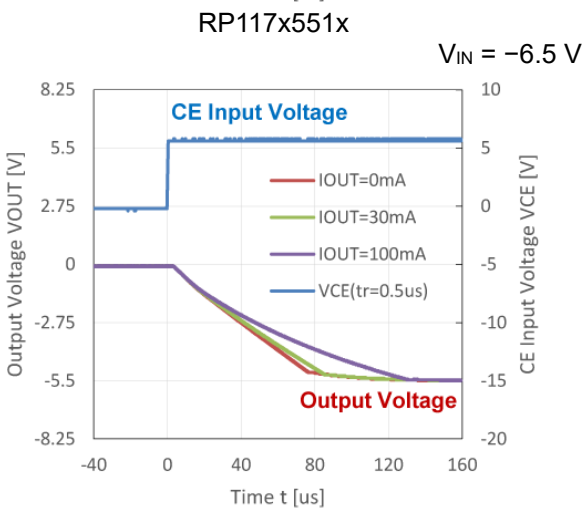
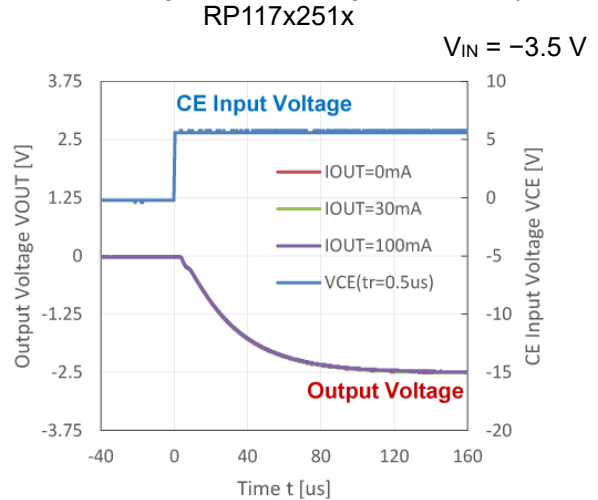
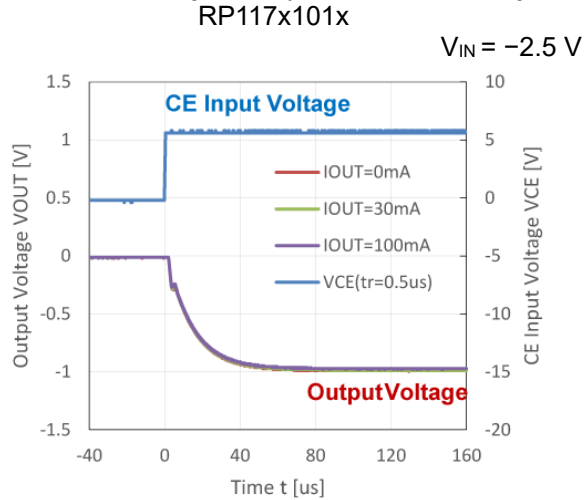

15) CE Pin Shutdown Time (C_{IN} = Ceramic 1.0 μ F, C_{OUT} = Ceramic 2.2 μ F, $t_r = t_f = 0.5 \mu$ s, $T_a = 25^\circ$ C)

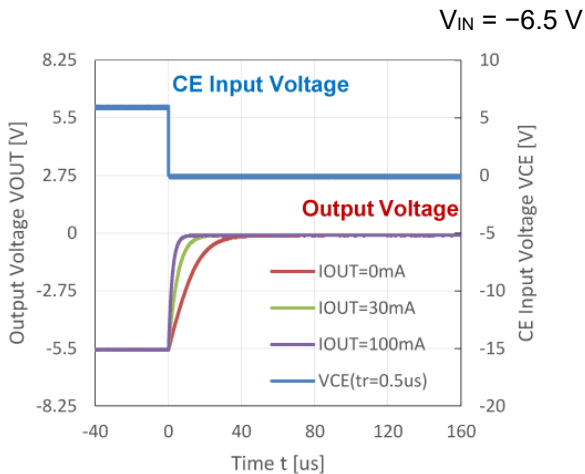
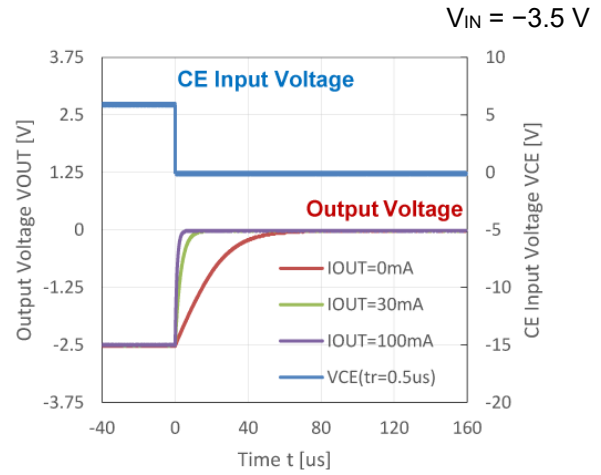
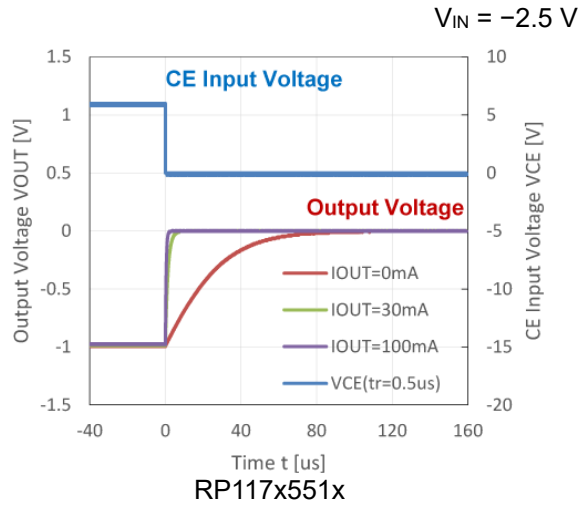

16) Inrush Current (C_{IN} = Ceramic 1.0 μ F, C_{OUT} = Ceramic 2.2 μ F, $t_r = t_f = 0.5 \mu$ s, $T_a = 25^\circ$ C)

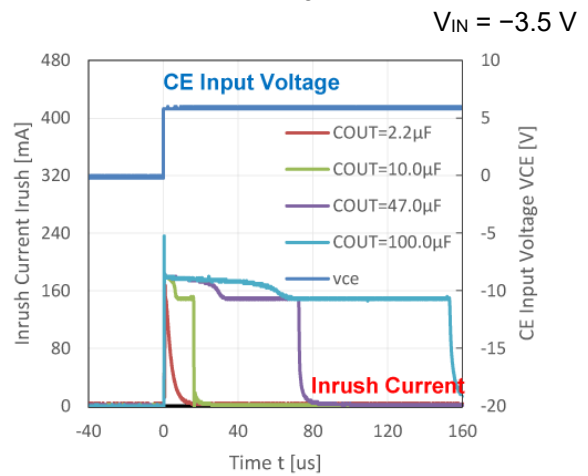
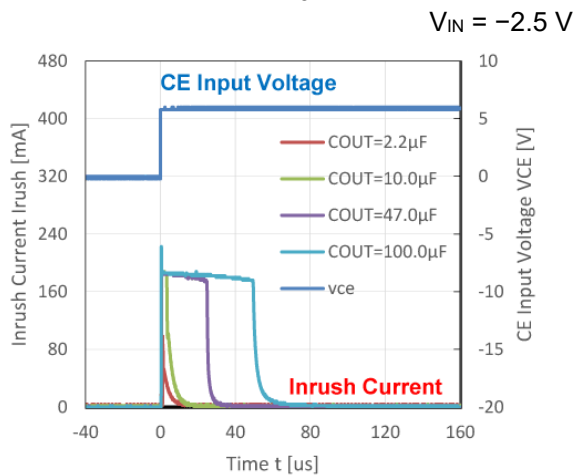

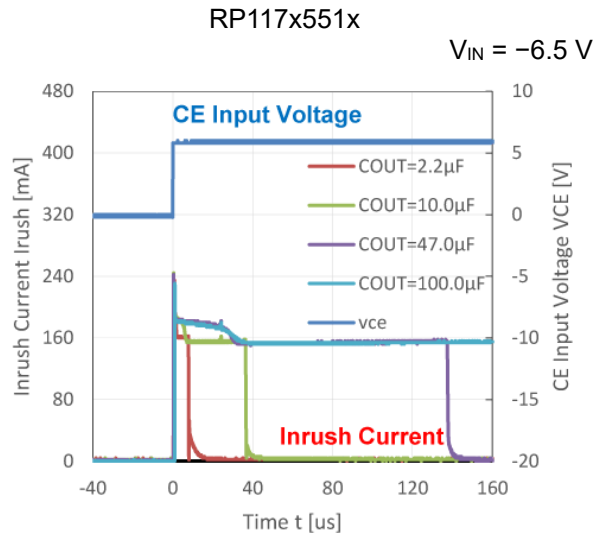

Equivalent Series Resistance (ESR) vs. Output Current

It is recommended that a ceramic type capacitor be used for this device. However, other types of capacitors having lower ESR can also be used. The relation between the output current (I_{OUT}) and the ESR of output capacitor is shown below.

Measurement Conditions

Frequency Band: 10 Hz to 2 MHz

Ambient Temperature: -40°C to 85°C

Input Capacitor (C_{IN}): Ceramic, $1.0\ \mu\text{F}$

Output Capacitor (C_{OUT}): Ceramic, $2.2\ \mu\text{F}$

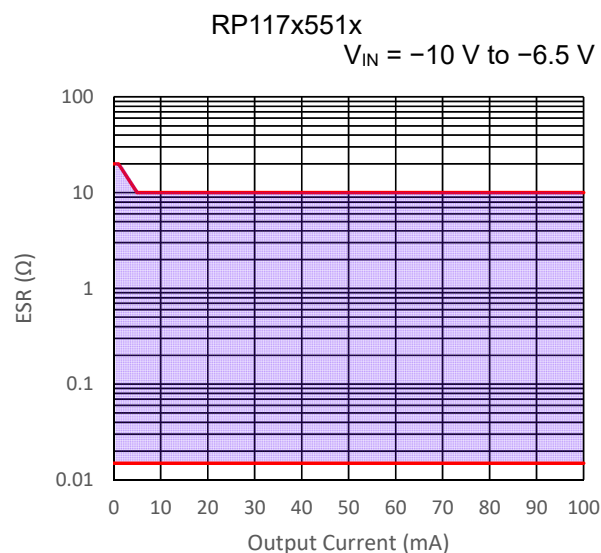
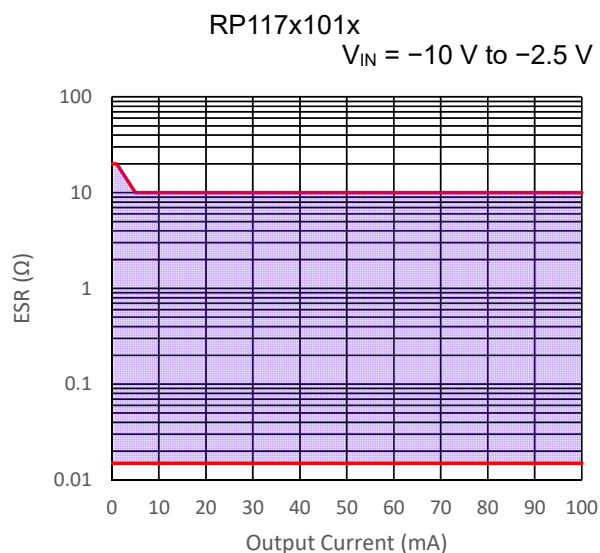

The power dissipation of the package is dependent on PCB material, layout, and environmental conditions. The following measurement conditions are based on JEDEC STD. 51-7.

Measurement Conditions

Item	Measurement Conditions
Environment	Mounting on Board (Wind Velocity = 0 m/s)
Board Material	Glass Cloth Epoxy Plastic (Four-Layer Board)
Board Dimensions	76.2 mm × 114.3 mm × 0.8 mm
Copper Ratio	Outer Layer (First Layer): Less than 95% of 50 mm Square Inner Layers (Second and Third Layers): Approx. 100% of 50 mm Square Outer Layer (Fourth Layer): Approx. 100% of 50 mm Square
Through-holes	φ 0.2 mm × 14 pcs

Measurement Result

(Ta = 25°C, Tjmax = 125°C)

Item	Measurement Result
Power Dissipation	450 mW
Thermal Resistance (θja)	θja = 218°C/W
Thermal Characterization Parameter (ψjt)	ψjt = 105°C/W

θja: Junction-to-Ambient Thermal Resistance

ψjt: Junction-to-Top Thermal Characterization Parameter



Power Dissipation vs. Ambient Temperature



Measurement Board Pattern

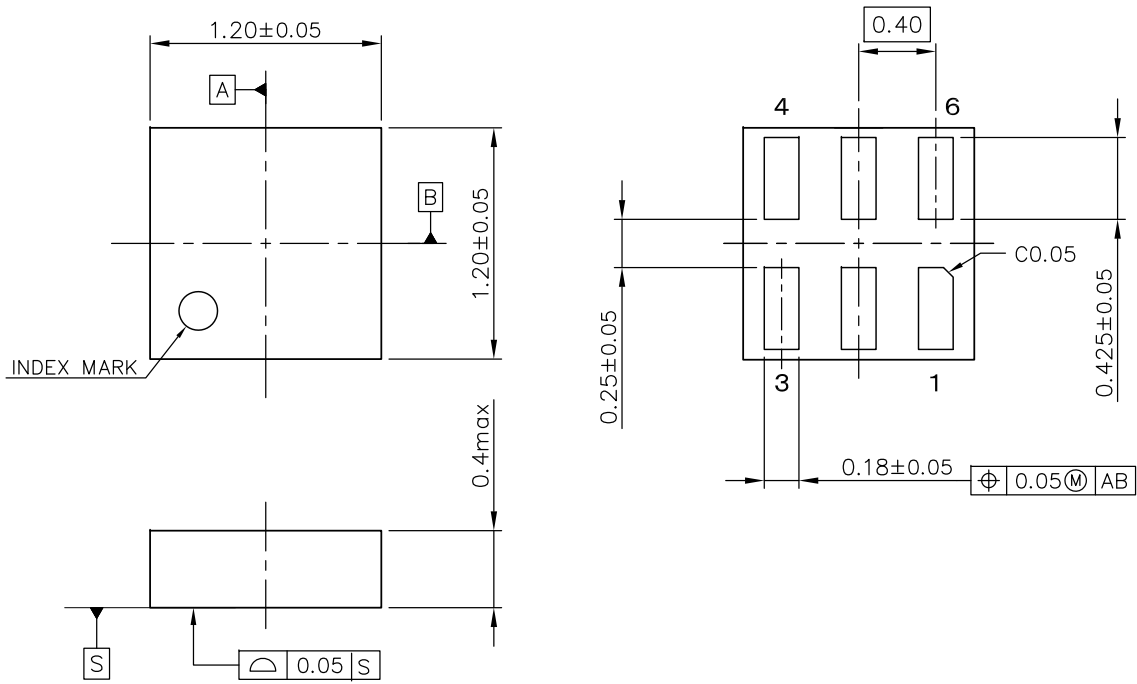

UNIT: mm

DFN(PLP)1212-6 Package Dimensions

The power dissipation of the package is dependent on PCB material, layout, and environmental conditions. The following conditions are used in this measurement.

Measurement Conditions

	Standard Test Land Pattern
Environment	Mounting on Board (Wind Velocity = 0 m/s)
Board Material	Glass Cloth Epoxy Plastic (Double-Sided Board)
Board Dimensions	40 mm × 40 mm × 1.6 mm
Copper Ratio	Top Side: Approx. 50% Bottom Side: Approx. 50%
Through-holes	φ 0.5 mm × 44 pcs

Measurement Result

(Ta = 25°C, Tjmax = 125°C)

	Standard Test Land Pattern	Free Air
Power Dissipation	380 mW	150 mW
Thermal Resistance	$\theta_{ja} = (125 - 25^\circ\text{C}) / 0.38\text{W} = 263^\circ\text{C/W}$ $\theta_{ja} = 75^\circ\text{C/W}$	$\theta_{ja} = (125 - 25^\circ\text{C}) / 0.15\text{W} = 667^\circ\text{C/W}$ -

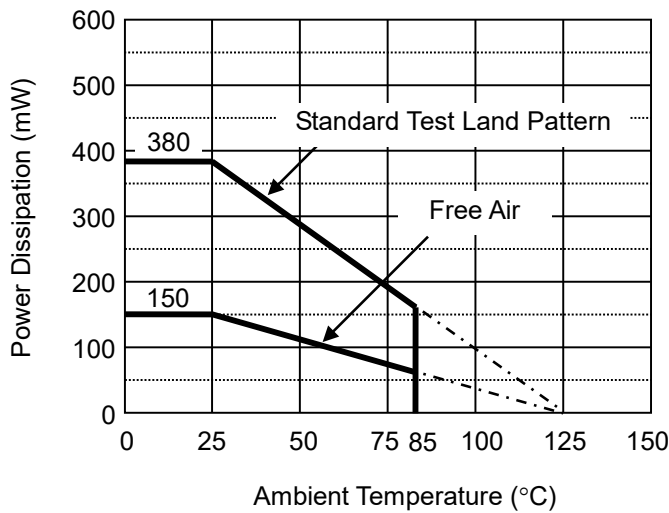

Power Dissipation vs. Ambient Temperature

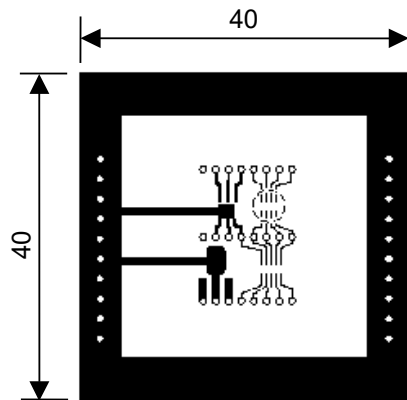

○ IC Mount Area (mm)

Measurement Board Pattern

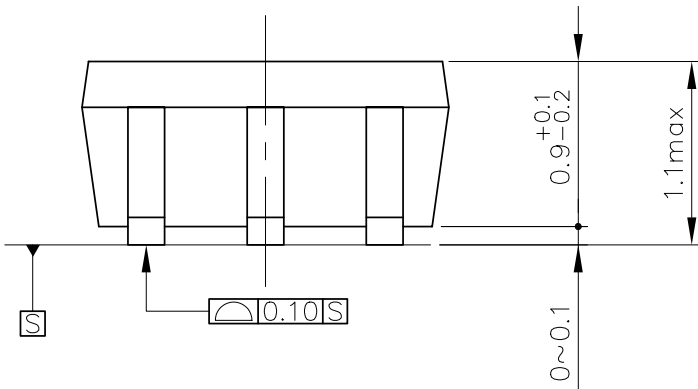
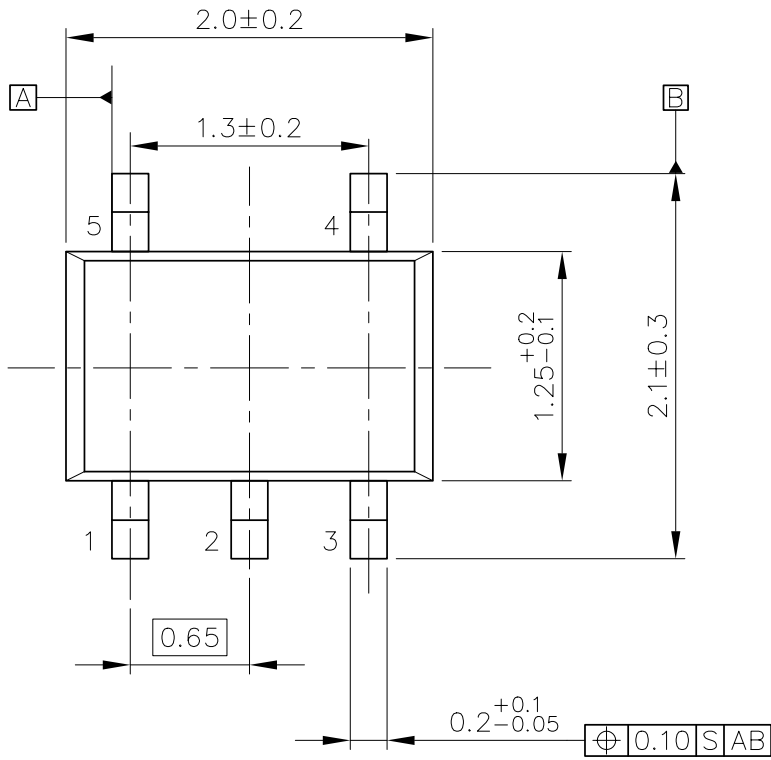

UNIT: mm

SC-88A Package Dimensions



1. The products and the product specifications described in this document are subject to change or discontinuation of production without notice for reasons such as improvement. Therefore, before deciding to use the products, please refer to Ricoh sales representatives for the latest information thereon.
2. The materials in this document may not be copied or otherwise reproduced in whole or in part without prior written consent of Ricoh.
3. Please be sure to take any necessary formalities under relevant laws or regulations before exporting or otherwise taking out of your country the products or the technical information described herein.
4. The technical information described in this document shows typical characteristics of and example application circuits for the products. The release of such information is not to be construed as a warranty of or a grant of license under Ricoh's or any third party's intellectual property rights or any other rights.
5. The products listed in this document are intended and designed for use as general electronic components in standard applications (office equipment, telecommunication equipment, measuring instruments, consumer electronic products, amusement equipment etc.). Those customers intending to use a product in an application requiring extreme quality and reliability, for example, in a highly specific application where the failure or misoperation of the product could result in human injury or death (aircraft, spacevehicle, nuclear reactor control system, traffic control system, automotive and transportation equipment, combustion equipment, safety devices, life support system etc.) should first contact us.
6. We are making our continuous effort to improve the quality and reliability of our products, but semiconductor products are likely to fail with certain probability. In order to prevent any injury to persons or damages to property resulting from such failure, customers should be careful enough to incorporate safety measures in their design, such as redundancy feature, fire containment feature and fail-safe feature. We do not assume any liability or responsibility for any loss or damage arising from misuse or inappropriate use of the products.
7. Anti-radiation design is not implemented in the products described in this document.
8. The X-ray exposure can influence functions and characteristics of the products. Confirm the product functions and characteristics in the evaluation stage.
9. WLCSP products should be used in light shielded environments. The light exposure can influence functions and characteristics of the products under operation or storage.
10. There can be variation in the marking when different AOI (Automated Optical Inspection) equipment is used. In the case of recognizing the marking characteristic with AOI, please contact Ricoh sales or our distributor before attempting to use AOI.
11. Please contact Ricoh sales representatives should you have any questions or comments concerning the products or the technical information.



Ricoh is committed to reducing the environmental loading materials in electrical devices with a view to contributing to the protection of human health and the environment.

Ricoh has been providing RoHS compliant products since April 1, 2006 and Halogen-free products since April 1, 2012.

RICOH RICOH ELECTRONIC DEVICES CO., LTD.

<https://www.e-devices.ricoh.co.jp/en/>

Sales & Support Offices

Ricoh Electronic Devices Co., Ltd.

Shin-Yokohama Office (International Sales)

2-3, Shin-Yokohama 3-chome, Kohoku-ku, Yokohama-shi, Kanagawa, 222-8530, Japan
Phone: +81-50-3814-7687 Fax: +81-45-474-0074

Ricoh Americas Holdings, Inc.

675 Campbell Technology Parkway, Suite 200 Campbell, CA 95008, U.S.A.
Phone: +1-408-610-3105

Ricoh Europe (Netherlands) B.V.

Semiconductor Support Centre

Prof. W.H. Keesomlaan 1, 1183 DJ Amstelveen, The Netherlands
Phone: +31-20-5474-309

Ricoh International B.V. - German Branch

Semiconductor Sales and Support Centre

Oberrather Strasse 6, 40472 Düsseldorf, Germany
Phone: +49-211-6546-0

Ricoh Electronic Devices Korea Co., Ltd.

3F, Haesung Bldg, 504, Teheran-ro, Gangnam-gu, Seoul, 135-725, Korea
Phone: +82-2-2135-5700 Fax: +82-2-2051-5713

Ricoh Electronic Devices Shanghai Co., Ltd.

Room 403, No.2 Building, No.690 Bibo Road, Pu Dong New District, Shanghai 201203,
People's Republic of China
Phone: +86-21-5027-3200 Fax: +86-21-5027-3299

Ricoh Electronic Devices Shanghai Co., Ltd.

Shenzhen Branch

1205, Block D (Jinlong Building), Kingkey 100, Hongbao Road, Luohu District,
Shenzhen, China
Phone: +86-755-8348-7600 Ext 225

Ricoh Electronic Devices Co., Ltd.

Taipei office

Room 109, 10F-1, No.51, Hengyang Rd., Taipei City, Taiwan
Phone: +886-2-2313-1621/1622 Fax: +886-2-2313-1623

Mouser Electronics

Authorized Distributor

Click to View Pricing, Inventory, Delivery & Lifecycle Information:

[Ricoch Electronics:](#)

[RP117K111D-TR](#) [RP117K121D-TR](#) [RP117K131D-TR](#) [RP117K151D-TR](#) [RP117K311D-TR](#) [RP117Q252D-TR-FE](#)



Компания «ЭлектроПласт» предлагает заключение долгосрочных отношений при поставках импортных электронных компонентов на взаимовыгодных условиях!

Наши преимущества:

- Оперативные поставки широкого спектра электронных компонентов отечественного и импортного производства напрямую от производителей и с крупнейших мировых складов;
- Поставка более 17-ти миллионов наименований электронных компонентов;
- Поставка сложных, дефицитных, либо снятых с производства позиций;
- Оперативные сроки поставки под заказ (от 5 рабочих дней);
- Экспресс доставка в любую точку России;
- Техническая поддержка проекта, помощь в подборе аналогов, поставка прототипов;
- Система менеджмента качества сертифицирована по Международному стандарту ISO 9001;
- Лицензия ФСБ на осуществление работ с использованием сведений, составляющих государственную тайну;
- Поставка специализированных компонентов (Xilinx, Altera, Analog Devices, Intersil, Interpoint, Microsemi, Aeroflex, Peregrine, Syfer, Eurofarad, Texas Instrument, Miteq, Cobham, E2V, MA-COM, Hittite, Mini-Circuits, General Dynamics и др.);

Помимо этого, одним из направлений компании «ЭлектроПласт» является направление «Источники питания». Мы предлагаем Вам помощь Конструкторского отдела:

- Подбор оптимального решения, техническое обоснование при выборе компонента;
- Подбор аналогов;
- Консультации по применению компонента;
- Поставка образцов и прототипов;
- Техническая поддержка проекта;
- Защита от снятия компонента с производства.



Как с нами связаться

Телефон: 8 (812) 309 58 32 (многоканальный)

Факс: 8 (812) 320-02-42

Электронная почта: org@eplast1.ru

Адрес: 198099, г. Санкт-Петербург, ул. Калинина, дом 2, корпус 4, литера А.