

## 100 mA Low Noise, High Ripple Rejection, Negative-voltage LDO Regulator

No. EA-379-181207

### OVERVIEW

The RP117x is a negative voltage LDO regulator that provides high ripple rejection and low output noise. Adding only one capacitor to each input and output pin can make a simple structure and high performance LDO regulator.

### KEY BENEFITS

- Provides high ripple rejection rate and low output noise, which is ideal for noise-sensitive devices.
- Requires only one capacitor for each input and output pin, and is available in small DFN(PLP)1212-6 and SC-88A packages, both of which can utilize the space on board.

### KEY SPECIFICATIONS

- Input Voltage Range:  $-10.0\text{ V}$  to  $-2.5\text{ V}$
- Output Voltage Range:  $-5.5\text{ V}$  to  $-1.0\text{ V}$
- Output Current: 100 mA
- Supply Current: Typ. 75  $\mu\text{A}$
- Ripple Rejection Rate: Typ. 80 dB,  $f = 1\text{ kHz}$
- Output Noise: Typ. 16  $\mu\text{Vrms}$   
( $V_{\text{SET}} = -5.5\text{ V}$  to  $-2.0\text{ V}$ )
- Protection Features: Thermal Shutdown Protection  
Short-circuit Protection
- Auto-discharge Function

### TYPICAL APPLICATIONS

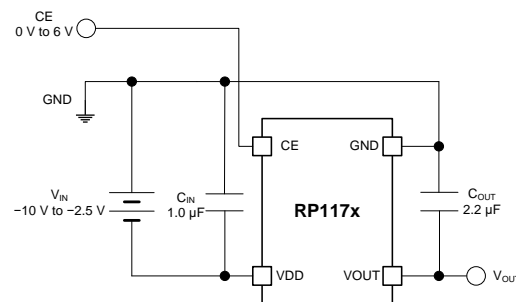

### PACKAGE

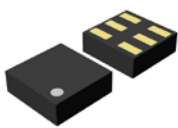

DFN(PLP)1212-6  
1.20 x 1.20 x 0.4<sup>(1)</sup> (mm)  
<sup>(1)</sup> maximum dimension

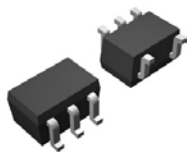

SC-88A  
2.0 x 2.1 x 0.9 (mm)

### SELECTION GUIDE

The set output voltage and the package type are user-selectable options.

Product Name	Package
RP117Kxx1D-TR	DFN(PLP)1212-6
RP117Qxx2D-TR-FE	SC-88A

xx: Specify the set output voltage ( $V_{\text{SET}}$ ) within the range of  $-5.5\text{ V}$  to  $-1.0\text{ V}$  in 0.1 V steps.

### APPLICATIONS

- Noise-sensitive Devices: Sensors, DACs, ADCs, Amplifiers
- Audio Devices, DSLRs
- Measuring Instruments
- Liquid Crystal Panels, Bias Power Supply for CCDs

---

## RP117x

---

No. EA-379-181207

### SELECTION GUIDE

The RP117x includes an auto-discharge function<sup>(1)</sup>. A set output voltage and a package type are user-selectable options.

#### Selection Guide

Product Name	Package	Quantity per Real	Pb Free	Halogen Free
RP117Kxx1D-TR	DFN(PLP)1212-6	5,000 pcs	Yes	Yes
RP117Qxx2D-TR-FE	SC-88A	3,000 pcs	Yes	Yes

xx: Specify the set output voltage ( $V_{SET}$ ) within the range of  $-5.5\text{ V}$  to  $-1.0\text{ V}$  in  $0.1\text{ V}$  steps.

The voltage in  $0.05\text{ V}$  step is shown as follows:

Ex.  $-1.35\text{ V}$ : RP117x13xx5

---

### BLOCK DIAGRAM

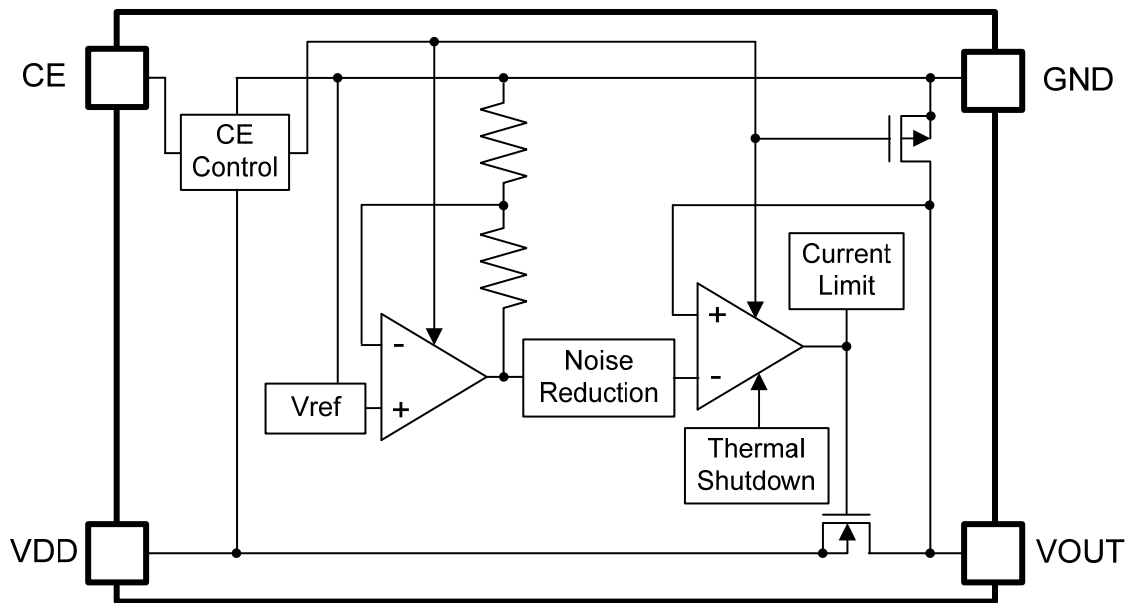

RP117x Block Diagram

---

<sup>(1)</sup> Auto-discharge function quickly lowers the output voltage to  $0\text{ V}$ , when the chip enable signal is switched from the active mode to the standby mode, by releasing the electrical charge accumulated in the external capacitor.

---

## PIN DESCRIPTIONS

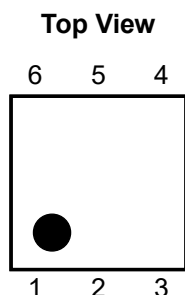

**DFN(PLP)1212-6 Pin Configuration**

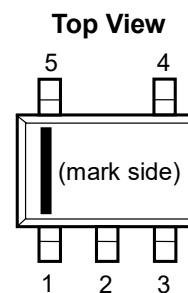
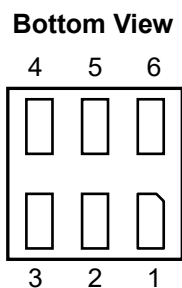

**SC-88A Pin Configuration**

### DFN(PLP)1212-6 Pin Description

Pin No.	Symbol	Description
1	CE	Chip Enable Pin, Active-high
2	NC	No Connection
3	VDD	Input Pin
4	VOUT	Output Pin
5	NC	No Connection
6	GND	Ground Pin

### SC-88A Pin Description

Pin No.	Symbol	Description
1	GND	Ground Pin
2	VDD	Input Pin
3	VOUT	Output Pin
4	CE	Chip Enable Pin, Active-high
5	NC	No Connection

## RP117x

No. EA-379-181207

## ABSOLUTE MAXIMUM RATINGS

### Absolute Maximum Ratings

Symbol	Parameter		Rating	Unit
$V_{IN}$	Input Voltage		-11.0 to 0.3	V
$V_{CE}$	CE Pin Voltage		-0.3 to 7.0	V
$V_{OUT}$	VOUT Pin Voltage		$V_{IN} - 0.3$ to 0.3	V
$I_{OUT}$	Output Current		220	mA
$P_D$	Power Dissipation <sup>(1)</sup>	DFN(PLP)1212-6 (JEDEC STD.51)	450	mW
		SC-88A (Standard Test Land Pattern)	380	mW
$T_j$	Junction Temperature		-40 to 125	°C
$T_{stg}$	Storage Temperature Range		-55 to 125	°C

### ABSOLUTE MAXIMUM RATINGS

Electronic and mechanical stress momentarily exceeded absolute maximum ratings may cause the permanent damages and may degrade the life time and safety for both device and system using the device in the field. The functional operation at or over these absolute maximum ratings is not assured.

## RECOMMENDED OPERATING TEMPERATURE

### Recommended Operating Conditions

Symbol	Parameter	Rating	Unit
$V_{IN}$	Input Voltage	-10.0 to -2.5	V
$V_{CE}$	CE Pin Voltage	0 to 6.0	V
$T_a$	Operating Temperature	-40 to 85	°C

### RECOMMENDED OPERATING CONDITIONS

All of electronic equipment should be designed that the mounted semiconductor devices operate within the recommended operating conditions. The semiconductor devices cannot operate normally over the recommended operating conditions, even if when they are used over such conditions by momentary electronic noise or surge. And the semiconductor devices may receive serious damage when they continue to operate over the recommended operating conditions.

<sup>(1)</sup> Please refer to *POWER DISSIPATION* for detailed information.

## ELECTRICAL CHARACTERISTICS

$V_{IN} = V_{SET} - 1.0\text{ V}$  ( $V_{SET} > -1.5\text{ V}$ ,  $V_{IN} = -2.5\text{ V}$ ),  $I_{OUT} = 1\text{ mA}$ ,  $C_{IN} = 1.0\text{ }\mu\text{F}$ ,  $C_{OUT} = 2.2\text{ }\mu\text{F}$ , unless otherwise noted.

The specifications surrounded by   are guaranteed by design engineering at  $-40^{\circ}\text{C} \leq T_a \leq 85^{\circ}\text{C}$ .

### RP117x Electrical Characteristics

( $T_a = 25^{\circ}\text{C}$ )

Symbol	Parameter	Test Conditions/Comments	Min.	Typ.	Max.	Unit
$V_{OUT}$	Output Voltage	$T_a = 25^{\circ}\text{C}$	x 1.020		x 0.980	V
		$-40^{\circ}\text{C} \leq T_a \leq 85^{\circ}\text{C}$	<span style="border: 1px solid black; padding: 0 2px;">x 1.050</span>		<span style="border: 1px solid black; padding: 0 2px;">x 0.950</span>	V
$I_{OUT}$	Output Current		<span style="border: 1px solid black; padding: 0 2px;">100</span>			mA
$\frac{\Delta V_{OUT}}{\Delta I_{OUT}}$	Load Regulation	$1\text{ mA} \leq I_{OUT} \leq 100\text{ mA}$		10	<span style="border: 1px solid black; padding: 0 2px;">30</span>	mV
$V_{DIF}$	Dropout Voltage	$I_{OUT} = 100\text{ mA}$	Refer to <i>PRODUCT-SPECIFIC ELECTRICAL CHARACTERISTICS</i>			
$I_{SS}$	Supply Current	$I_{OUT} = 0\text{ mA}$		75	<span style="border: 1px solid black; padding: 0 2px;">150</span>	$\mu\text{A}$
$I_{STANDBY}$	Standby Current	$V_{CE} = 0\text{ V}$		0.01	0.15	$\mu\text{A}$
$\frac{\Delta V_{OUT}}{\Delta V_{IN}}$	Line Regulation	$-10.0\text{ V} \leq V_{IN} \leq V_{SET} - 0.5\text{ V}$ (Up to $-2.5\text{ V}$ )	<span style="border: 1px solid black; padding: 0 2px;">-0.30</span>		<span style="border: 1px solid black; padding: 0 2px;">0.30</span>	%/V
RR	Ripple Rejection	$f = 1\text{ kHz}$ , Ripple $0.2\text{ V}_{p-p}$ , $V_{IN} = V_{SET} - 1.0\text{ V}$ , $I_{OUT} = 30\text{ mA}$ ( $V_{SET} \geq -2.5\text{ V}$ , $V_{IN} = -3.5\text{ V}$ )		80		dB
$V_{IN}$	Input Voltage		<span style="border: 1px solid black; padding: 0 2px;">-10.0</span>		<span style="border: 1px solid black; padding: 0 2px;">-2.5</span>	V
$\frac{\Delta V_{OUT}}{\Delta T_a}$	Output Voltage Temperature Coefficient	$-40^{\circ}\text{C} \leq T_a \leq 85^{\circ}\text{C}$		$\pm 100$		ppm/ $^{\circ}\text{C}$
$I_{SC}$	Short Current Limit	$V_{OUT} = 0\text{ V}$		150		mA
$R_{CE}$	CE Pull-down Resistance	$V_{IN} = -5\text{ V}$ , $V_{CE} = 3\text{ V}$		5		M $\Omega$
$V_{CEH}$	CE Pin Input Voltage, high		<span style="border: 1px solid black; padding: 0 2px;">1.5</span>			V
$V_{CEL}$	CE Pin Input Voltage, low				<span style="border: 1px solid black; padding: 0 2px;">0.5</span>	V
en	Output Noise	BW = 10 Hz to 100 kHz, $I_{OUT} = 30\text{ mA}$	$V_{SET} > -2.0\text{ V}$	44 – 13 x $ V_{SET} $		$\mu\text{V}_{rms}$
			$V_{SET} \leq -2.0\text{ V}$	16		
$T_{TSD}$	Thermal Shutdown Temperature Threshold, rising	Junction Temperature		165		$^{\circ}\text{C}$
$T_{TSR}$	Thermal Shutdown Temperature Threshold, falling	Junction Temperature		110		$^{\circ}\text{C}$
$R_{LOW}$	Auto-discharge PMOS On Resistance	$V_{IN} = -4.0\text{ V}$ , $V_{CE} = 0\text{ V}$		250		$\Omega$

All test items listed under *Electrical Characteristics* are done under the pulse load condition ( $T_j \approx T_a = 25^{\circ}\text{C}$ ) except Output Voltage Temperature Coefficient, Output Noise and Ripple Rejection.

## RP117x

No. EA-379-181207

### ELECTRICAL CHARACTERISTICS (continued)

The specifications surrounded by   are guaranteed by design engineering at  $-40^{\circ}\text{C} \leq T_a \leq 85^{\circ}\text{C}$ .

#### RP117x Product-specific Electrical Characteristics

Product Name	V <sub>OUT</sub> [V]						V <sub>DIF</sub> [V]	
	T <sub>a</sub> = 25°C			-40°C ≤ T <sub>a</sub> ≤ 85°C			Typ.	Max.
	Min.	Typ.	Max.	Min.	Typ.	Max.		
RP117x10xx	-1.020	-1.000	-0.980	<span style="border: 1px solid black;">-1.050</span>	-1.000	<span style="border: 1px solid black;">-0.950</span>	(1)	(1)
RP117x11xx	-1.122	-1.100	-1.078	<span style="border: 1px solid black;">-1.155</span>	-1.100	<span style="border: 1px solid black;">-1.045</span>		
RP117x12xx	-1.224	-1.200	-1.176	<span style="border: 1px solid black;">-1.260</span>	-1.200	<span style="border: 1px solid black;">-1.140</span>		
RP117x13xx	-1.326	-1.300	-1.274	<span style="border: 1px solid black;">-1.365</span>	-1.300	<span style="border: 1px solid black;">-1.235</span>		
RP117x13xx5	-1.377	-1.350	-1.323	<span style="border: 1px solid black;">-1.417</span>	-1.350	<span style="border: 1px solid black;">-1.283</span>		
RP117x14xx	-1.428	-1.400	-1.372	<span style="border: 1px solid black;">-1.470</span>	-1.400	<span style="border: 1px solid black;">-1.330</span>		
RP117x15xx	-1.530	-1.500	-1.470	<span style="border: 1px solid black;">-1.575</span>	-1.500	<span style="border: 1px solid black;">-1.425</span>	0.66 <sup>(1)</sup>	<span style="border: 1px solid black;">0.7</span>
RP117x16xx	-1.632	-1.600	-1.568	<span style="border: 1px solid black;">-1.680</span>	-1.600	<span style="border: 1px solid black;">-1.520</span>		
RP117x17xx	-1.734	-1.700	-1.666	<span style="border: 1px solid black;">-1.785</span>	-1.700	<span style="border: 1px solid black;">-1.615</span>		
RP117x18xx	-1.836	-1.800	-1.764	<span style="border: 1px solid black;">-1.890</span>	-1.800	<span style="border: 1px solid black;">-1.710</span>		
RP117x19xx	-1.938	-1.900	-1.862	<span style="border: 1px solid black;">-1.995</span>	-1.900	<span style="border: 1px solid black;">-1.805</span>		
RP117x20xx	-2.040	-2.000	-1.960	<span style="border: 1px solid black;">-2.100</span>	-2.000	<span style="border: 1px solid black;">-1.900</span>		
RP117x21xx	-2.142	-2.100	-2.058	<span style="border: 1px solid black;">-2.205</span>	-2.100	<span style="border: 1px solid black;">-1.995</span>	0.31 <sup>(1)</sup>	<span style="border: 1px solid black;">0.45</span>
RP117x22xx	-2.244	-2.200	-2.156	<span style="border: 1px solid black;">-2.310</span>	-2.200	<span style="border: 1px solid black;">-2.090</span>		
RP117x23xx	-2.346	-2.300	-2.254	<span style="border: 1px solid black;">-2.415</span>	-2.300	<span style="border: 1px solid black;">-2.185</span>		
RP117x24xx	-2.448	-2.400	-2.352	<span style="border: 1px solid black;">-2.520</span>	-2.400	<span style="border: 1px solid black;">-2.280</span>		
RP117x25xx	-2.550	-2.500	-2.450	<span style="border: 1px solid black;">-2.625</span>	-2.500	<span style="border: 1px solid black;">-2.375</span>		
RP117x26xx	-2.652	-2.600	-2.548	<span style="border: 1px solid black;">-2.730</span>	-2.600	<span style="border: 1px solid black;">-2.470</span>		
RP117x27xx	-2.754	-2.700	-2.646	<span style="border: 1px solid black;">-2.835</span>	-2.700	<span style="border: 1px solid black;">-2.565</span>		
RP117x28xx	-2.856	-2.800	-2.744	<span style="border: 1px solid black;">-2.940</span>	-2.800	<span style="border: 1px solid black;">-2.660</span>		
RP117x29xx	-2.958	-2.900	-2.842	<span style="border: 1px solid black;">-3.045</span>	-2.900	<span style="border: 1px solid black;">-2.755</span>		
RP117x30xx	-3.060	-3.000	-2.940	<span style="border: 1px solid black;">-3.150</span>	-3.000	<span style="border: 1px solid black;">-2.850</span>		
RP117x31xx	-3.162	-3.100	-3.038	<span style="border: 1px solid black;">-3.255</span>	-3.100	<span style="border: 1px solid black;">-2.945</span>	0.23	<span style="border: 1px solid black;">0.30</span>
RP117x32xx	-3.264	-3.200	-3.136	<span style="border: 1px solid black;">-3.360</span>	-3.200	<span style="border: 1px solid black;">-3.040</span>		
RP117x33xx	-3.366	-3.300	-3.234	<span style="border: 1px solid black;">-3.465</span>	-3.300	<span style="border: 1px solid black;">-3.135</span>		
RP117x34xx	-3.468	-3.400	-3.332	<span style="border: 1px solid black;">-3.570</span>	-3.400	<span style="border: 1px solid black;">-3.230</span>		
RP117x35xx	-3.570	-3.500	-3.430	<span style="border: 1px solid black;">-3.675</span>	-3.500	<span style="border: 1px solid black;">-3.325</span>		
RP117x36xx	-3.672	-3.600	-3.528	<span style="border: 1px solid black;">-3.780</span>	-3.600	<span style="border: 1px solid black;">-3.420</span>		
RP117x37xx	-3.774	-3.700	-3.626	<span style="border: 1px solid black;">-3.885</span>	-3.700	<span style="border: 1px solid black;">-3.515</span>		
RP117x38xx	-3.876	-3.800	-3.724	<span style="border: 1px solid black;">-3.990</span>	-3.800	<span style="border: 1px solid black;">-3.610</span>		
RP117x39xx	-3.978	-3.900	-3.822	<span style="border: 1px solid black;">-4.095</span>	-3.900	<span style="border: 1px solid black;">-3.705</span>		
RP117x40xx	-4.080	-4.000	-3.920	<span style="border: 1px solid black;">-4.200</span>	-4.000	<span style="border: 1px solid black;">-3.800</span>		
RP117x41xx	-4.182	-4.100	-4.018	<span style="border: 1px solid black;">-4.305</span>	-4.100	<span style="border: 1px solid black;">-3.895</span>	0.13	<span style="border: 1px solid black;">0.21</span>
RP117x42xx	-4.284	-4.200	-4.116	<span style="border: 1px solid black;">-4.410</span>	-4.200	<span style="border: 1px solid black;">-3.990</span>		
RP117x43xx	-4.386	-4.300	-4.214	<span style="border: 1px solid black;">-4.515</span>	-4.300	<span style="border: 1px solid black;">-4.085</span>		
RP117x44xx	-4.488	-4.400	-4.312	<span style="border: 1px solid black;">-4.620</span>	-4.400	<span style="border: 1px solid black;">-4.180</span>		
RP117x45xx	-4.590	-4.500	-4.410	<span style="border: 1px solid black;">-4.725</span>	-4.500	<span style="border: 1px solid black;">-4.275</span>		
RP117x46xx	-4.692	-4.600	-4.508	<span style="border: 1px solid black;">-4.830</span>	-4.600	<span style="border: 1px solid black;">-4.370</span>		
RP117x47xx	-4.794	-4.700	-4.606	<span style="border: 1px solid black;">-4.935</span>	-4.700	<span style="border: 1px solid black;">-4.465</span>		
RP117x48xx	-4.896	-4.800	-4.704	<span style="border: 1px solid black;">-5.040</span>	-4.800	<span style="border: 1px solid black;">-4.560</span>		
RP117x49xx	-4.998	-4.900	-4.802	<span style="border: 1px solid black;">-5.145</span>	-4.900	<span style="border: 1px solid black;">-4.655</span>		
RP117x50xx	-5.100	-5.000	-4.900	<span style="border: 1px solid black;">-5.250</span>	-5.000	<span style="border: 1px solid black;">-4.750</span>		
RP117x51xx	-5.202	-5.100	-4.998	<span style="border: 1px solid black;">-5.355</span>	-5.100	<span style="border: 1px solid black;">-4.845</span>		
RP117x52xx	-5.304	-5.200	-5.096	<span style="border: 1px solid black;">-5.460</span>	-5.200	<span style="border: 1px solid black;">-4.940</span>		
RP117x53xx	-5.406	-5.300	-5.194	<span style="border: 1px solid black;">-5.565</span>	-5.300	<span style="border: 1px solid black;">-5.035</span>		
RP117x54xx	-5.508	-5.400	-5.292	<span style="border: 1px solid black;">-5.670</span>	-5.400	<span style="border: 1px solid black;">-5.130</span>		
RP117x55xx	-5.610	-5.500	-5.390	<span style="border: 1px solid black;">-5.775</span>	-5.500	<span style="border: 1px solid black;">-5.225</span>		

<sup>(1)</sup> Input voltage should be equal or less than the maximum operating voltage (-2.5 V).

## THEORY OF OPERATION

### CE Pin Input Current

The CE pin input current is determined by the VDD pin input voltage and the CE pin input voltage as shown in the table below.

		CE Voltage[V]				
		1.5	2	3	4	5
V <sub>in</sub> [V]	-2.5	0.3	0.3	0.4	0.5	0.6
	-3	0.3	0.4	0.5	0.5	0.6
	-4	0.4	0.4	0.5	0.6	0.7
	-5	0.5	0.5	0.6	0.7	0.8
	-6	0.5	0.6	0.7	0.7	0.8
	-7	0.6	0.6	0.7	0.8	0.9
	-8	0.7	0.7	0.8	0.9	1.0
	-9	0.7	0.8	0.9	1.0	1.0
	-10	0.8	0.8	0.9	1.0	1.1

(uA)

RP117x CE Pin Input Current

### Minimum Operating Voltage

The RP 117x does not include an UVLO circuit. To make the internal circuit operate normally and to ensure good output regulation, V<sub>IN</sub> has to be:  $V_{IN} \leq V_{SET} - V_{DIF}$  (Max. -2.5 V). To bring out the best characteristics of the output noise voltage, the ripple rejection and the load transient response, V<sub>IN</sub> has to be  $V_{IN} = V_{SET} - 1.0$  V.

### Thermal Shutdown

Thermal shutdown deactivates a circuit when the junction temperature exceeds the thermal shutdown threshold (T<sub>TSD</sub>) of Typ. 165°C, and reactivates it when the junction temperature falls below the thermal shutdown release threshold (T<sub>TSR</sub>) of Typ. 110°C. During the reactivation, the inrush current limit is in operation. Note that deactivation and activation cycle can be repeated due to load, heat dissipation and ambient temperature conditions. Thermal shutdown cannot be used for the purpose of heat sink, so the repetitive cycles of deactivation and activation may affect the reliability of the device.

---

## RP117x

---

No. EA-379-181207

### APPLICATION INFORMATION

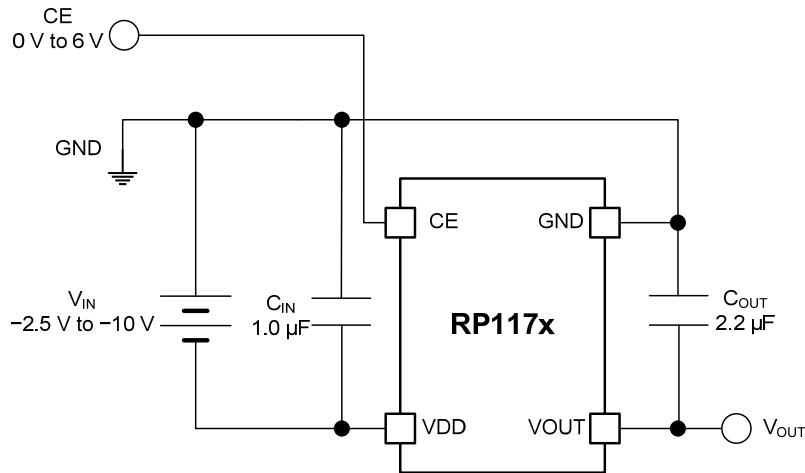

**RP117x Typical Application Circuit**

#### External Components

Symbol	Description
C <sub>IN</sub>	Ceramic Capacitor, 1.0 μF, TDK, CGA3E1X7R1C105K
C <sub>OUT</sub>	Ceramic Capacitor, 2.2 μF, TDK, CGA5L2X7R1E225K

#### Technical Notes on the Selection of External Components

- Phase compensation is provided to secure stable operation even when the load current is varied. For this purpose, use a 2.2-μF or more output capacitor (C<sub>OUT</sub>) with good frequency characteristics and proper ESR (Equivalent Series Resistance). In case of using a tantalum type capacitor with a large ESR, the output might become unstable. Evaluate your circuit including consideration of frequency characteristics.
- The high impedance of the wirings may result in noise pickup and unstable operation of the device. Reduce the impedance of the VDD and GND wirings. Connect a 1.0-μF or more input capacitor (C<sub>IN</sub>) between the VDD and GND pins with shortest-distance wiring. Also, connect a 2.2-μF or more output capacitor (C<sub>OUT</sub>) between the VOUT and GND pins with shortest-distance wiring



## TYPICAL CHARACTERISTICS

Note: Typical Characteristics are intended to be used as reference data; they are not guaranteed.

### 1) Output Voltage vs. Ambient Temperature ( $C_{IN}$ = Ceramic 1.0 $\mu$ F, $C_{OUT}$ = Ceramic 2.2 $\mu$ F)

RP117x101x

$V_{IN} = -2.5$  V,  $I_{OUT} = 1$  mA

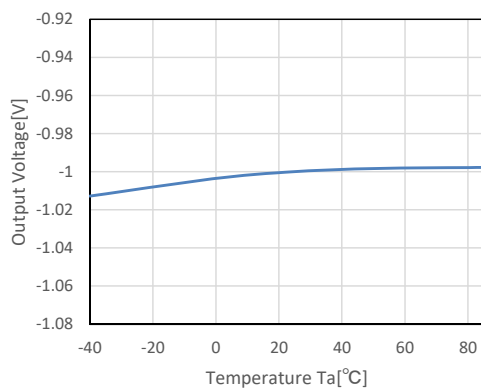

RP117x251x

$V_{IN} = -3.5$  V,  $I_{OUT} = 1$  mA

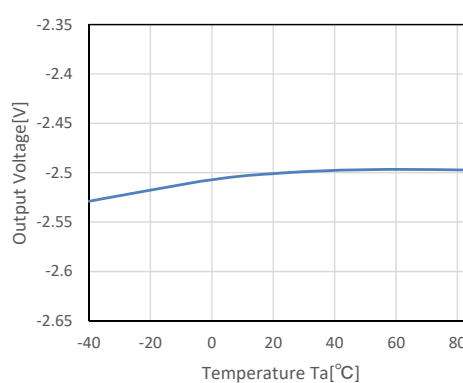

RP117x551x

$V_{IN} = -6.5$  V,  $I_{OUT} = 1$  mA

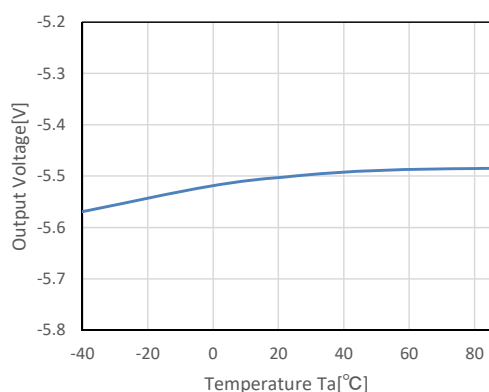

### 2) Supply Current vs. Ambient Temperature ( $C_{IN}$ = Ceramic 1.0 $\mu$ F, $C_{OUT}$ = Ceramic 2.2 $\mu$ F)

RP117x101x

$V_{IN} = -2.5$  V

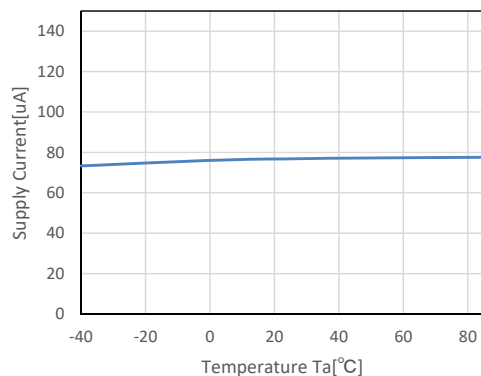

RP117x251x

$V_{IN} = -3.5$  V

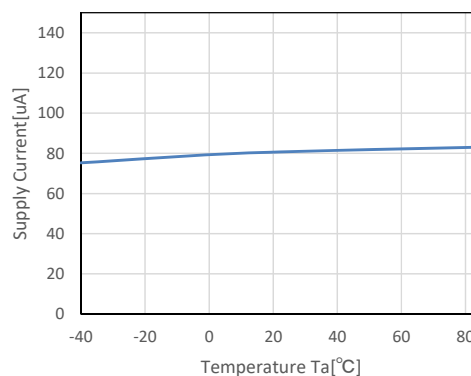

---

# RP117x

---

No. EA-379-181207

RP117x551x

$V_{IN} = -6.5\text{ V}$

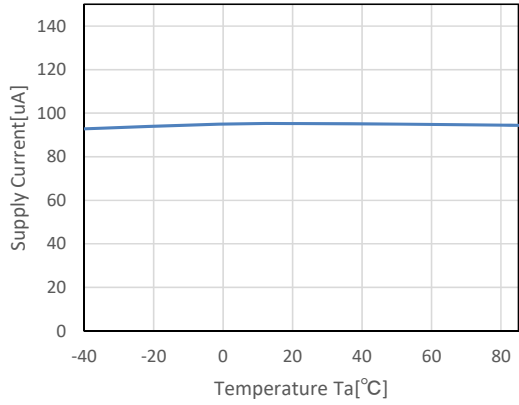

### 3) Dropout Voltage vs. Output Current ( $C_{IN} = \text{Ceramic } 1.0\ \mu\text{F}$ , $C_{OUT} = \text{Ceramic } 2.2\ \mu\text{F}$ )

RP117x101x

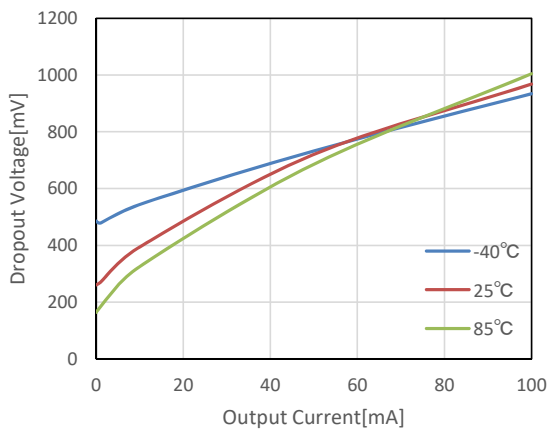

RP117x251x

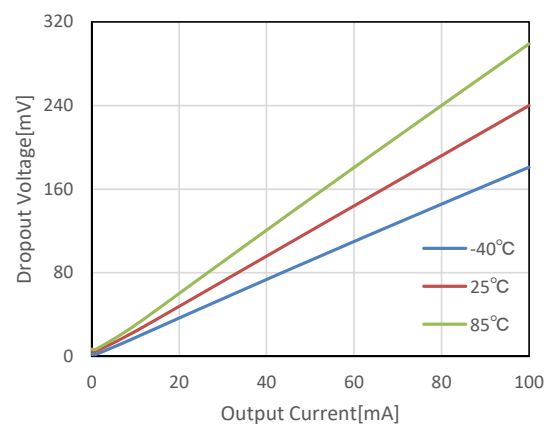

RP117x551x

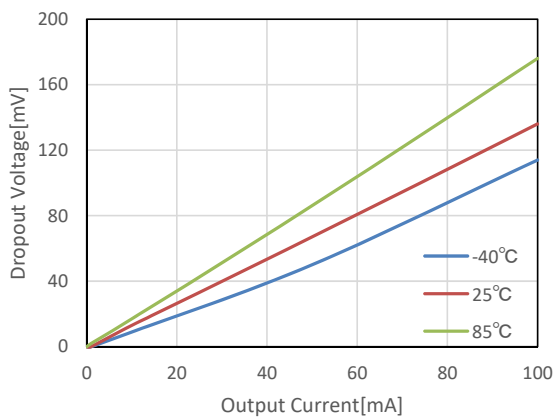

4) Dropout Voltage vs. Set Output Voltage ( $C_{IN}$  = Ceramic 1.0  $\mu$ F,  $C_{OUT}$  = Ceramic 2.2  $\mu$ F,  $T_a$  = 25°C)

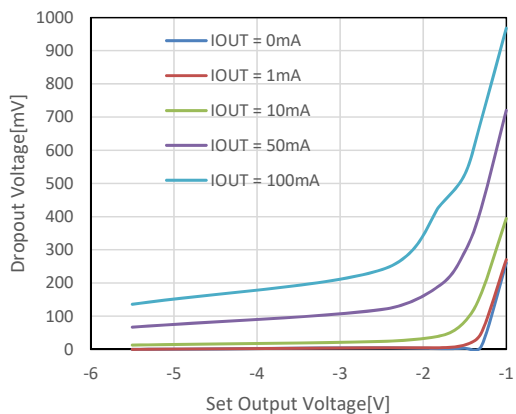

5) Output Voltage vs. Output Current ( $C_{IN}$  = Ceramic 1.0  $\mu$ F,  $C_{OUT}$  = Ceramic 2.2  $\mu$ F,  $T_a$  = 25°C)

RP117x101x

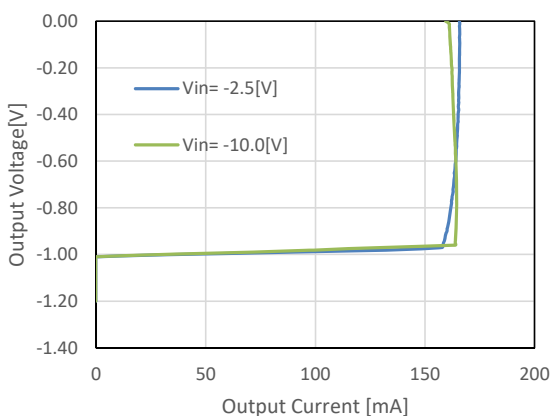

RP117x251x

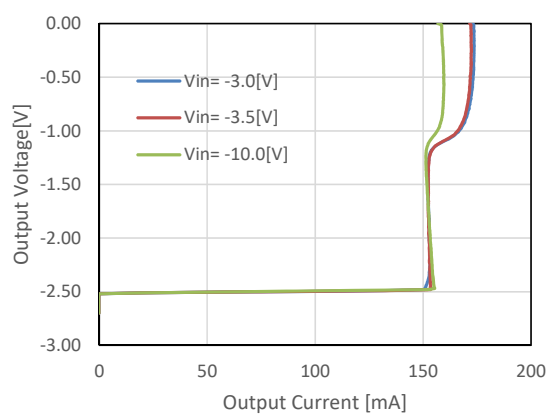

RP117x551x

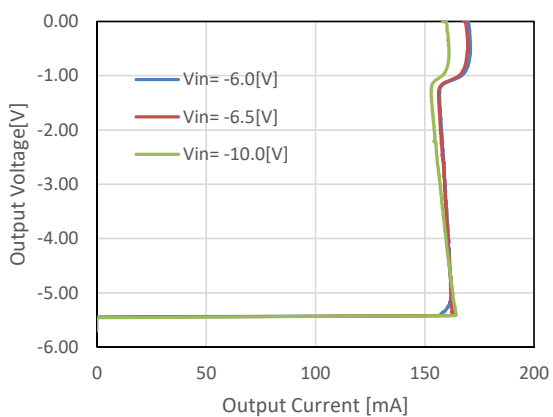

---

## RP117x

---

No. EA-379-181207

### 6) Output Voltage vs. Input Voltage ( $C_{IN}$ = Ceramic 1.0 $\mu$ F, $C_{OUT}$ = Ceramic 2.2 $\mu$ F, $T_a$ = 25°C)

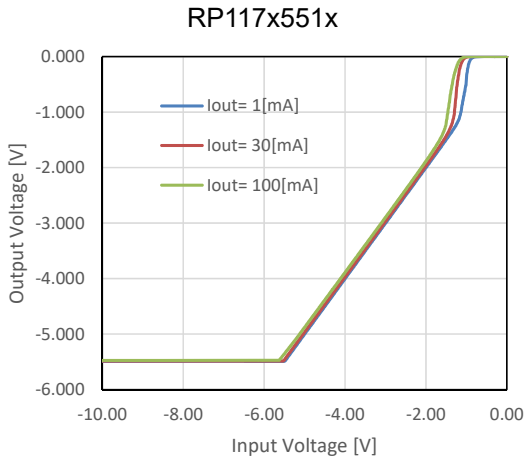
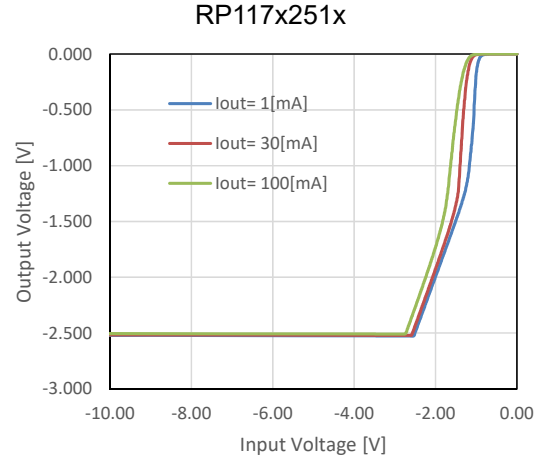
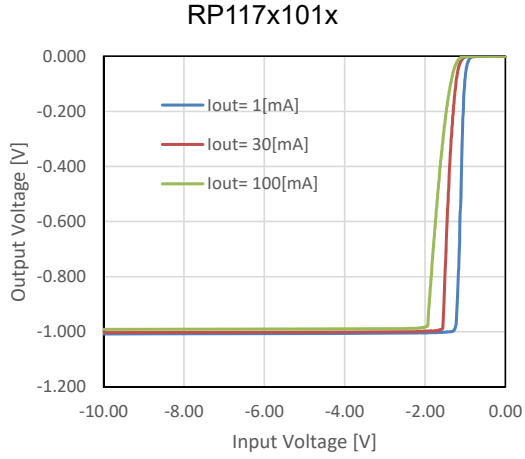

### 7) Supply Current vs. Input Voltage ( $C_{IN}$ = Ceramic 1.0 $\mu$ F, $C_{OUT}$ = Ceramic 2.2 $\mu$ F, $T_a$ = 25°C)

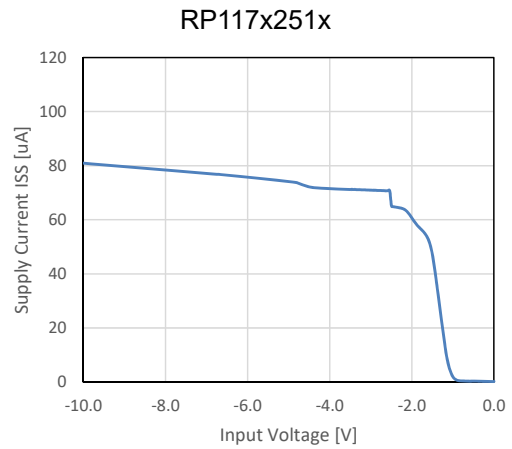
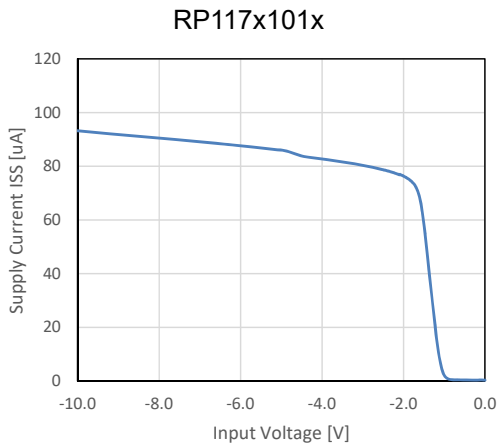

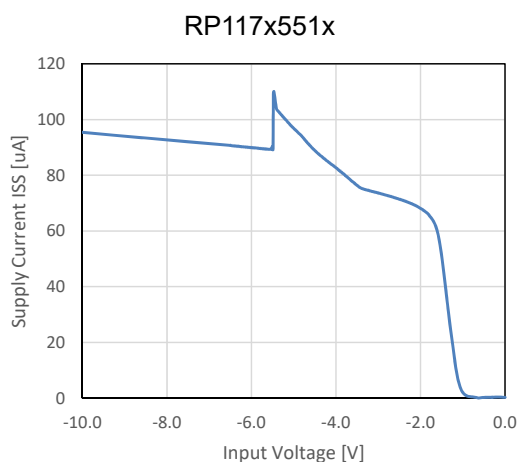

8) Ripple Rejection vs. Frequency ( $C_{IN}$  = none,  $C_{OUT}$  = Ceramic 2.2  $\mu$ F, Ripple = 0.2 Vp-p,  $T_a$  = 25°C)

RP117x101x

$V_{IN} = -3.5$  V

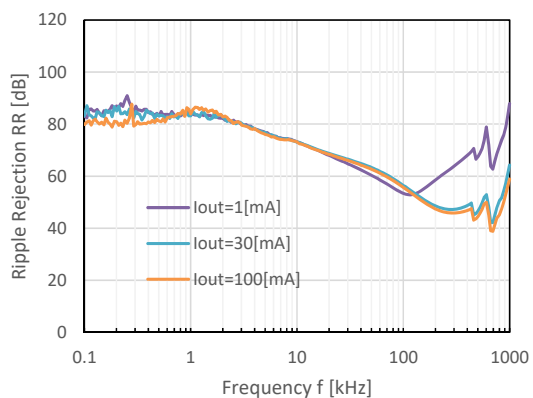

RP117x251x

$V_{IN} = -3.5$  V

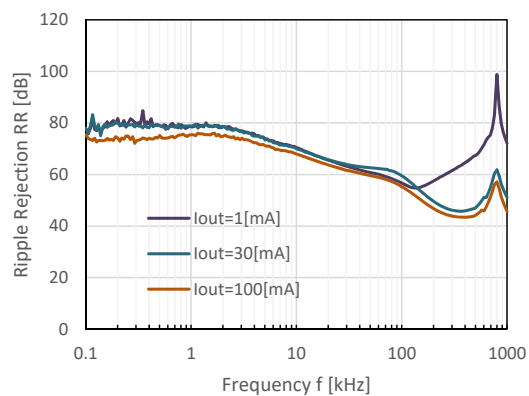

RP117x551x

$V_{IN} = -6.5$  V

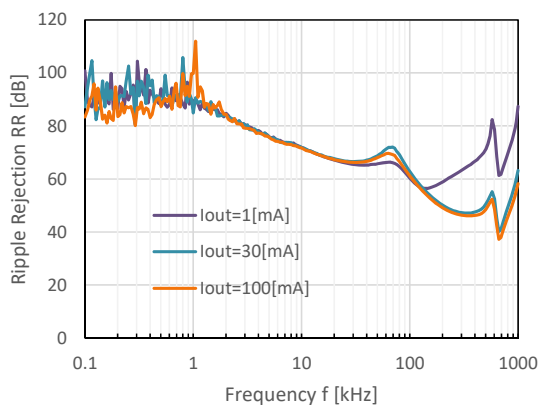

# RP117x

No. EA-379-181207

## 9) Ripple Rejection vs. Input Voltage ( $C_{IN}$ = none, $C_{OUT}$ = Ceramic 2.2 $\mu$ F, Ripple = 0.2 Vp-p, $T_a$ = 25°C)

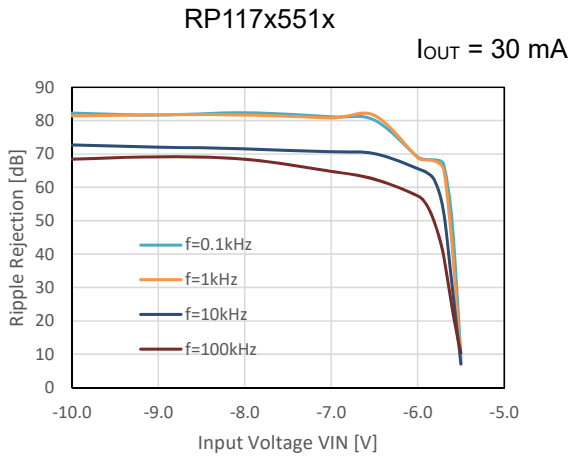
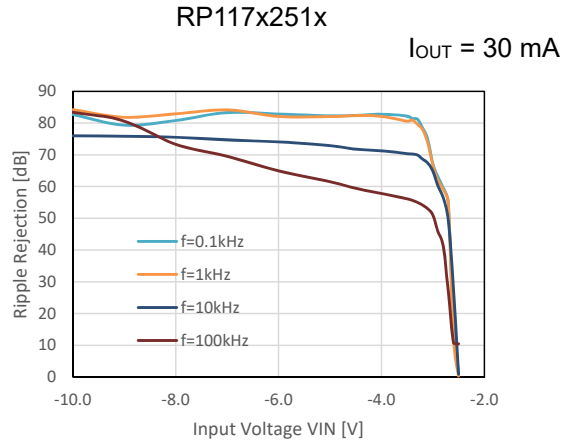
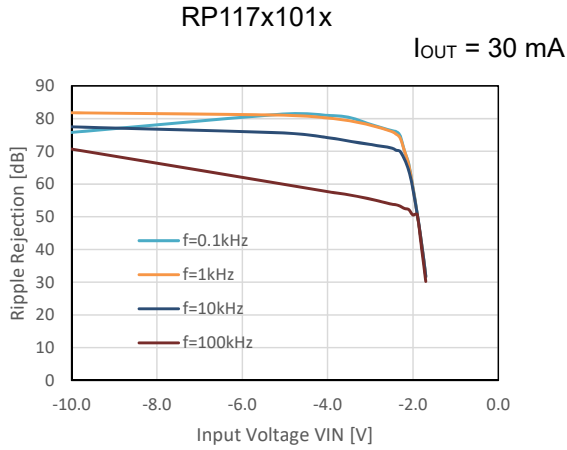

## 10) Output Noise vs. Ambient Temperature ( $C_{IN}$ = Ceramic 1.0 $\mu$ F, $C_{OUT}$ = Ceramic 2.2 $\mu$ F)

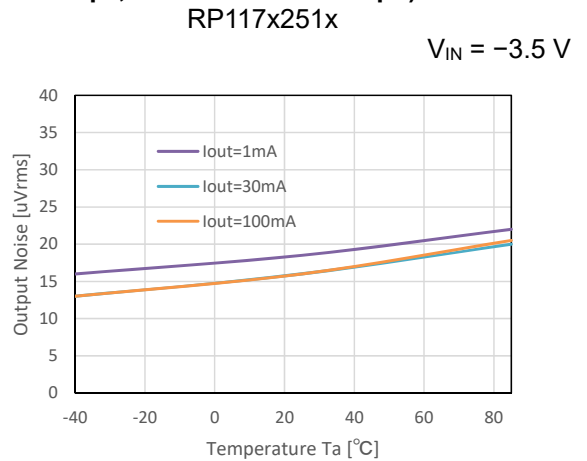
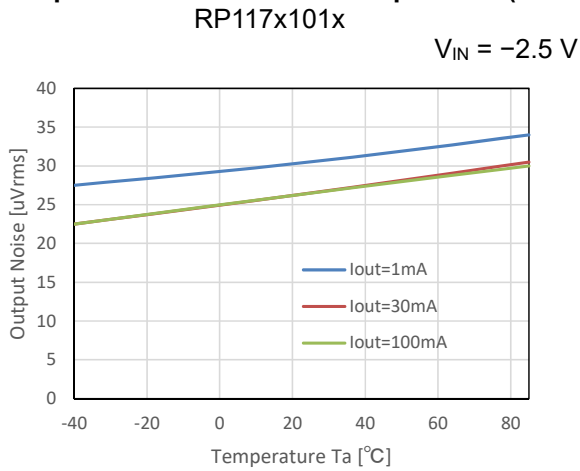

RP117x551x

$V_{IN} = -6.5\text{ V}$

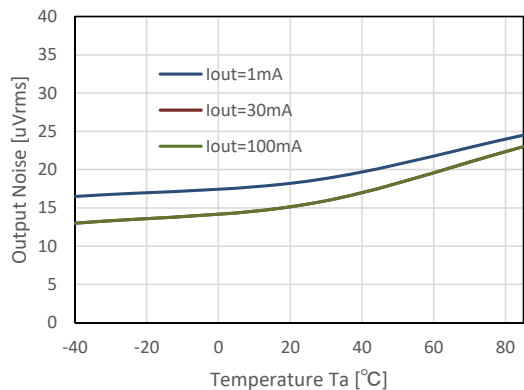

11) Output Noise vs. Frequency ( $C_{IN} = \text{Ceramic } 1.0\ \mu\text{F}$ ,  $C_{OUT} = \text{Ceramic } 2.2\ \mu\text{F}$ ,  $T_a = 25^\circ\text{C}$ )

RP117x101x

$V_{IN} = -2.5\text{ V}$

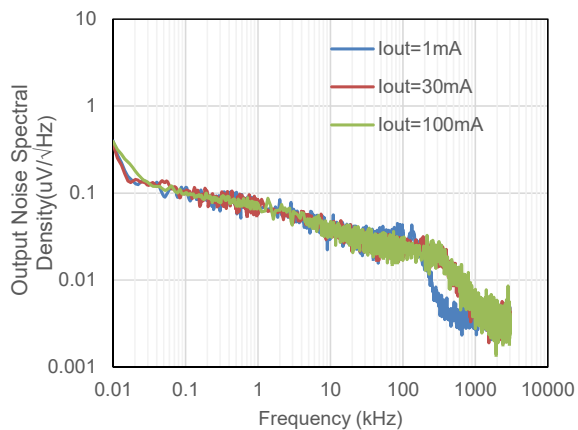

RP117x251x

$V_{IN} = -3.5\text{ V}$

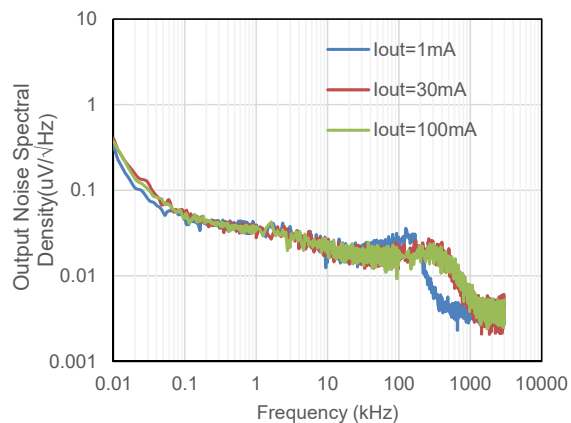

RP117x551x

$V_{IN} = -6.5\text{ V}$

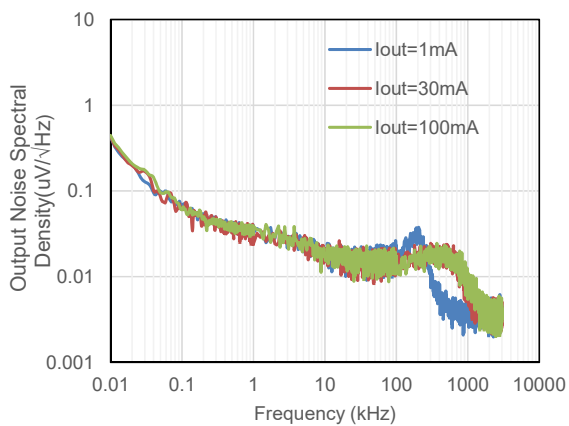

# RP117x

No. EA-379-181207

## 12) Input Transient Response ( $C_{IN} = \text{Ceramic } 1.0 \mu\text{F}$ , $C_{OUT} = \text{Ceramic } 2.2 \mu\text{F}$ , $t_r = t_f = 10 \mu\text{s}$ , $T_a = 25^\circ\text{C}$ )

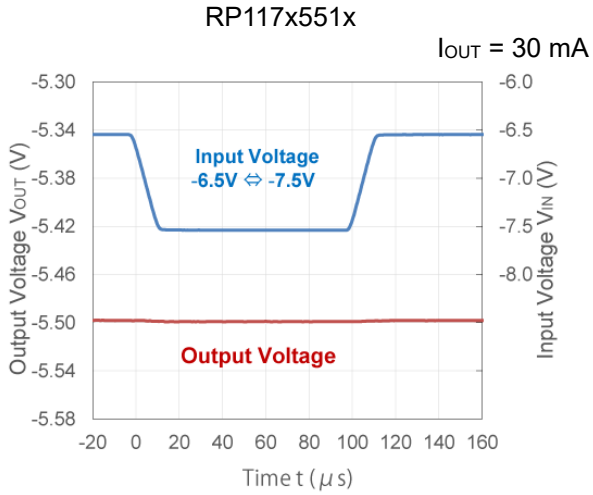
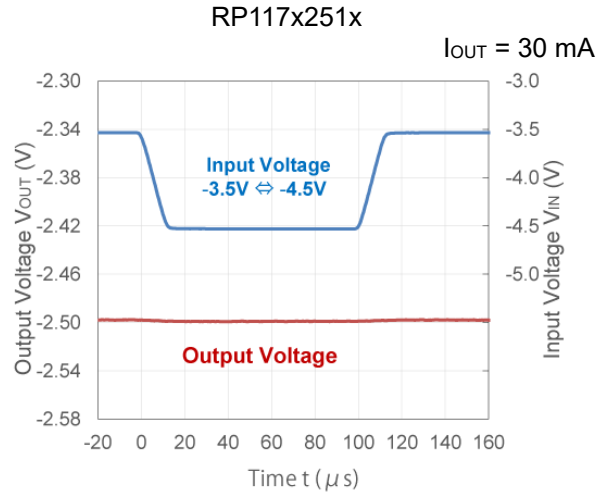
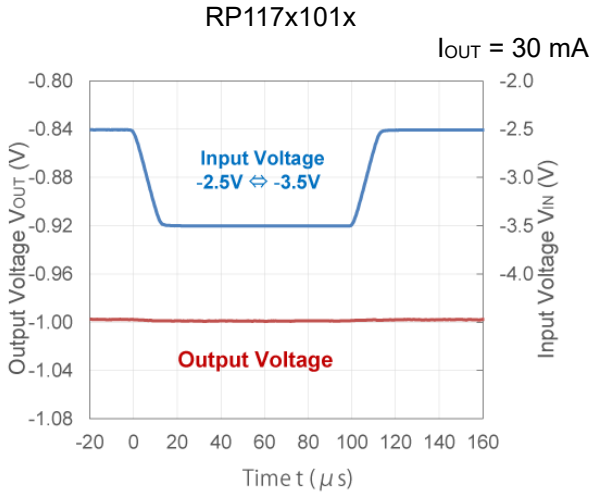

## 13) Load Transient Response ( $C_{IN} = \text{Ceramic } 1.0 \mu\text{F}$ , $C_{OUT} = \text{Ceramic } 2.2 \mu\text{F}$ , $t_r = t_f = 0.5 \mu\text{s}$ , $T_a = 25^\circ\text{C}$ )

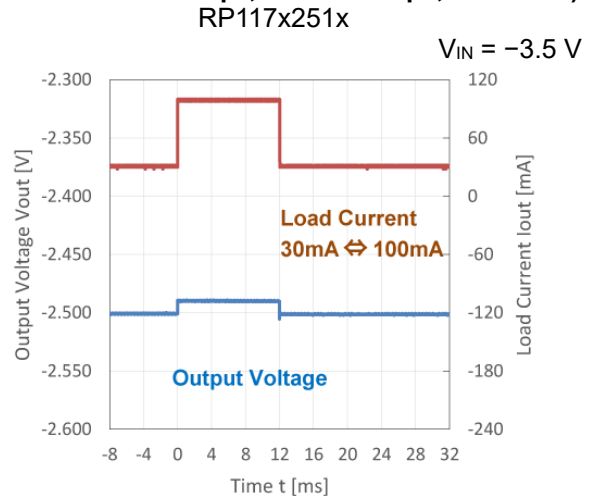
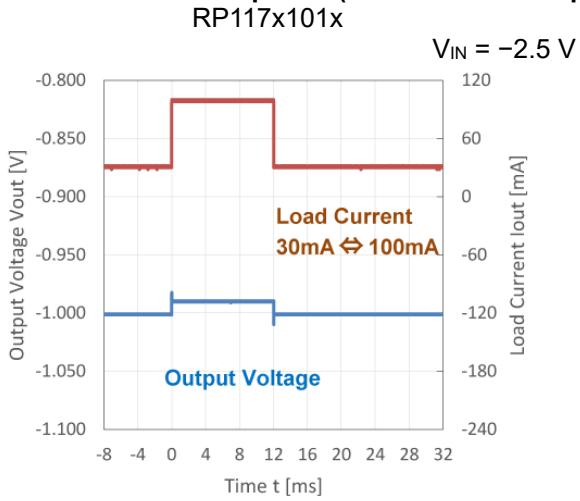



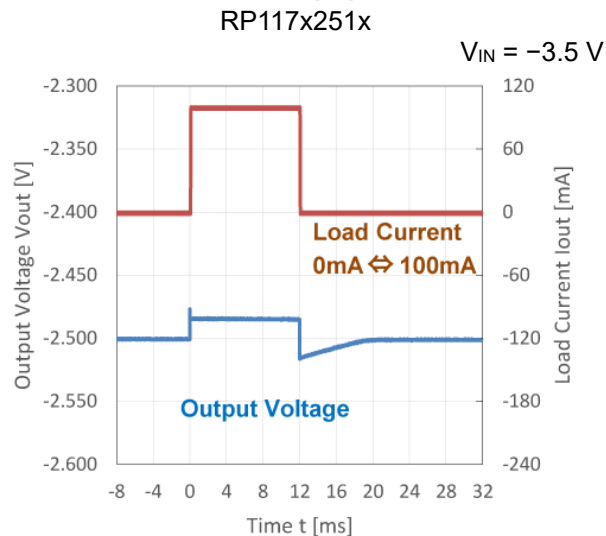
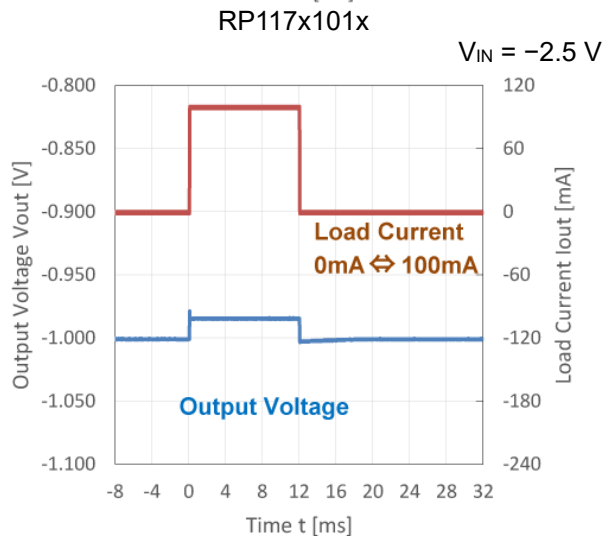
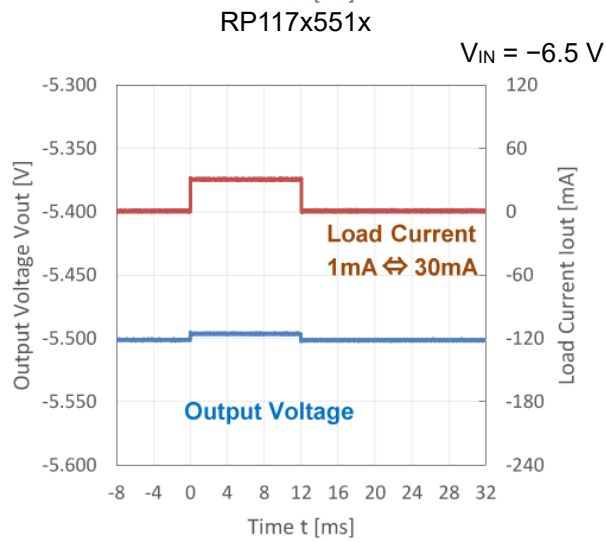
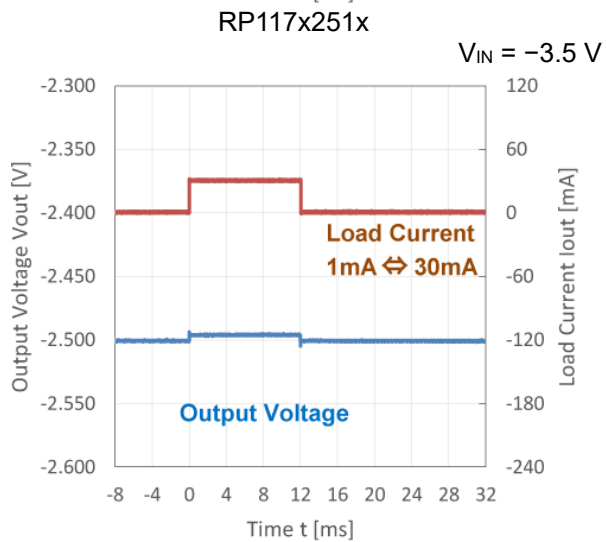
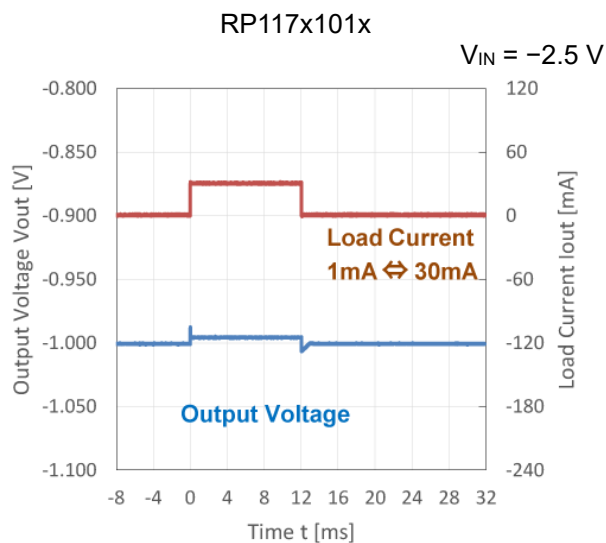
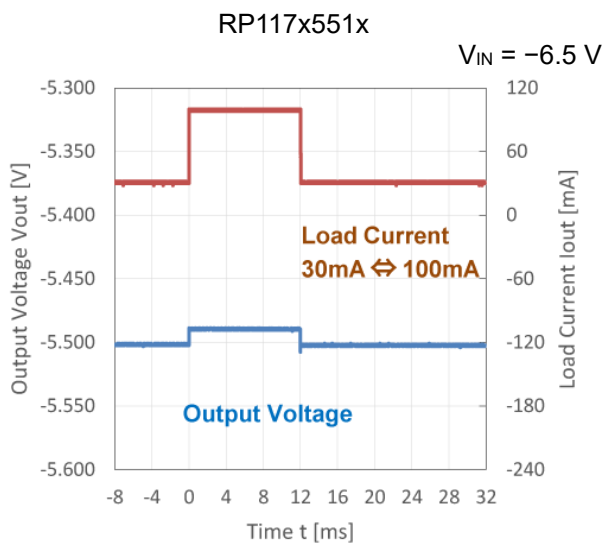

# RP117x

No. EA-379-181207

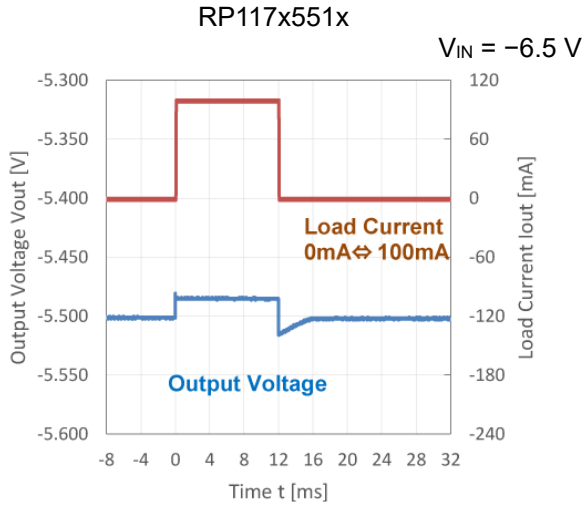

## 14) CE Pin Start-up Time ( $C_{IN} = \text{Ceramic } 1.0\ \mu\text{F}$ , $C_{OUT} = \text{Ceramic } 2.2\ \mu\text{F}$ , $t_r = t_f = 0.5\ \mu\text{s}$ , $T_a = 25^\circ\text{C}$ )

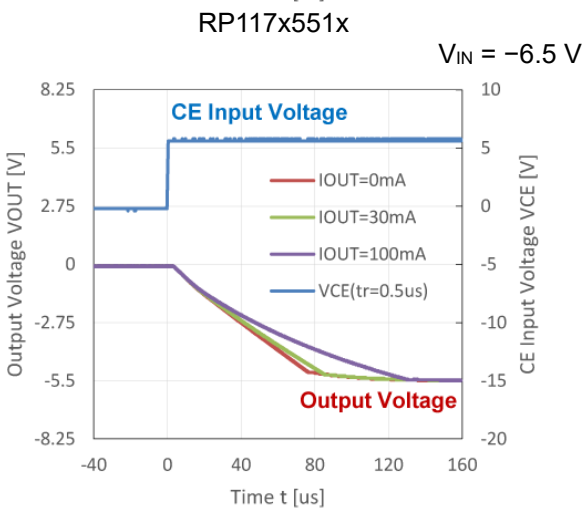
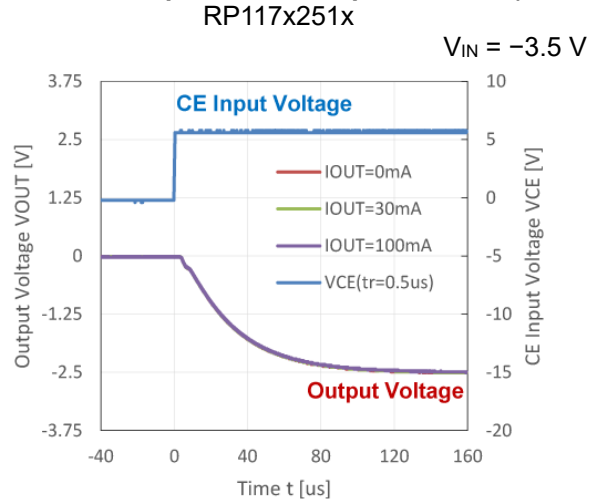
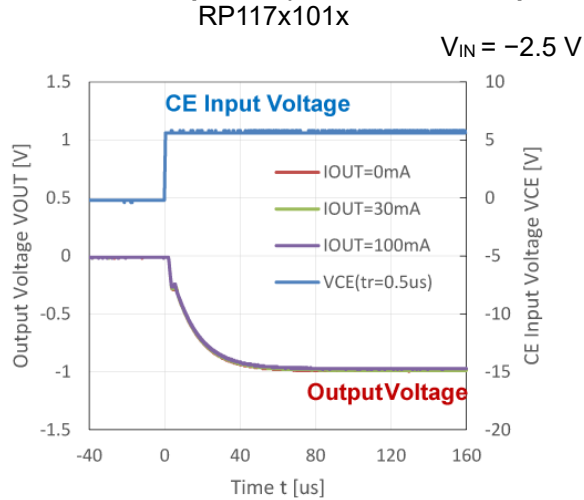

**15) CE Pin Shutdown Time ( $C_{IN}$  = Ceramic 1.0  $\mu$ F,  $C_{OUT}$  = Ceramic 2.2  $\mu$ F,  $t_r = t_f = 0.5 \mu$ s,  $T_a = 25^\circ$ C)**

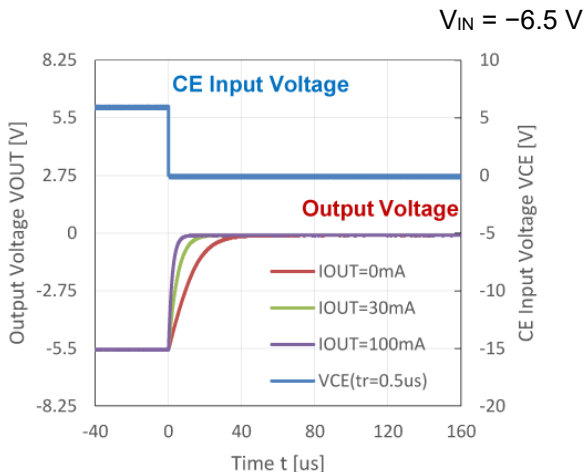
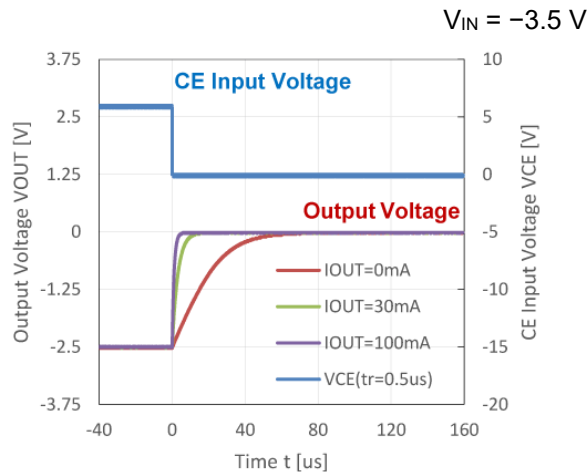
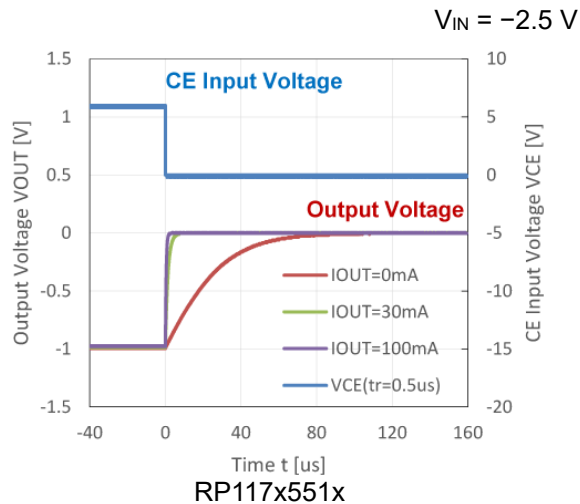

**16) Inrush Current ( $C_{IN}$  = Ceramic 1.0  $\mu$ F,  $C_{OUT}$  = Ceramic 2.2  $\mu$ F,  $t_r = t_f = 0.5 \mu$ s,  $T_a = 25^\circ$ C)**

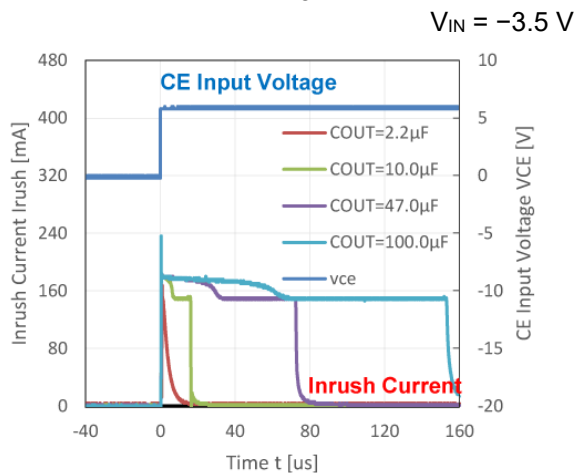
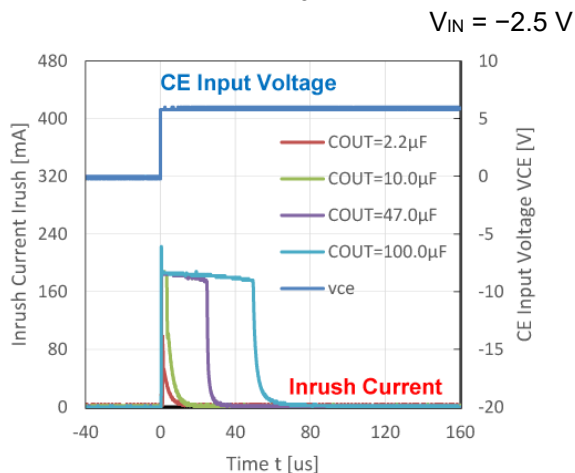

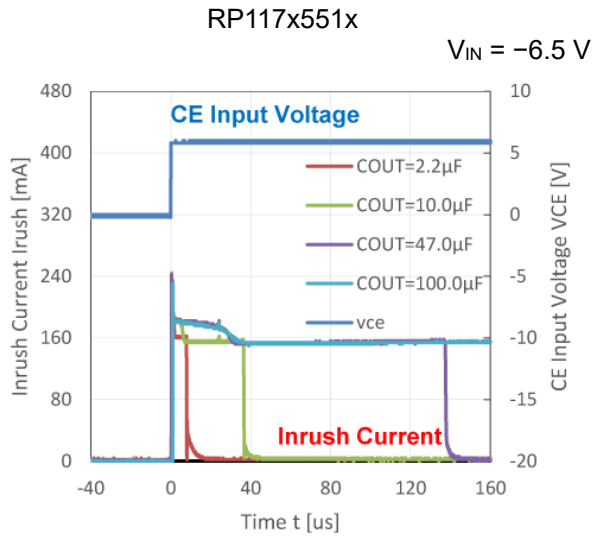

## Equivalent Series Resistance (ESR) vs. Output Current

It is recommended that a ceramic type capacitor be used for this device. However, other types of capacitors having lower ESR can also be used. The relation between the output current ( $I_{OUT}$ ) and the ESR of output capacitor is shown below.

### Measurement Conditions

Frequency Band: 10 Hz to 2 MHz

Ambient Temperature:  $-40^{\circ}\text{C}$  to  $85^{\circ}\text{C}$

Input Capacitor ( $C_{IN}$ ): Ceramic,  $1.0\ \mu\text{F}$

Output Capacitor ( $C_{OUT}$ ): Ceramic,  $2.2\ \mu\text{F}$

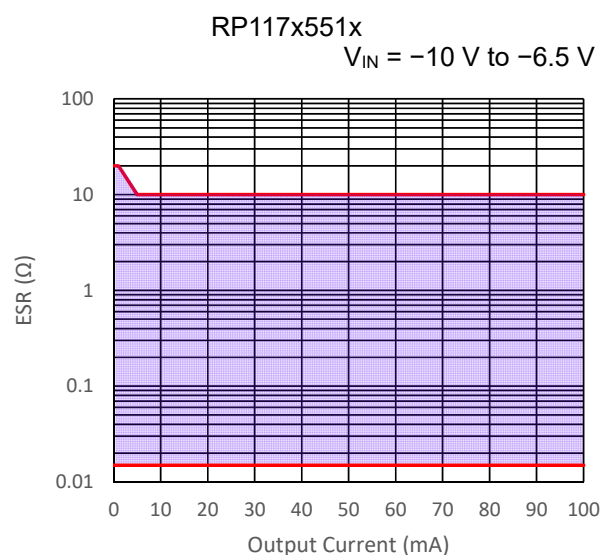
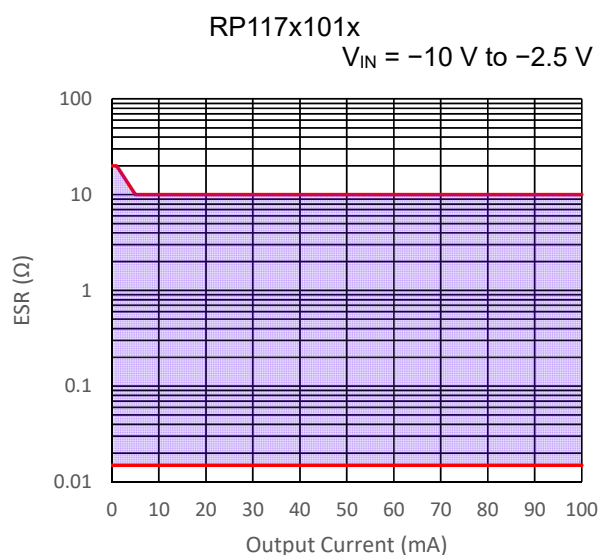

The power dissipation of the package is dependent on PCB material, layout, and environmental conditions. The following measurement conditions are based on JEDEC STD. 51-7.

**Measurement Conditions**

Item	Measurement Conditions
Environment	Mounting on Board (Wind Velocity = 0 m/s)
Board Material	Glass Cloth Epoxy Plastic (Four-Layer Board)
Board Dimensions	76.2 mm × 114.3 mm × 0.8 mm
Copper Ratio	Outer Layer (First Layer): Less than 95% of 50 mm Square Inner Layers (Second and Third Layers): Approx. 100% of 50 mm Square Outer Layer (Fourth Layer): Approx. 100% of 50 mm Square
Through-holes	φ 0.2 mm × 14 pcs

**Measurement Result**

(Ta = 25°C, Tjmax = 125°C)

Item	Measurement Result
Power Dissipation	450 mW
Thermal Resistance ( $\theta_{ja}$ )	$\theta_{ja} = 218^{\circ}\text{C/W}$
Thermal Characterization Parameter ( $\psi_{jt}$ )	$\psi_{jt} = 105^{\circ}\text{C/W}$

$\theta_{ja}$ : Junction-to-Ambient Thermal Resistance

$\psi_{jt}$ : Junction-to-Top Thermal Characterization Parameter

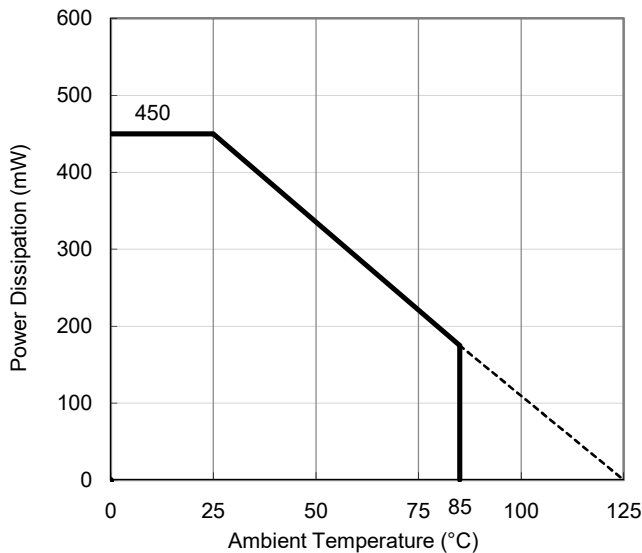

**Power Dissipation vs. Ambient Temperature**

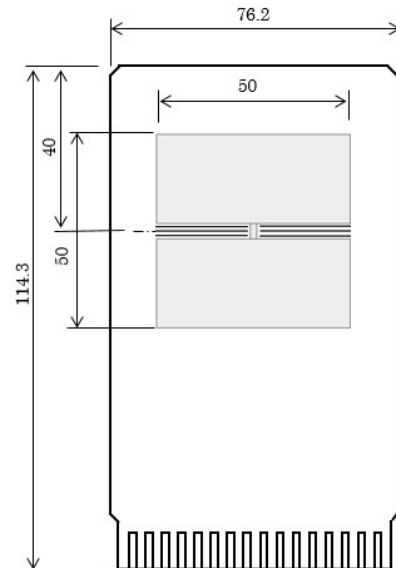

**Measurement Board Pattern**

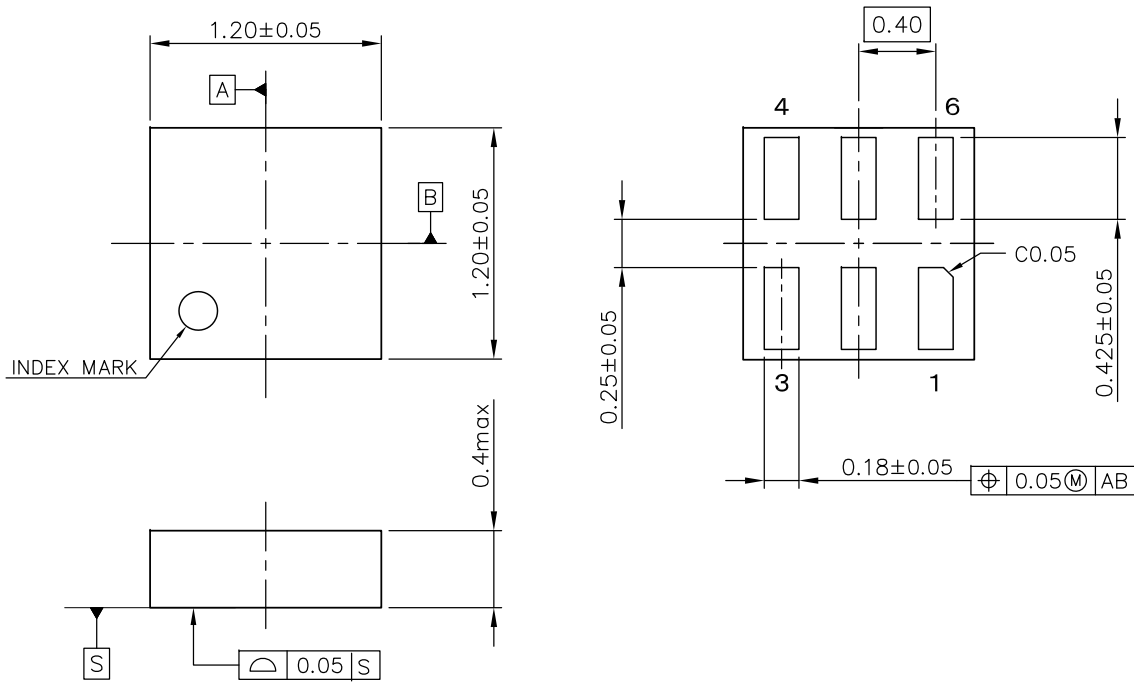

UNIT: mm

DFN(PLP)1212-6 Package Dimensions

The power dissipation of the package is dependent on PCB material, layout, and environmental conditions. The following conditions are used in this measurement.

**Measurement Conditions**

	<b>Standard Test Land Pattern</b>
Environment	Mounting on Board (Wind Velocity = 0 m/s)
Board Material	Glass Cloth Epoxy Plastic (Double-Sided Board)
Board Dimensions	40 mm × 40 mm × 1.6 mm
Copper Ratio	Top Side: Approx. 50% Bottom Side: Approx. 50%
Through-holes	φ 0.5 mm × 44 pcs

**Measurement Result**

(Ta = 25°C, Tjmax = 125°C)

	<b>Standard Test Land Pattern</b>	<b>Free Air</b>
Power Dissipation	380 mW	150 mW
Thermal Resistance	$\theta_{ja} = (125 - 25^\circ\text{C}) / 0.38\text{W} = 263^\circ\text{C/W}$ $\theta_{ja} = 75^\circ\text{C/W}$	$\theta_{ja} = (125 - 25^\circ\text{C}) / 0.15\text{W} = 667^\circ\text{C/W}$ -

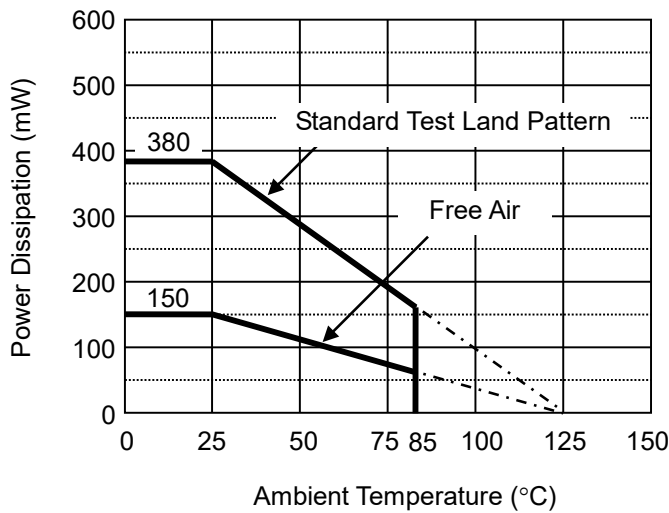

**Power Dissipation vs. Ambient Temperature**

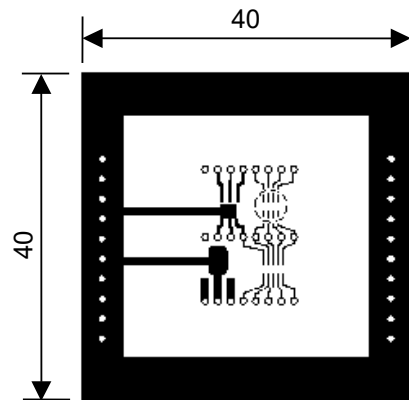

○ IC Mount Area (mm)

**Measurement Board Pattern**



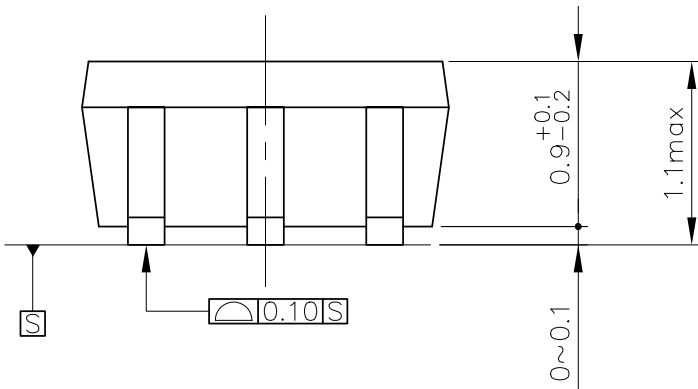
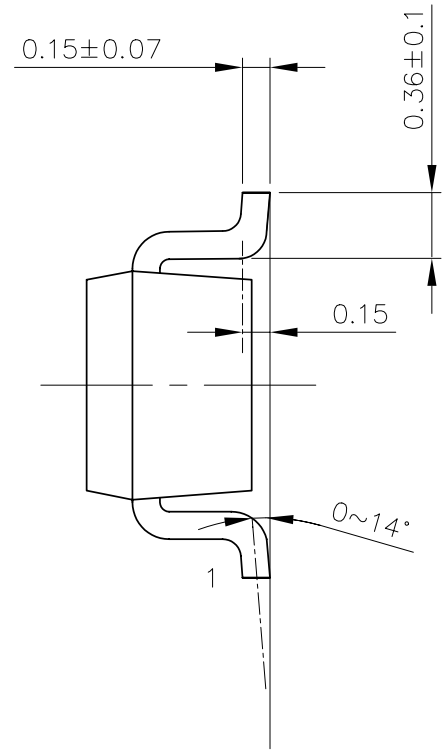
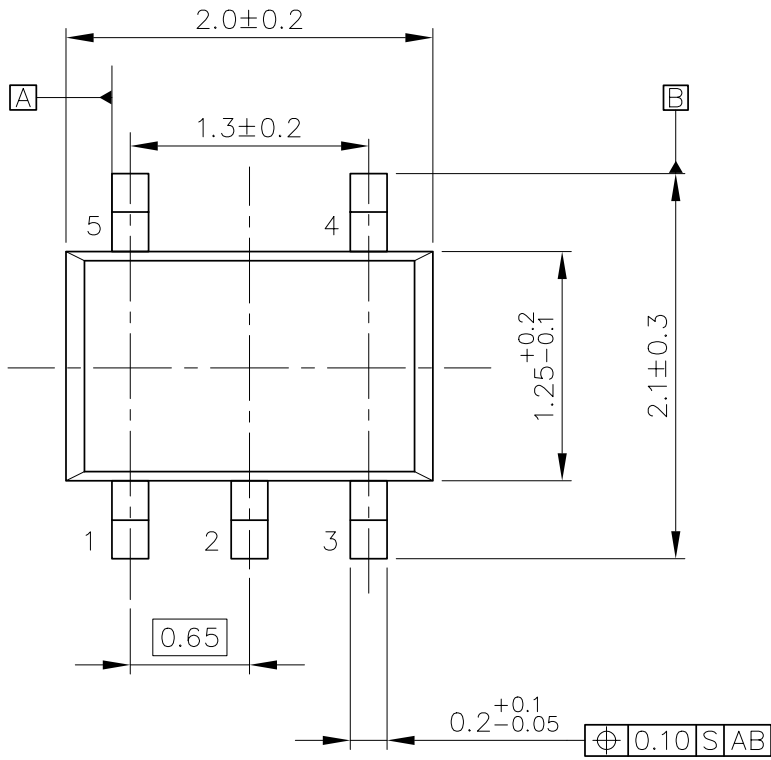

UNIT: mm

SC-88A Package Dimensions



1. The products and the product specifications described in this document are subject to change or discontinuation of production without notice for reasons such as improvement. Therefore, before deciding to use the products, please refer to Ricoh sales representatives for the latest information thereon.
2. The materials in this document may not be copied or otherwise reproduced in whole or in part without prior written consent of Ricoh.
3. Please be sure to take any necessary formalities under relevant laws or regulations before exporting or otherwise taking out of your country the products or the technical information described herein.
4. The technical information described in this document shows typical characteristics of and example application circuits for the products. The release of such information is not to be construed as a warranty of or a grant of license under Ricoh's or any third party's intellectual property rights or any other rights.
5. The products listed in this document are intended and designed for use as general electronic components in standard applications (office equipment, telecommunication equipment, measuring instruments, consumer electronic products, amusement equipment etc.). Those customers intending to use a product in an application requiring extreme quality and reliability, for example, in a highly specific application where the failure or misoperation of the product could result in human injury or death (aircraft, spacevehicle, nuclear reactor control system, traffic control system, automotive and transportation equipment, combustion equipment, safety devices, life support system etc.) should first contact us.
6. We are making our continuous effort to improve the quality and reliability of our products, but semiconductor products are likely to fail with certain probability. In order to prevent any injury to persons or damages to property resulting from such failure, customers should be careful enough to incorporate safety measures in their design, such as redundancy feature, fire containment feature and fail-safe feature. We do not assume any liability or responsibility for any loss or damage arising from misuse or inappropriate use of the products.
7. Anti-radiation design is not implemented in the products described in this document.
8. The X-ray exposure can influence functions and characteristics of the products. Confirm the product functions and characteristics in the evaluation stage.
9. WLCSP products should be used in light shielded environments. The light exposure can influence functions and characteristics of the products under operation or storage.
10. There can be variation in the marking when different AOI (Automated Optical Inspection) equipment is used. In the case of recognizing the marking characteristic with AOI, please contact Ricoh sales or our distributor before attempting to use AOI.
11. Please contact Ricoh sales representatives should you have any questions or comments concerning the products or the technical information.



**Ricoh is committed to reducing the environmental loading materials in electrical devices with a view to contributing to the protection of human health and the environment.**

Ricoh has been providing RoHS compliant products since April 1, 2006 and Halogen-free products since April 1, 2012.

**RICOH** RICOH ELECTRONIC DEVICES CO., LTD.

<https://www.e-devices.ricoh.co.jp/en/>

#### Sales & Support Offices

##### **Ricoh Electronic Devices Co., Ltd.**

##### **Shin-Yokohama Office (International Sales)**

2-3, Shin-Yokohama 3-chome, Kohoku-ku, Yokohama-shi, Kanagawa, 222-8530, Japan  
Phone: +81-50-3814-7687 Fax: +81-45-474-0074

##### **Ricoh Americas Holdings, Inc.**

675 Campbell Technology Parkway, Suite 200 Campbell, CA 95008, U.S.A.  
Phone: +1-408-610-3105

##### **Ricoh Europe (Netherlands) B.V.**

##### **Semiconductor Support Centre**

Prof. W.H. Keesomlaan 1, 1183 DJ Amstelveen, The Netherlands  
Phone: +31-20-5474-309

##### **Ricoh International B.V. - German Branch**

##### **Semiconductor Sales and Support Centre**

Oberrather Strasse 6, 40472 Düsseldorf, Germany  
Phone: +49-211-6546-0

##### **Ricoh Electronic Devices Korea Co., Ltd.**

3F, Haesung Bldg, 504, Teheran-ro, Gangnam-gu, Seoul, 135-725, Korea  
Phone: +82-2-2135-5700 Fax: +82-2-2051-5713

##### **Ricoh Electronic Devices Shanghai Co., Ltd.**

Room 403, No.2 Building, No.690 Bibo Road, Pu Dong New District, Shanghai 201203,  
People's Republic of China  
Phone: +86-21-5027-3200 Fax: +86-21-5027-3299

##### **Ricoh Electronic Devices Shanghai Co., Ltd.**

##### **Shenzhen Branch**

1205, Block D (Jinlong Building), Kingkey 100, Hongbao Road, Luohu District,  
Shenzhen, China  
Phone: +86-755-8348-7600 Ext 225

##### **Ricoh Electronic Devices Co., Ltd.**

##### **Taipei office**

Room 109, 10F-1, No.51, Hengyang Rd., Taipei City, Taiwan  
Phone: +886-2-2313-1621/1622 Fax: +886-2-2313-1623

# Mouser Electronics

Authorized Distributor

Click to View Pricing, Inventory, Delivery & Lifecycle Information:

[Ricoch Electronics:](#)

[RP117K111D-TR](#) [RP117K121D-TR](#) [RP117K131D-TR](#) [RP117K151D-TR](#) [RP117K311D-TR](#) [RP117Q252D-TR-FE](#)



Компания «ЭлектроПласт» предлагает заключение долгосрочных отношений при поставках импортных электронных компонентов на взаимовыгодных условиях!

Наши преимущества:

- Оперативные поставки широкого спектра электронных компонентов отечественного и импортного производства напрямую от производителей и с крупнейших мировых складов;
- Поставка более 17-ти миллионов наименований электронных компонентов;
- Поставка сложных, дефицитных, либо снятых с производства позиций;
- Оперативные сроки поставки под заказ (от 5 рабочих дней);
- Экспресс доставка в любую точку России;
- Техническая поддержка проекта, помощь в подборе аналогов, поставка прототипов;
- Система менеджмента качества сертифицирована по Международному стандарту ISO 9001;
- Лицензия ФСБ на осуществление работ с использованием сведений, составляющих государственную тайну;
- Поставка специализированных компонентов (Xilinx, Altera, Analog Devices, Intersil, Interpoint, Microsemi, Aeroflex, Peregrine, Syfer, Eurofarad, Texas Instrument, Miteq, Cobham, E2V, MA-COM, Hittite, Mini-Circuits, General Dynamics и др.);

Помимо этого, одним из направлений компании «ЭлектроПласт» является направление «Источники питания». Мы предлагаем Вам помощь Конструкторского отдела:

- Подбор оптимального решения, техническое обоснование при выборе компонента;
- Подбор аналогов;
- Консультации по применению компонента;
- Поставка образцов и прототипов;
- Техническая поддержка проекта;
- Защита от снятия компонента с производства.



#### Как с нами связаться

**Телефон:** 8 (812) 309 58 32 (многоканальный)

**Факс:** 8 (812) 320-02-42

**Электронная почта:** [org@eplast1.ru](mailto:org@eplast1.ru)

**Адрес:** 198099, г. Санкт-Петербург, ул. Калинина, дом 2, корпус 4, литера А.