



Thin Film Platinum RTDs
HEL-700 Series



Thin Film Platinum RTDs

The HEL-700 Series Thin Film Platinum RTDs (Resistance Temperature Detectors) are designed to monitor or control critical temperatures in industrial applications. They provide a linear change in resistance versus temperature, combining high linearity, stability, accuracy, and wide temperature range in a small, fast-response package.

The HEL-700 Series is designed to measure temperatures from -75 °C to 540 °C [-100 °F to 1000 °F] with high accuracy. These fully-assembled elements are ready-to-use in probe assemblies, without the need for fragile splices to extension leads.

These products are manufactured using a thin layer of platinum deposited on an alumina substrate and are laser trimmed to a resistance interchangeability of a standard $\pm 0.2\%$ (± 0.5 °C accuracy) or optional $\pm 0.1\%$ (± 0.3 °C accuracy). The sensor chip is then glassed, wired and potted or ceramic fired to result in a cylindrical alumina package with either TFE Teflon®- or fiberglass-insulated lead wires.

Key Features

- Wide temperature range
- Interchangeable
- Accurate
- Linear resistance vs temperature
- Fast response
- Laser trimmed
- Ceramic case material
- TFE Teflon® or fiberglass leadwires
- Multiple small sizes
- Ready-to-use, fully assembled elements

Potential Applications

Temperature sensing for monitoring, compensation and regulation in:

INDUSTRIAL

- HVAC equipment
- Instrument and probe assemblies
- Process control
- Motor windings and bearings
- Battery packs
- Environmental chambers
- Ovens and kilns
- Drill holes in large objects

MEDICAL

- Autoclaves

AEROSPACE/DEFENSE

- Aircraft
- Space vehicles

WIDE TEMPERATURE RANGE • INTERCHANGEABLE • ACCURATE

Thin Film Platinum RTDs, HEL-700 Series

Table 1. Specifications

Characteristic	Condition	Parameter
Alpha: R ₀ = 1000 Ω R ₀ = 100 Ω	0 °C	0.00375 Ω/Ω/°C 0.00385 Ω/Ω/°C
Temperature range: TFE Teflon fiberglass	—	-70 °C to 260 °C [-94 °F to 500 °F] -75 °C to 540 °C [-100 °F to 1000 °F]
Temperature accuracy: R ₀ ±0.2% trim (standard) R ₀ ±0.1% trim (optional)	—	±0.5°C or 0.8% of temperature, whichever is greater ±0.3°C or 0.6% of temperature, whichever is greater
Base resistance and interchangeability, R ₀ ±ΔR ₀ : R ₀ ±0.2% trim (standard) R ₀ ±0.1% trim (optional)	0 °C	1000 Ω ±2 Ω 1000 Ω ±1 Ω
Linearity: -40 °C to 125 °C -75 °C to 540 °C	—	±0.1% of full scale ±2.0% of full scale
Time constant	water at 3 ft/s still water	<0.5 s for 0.086 in O.D. <1.0 s for 0.086 in O.D.
Operating current	—	2 mA max. minimal self heating errors of 1 °C; 1 mA recommended
Stability	occupied environments	<0.25 °C /year; 0.05 °C /5 years
Self heating	—	<15 mW/°C typ. for 0.086 in O.D.
Insulation resistance	50 Vdc at 25 °C	>50 MΩ
Construction/material: case Teflon®-insulated leads fiberglass-insulated leads	—	high purity alumina nickel-coated stranded copper, epoxy potting nickel-coated stranded copper, ceramic potting

Table 2. Constant Values (β = 0 and C = 0 for T > 0 °C)

Constant	1000 Ω	100 Ω	Functional Behavior
Alpha α (°C ⁻¹)	0.00375 ±0.000029	0.003850 ±0.000010	$R_T = R_0(1 + AT + BT^2 - 100CT^3 + CT^4)$ Where: R _T = Resistance (Ω) at temperature T (°C) R ₀ = Resistance (Ω) at 0 °C T = Temperature (°C) $A = \alpha + \frac{\alpha\delta}{100}$ $B = -\frac{\alpha\delta}{100^2}$ $C_{T<0} = -\frac{\alpha\beta}{100^4}$
Delta δ (°C)	1.605 ±0.009	1.4999 ±0.007	
Beta β (°C)	0.16	0.10863	
A (°C ⁻¹)	3.81 x 10 ⁻³	3.908 x 10 ⁻³	
B (°C ⁻²)	-6.02 x 10 ⁻⁷	-5.775 x 10 ⁻⁷	
C (°C ⁻⁴)	-6.0 x 10 ⁻¹²	-4.183 x 10 ⁻¹²	

CAUTION PRODUCT DAMAGE

- Ensure proper ESD (Electrostatic Discharge) precautions are followed when handling this product.

Failure to comply with these instructions may result in product damage.

Thin Film Platinum RTDs, HEL-700 Series

Table 3. Accuracy vs Temperature

Temperature (°C)	Tolerance			
	Standard Trim (±0.2%)		Optional Trim (±0.1%)	
	±ΔR ¹ (Ω)	±ΔT (°C)	±ΔR ¹ (Ω)	±ΔT (°C)
-100	2.9	0.8	2.4	0.6
0	2.0	0.5	1.0	0.3
100	2.9	0.8	2.2	0.6
200	5.6	1.6	4.3	1.2
300	8.2	2.4	6.2	1.8
400	11.0	3.2	8.3	2.5
500	12.5	4.0	9.6	3.0
600	15.1	4.8	10.4	3.3

¹1000 Ω RTD. Divide Δ by 10 for 100 Ω RTD.

Table 4. NIST Calibration

Temperature (°C)	Standard Temperature Point (±ΔT (°C))		
	1	2	3
-100	0.5	0.27	0.15
0	0.03	0.03	0.03
100	0.4	0.11	0.07
200	0.8	0.02	0.08
300	1.2	0.33	6.2
400	1.6	0.5	8.3
500	2.0	0.8	9.6
600	2.6	1.2	10.4

¹NIST-traceable calibration provides resistance readings at 1, 2 or 3 standard temperature points to yield a resistance versus temperature curve with 10x better accuracy.

Figure 1. Resistance vs Temperature



Figure 2. Nomenclature and Ordering Guide

For example, a **HEL-705-U-0-12-C1** part number defines an HEL-700 Series Thin Film RTD with two, 28 gauge TFE Teflon[®] insulated leadwires, an alpha of 1000 Ω: 0.00375 Ω/Ω/°C, a standard ±0.2% trim resistance, 12 inch leadwires, and a NIST calibration report at 0 °C.

HEL-	705-	U-	0-	12-	C1
Product Series	Leadwire Insulation Material, Gauge and Number	Resistance and Alpha	Resistance Trim	Leadwire Length	NIST Calibration Report
HEL-700 Series Thin Film Platinum RTDs	705 TFE Teflon [®] , 28 gauge; 1000 Ω: 2-wire, 100 Ω: 2-wire	U 1000 Ω: 0.00375 Ω/Ω/°C	0 Standard: ±0.2%	12 12 inches	00 none
	707 fiberglass, 28 gauge; 1000 Ω: 2-wire, 100 Ω: 2-wire	T 100 Ω: 0.00385 Ω/Ω/°C (DIN Standard)	1 Optional: ±0.1%		C1 at 0 °C
	711 TFE Teflon [®] , 28 gauge; 1000 Ω: 2-wire, 100 Ω: 3-wire				C2 at 0 °C and 100 °C
	712 fiberglass, 28 gauge; 1000 Ω: 2-wire, 100 Ω: 3-wire				C3 at 0 °C, 100 °C and 260 °C
	716 TFE Teflon [®] , 24 gauge; 1000 Ω: 2-wire, 100 Ω: 3-wire				
	717 fiberglass, 24 gauge; 1000 Ω: 2-wire, 100 Ω: 3-wire				

Thin Film Platinum RTDs, HEL-700 Series

Figure 3. All Available Standard Configurations





Teflon®-Insulated Leadwires		Fiberglass-Insulated Leadwires	
HEL-705		HEL-707	
HEL-711		HEL-712	
HEL-716		HEL-717	

Figure 4. Dimensional Drawings (For reference only: mm [in].)

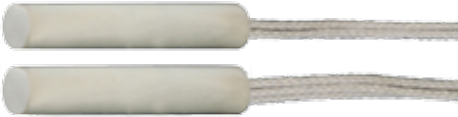

Thin Film Platinum RTDs, HEL-700 Series

Figure 5. Circuits

Wheatstone Bridge 2-Wire Interface



Linear Output Voltage

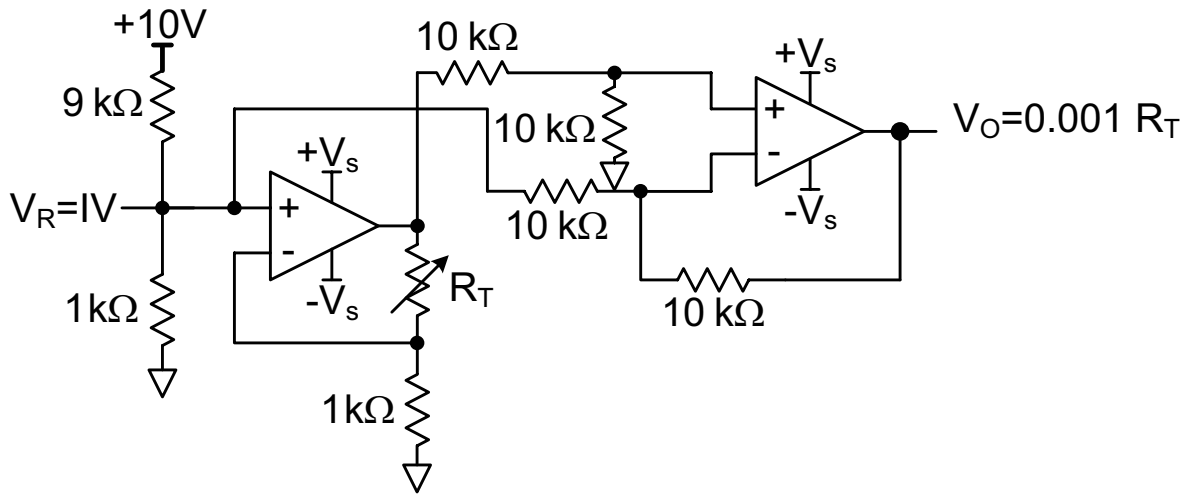

Adjustable Point (Comparator) Interface



ADDITIONAL INFORMATION

The following associated literature is available at sensing.honeywell.com:

- Temperature Sensors Line Guide
- Thermal Sensors Range Guide

⚠ WARNING **PERSONAL INJURY**

DO NOT USE these products as safety or emergency stop devices or in any other application where failure of the product could result in personal injury.

Failure to comply with these instructions could result in death or serious injury.

⚠ WARNING **MISUSE OF DOCUMENTATION**

- The information presented in this product sheet is for reference only. Do not use this document as a product installation guide.
- Complete installation, operation, and maintenance information is provided in the instructions supplied with each product.

Failure to comply with these instructions could result in death or serious injury.

Sales and Service

Honeywell serves its customers through a worldwide network of sales offices, representatives and distributors. For application assistance, current specifications, pricing or name of the nearest Authorized Distributor, contact your local sales office or email us at info.sc@honeywell.com. Visit us on the Web at sensing.honeywell.com

Phone and Fax:

Asia Pacific	+65 6355-2828 +65 6445-3033 Fax
Europe	+44 (0) 1698 481481 +44 (0) 1698 481676 Fax
Latin America	+1-305-805-8188 +1-305-883-8257 Fax
USA/Canada	+1-800-537-6945 +1-815-235-6847 +1-815-235-6545 Fax

Sensing and Control
Honeywell
1985 Douglas Drive North
Golden Valley, MN 55422
honeywell.com

WARRANTY/REMEDY

Honeywell warrants goods of its manufacture as being free of defective materials and faulty workmanship. Honeywell's standard product warranty applies unless agreed to otherwise by Honeywell in writing; please refer to your order acknowledgement or consult your local sales office for specific warranty details. If warranted goods are returned to Honeywell during the period of coverage, Honeywell will repair or replace, at its option, without charge those items it finds defective. **The foregoing is buyer's sole remedy and is in lieu of all other warranties, expressed or implied, including those of merchantability and fitness for a particular purpose. In no event shall Honeywell be liable for consequential, special, or indirect damages.**

While we provide application assistance personally, through our literature and the Honeywell website, it is up to the customer to determine the suitability of the product in the application.

Specifications may change without notice. The information we supply is believed to be accurate and reliable as of this printing. However, we assume no responsibility for its use.

Honeywell



Компания «ЭлектроПласт» предлагает заключение долгосрочных отношений при поставках импортных электронных компонентов на взаимовыгодных условиях!

Наши преимущества:

- Оперативные поставки широкого спектра электронных компонентов отечественного и импортного производства напрямую от производителей и с крупнейших мировых складов;
- Поставка более 17-ти миллионов наименований электронных компонентов;
- Поставка сложных, дефицитных, либо снятых с производства позиций;
- Оперативные сроки поставки под заказ (от 5 рабочих дней);
- Экспресс доставка в любую точку России;
- Техническая поддержка проекта, помощь в подборе аналогов, поставка прототипов;
- Система менеджмента качества сертифицирована по Международному стандарту ISO 9001;
- Лицензия ФСБ на осуществление работ с использованием сведений, составляющих государственную тайну;
- Поставка специализированных компонентов (Xilinx, Altera, Analog Devices, Intersil, Interpoint, Microsemi, Aeroflex, Peregrine, Syfer, Eurofarad, Texas Instrument, Miteq, Cobham, E2V, MA-COM, Hittite, Mini-Circuits, General Dynamics и др.);

Помимо этого, одним из направлений компании «ЭлектроПласт» является направление «Источники питания». Мы предлагаем Вам помощь Конструкторского отдела:

- Подбор оптимального решения, техническое обоснование при выборе компонента;
- Подбор аналогов;
- Консультации по применению компонента;
- Поставка образцов и прототипов;
- Техническая поддержка проекта;
- Защита от снятия компонента с производства.



Как с нами связаться

Телефон: 8 (812) 309 58 32 (многоканальный)

Факс: 8 (812) 320-02-42

Электронная почта: org@eplast1.ru

Адрес: 198099, г. Санкт-Петербург, ул. Калинина, дом 2, корпус 4, литера А.