



Is Now Part of



ON Semiconductor®

To learn more about ON Semiconductor, please visit our website at
www.onsemi.com

Please note: As part of the Fairchild Semiconductor integration, some of the Fairchild orderable part numbers will need to change in order to meet ON Semiconductor's system requirements. Since the ON Semiconductor product management systems do not have the ability to manage part nomenclature that utilizes an underscore (_), the underscore (_) in the Fairchild part numbers will be changed to a dash (-). This document may contain device numbers with an underscore (_). Please check the ON Semiconductor website to verify the updated device numbers. The most current and up-to-date ordering information can be found at www.onsemi.com. Please email any questions regarding the system integration to Fairchild_questions@onsemi.com.

ON Semiconductor and the ON Semiconductor logo are trademarks of Semiconductor Components Industries, LLC dba ON Semiconductor or its subsidiaries in the United States and/or other countries. ON Semiconductor owns the rights to a number of patents, trademarks, copyrights, trade secrets, and other intellectual property. A listing of ON Semiconductor's product/patent coverage may be accessed at www.onsemi.com/site/pdf/Patent-Marking.pdf. ON Semiconductor reserves the right to make changes without further notice to any products herein. ON Semiconductor makes no warranty, representation or guarantee regarding the suitability of its products for any particular purpose, nor does ON Semiconductor assume any liability arising out of the application or use of any product or circuit, and specifically disclaims any and all liability, including without limitation special, consequential or incidental damages. Buyer is responsible for its products and applications using ON Semiconductor products, including compliance with all laws, regulations and safety requirements or standards, regardless of any support or applications information provided by ON Semiconductor. "Typical" parameters which may be provided in ON Semiconductor data sheets and/or specifications can and do vary in different applications and actual performance may vary over time. All operating parameters, including "Typicals" must be validated for each customer application by customer's technical experts. ON Semiconductor does not convey any license under its patent rights nor the rights of others. ON Semiconductor products are not designed, intended, or authorized for use as a critical component in life support systems or any FDA Class 3 medical devices or medical devices with a same or similar classification in a foreign jurisdiction or any devices intended for implantation in the human body. Should Buyer purchase or use ON Semiconductor products for any such unintended or unauthorized application, Buyer shall indemnify and hold ON Semiconductor and its officers, employees, subsidiaries, affiliates, and distributors harmless against all claims, costs, damages, and expenses, and reasonable attorney fees arising out of, directly or indirectly, any claim of personal injury or death associated with such unintended or unauthorized use, even if such claim alleges that ON Semiconductor was negligent regarding the design or manufacture of the part. ON Semiconductor is an Equal Opportunity/Affirmative Action Employer. This literature is subject to all applicable copyright laws and is not for resale in any manner.

74VHC541 Octal Buffer/Line Driver with 3-STATE Outputs

General Description

The VHC541 is an advanced high-speed CMOS device fabricated with silicon gate CMOS technology. It achieves the high-speed operation similar to equivalent Bipolar Schottky TTL while maintaining the CMOS low power dissipation.

The VHC541 is an octal buffer/line driver designed to be employed as memory and address drivers, clock drivers and bus oriented transmitter/receivers.

This device is similar in function to the VHC244 while providing flow-through architecture (inputs on opposite side from outputs). This pinout arrangement makes this device especially useful as an output port for microprocessors, allowing ease of layout and greater PC board density.

An input protection circuit insures that 0V to 7V can be applied to the input pins without regard to the supply voltage. This device can be used to interface 5V to 3V systems and two supply systems such as battery backup. This circuit prevents device destruction due to mismatched supply and input voltages.

Features

- High Speed: $t_{PD} = 3.5 \text{ ns}$ (typ) at $V_{CC} = 5V$
- Low power dissipation: $I_{CC} = 4 \mu\text{A}$ (max) at $T_A = 25^\circ\text{C}$
- High noise immunity: $V_{NIH} = V_{NIL} = 28\% V_{CC}$ (min)
- Power down protection is provided on all inputs
- Low noise: $V_{OLP} = 0.9V$ (typ)
- Pin and function compatible with 74HC541

Ordering Code:

Order Number	Package Number	Package Description
74VHC541M	M20B	20-Lead Small Outline Integrated Circuit (SOIC), JEDEC MS-013, 0.300" Wide
74VHC541SJ	M20D	Pb-Free 20-Lead Small Outline Package (SOP), EIAJ TYPE II, 5.3mm Wide
74VHC541MTC	MTC20	20-Lead Thin Shrink Small Outline Package (TSSOP), JEDEC MO-153, 4.4mm Wide
74VHC541N	N20A	20-Lead Plastic Dual-In-Line Package (PDIP), JEDEC MS-001, 0.300" Wide

Surface mount packages are also available on Tape and Reel. Specify by appending the suffix letter "X" to the ordering code.
Pb-Free package per JEDEC J-STD-020B.

Connection Diagram

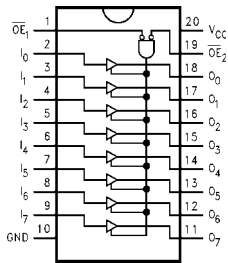

Logic Symbol

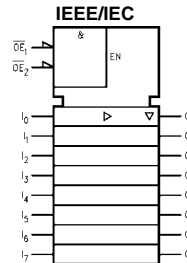

Pin Descriptions

Pin Names	Descriptions
$\overline{OE}_1, \overline{OE}_2$	3-STATE Output Enable Inputs
$I_0 - I_7$	Inputs
$O_0 - O_7$	3-STATE Outputs

Truth Table

Inputs			Outputs
\overline{OE}_1	\overline{OE}_2	I	
L	L	H	H
H	X	X	Z
X	H	X	Z
L	L	L	L

H = HIGH Voltage Level
L = LOW Voltage Level
X = Immaterial
Z = High Impedance

Absolute Maximum Ratings (Note 1)

Supply Voltage (V_{CC})	-0.5V to +7.0V
DC Input Voltage (V_{IN})	-0.5V to +7.0V
DC Output Voltage (V_{OUT})	-0.5V to $V_{CC} + 0.5V$
Input Diode Current (I_{IK})	-20 mA
Output Diode Current (I_{OK})	± 20 mA
DC Output Current (I_{OUT})	± 25 mA
DC V_{CC} /GND Current (I_{CC})	± 75 mA
Storage Temperature (T_{STG})	-65°C to +150°C
Lead Temperature (T_L) (Soldering, 10 seconds)	260°C

Recommended Operating Conditions (Note 2)

Supply Voltage (V_{CC})	2.0V to +5.5V
Input Voltage (V_{IN})	0V to +5.5V
Output Voltage (V_{OUT})	0V to V_{CC}
Operating Temperature (T_{OPR})	-40°C to +85°C
Input Rise and Fall Time (t_r, t_f)	
$V_{CC} = 3.3V \pm 0.3V$	0 ~ 100 ns/V
$V_{CC} = 5.0V \pm 0.5V$	0 ~ 20 ns/V

Note 1: Absolute Maximum Ratings are values beyond which the device may be damaged or have its useful life impaired. The databook specifications should be met, without exception, to ensure that the system design is reliable over its power supply, temperature, and output/input loading variables. Fairchild does not recommend operation outside databook specifications.

Note 2: Unused inputs must be held HIGH or LOW. They may not float

DC Electrical Characteristics

Symbol	Parameter	V_{CC} (V)	$T_A = 25^\circ\text{C}$			$T_A = -40^\circ\text{C to } +85^\circ\text{C}$		Units	Conditions	
			Min	Typ	Max	Min	Max			
V_{IH}	HIGH Level Input Voltage	2.0 3.0 – 5.5	1.50 0.7 V_{CC}			1.50 0.7 V_{CC}		V		
V_{IL}	LOW Level Input Voltage	2.0 3.0 – 5.5			0.50 0.3 V_{CC}	0.50 0.3 V_{CC}		V		
V_{OH}	HIGH Level Output Voltage	2.0	1.9	2.0		1.9		V	$V_{IN} = V_{IH}$ or V_{IL}	$I_{OH} = -50 \mu\text{A}$
		3.0	2.9	3.0		2.9				
		4.5	4.4	4.5		4.4		V		$I_{OH} = -4 \text{ mA}$ $I_{OH} = -8 \text{ mA}$
		3.0	2.58			2.48				
4.5	3.94			3.80						
V_{OL}	LOW Level Output Voltage	2.0		0.0	0.1		0.1	V	$V_{IN} = V_{IH}$ or V_{IL}	$I_{OL} = 50 \mu\text{A}$
		3.0		0.0	0.1		0.1			
		4.5		0.0	0.1		0.1	V		$I_{OL} = 4 \text{ mA}$ $I_{OL} = 8 \text{ mA}$
		3.0			0.36		0.44			
4.5			0.36		0.44					
I_{OZ}	3-STATE Output Off-State Current	5.5			± 0.25	± 2.5		μA	$V_{IN} = V_{IH}$ or V_{IL} $V_{OUT} = V_{CC}$ or GND	
I_{IN}	Input Leakage Current	0 – 5.5			± 0.1	± 1.0		μA	$V_{IN} = 5.5V$ or GND	
I_{CC}	Quiescent Supply Current	5.5			4.0	40.0		μA	$V_{IN} = V_{CC}$ or GND	

Noise Characteristics

Symbol	Parameter	V_{CC} (V)	$T_A = 25^\circ\text{C}$		Units	Conditions
			Typ	Limits		
V_{OLP} (Note 3)	Quiet Output Maximum Dynamic V_{OL}	5.0	0.9	1.2	V	$C_L = 50 \text{ pF}$
V_{OLV} (Note 3)	Quiet Output Minimum Dynamic V_{OL}	5.0	-0.8	-1.0	V	$C_L = 50 \text{ pF}$
V_{IHD} (Note 3)	Minimum HIGH Level Dynamic Input Voltage	5.0		3.5	V	$C_L = 50 \text{ pF}$
V_{ILD} (Note 3)	Maximum HIGH Level Dynamic Input Voltage	5.0		1.5	V	$C_L = 50 \text{ pF}$

Note 3: Parameter guaranteed by design.

AC Electrical Characteristics									
Symbol	Parameter	V _{CC} (V)	T _A = 25°C			T _A = -40°C to +85°C		Units	Conditions
			Min	Typ	Max	Min	Max		
t _{PLH}	Propagation Delay Time	3.3 ± 0.3	5.0	7.0	1.0	8.5	ns	C _L = 15 pF	
t _{PHL}			7.5	10.5	1.0	12.0		C _L = 50 pF	
		5.0 ± 0.5	3.5	5.0	1.0	6.0	ns	C _L = 15 pF	
			5.0	7.0	1.0	8.0		C _L = 50 pF	
t _{PZL}	3-STATE Output Enable Time	3.3 ± 0.3	6.8	10.5	1.0	12.5	ns	R _L = 1 kΩ C _L = 15 pF	
t _{PZH}			9.3	14.0	1.0	16.0		C _L = 50 pF	
		5.0 ± 0.5	4.7	7.2	1.0	8.5	ns	C _L = 15 pF	
			6.2	9.2	1.0	10.5		C _L = 50 pF	
t _{PLZ}	3-STATE Output Disable Time	3.3 ± 0.3	11.2	15.4	1.0	17.5	ns	R _L = 1 kΩ C _L = 50 pF	
t _{PHZ}		5.0 ± 0.5	6.0	8.8	1.0	10.0			
t _{OSSLH}	Output to Output Skew	3.3 ± 0.3		1.5		1.5	ns	(Note 4) C _L = 50 pF	
t _{OSSLH}		5.0 ± 0.5		1.0		1.0			
C _{IN}	Input Capacitance		4	10		10	pF	V _{CC} = Open	
C _{OUT}	Output Capacitance		6				pF	V _{CC} = 5.0V	
C _{PD}	Power Dissipation Capacitance		18				pF	(Note 5)	

Note 4: Parameter guaranteed by design. $t_{OSSLH} = |t_{PLHmax} - t_{PLHmin}|$; $t_{OSSLH} = |t_{PHLmax} - t_{PHLmin}|$.

Note 5: C_{PD} is defined as the value of the internal equivalent capacitance which is calculated from the operating current consumption without load. Average operating current can be obtained by the equation: $I_{CC(OPR.)} = C_{PD} * V_{CC} * f_{IN} + I_{CC}/8$ (per bit).

Physical Dimensions inches (millimeters) unless otherwise noted

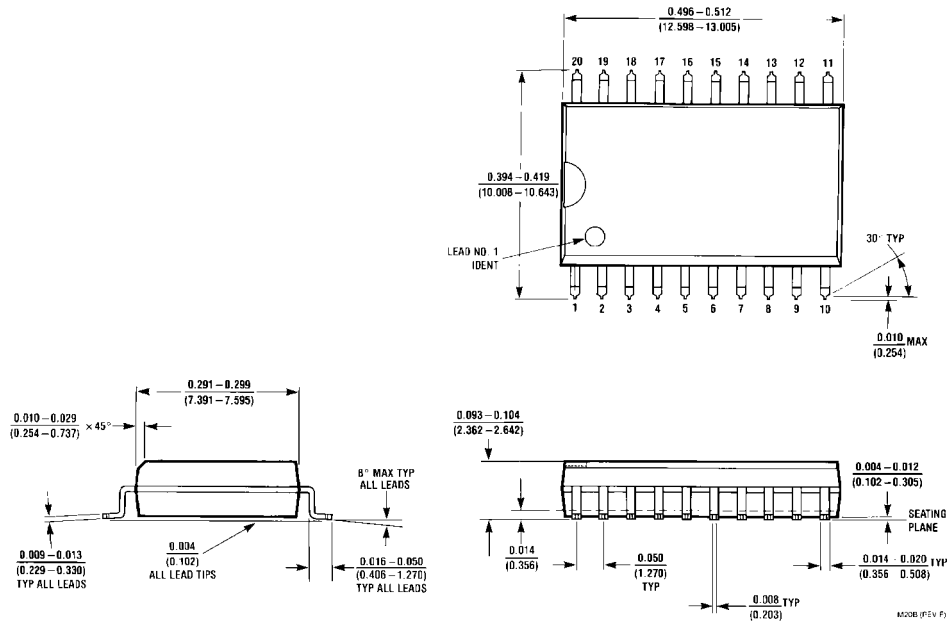

**20-Lead Small Outline Integrated Circuit (SOIC), JEDEC MS-013, 0.300" Wide
Package Number M20B**

Physical Dimensions inches (millimeters) unless otherwise noted (Continued)

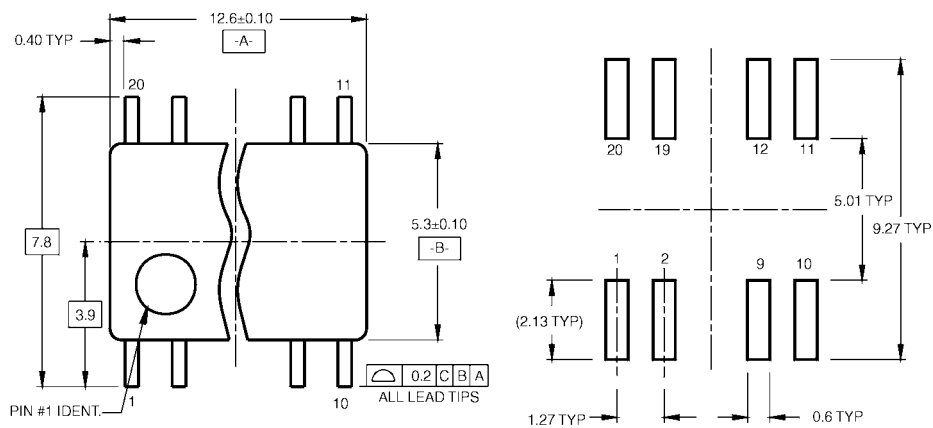

LAND PATTERN RECOMMENDATION

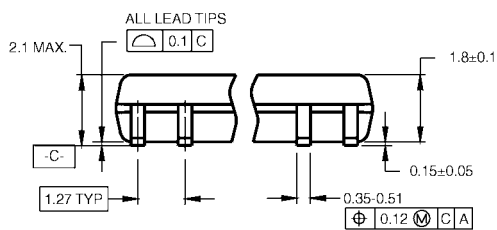

DIMENSIONS ARE IN MILLIMETERS

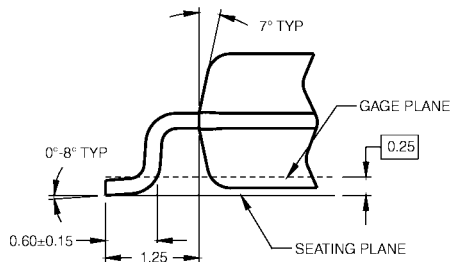
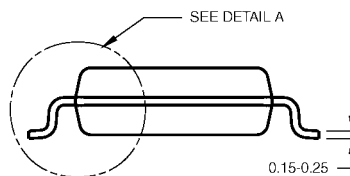

DETAIL A

- NOTES:
- A. CONFORMS TO EIAJ EDR-7320 REGISTRATION, ESTABLISHED IN DECEMBER, 1998.
 - B. DIMENSIONS ARE IN MILLIMETERS.
 - C. DIMENSIONS ARE EXCLUSIVE OF BURRS, MOLD FLASH, AND TIE BAR EXTRUSIONS.

M20DRevB1

**Pb-Free 20-Lead Small Outline Package (SOP), EIAJ TYPE II, 5.3mm Wide
Package Number M20D**

Physical Dimensions inches (millimeters) unless otherwise noted (Continued)

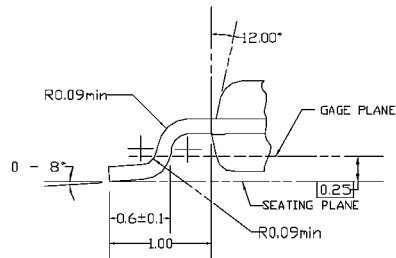
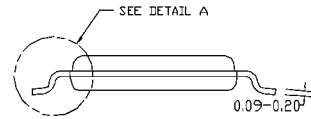
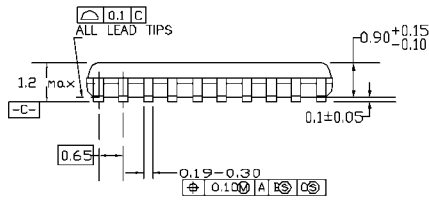
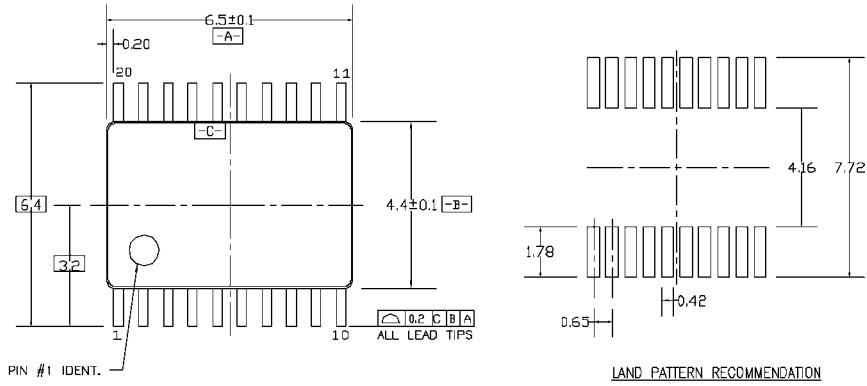

DIMENSIONS ARE IN MILLIMETERS

NOTES:

- A. CONFORMS TO JEDEC REGISTRATION MO-153, VARIATION AC, REF NOTE 6, DATE 7/93.
- B. DIMENSIONS ARE IN MILLIMETERS.
- C. DIMENSIONS ARE EXCLUSIVE OF BURRS, MOLDS FLASH, AND TIE BAR EXTRUSIONS.
- D. DIMENSIONS AND TOLERANCES PER ANSI Y14.5M, 1982.

MTC20REV D1

20-Lead Thin Shrink Small Outline Package (TSSOP), JEDEC MO-153, 4.4mm Wide Package Number MTC20

Physical Dimensions inches (millimeters) unless otherwise noted (Continued)

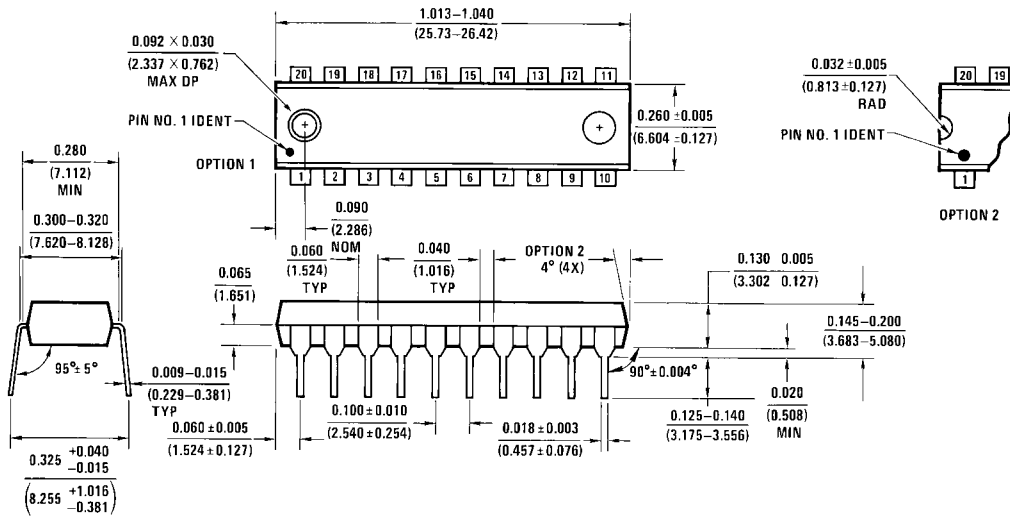

**20-Lead Plastic Dual-In-Line Package (PDIP), JEDEC MS-001, 0.300" Wide
Package Number N20A**

Fairchild does not assume any responsibility for use of any circuitry described, no circuit patent licenses are implied and Fairchild reserves the right at any time without notice to change said circuitry and specifications.

LIFE SUPPORT POLICY

FAIRCHILD'S PRODUCTS ARE NOT AUTHORIZED FOR USE AS CRITICAL COMPONENTS IN LIFE SUPPORT DEVICES OR SYSTEMS WITHOUT THE EXPRESS WRITTEN APPROVAL OF THE PRESIDENT OF FAIRCHILD SEMICONDUCTOR CORPORATION. As used herein:

1. Life support devices or systems are devices or systems which, (a) are intended for surgical implant into the body, or (b) support or sustain life, and (c) whose failure to perform when properly used in accordance with instructions for use provided in the labeling, can be reasonably expected to result in a significant injury to the user.
2. A critical component in any component of a life support device or system whose failure to perform can be reasonably expected to cause the failure of the life support device or system, or to affect its safety or effectiveness.

www.fairchildsemi.com

ON Semiconductor and  are trademarks of Semiconductor Components Industries, LLC dba ON Semiconductor or its subsidiaries in the United States and/or other countries. ON Semiconductor owns the rights to a number of patents, trademarks, copyrights, trade secrets, and other intellectual property. A listing of ON Semiconductor's product/patent coverage may be accessed at www.onsemi.com/site/pdf/Patent-Marking.pdf. ON Semiconductor reserves the right to make changes without further notice to any products herein. ON Semiconductor makes no warranty, representation or guarantee regarding the suitability of its products for any particular purpose, nor does ON Semiconductor assume any liability arising out of the application or use of any product or circuit, and specifically disclaims any and all liability, including without limitation special, consequential or incidental damages. Buyer is responsible for its products and applications using ON Semiconductor products, including compliance with all laws, regulations and safety requirements or standards, regardless of any support or applications information provided by ON Semiconductor. "Typical" parameters which may be provided in ON Semiconductor data sheets and/or specifications can and do vary in different applications and actual performance may vary over time. All operating parameters, including "Typicals" must be validated for each customer application by customer's technical experts. ON Semiconductor does not convey any license under its patent rights nor the rights of others. ON Semiconductor products are not designed, intended, or authorized for use as a critical component in life support systems or any FDA Class 3 medical devices or medical devices with a same or similar classification in a foreign jurisdiction or any devices intended for implantation in the human body. Should Buyer purchase or use ON Semiconductor products for any such unintended or unauthorized application, Buyer shall indemnify and hold ON Semiconductor and its officers, employees, subsidiaries, affiliates, and distributors harmless against all claims, costs, damages, and expenses, and reasonable attorney fees arising out of, directly or indirectly, any claim of personal injury or death associated with such unintended or unauthorized use, even if such claim alleges that ON Semiconductor was negligent regarding the design or manufacture of the part. ON Semiconductor is an Equal Opportunity/Affirmative Action Employer. This literature is subject to all applicable copyright laws and is not for resale in any manner.

PUBLICATION ORDERING INFORMATION

LITERATURE FULFILLMENT:

Literature Distribution Center for ON Semiconductor
19521 E. 32nd Pkwy, Aurora, Colorado 80011 USA
Phone: 303-675-2175 or 800-344-3860 Toll Free USA/Canada
Fax: 303-675-2176 or 800-344-3867 Toll Free USA/Canada
Email: orderlit@onsemi.com

N. American Technical Support: 800-282-9855 Toll Free
USA/Canada
Europe, Middle East and Africa Technical Support:
Phone: 421 33 790 2910
Japan Customer Focus Center
Phone: 81-3-5817-1050

ON Semiconductor Website: www.onsemi.com
Order Literature: <http://www.onsemi.com/orderlit>
For additional information, please contact your local
Sales Representative

Mouser Electronics

Authorized Distributor

Click to View Pricing, Inventory, Delivery & Lifecycle Information:

[ON Semiconductor:](#)

[74VHC541SJ](#) [74VHC541SJX](#) [74VHC541MTCX](#) [74VHC541M](#) [74VHC541MX](#) [74VHC541MTC](#) [74VHC541N](#)



Компания «ЭлектроПласт» предлагает заключение долгосрочных отношений при поставках импортных электронных компонентов на взаимовыгодных условиях!

Наши преимущества:

- Оперативные поставки широкого спектра электронных компонентов отечественного и импортного производства напрямую от производителей и с крупнейших мировых складов;
- Поставка более 17-ти миллионов наименований электронных компонентов;
- Поставка сложных, дефицитных, либо снятых с производства позиций;
- Оперативные сроки поставки под заказ (от 5 рабочих дней);
- Экспресс доставка в любую точку России;
- Техническая поддержка проекта, помощь в подборе аналогов, поставка прототипов;
- Система менеджмента качества сертифицирована по Международному стандарту ISO 9001;
- Лицензия ФСБ на осуществление работ с использованием сведений, составляющих государственную тайну;
- Поставка специализированных компонентов (Xilinx, Altera, Analog Devices, Intersil, Interpoint, Microsemi, Aeroflex, Peregrine, Syfer, Eurofarad, Texas Instrument, Miteq, Cobham, E2V, MA-COM, Hittite, Mini-Circuits, General Dynamics и др.);

Помимо этого, одним из направлений компании «ЭлектроПласт» является направление «Источники питания». Мы предлагаем Вам помощь Конструкторского отдела:

- Подбор оптимального решения, техническое обоснование при выборе компонента;
- Подбор аналогов;
- Консультации по применению компонента;
- Поставка образцов и прототипов;
- Техническая поддержка проекта;
- Защита от снятия компонента с производства.



Как с нами связаться

Телефон: 8 (812) 309 58 32 (многоканальный)

Факс: 8 (812) 320-02-42

Электронная почта: org@eplast1.ru

Адрес: 198099, г. Санкт-Петербург, ул. Калинина, дом 2, корпус 4, литера А.