

# Features

# Regulated Converter

- 4:1 wide input range
- 3kVAC reinforced insulation for 110Vin  
2.25kVDC basic insulation for 24Vin & 48Vin
- Efficiency up to 91%
- No minimum load required
- UL60950-1, EN50155 & IEC/EN60950-1 certified

# RECOM DC/DC Converter

## RP75H-RW

75 Watt  
Half Brick  
Single Output



EN50155 certified  
IEC/EN60950-1 certified  
UL60950-1 certified

## Description

The half-brick RP75H series DC/DC converters are designed for railway rolling stock and high voltage battery applications. Each series has three 4:1 input voltage range options to cover all input voltages from 9VDC up to 160VDC with isolated and regulated 5V to 48VDC outputs. The converters have high efficiencies and metal baseplates to permit a wide operating temperature range from -40°C to +85°C (when mounted on a suitable heatsink). The case is fitted with threaded inserts to allow secure mounting to the PCB or bulkhead for use in high shock and vibration environments. The converters are EN50155, UL60950 and IEC/EN60950 certified. The RP75H-RW series have a three year warranty.

## Selection Guide

Part Number	Input Voltage Range [VDC]	Output Voltage [VDC]	Output Current [mA]	Input <sup>(1)</sup> Current [mA]	Output Power [W]	Efficiency <sup>(1)</sup> typ. [%]	Max. Capacitive Load [µF]
RP75H-2405SRW	9-36	5	15000	3551	75	88	30000
RP75H-2412SRW	9-36	12	6300	3579	75	88	5250
RP75H-2415SRW	9-36	15	5000	3551	75	88	3330
RP75H-2424SRW	9-36	24	3200	3678	76	87	1330
RP75H-2448SRW	9-36	48	1600	3678	77	87	330
RP75H-4805SRW	18-75	5	15000	1736	75	90	30000
RP75H-4812SRW	18-75	12	6300	1750	75	90	5250
RP75H-4815SRW	18-75	15	5000	1755	75	89	3330
RP75H-4824SRW	18-75	24	3200	1818	76	88	1330
RP75H-4848SRW	18-75	48	1600	1839	77	87	330
RP75H-11005SRW	43-160	5	15000	749	75	91	30000
RP75H-11012SRW	43-160	12	6300	755	75	91	5250
RP75H-11015SRW	43-160	15	5000	749	75	91	3330
RP75H-11024SRW	43-160	24	3200	775	76	90	1330
RP75H-11048SRW	43-160	48	1600	775	77	90	330

### Notes:

Note1: Efficiency is tested by nominal Vin, full load and at 25°C

## Model Numbering

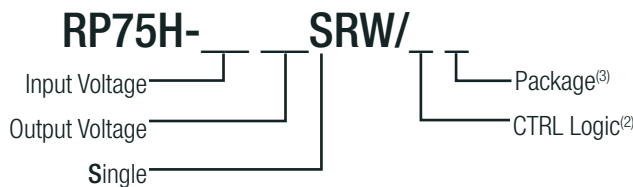

### Ordering Examples

- RP75H-2405SRW/N = 24V Input, 5V Output, Single, Neg. CTRL function
- RP75H-11012SRW/P = 110V Input, 12V Output, Single, Pos. CTRL function
- RP75H-11012SRW/P-HC = 110V Input, 12V Output, Single, Pos. CTRL function, with premounted Heat-sink

### Notes:

- Note2: standard part is with suffix "P" for positive logic (1=ON, 0=OFF) or add suffix "N" instead for negative logic (0=ON, 1=OFF)
- Note3: add suffix "-HC" for premounted Heat-sink (compatible with all other suffixes)



[www.recom-power.com/eval-ref-boards](http://www.recom-power.com/eval-ref-boards)



[https://www.recom-power.com/pdf/Powerline\\_DC-DC/RSPxxx-168.pdf](https://www.recom-power.com/pdf/Powerline_DC-DC/RSPxxx-168.pdf)

**Specifications** (measured @Ta = 25°C, resistive load, nominal Vin and rated Iout unless otherwise noted)

### BASIC CHARACTERISTICS

Parameter	Condition	Min.	Typ.	Max.
Internal Input Filter				Pi-Type
Input Voltage Range	nom Vin = 24V nom Vin = 48V nom Vin = 110V	9VDC 18VDC 43VDC	24VDC 48VDC 110VDC	36VDC 75VDC 160VDC
Input Surge Voltage	Vin = 24V, 1s max. Vin = 48V, 1s max. Vin = 110V, 1s max.			50VDC 100VDC 185VDC
Quiescent Current	Vin = 24V Vin = 48V Vin = 110V	85mA 50mA	10mA	185mA 90mA
Start-up time	Power up	Vin = 110V Vin = 24V, Vin = 48V	60ms 25ms	
	Remote ON/OFF	Vin = 110V Vin = 24V, Vin = 48V	60ms 25ms	
Internal Operating Frequency		270kHz	300kHz	330kHz
Minimum Load		0%		
Ripple and Noise	measured by 20MHz BW with a 4.7µF/50V X7R MLCC with a 4.7µF/50V X7R MLCC with a 4.7µF/50V X7R MLCC with a 2.2µF/100V X7R MLCC	5 Vout 12, 15Vout 24Vout 48Vout	75mVp-p 100mVp-p 200mVp-p 300mVp-p	100mVp-p 125mVp-p 250mVp-p 350mVp-p
Under Voltage Lockout (UVLO)	Vin = 24V	DC-DC ON DC-DC OFF	7.5VDC	9VDC
	Vin = 48V	DC-DC ON DC-DC OFF	16VDC	18VDC
	Vin = 110V	DC-DC ON DC-DC OFF	36VDC	43VDC
ON/OFF Control	Positive Logic	DC-DC ON DC-DC OFF	Open or 3.0V < Vr < 12V Short or 0V < Vr < 1.2V	
	Negative Logic	DC-DC ON DC-DC OFF	Short or 0V < Vr < 1.2V Open or 3.0V < Vr < 12V	
Input Current of CTRL pin		-0.5mA		1mA
Standby Current			3mA	
Output Trim		-20%		+10%
Remote Sense	% of set Vout			10%

### RP75H-2405SRW

Efficiency vs. Output Current

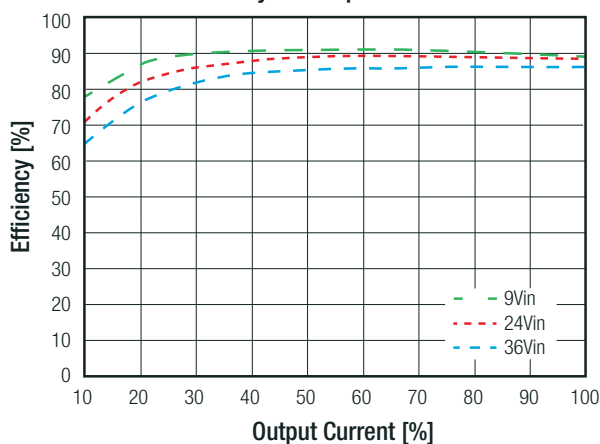

Efficiency vs. Input Voltage

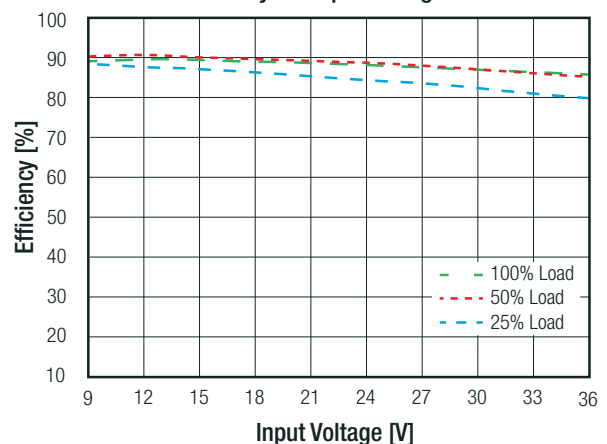

continued on next page

Specifications (measured @Ta = 25°C, resistive load, nominal Vin and rated Iout unless otherwise noted)

### RP75H-2405SRW

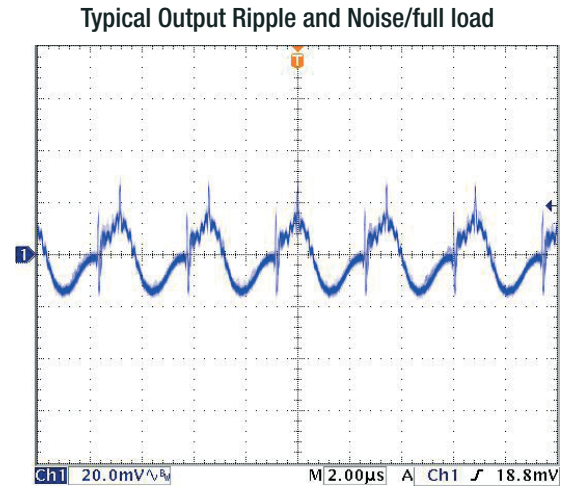
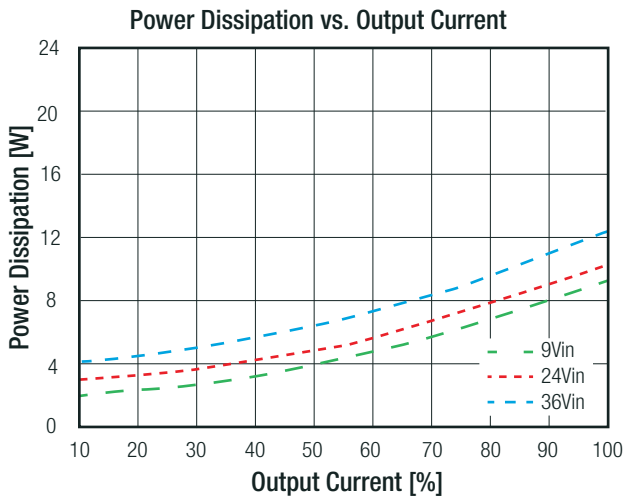

**ON/OFF Control Start-up Rise Characteristic**

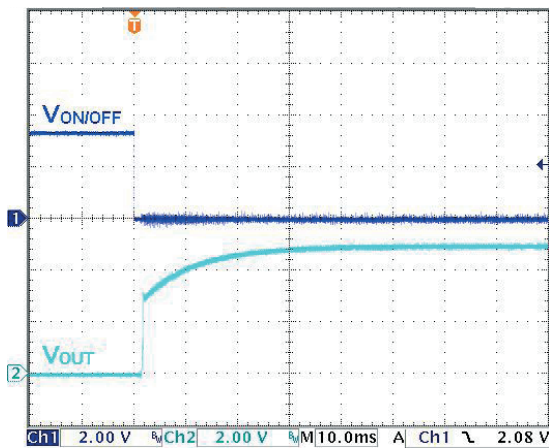

**Power up Start-up Characteristic**

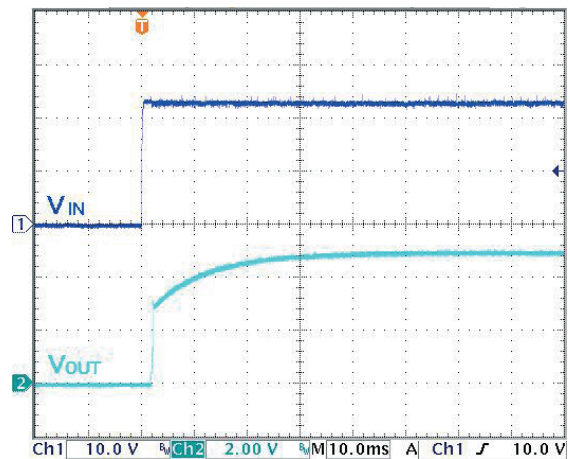

### RP75H-4805SRW

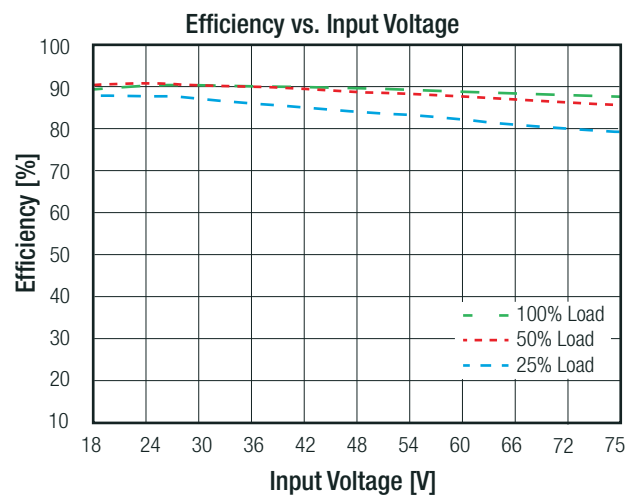
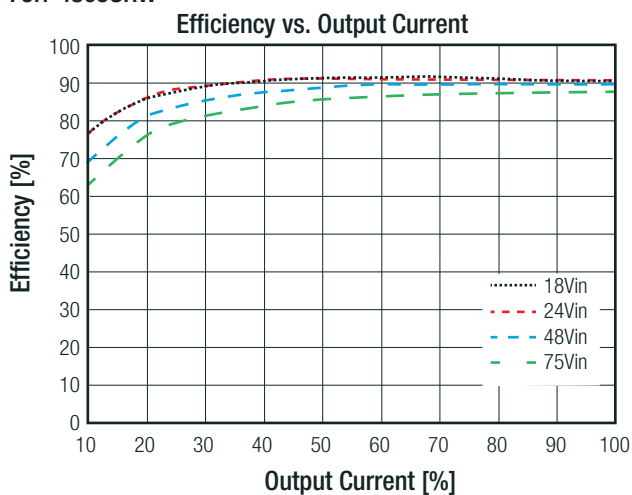

continued on next page

Specifications (measured @Ta = 25°C, resistive load, nominal Vin and rated Iout unless otherwise noted)

### RP75H-4805SRW

Power Dissipation vs. Output Current

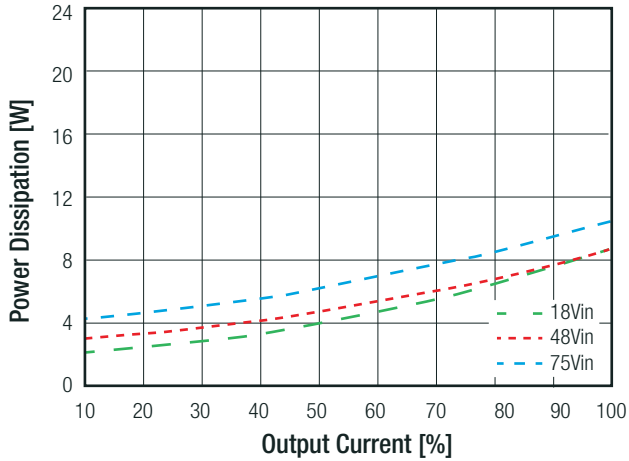

Typical Output Ripple and Noise/full load

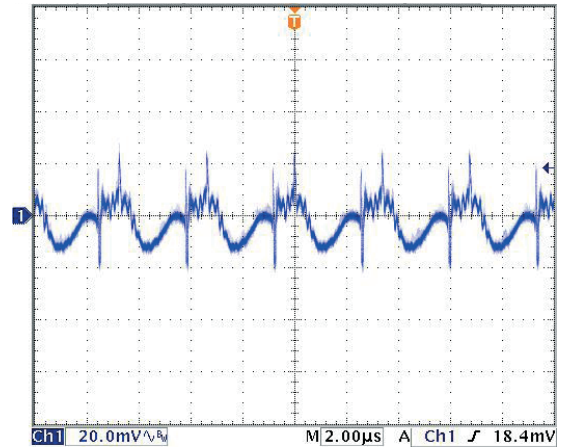

ON/OFF Control Start-up Rise Characteristic

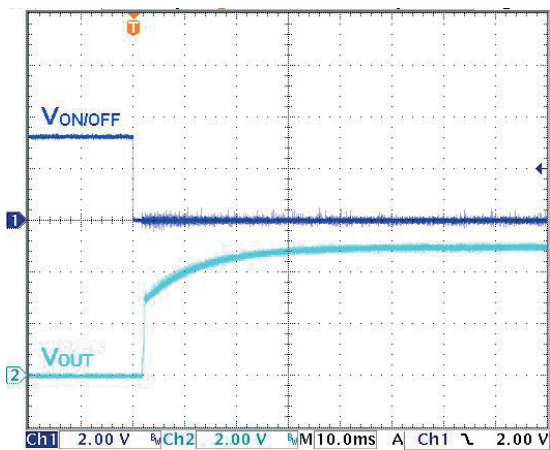

Power up Start-up Characteristic

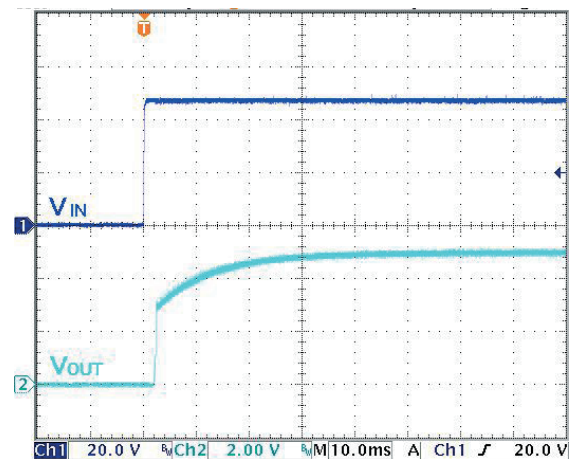

### RP75H-11005SRW

Efficiency vs. Output Current

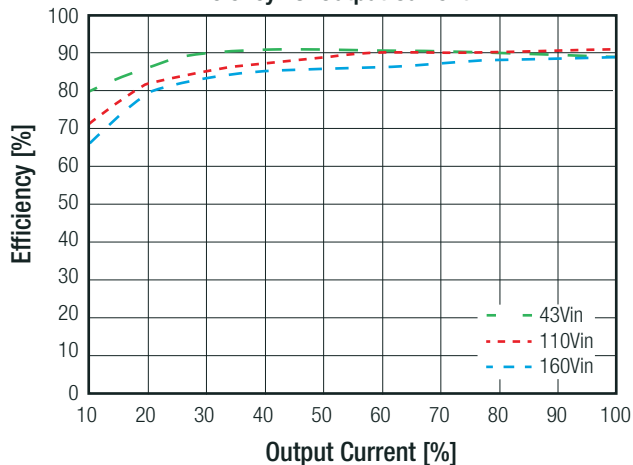

Efficiency vs. Input Voltage

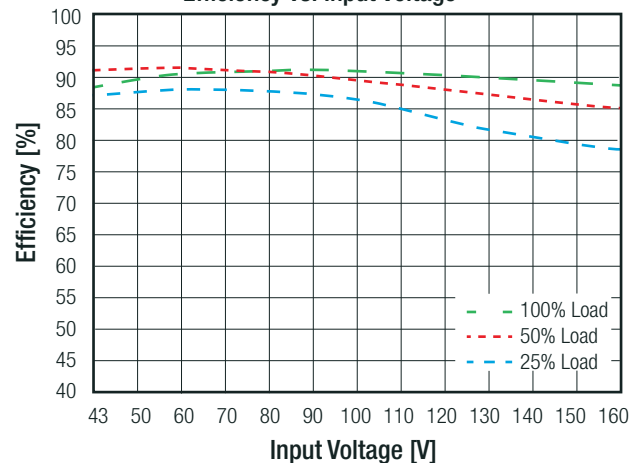

continued on next page

Specifications (measured @Ta = 25°C, resistive load, nominal Vin and rated Iout unless otherwise noted)

RP75H-11005SRW

Power Dissipation vs. Output Current

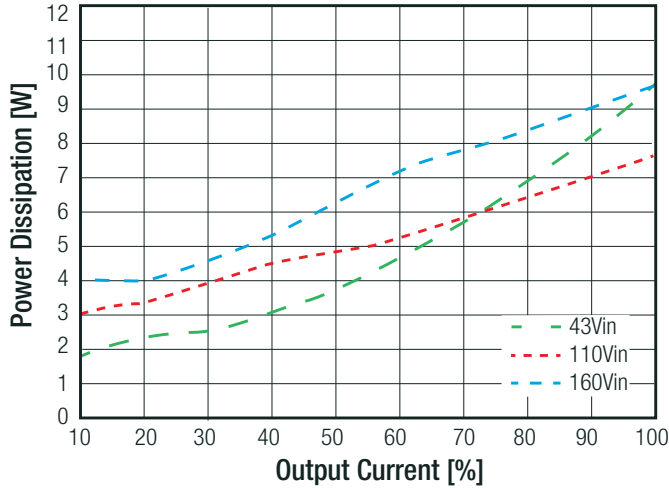

Typical Output Ripple and Noise/full load

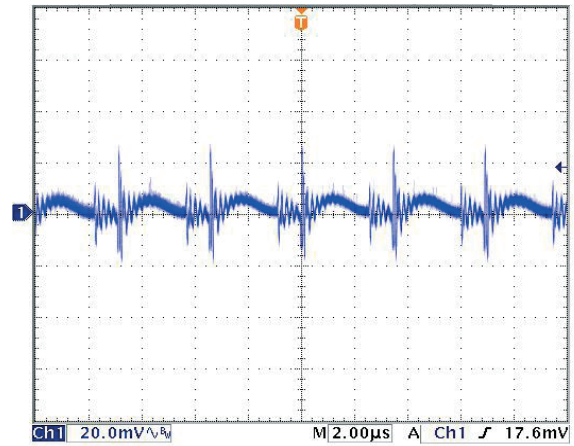

ON/OFF Control Start-up Rise Characteristic

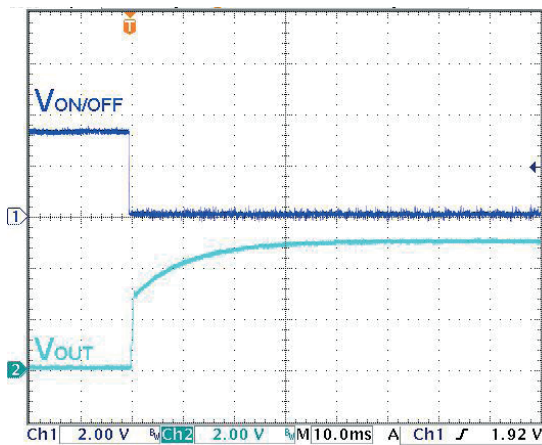

Power up Start-up Characteristic

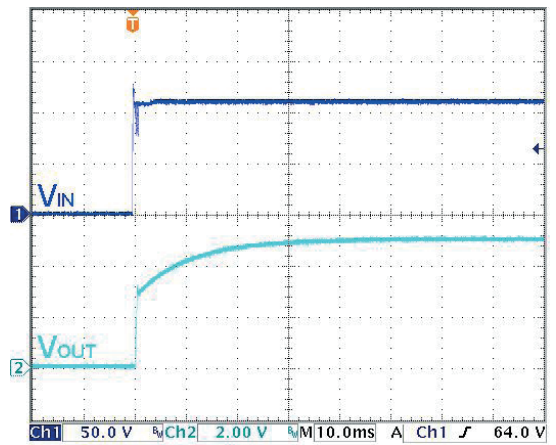

**OUTPUT TRIM**

**Output Voltage Trimming**

RP75H-RW converters offer the feature of trimming the output voltage over a certain range around the nominal value by using external trim resistors. The values for trim resistors shown in trim tables below are according to standard E96 values; therefore, the specified voltage may slightly vary; they also can be calculated with below shown equation.

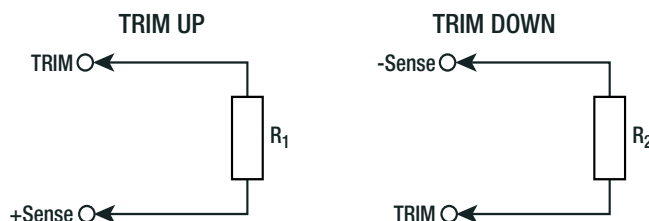



**Specifications** (measured @Ta = 25°C, resistive load, nominal Vin and rated Iout unless otherwise noted)

### OUTPUT TRIM

#### Trim Calculation

$$R_1 = \left[ \frac{100 \cdot V_{out} + \Delta V_{out} \cdot V_{out}}{1.225 \cdot \Delta V_{out}} - \frac{(100 + 2 \Delta V_{out})}{\Delta V_{out}} \right] \text{ k}\Omega$$

$$R_2 = \left[ \frac{100}{\Delta V_{out}} - 2 \right] \text{ k}\Omega$$

Vout = Output Voltage  
 $\Delta V_{out}$  = Output Voltage Trim in %  
 R1 = trim up resistor  
 R2 = trim down resistor

#### Practical Example:

##### Trim Up:

Vout = 5V,  $\Delta V_{out}$  = 10% (5.5V)

$$R_1 = \left[ \frac{100 \cdot V_{out} + \Delta V_{out} \cdot V_{out}}{1.225 \cdot \Delta V_{out}} - \frac{(100 + 2 \Delta V_{out})}{\Delta V_{out}} \right] \text{ k}\Omega = \left[ \frac{100 \cdot 5 + 10 \cdot 5}{1.225 \cdot 10} - \frac{100 + 2 \cdot 10}{10} \right] = 44.89 - 12 = 32.9 \text{ k}\Omega$$

##### Trim down:

Vout = 5V,  $\Delta V_{out}$  = -10% (4.5V)

$$R_2 = \left[ \frac{100}{\Delta V_{out}} - 2 \right] \text{ k}\Omega = \left[ \frac{100}{10} - 2 \right] = 8.06 \text{ k}\Omega$$

#### RP75H-xx05SRW

Trim up	1	2	3	4	5	6	7	8	9	10	%
Vout =	5.05	5.10	5.15	5.20	5.25	5.30	5.35	5.4	5.45	5.50	Volts
R <sub>1</sub> =	309	158	105	78.7	63.4	53.6	46.4	40.2	36.5	33.2	KOhms

#### RP75H-xx12SRW

Trim up	1	2	3	4	5	6	7	8	9	10	%
Vout =	12.12	12.24	12.36	12.48	12.60	12.72	12.84	12.96	13.08	13.20	Volts
R <sub>1</sub> =	887	453	301	226	182	154	133	118	105	95.3	KOhms

#### RP75H-xx15SRW

Trim up	1	2	3	4	5	6	7	8	9	10	%
Vout =	15.15	15.30	15.45	15.60	15.75	15.90	16.05	16.20	16.35	16.50	Volts
R <sub>1</sub> =	1130	576	383	294	237	196	169	150	137	124	KOhms

#### RP75H-xx24SRW

Trim up	1	2	3	4	5	6	7	8	9	10	%
Vout =	24.24	24.48	24.72	24.96	25.20	25.44	25.68	25.92	26.16	26.40	Volts
R <sub>1</sub> =	1870	953	634	487	392	324	280	249	226	205	KOhms

#### RP75H-xx48SRW

Trim up	1	2	3	4	5	6	7	8	9	10	%
Vout =	48.48	48.96	49.44	49.92	50.40	50.88	51.36	51.84	52.32	52.80	Volts
R <sub>1</sub> =	3830	1960	1300	1000	806	681	576	511	464	422	KOhms

#### Trim Down all Vout's

Trim down	1	2	3	4	5	6	7	8	9	10	%
R <sub>2</sub> =	97.6	47.5	31.6	23.2	17.8	14.7	12.1	10.5	9.09	8.06	KOhms
Trim down	11	12	13	14	15	16	17	18	19	20	%
R <sub>2</sub> =	7.15	6.34	5.76	5.11	4.64	4.22	3.92	3.57	3.24	3.01	KOhms

continued on next page

Specifications (measured @Ta = 25°C, resistive load, nominal Vin and rated Iout unless otherwise noted)

**Remote Sense**

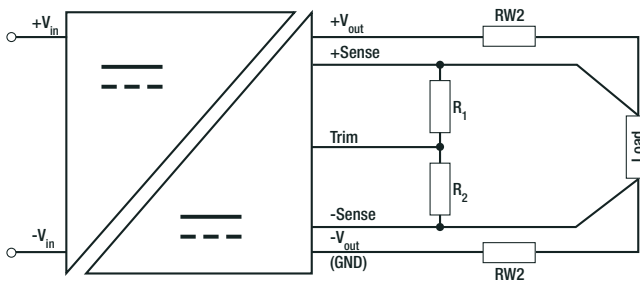

The output voltage can be adjusted by both trim and remote sense. The maximum combined adjustment range  $\pm 10\%$ . Derate the maximum output power if using the trim or sense function.

- R<sub>W1</sub> ... wire losses +
- R<sub>W2</sub> ... wire losses -
- R<sub>1</sub> ... trim up resistor
- R<sub>2</sub> ... trim down resistor

**REGULATIONS**

Parameter	Condition	Value
Output Accuracy		$\pm 1.0\%$
Line Regulation	low line to high line at full load	$\pm 0.1\%$
Load Regulation	0% to 100% load	0.1%
Transient Response	25% load step change	200 $\mu$ s typ.; 250 $\mu$ s max.

**Transient Response to Dynamic Load Change from 100% to 75% to 100% of Full Load at nom.Vin**

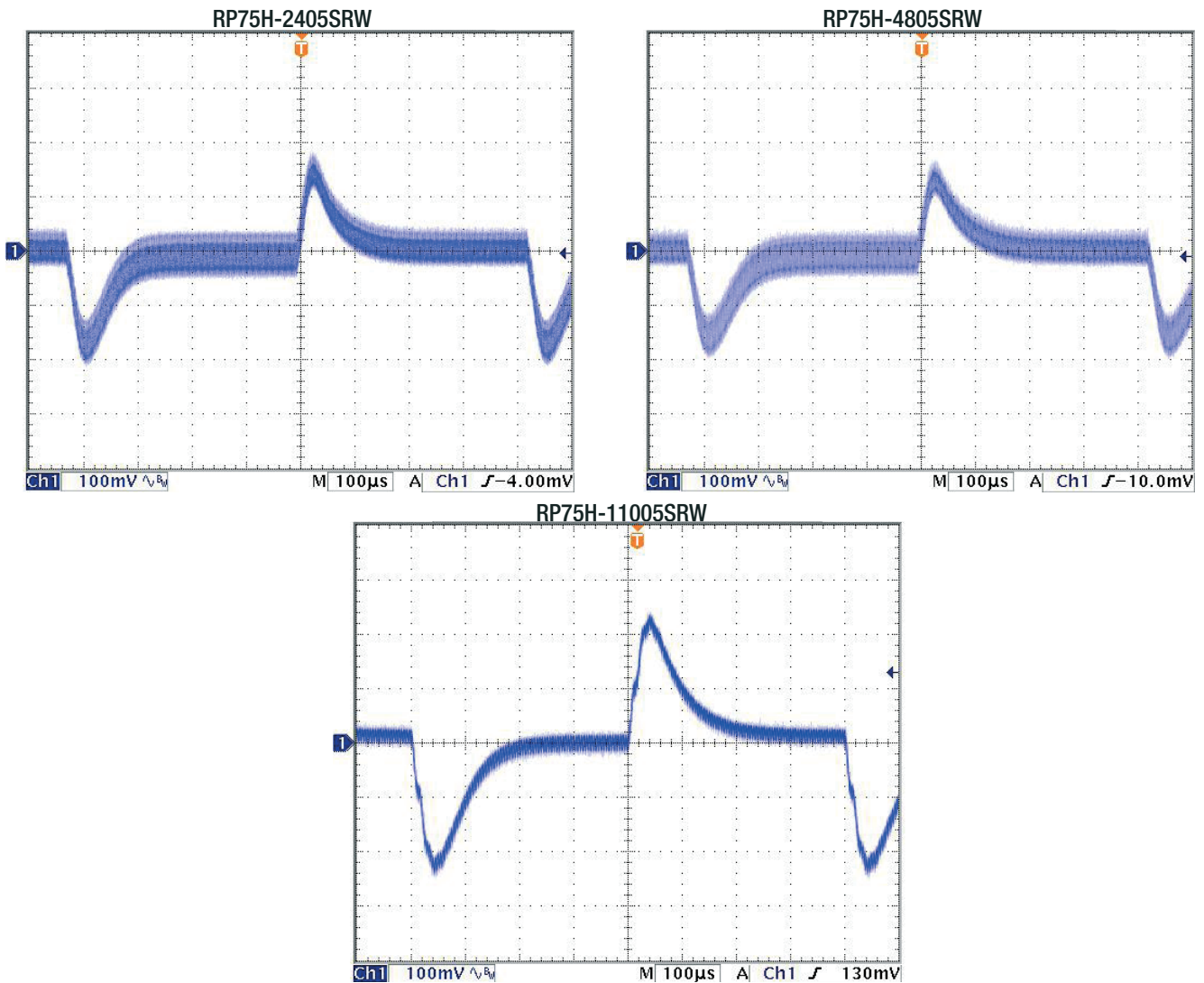

**Specifications** (measured @Ta = 25°C, resistive load, nominal Vin and rated Iout unless otherwise noted)

**PROTECTIONS**

Parameter	Condition		Value
Short Circuit Protection (SCP)	below 100mΩ		continuous, automatic recovery
Over Voltage Protection (OVP)	% of nom. Vout		115%-130%, Hiccup Mode
Over Load Protection (OLP)	% Iout rated	24Vin, 48Vin 110Vin	120%-150%, Hiccup Mode 150% typ., Hiccup Mode
Over Temperature Protection (OTP)			+115°C
Isolation Voltage	110Vin	I/P to O/P I/P or O/P to Baseplate	3kVAC/1minute 1.5kVAC/1minute
	24Vin, 48Vin	I/P to O/P I/P or O/P to Baseplate	2.25kVDC/1minute 1.6kVDC/1minute
Isolation Resistance	500 VDC		1GΩ min.
Isolation Capacitance			2500pF max.
Isolation Grade	24Vin, 48 Vin 110Vin		basic Insulation reinforced Insulation

**Notes:**

Note4: Refer to local wiring regulations if input over-current protection is also required. Recommended fuse: T30A slow blow

**ENVIRONMENTAL**

Parameter	Condition	Value
Operating Case Temperature Range	Baseplate	refer to derating graph
Maximum Case Temperature		105°C
Temperature Coefficient		±0.02%/°C max.
Thermal Impedance	vertical direction by natural convection (0.1m/s) without Heat-sink	6.7°C/W
	vertical direction by natural convection (0.1m/s) with Heat-sink	4.7°C/W
Operating Humidity		5% - 95% RH
Pollution Degree	24Vin, 48Vin	PD1
	110Vin	PD2
Shock		according to EN61373 standard
Thermal Shock		according to MIL-STD-810F standard
Vibration		according to EN61373 standard
Fire protection on railway vehicles		according to EN45545-2, 2013 standard
MTBF	according to MIL-HDBK-217F, G.B.	+25°C 336.2 x 10 <sup>3</sup> hours

**Thermal Calculation**

$$R_{th\text{case-ambient}} = 6.7^{\circ}\text{C/W (vertical)}$$

$$R_{th\text{case-ambientHC}} = 4.7^{\circ}\text{C/W (vertical)}$$

$$R_{th\text{case-ambient}} = \frac{T_{\text{case}} - T_{\text{ambient}}}{P_{\text{dissipation}}}$$

$$P_{\text{dissipation}} = P_{\text{IN}} - P_{\text{OUT}} = \frac{P_{\text{OUTapp}}}{\eta} - P_{\text{OUTapp}}$$

$T_{\text{case}}$	=	Case Temperature
$T_{\text{ambient}}$	=	Environment Temperature
$P_{\text{dissipation}}$	=	Internal losses
$P_{\text{IN}}$	=	Input Power
$P_{\text{OUT}}$	=	Output Power
$\eta$	=	Efficiency under given Operating Conditions
$R_{th\text{case-ambient}}$	=	Thermal Impedance

**Practical Example:**

Take the RP75H-2405SRW with 9V input Voltage and 50% load. What is the maximum ambient operating temperature? Use converter vertical in application without airflow.

$$\text{Eff}_{\text{min}} = 90\% @ V_{\text{nom}}$$

$$P_{\text{OUT}} = 75\text{W}$$

$$P_{\text{OUTapp}} = 75 \times 0.5 = 37.5\text{W}$$

$$\eta = 92\% \text{ (Efficiency vs. Load Graph)}$$

$$P_{\text{dissipation}} = \frac{37.5}{0.92} - 37.5 = 3.26\text{W}$$

**without Heat-sink**

$$R_{\text{th}} = \frac{T_{\text{casemax}} - T_{\text{amb}}}{P_{\text{dissipation}}} \rightarrow 6.7^{\circ}\text{C/W} = \frac{105 - T_{\text{amb}}}{3.26\text{W}}$$

$$T_{\text{amb}} = 83^{\circ}\text{C}$$

**with Heat-sink**

$$R_{\text{thHC}} = \frac{T_{\text{casemax}} - T_{\text{amb}}}{P_{\text{dissipation}}} \rightarrow 4.7^{\circ}\text{C/W} = \frac{105 - T_{\text{amb}}}{3.26\text{W}}$$

$$T_{\text{ambHC}} = 89^{\circ}\text{C}$$

continued on next page



**Specifications** (measured @Ta = 25°C, resistive load, nominal Vin and rated Iout unless otherwise noted)

### Derating Graph<sup>(5)</sup>

(@ Chamber and natural convection 0.1 m/s)

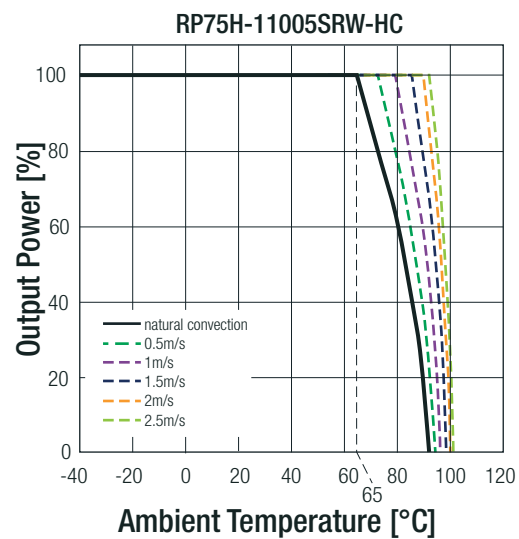
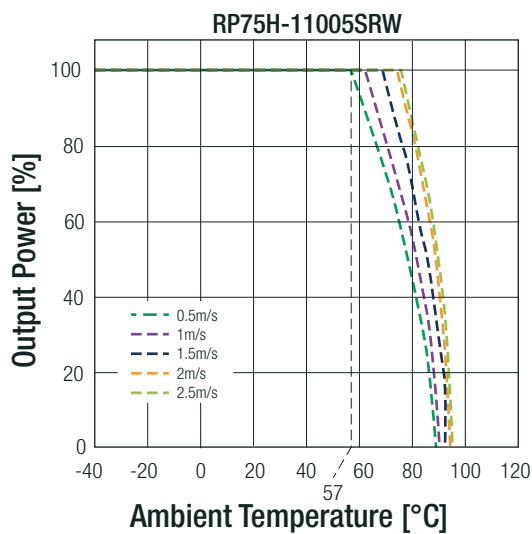
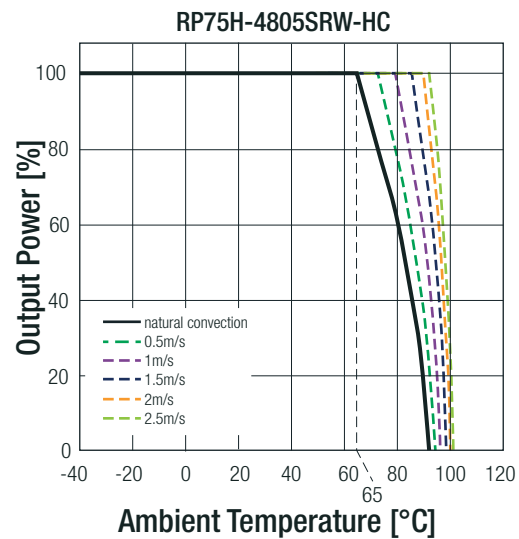
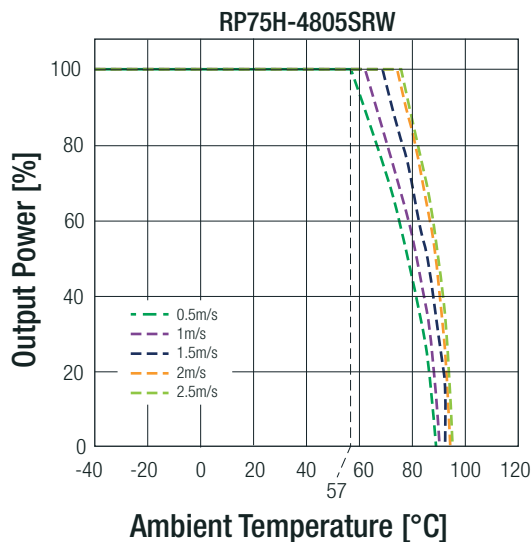
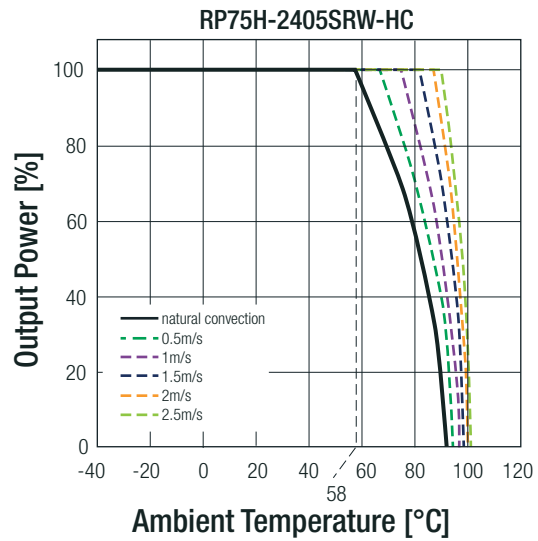
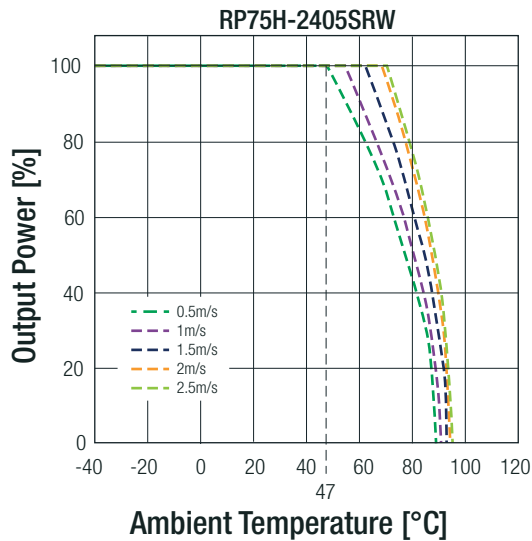

### Notes:

Note5: Derating graphs are valid only for the shown part numbers. If you need detailed derating-information about a part-number not shown here please contact our technical support service at [techsupportAT@recom-power.com](mailto:techsupportAT@recom-power.com)

**Specifications** (measured @Ta = 25°C, resistive load, nominal Vin and rated Iout unless otherwise noted)

SAFETY AND CERTIFICATIONS		
Certificate Type (Safety)	Report / File Number	Standard
Information Technology Equipment, General Requirements for Safety	E196683	UL60950-1, 2nd Edition, 2014 CSA C22.2 No. 60950-1-07, 2nd Edition, 2014
IEC/EN Information Technology Equipment - General Requirements for Safety	TW1608034-001, TW1608035-001	IEC60950-1, 2nd Edition, 2005 EN60950-1, 2nd Edition, 2006
Railway Applications - Electrical Equipment used on rolling stock	16A081501E-C	EN50155, 2007
EAC	RU-AT.49.09571	TP TC 004/2011
RoHS 2+		RoHS 2011/65/EU

EMI Compliance	Condition	Standard / Criterion
Information technology equipment - Radio disturbance characteristics - Limits and methods of measurement	110Vin with external components	EN55022, Class A and Class B
Industrial, scientific and medical equipment - Radio frequency disturbance characteristics - Limits and methods of measurement		EN55011, Class A and Class B
Low-voltage power supplies DC output - Part 3: Electromagnetic compatibility (EMC)	24Vin, 48Vin with external components	EN61204-3, Class B
ESD Electrostatic discharge immunity test	Air ±8kV and Contact ±6kV 20V/m (110Vin), 10V/m (24Vin,48Vin) ±2kV EN55024 & EN50155 ±2kV (±1kV, 24Vin, 48Vin) 10 Vr.m.s	EN61000-4-2, Criteria A
Radiated, radio-frequency, electromagnetic field immunity test		EN61000-4-3, Criteria A
Fast Transient and Burst Immunity <sup>(6)</sup>		EN61000-4-4, Criteria A
Surge Immunity <sup>(6)</sup>		EN61000-4-5, Criteria A
Immunity to conducted disturbances, induced by radio-frequency fields		EN61000-4-6, Criteria A

**Notes:**

Note6: An external input filter capacitor is required if the module has to meet EN61000-4-4 and EN61000-4-5.

The **24Vin** and **48Vin** version recommend 2pcs of aluminium electrolytic capacitor to connect in parallel.  
Recom suggest: 220µF/100V.

The **110Vin** version recommend 2pcs of aluminium electrolytic capacitor to connect in parallel.  
Recom suggest: 150µF/200V

**EMI Filtering according to EN61204-3 Class A and EN50121-1 (24Vin and 48Vin)**

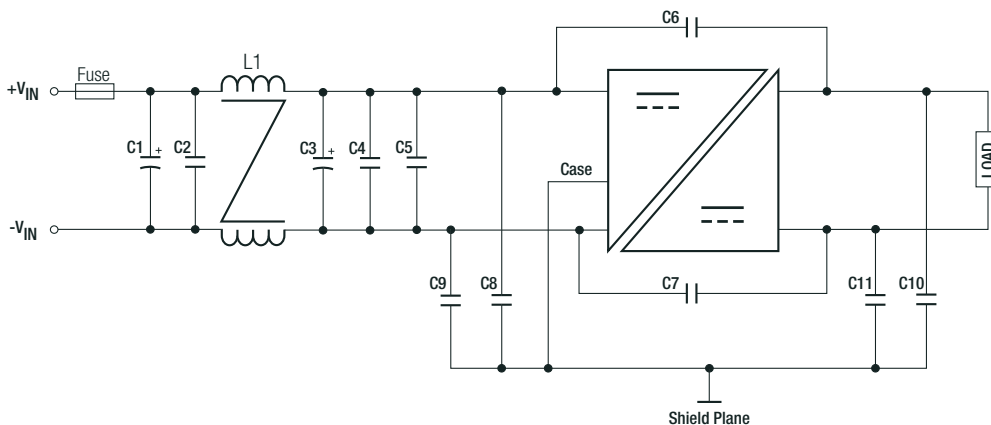

MODEL	C1, C3	C2, C4, C5	C6 to C11	L1
RP75H-24xxSRW	100µF, 50V Al Cap. Chemi-con KY Series	4.7µF, 50V 1812 MLCC	1000pF, 3kV 1808 MLCC	156µH CMC
RP75H-48xxSRW	100µF, 100V Al Cap. Chemi-con KY Series	2.2µF, 100V 1812 MLCC	1000pF, 3kV 1808 MLCC	620µH CMC

continued on next page

Specifications (measured @Ta = 25°C, resistive load, nominal Vin and rated Iout unless otherwise noted)

RP75H-2405SRW

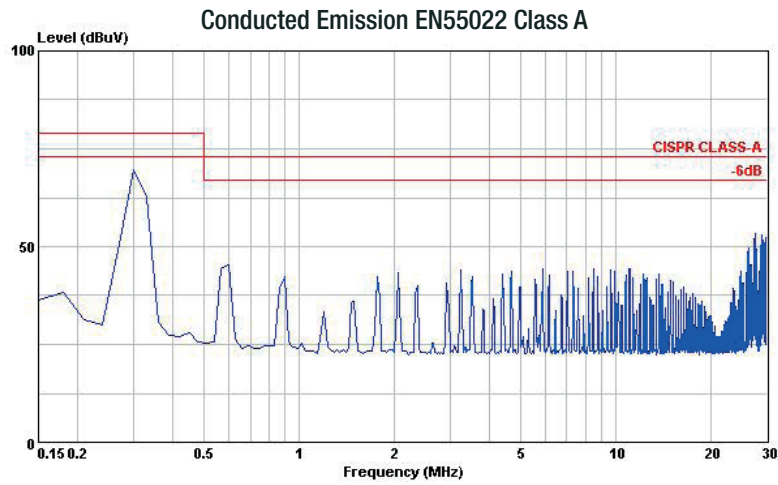

RP75H-4805SRW

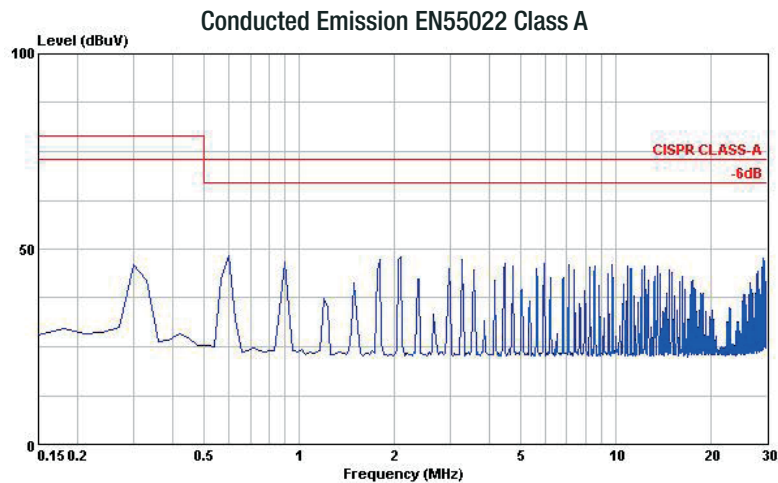

EMI Filtering according to EN55022/11 Class A and EN50121-1 (110Vin)

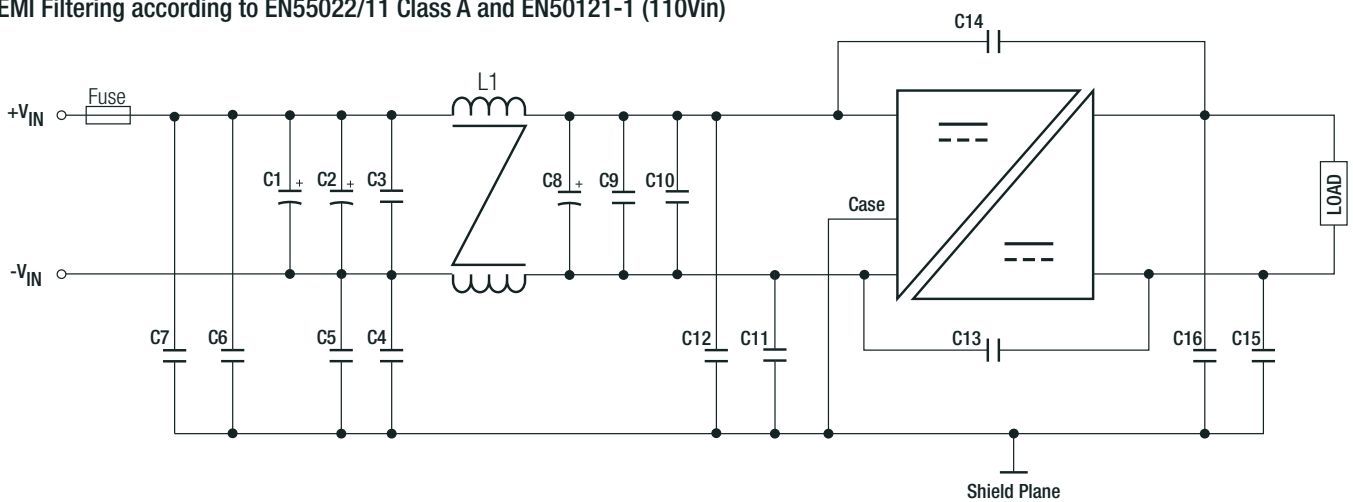

MODEL	C1, C8	C10	C13, C14	C5, C15, C16	L1
RP75H-110xxSRW	150µF, 200V Al Capacitor (lie down) Chemi-con KXJ	1µF, 250V 1812 MLCC	1000pF, 400VAC TDK CD Series	1000pF, 5kV 1808 MLCC	521µH CMC
C2, C3, C4, C6, C7, C9, C11, C12: N/A					

continued on next page

Specifications (measured @Ta = 25°C, resistive load, nominal Vin and rated Iout unless otherwise noted)

### RP75H-11005SRW

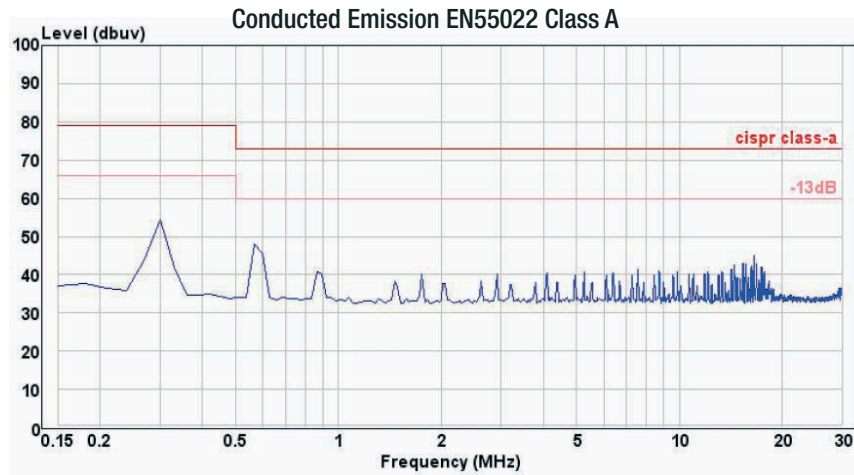

### EMI Filtering according to EN61204-3 Class B (24Vin and 48Vin)

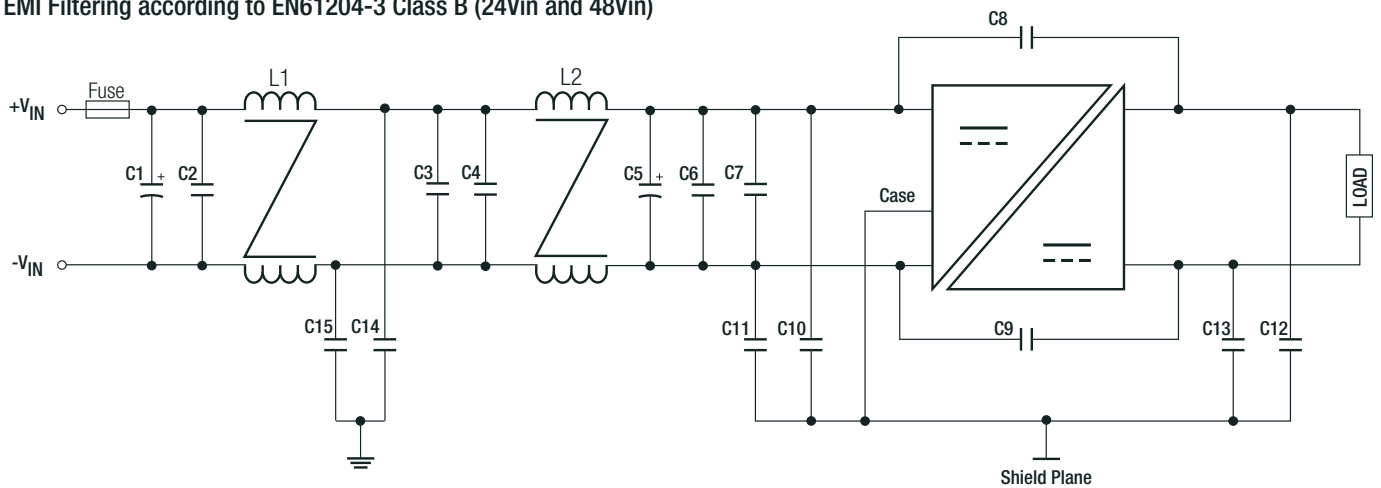

MODEL	C1, C5	C2, C3, C4, C6, C7	C8, C14, C15	C9	C10 to C13	L1	L2
RP75H-24xxSRW	100µF, 50V Al Cap. (lie down) Chemi-con KY	4.7µF, 50V 1812 MLCC	1000pF, 3kV 1808 MLCC	1000pF, 3kV 1808 MLCC	10nF, 2kV 1812 MLCC	305µH CMC	305µH CMC
RP75H-48xxSRW	100µF, 100V Al Cap. (lie down) Chemi-con KY	2.2µF, 100V 1812 MLCC	1000pF, 3kV 1808 MLCC	4700pF, 3kV 1812 MLCC	10nF, 2kV 1812 MLCC	1186µH CMC	156µH CMC

### RP75H-2405SRW

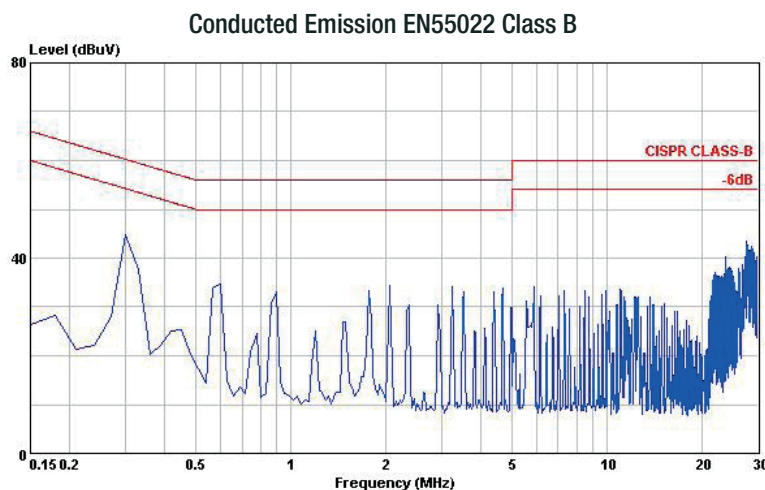

continued on next page

**Specifications** (measured @Ta = 25°C, resistive load, nominal Vin and rated Iout unless otherwise noted)

### RP75H-4805SRW

#### Conducted Emission EN55022 Class B

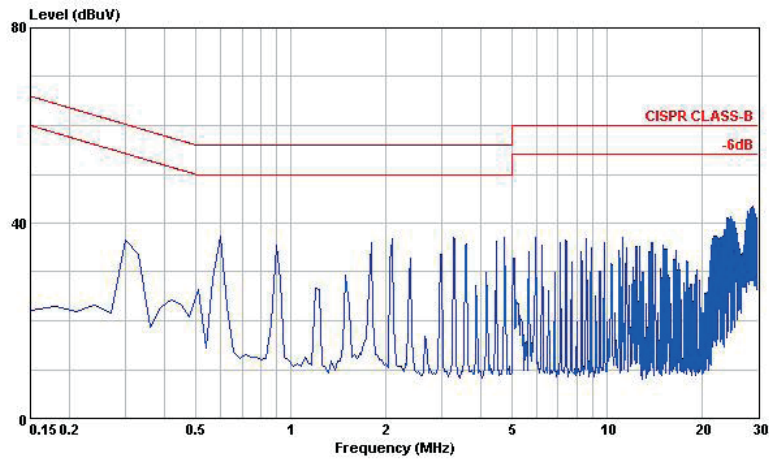

#### EMI Filtering according to EN55022/11 Class B (110Vin)

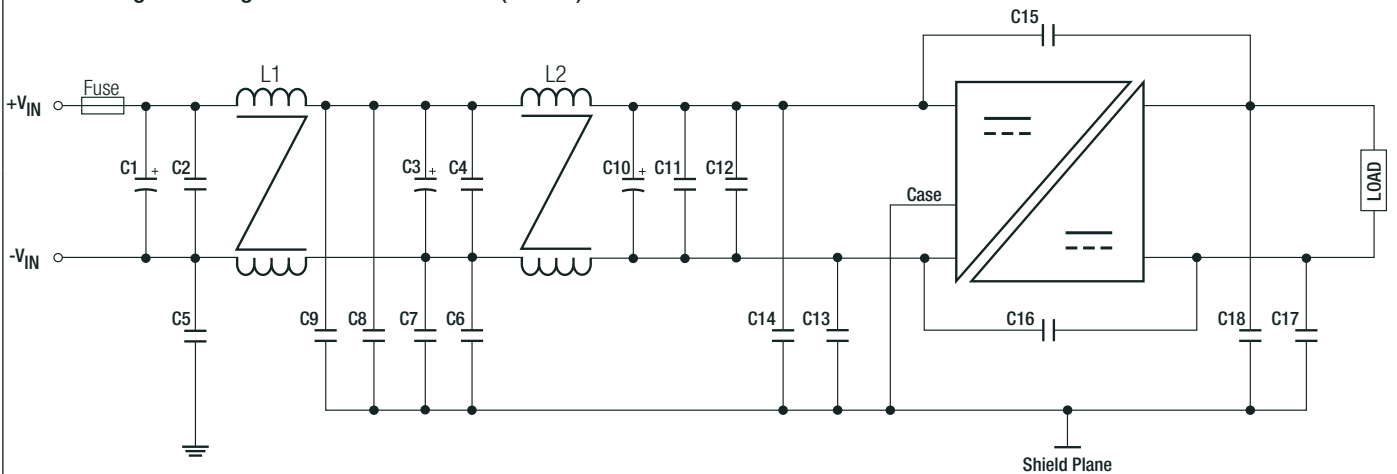

MODEL	C1, C3, C10	C11, C12	C13	C15, C16	C6, C7, C8, C9, C17, C18	L1	L2
RP75H-110xxSRW	150µF, 200V Al Cap. (lie down) Chemi-con KXJ	1µF, 250V 1812 MLCC	330pF, 5kV 1808 MLCC	1000pF, 400VAC TDK CD Series	1000pF, 5kV 1808MLCC	305µH CMC	806µH CMC
C2, C4, C5, C14: N/A							

### RP75H-11005SRW

#### Conducted Emission EN55022 Class B

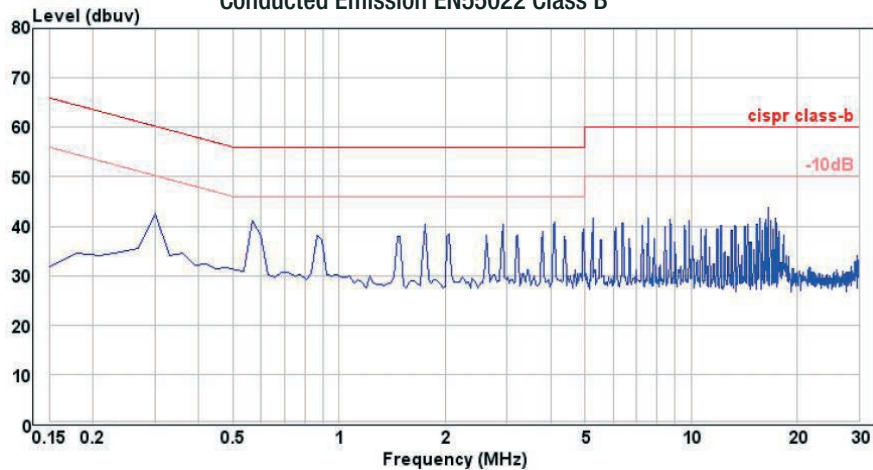



**Specifications** (measured @Ta = 25°C, resistive load, nominal Vin and rated Iout unless otherwise noted)

### DIMENSIONS and PHYSICAL CHARACTERISTICS

Parameter	Type		Value
Material	case	24Vin, 48Vin	Metal
		110Vin	Plastic
	baseplate	24Vin, 48Vin	FR4 PCB
		110Vin	Aluminium
	potting		Silicone (UL94 V-0)
Packaging Dimension (LxWxH)	without Heat-sink		61.0 x 57.9 x 12.7mm
	with Heat-sink		61.0 x 57.9 x 24.13mm
Packaging Weight	without Heat-sink		105g
	with Heat-sink		157g

### Dimension Drawing (mm)

#### 24Vin, 48Vin

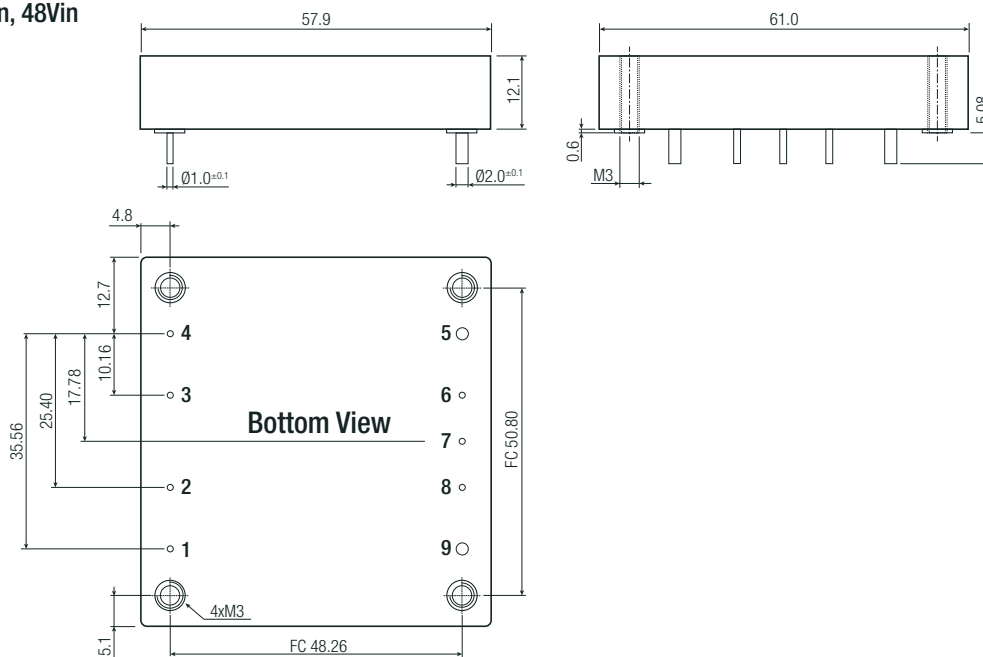

#### 110Vin

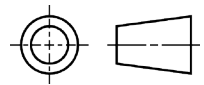
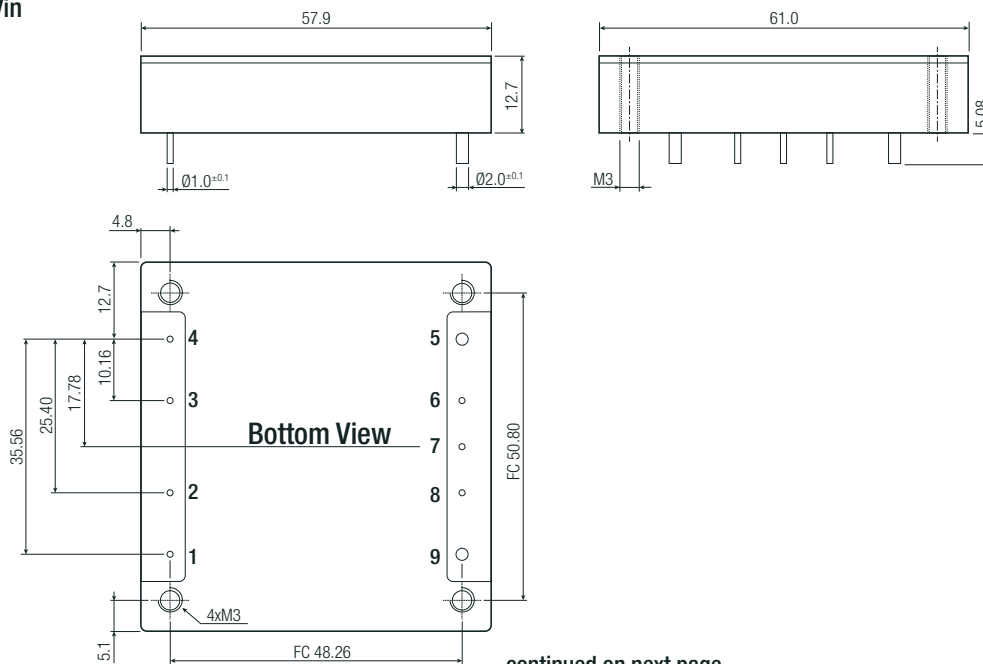

### Pin Connections

Pin #	Single
1	+Vin
2	CTRL
3	Case
4	-Vin
5	-Vout
6	-Sense
7	Trim
8	+Sense
9	+Vout

FC= Fixing Centers for Heat-sink  
 Pin Pitch Tolerance ±0.25mm  
 Pin Dimension Tolerance ±0.1mm  
 XX.X ± 0.5mm  
 XX.XX ± 0.25mm

continued on next page

**Specifications** (measured @Ta = 25°C, resistive load, nominal Vin and rated Iout unless otherwise noted)

**110Vin with Heat-sink**

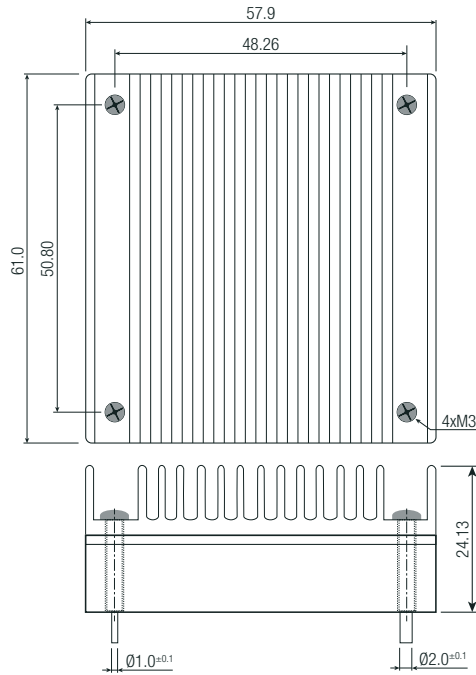

**Notes:**

Note7: Max. tightening torque for Heat-sink: 0.34Nm



**PACKAGING INFORMATION**

Parameter	Type		Value
	Tray		
Packaging Dimension		without Heat-sink	157.0 x 88.0 x 12.8mm
		with Heat-sink	157.0 x 88.0 x 24.8mm
Packaging Quantity			2pcs.
Storage Temperature Range			-55°C to +125°C
Storage Humidity			5% - 95% RH

The product information and specifications may be subject to changes even without prior written notice. The product has been designed for various applications; its suitability lies in the responsibility of each customer. The products are not authorized for use in safety-critical applications without RECOM's explicit written consent. A safety-critical application is an application where a failure may reasonably be expected to endanger or cause loss of life, inflict bodily harm or damage property. The applicant shall indemnify and hold harmless RECOM, its affiliated companies and its representatives against any damage claims in connection with the unauthorized use of RECOM products in such safety-critical applications.



Компания «ЭлектроПласт» предлагает заключение долгосрочных отношений при поставках импортных электронных компонентов на взаимовыгодных условиях!

Наши преимущества:

- Оперативные поставки широкого спектра электронных компонентов отечественного и импортного производства напрямую от производителей и с крупнейших мировых складов;
- Поставка более 17-ти миллионов наименований электронных компонентов;
- Поставка сложных, дефицитных, либо снятых с производства позиций;
- Оперативные сроки поставки под заказ (от 5 рабочих дней);
- Экспресс доставка в любую точку России;
- Техническая поддержка проекта, помощь в подборе аналогов, поставка прототипов;
- Система менеджмента качества сертифицирована по Международному стандарту ISO 9001;
- Лицензия ФСБ на осуществление работ с использованием сведений, составляющих государственную тайну;
- Поставка специализированных компонентов (Xilinx, Altera, Analog Devices, Intersil, Interpoint, Microsemi, Aeroflex, Peregrine, Syfer, Eurofarad, Texas Instrument, Miteq, Cobham, E2V, MA-COM, Hittite, Mini-Circuits, General Dynamics и др.);

Помимо этого, одним из направлений компании «ЭлектроПласт» является направление «Источники питания». Мы предлагаем Вам помощь Конструкторского отдела:

- Подбор оптимального решения, техническое обоснование при выборе компонента;
- Подбор аналогов;
- Консультации по применению компонента;
- Поставка образцов и прототипов;
- Техническая поддержка проекта;
- Защита от снятия компонента с производства.



#### Как с нами связаться

**Телефон:** 8 (812) 309 58 32 (многоканальный)

**Факс:** 8 (812) 320-02-42

**Электронная почта:** [org@eplast1.ru](mailto:org@eplast1.ru)

**Адрес:** 198099, г. Санкт-Петербург, ул. Калинина, дом 2, корпус 4, литера А.