

SILICON RFIC 2.5 GHz FREQUENCY UP-CONVERTER FOR WIRELESS TRANSCEIVER

FEATURES

- **RECOMMENDED OPERATING FREQUENCY:**
f_{RFout} = 0.8 to 2.5 GHz
- **SUPPLY VOLTAGE:**
V_{CC} = 2.7 to 3.3 V
- **HIGHER IP₃ AND CONVERSION GAIN:**
CG = 9.5 dB TYP
OIP₃ = +7.5 dBm TYP @ f_{RFout} = 0.9 GHz
- **HIGH-DENSITY SURFACE MOUNTING:**
6-pin super minimold package

DESCRIPTION

The UPC8172TB is a silicon monolithic integrated circuit designed as a frequency up-converter for a wireless transceiver transmitter stage. This IC is manufactured using the 30 GHz f_{max} UHS0 (Ultra High Speed Process) silicon bipolar process. This IC has the same circuit current as the conventional UPC8106TB, but operates at higher frequency, higher gain and lower distortion. Such performance and operation from a 3 volts supply makes this device ideal for mobile communications and wireless LAN applications.

Stringent quality assurance and test procedures ensure the highest reliability and performance.

ELECTRICAL CHARACTERISTICS

(T_A = 25°C, V_{CC} = V_{RFOUT} = 3.0 V, f_{IFin} = 240 MHz, P_{LOin} = -5 dBm, and V_{PS} ≥ 2.7 V unless otherwise specified))

PART NUMBER PACKAGE OUTLINE			UPC8172TB S06		
SYMBOLS	PARAMETERS AND CONDITIONS ¹	UNITS	MIN	TYP	MAX
I _{CC}	Circuit Current (no signal)	mA	5.5	9.0	13.0
I _{CC(PS)}	Circuit Current in Power Save Mode, V _{PS} = 0 V	μA	–	–	2
CG1	Conversion Gain,	f _{RFout} = 0.9 GHz, P _{IFin} = -30 dBm	dB	6.5	12.5
CG2		f _{RFout} = 1.9 GHz, P _{IFin} = -30 dBm	dB	5.5	11.5
CG3		f _{RFout} = 2.4 GHz, P _{IFin} = -30 dBm	dB	5.0	11.0
P _{O(SAT)1}	Saturated RF Output Power,	f _{RFout} = 0.9 GHz, P _{IFin} = 0 dBm	dBm	-2.5	–
P _{O(SAT)2}		f _{RFout} = 1.9 GHz, P _{IFin} = 0 dBm	dBm	-3.5	–
P _{O(SAT)3}		f _{RFout} = 2.4 GHz, P _{IFin} = 0 dBm	dBm	-4.0	–
OIP ₃₁	Output Third-Order Distortion Intercept Point,	f _{RFout} = 0.9 GHz	dBm	–	–
OIP ₃₂		f _{RFout} = 1.9 GHz			
OIP ₃₃		f _{RFout} = 2.4 GHz			
IIP ₃₁	Input Third-Order Distortion Intercept Point,	f _{RFout} = 0.9 GHz	dBm	–	–
IIP ₃₂		f _{RFout} = 1.9 GHz			
IIP ₃₃		f _{RFout} = 2.4 GHz			
SSB·NF1	SSB Noise Figure,	f _{RFout} = 0.9 GHz, f _{IFin} = 240 MHz	dB	–	–
SSB·NF2		f _{RFout} = 1.9 GHz, f _{IFin} = 240 MHz	dB	–	–
SSB·NF3		f _{RFout} = 2.4 GHz, f _{IFin} = 240 MHz	dB	–	–
TPS(rise)	Power Save Response Time	Rise Time, V _{PS} : GND' V _{CC}	μs	–	–
TPS(fall)		Fall Time, V _{PS} : V _{CC} ' GND	μs	–	–

Note:

1. f_{RFout} < f_{LOin} @ f_{RFout} = 0.9 GHz
f_{LOin} < f_{RFout} @ f_{RFout} = 1.9 GHz/2.4 GHz

BLOCK DIAGRAM

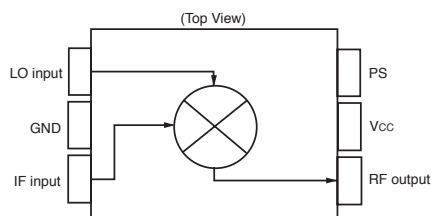

APPLICATIONS

- PCS1900 MHz
- 2.4 GHz band transmitter/receiver system (wireless LAN, etc.)

UPC8172TB

ABSOLUTE MAXIMUM RATINGS¹

(T_A = +25°C unless otherwise specified)

SYMBOLS	PARAMETERS	UNITS	RATINGS
V _{CC}	Supply Voltage	V	3.6
V _{PS}	PS Pin Input Voltage	V	3.6
P _D	Power Dissipation ²	mW	270
T _A	Operating Ambient Temperature	°C	-40 to +85
T _{STG}	Storage Temperature	°C	-55 to +150
P _{IN}	Input Power	dBm	+10

Notes:

- Operation in excess of any one of these conditions may result in permanent damage.
- Mounted on a double-sided copper clad 50x50x1.6 mm epoxy glass PWB, T_A = +85°C.

RECOMMENDED OPERATING CONDITIONS

SYMBOLS	PARAMETERS	UNITS	MIN	TYP	MAX
V _{CC}	Supply Voltage ¹	V	2.7	3.0	3.3
T _A	Operating Ambient Temperature	°C	-40	+25	+85
P _{LOin}	Local Input Level ²	dBm	-10	-5	0
f _{RFout}	RF Output Frequency ³	GHz	0.8	–	2.5
f _{iFin}	IF Input Frequency	MHz	50	–	400

Note:

- Same voltage applied to pins 5 and 6.
- Z_s = 50 Ω (without matching).
- With external matching circuit.

SERIES PRODUCTS¹ (T_A = +25°C, V_{CC} = V_{RFout} = 3.0 V, Z_S = Z_L = 50 Ω)

Part Number	I _{CC} (mA)	f _{RFout} (GHz)	CG (dB)			OIP ₃ (dBm)		
			@RF 0.9 GHz ²	@RF 1.9 GHz	@RF 2.4 GHz	@RF 0.9 GHz ²	@RF 1.9 GHz	@RF 2.4 GHz
UPC8172TB	9	0.8 to 2.5	9.5	8.5	8.0	+7.5	+6.0	+4.0
UPC8106TB	9	0.4 to 2.0	9	7	–	+5.5	-1.0	–
UPC8109TB	5	0.4 to 2.0	6	4	–	+1.5	+2.0	–
UPC8163TB	16.5	0.8 to 2.0	9	5.5	–	+9.5	+6.0	–

Notes:

- Typical performance.
- f_{RFout} = 0.83 GHz @ UPC8163TB

PIN FUNCTIONS (Voltage is measured at V_{CC} = V_{PS} = V_{RFOUT} = 3.0 V)

Pin No.	Pin Name	Applied Voltage (V)	Pin Voltage (V)	Function and Explanation	Equivalent Circuit						
1	IFinput	–	1.4	This pin is the IF input pin to the double balanced mixer (DBM). The input is designed as a high impedance. The circuit helps suppress spurious signals. Also this symmetrical circuit can keep specified performance insensitive to process-condition distribution. For that reason, a double balanced mixer is adopted.							
2	GND	GND	–	GND pin. Ground pattern on the board should be formed as wide as possible. Track length should be kept as short as possible to minimize ground inductance.							
3	LOinput	–	2.3	Local input pin. Recommendable input level is -10 to 0 dBm.							
5	V _{CC}	2.7 to 3.3	–	Supply voltage pin.							
6	RFoutput	Same bias as V _{CC} through external inductor	–	This pin is the RF output from the double balanced mixer. This pin is designed as an open collector. Due to the high impedance output, this pin should be externally equipped with an LC matching circuit to the next stage.							
4	PS	V _{CC} /GND		Power save control pin. Bias controls operate as follows: <table border="1" style="margin: 10px auto;"> <thead> <tr> <th>Pin Bias</th> <th>Control</th> </tr> </thead> <tbody> <tr> <td>V_{CC}</td> <td>Operation</td> </tr> <tr> <td>GND</td> <td>Power Save</td> </tr> </tbody> </table>	Pin Bias	Control	V _{CC}	Operation	GND	Power Save	
Pin Bias	Control										
V _{CC}	Operation										
GND	Power Save										

TYPICAL PERFORMANCE CURVES (TA = 25°C)

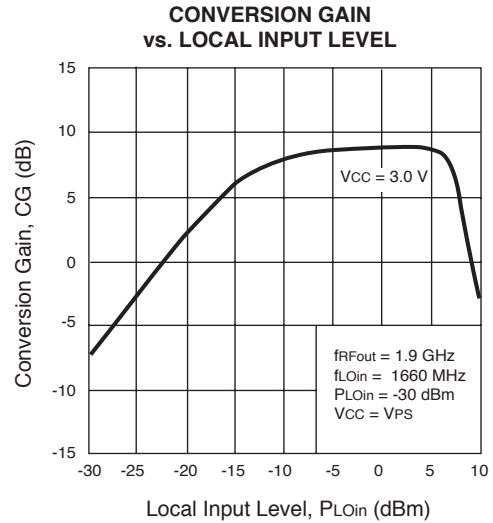
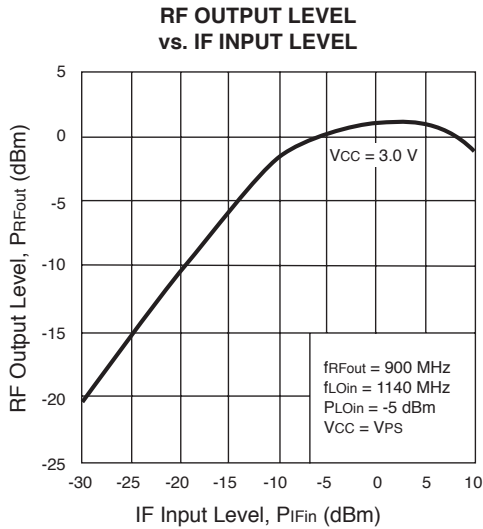
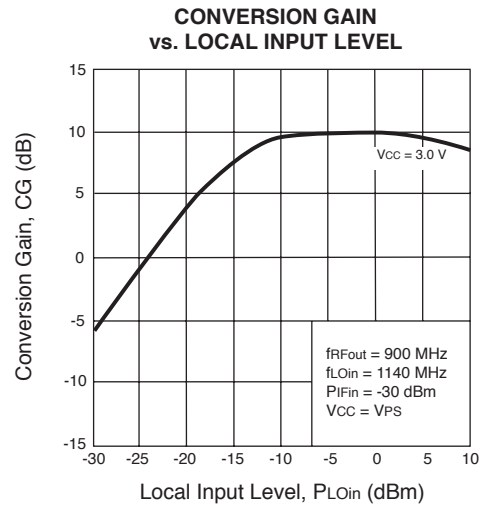
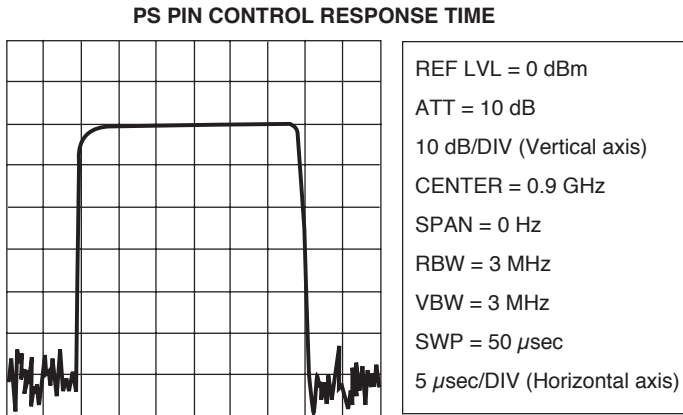
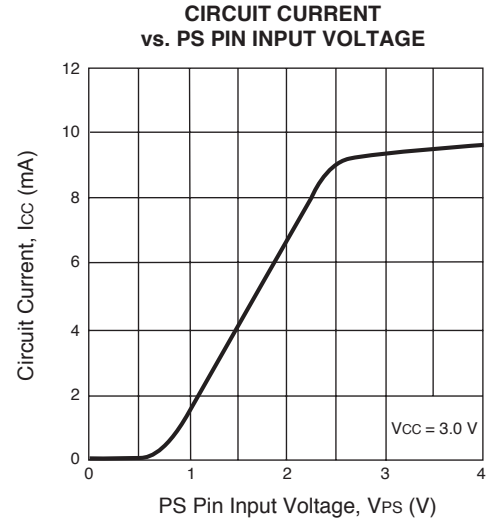
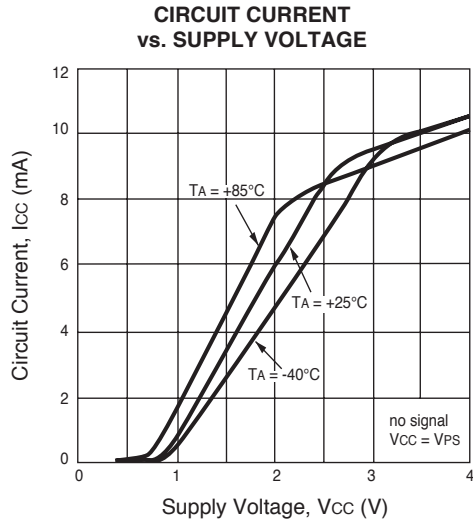

TYPICAL PERFORMANCE CURVES (TA = 25°C)

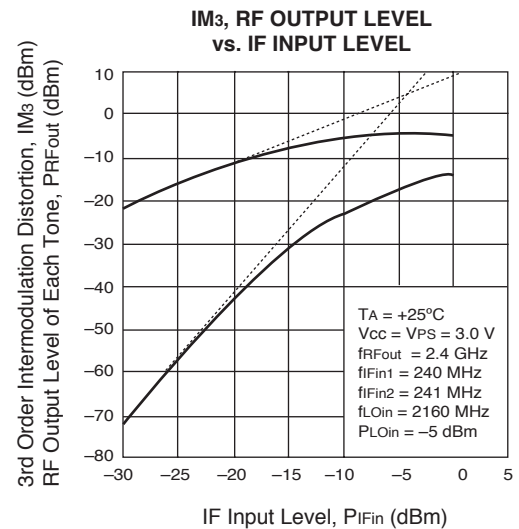
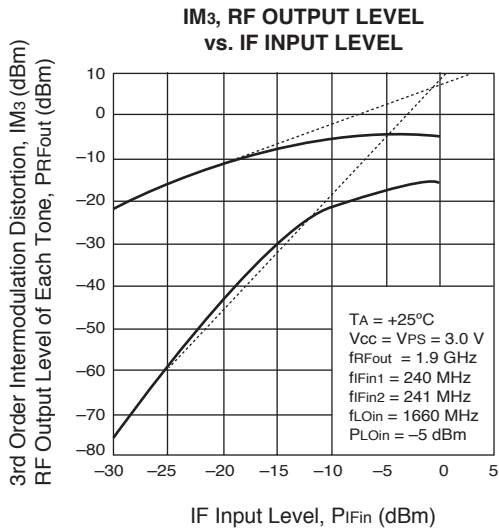
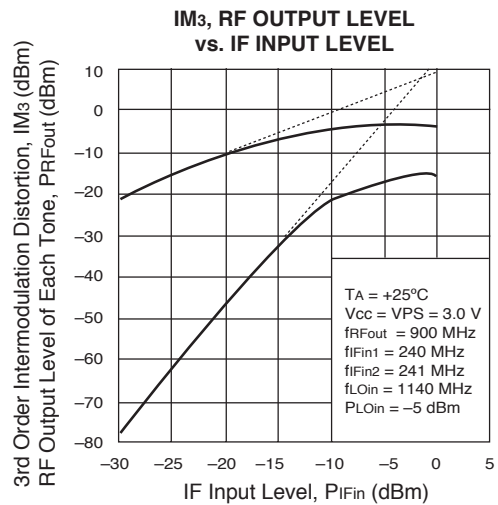
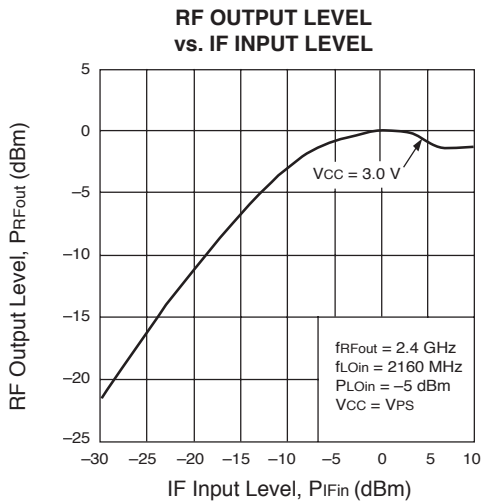
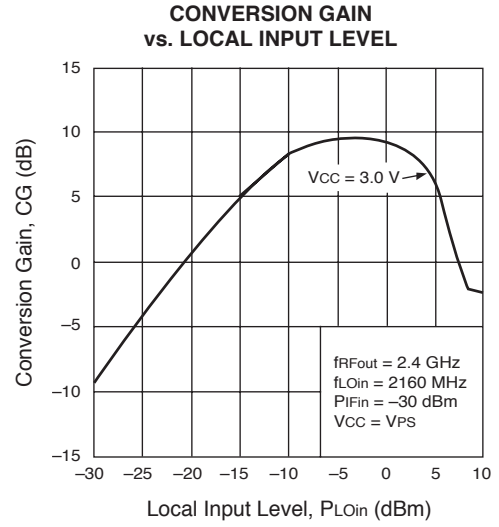
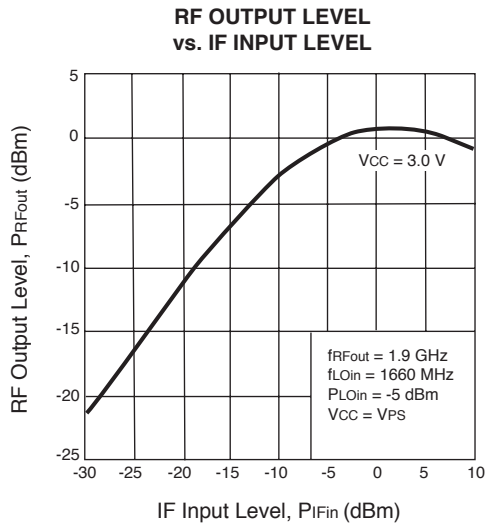

TYPICAL PERFORMANCE CURVES (TA = 25°C)

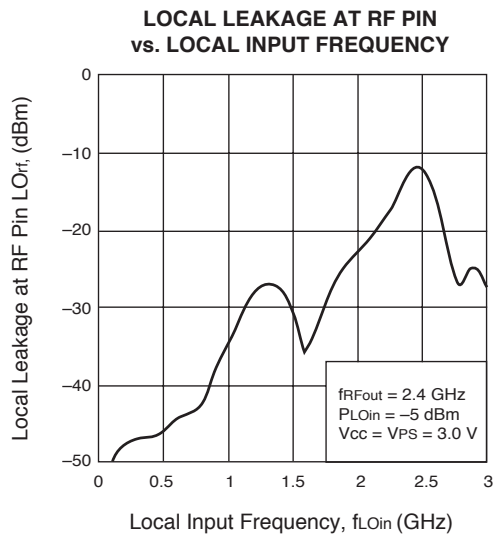
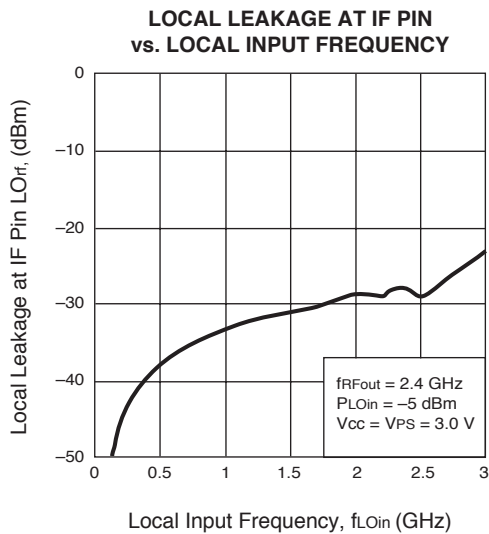
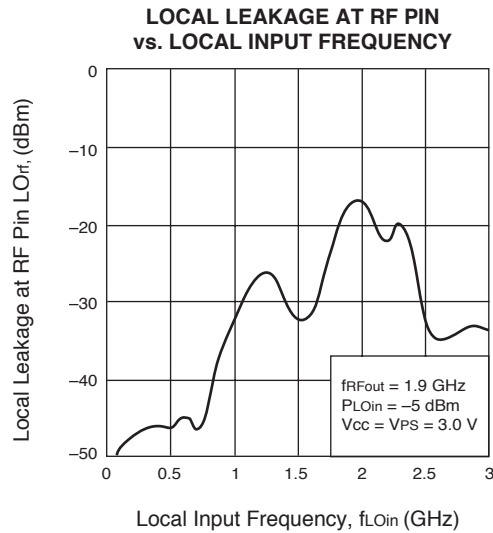
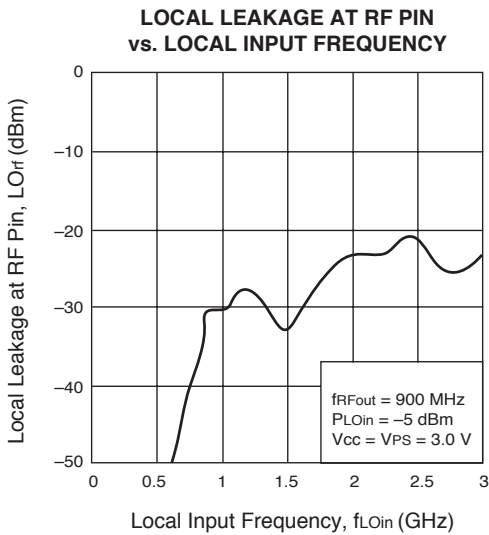
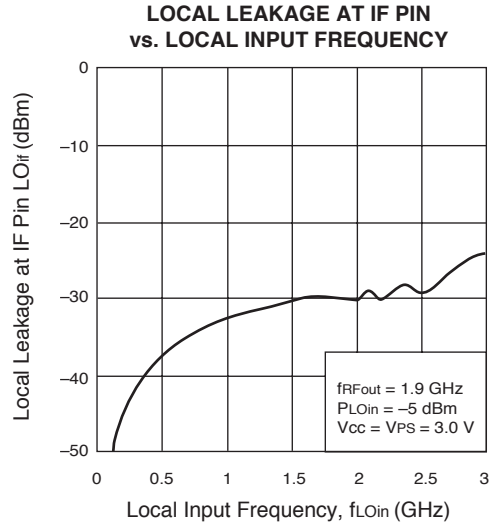
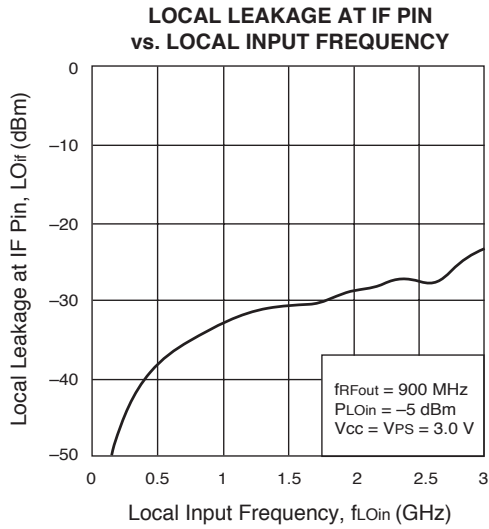

UPC8172TB

SYSTEM APPLICATION EXAMPLE

Wireless Transceiver

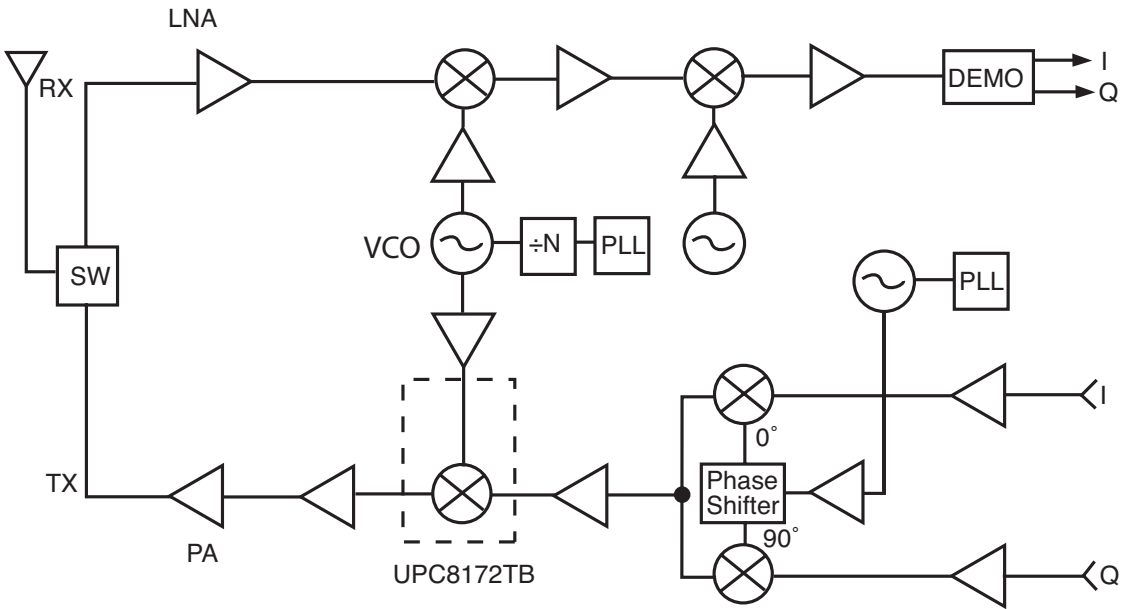

S-PARAMETERS FOR EACH PORT ($V_{CC} = V_{PS} = V_{RFout} = 3.0\text{ V}$)

(The paramters are monitored at DUT pins)

LO port

S₁₁ Z
 REF 1.0 Units
 1 200.0 mUnits/
 ▽ 21.625 Ω -91.148 Ω

hp
 MARKER 1
 1.15 GHz
 MARKER 2
 1.65 GHz
 MARKER 3
 2.15 GHz

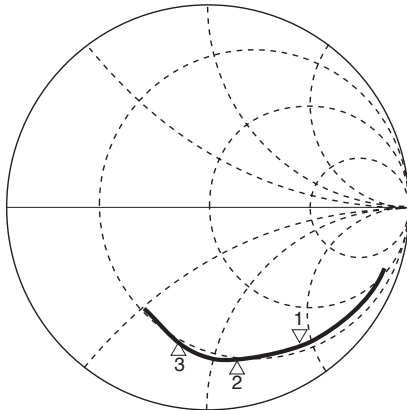

START 0.400000000 GHz
 STOP 2.500000000 GHz

RF port (without matching)

S₂₂ Z
 REF 1.0 Units
 1 200.0 mUnits/
 ▽ 71.5 Ω -240.34 Ω

hp
 MARKER 1
 900 MHz
 MARKER 2
 1.9 GHz
 MARKER 3
 2.5 GHz

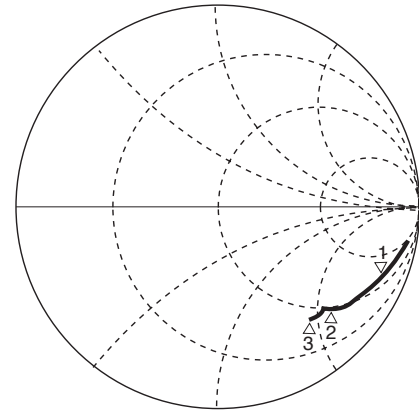

START 0.400000000 GHz
 STOP 2.500000000 GHz

IF port

S₁₁ Z
 REF 1.0 Units
 1 200.0 mUnits/
 ▽ 332.63 Ω -601.34 Ω

hp
 MARKER 1
 240.0 MHz

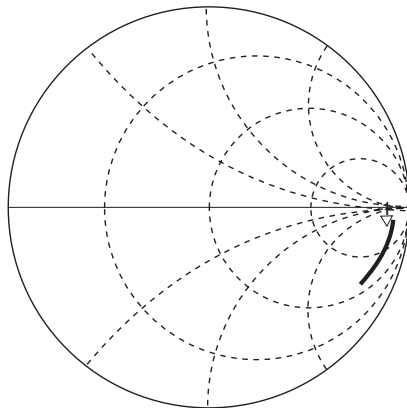

START 0.100000000 GHz
 STOP 1.000000000 GHz

TEST CIRCUIT 1 ($f_{RFout} = 900 \text{ MHz}$)

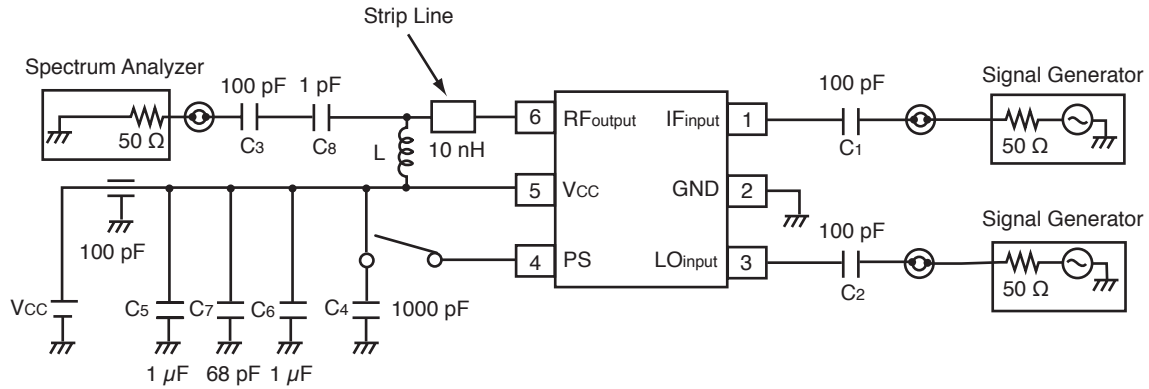

EXAMPLE OF TEST CIRCUIT 1 ASSEMBLED ON EVALUATION BOARD

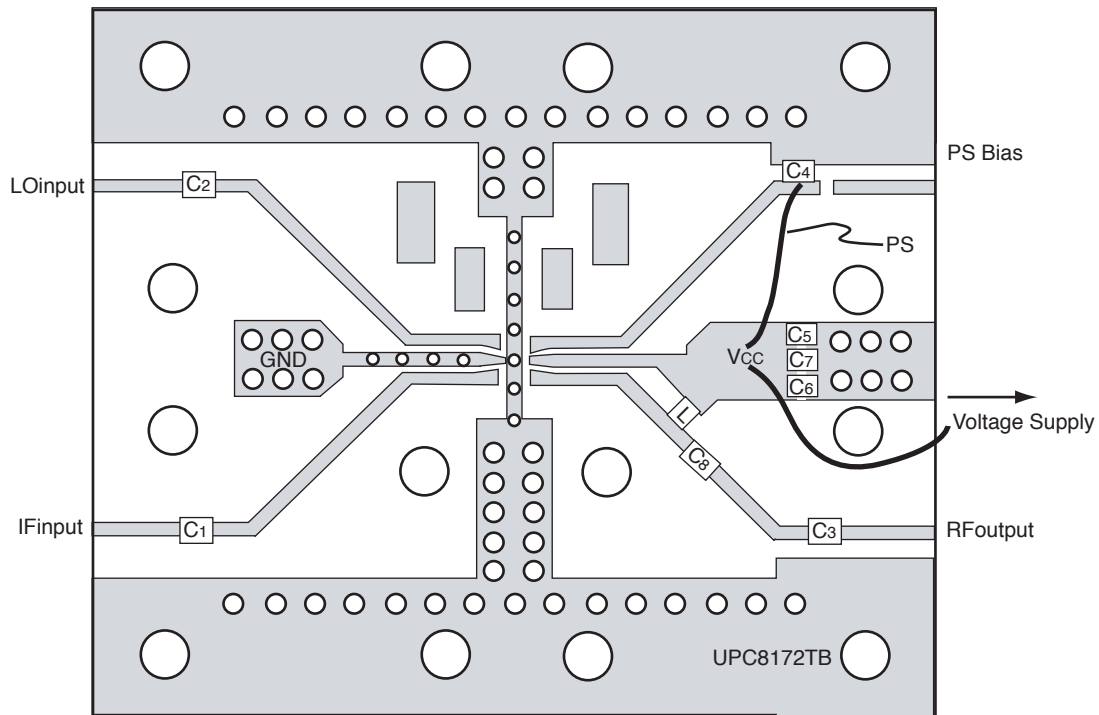

COMPONENT LIST

FORM	SYMBOL	VALUE
Chip Capacitor	C1, C2, C3	100 pF
	C4	1000 pF
	C5, C6	1 μF
	C7	68 pF
	C8	1 pF
	Chip Inductor	L

- (*1) 35x42x0.4 mm polymide board, double-sided copper clad
- (*2) Ground pattern on rear of the board
- (*3) Solder plated patterns
- (*4) mmIII : Through holes

Note:

1. 10 nH: LL1608-FH10N (TOKO Co., Ltd.)

TEST CIRCUIT 2 ($f_{RFout} = 1.9\text{ GHz}$)

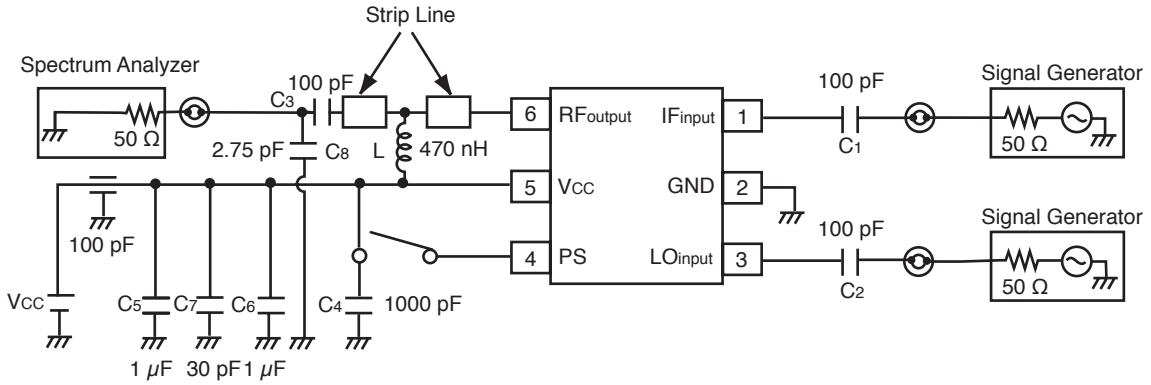

EXAMPLE OF TEST CIRCUIT 2 ASSEMBLED ON EVALUATION BOARD

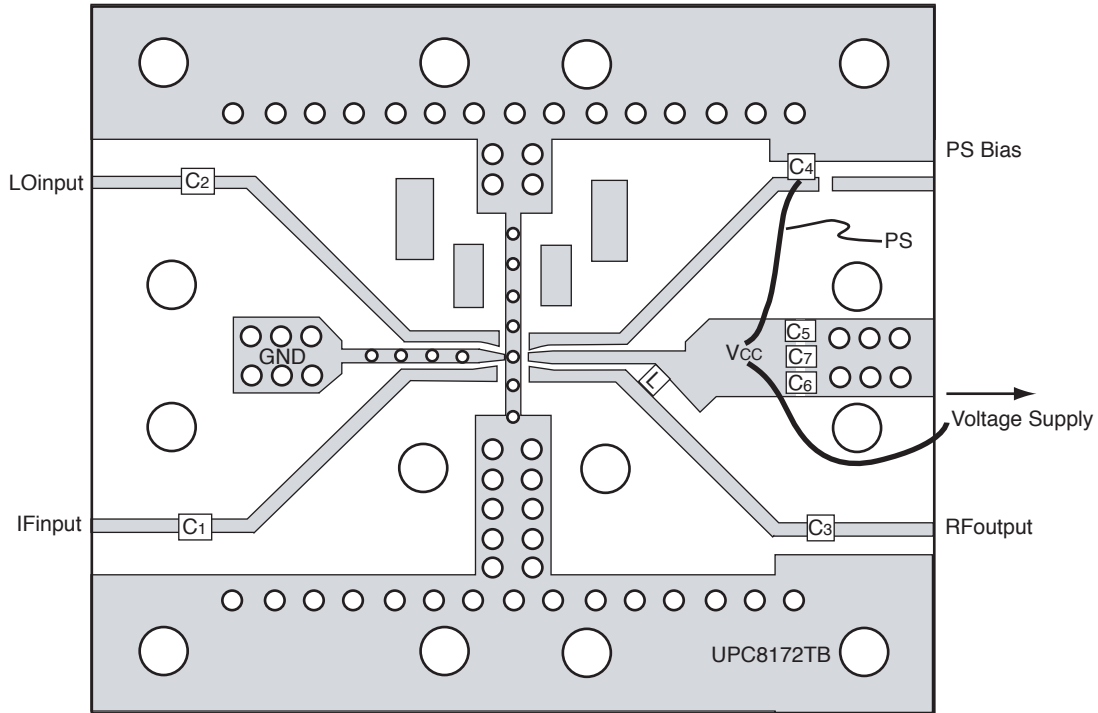

COMPONENT LIST

FORM	SYMBOL	VALUE
Chip Capacitor	C1, C2, C3	100 pF
	C4	1000 pF
	C5, C6	1 μF
	C7	30 pF
	C8	2.75 pF
Chip Inductor	L	470 nH ¹

- (*1) 35 x 42 x 0.4 mm polyimide board, double-sided copper clad
- (*2) Ground pattern on rear of the board
- (*3) Solder plated patterns
- (*4) mm∅: Through holes

Note:

1. 470 nH: LL2012-FR47 (TOKO Co., Ltd.)

TEST CIRCUIT 3 ($f_{RFout} = 2.4 \text{ GHz}$)

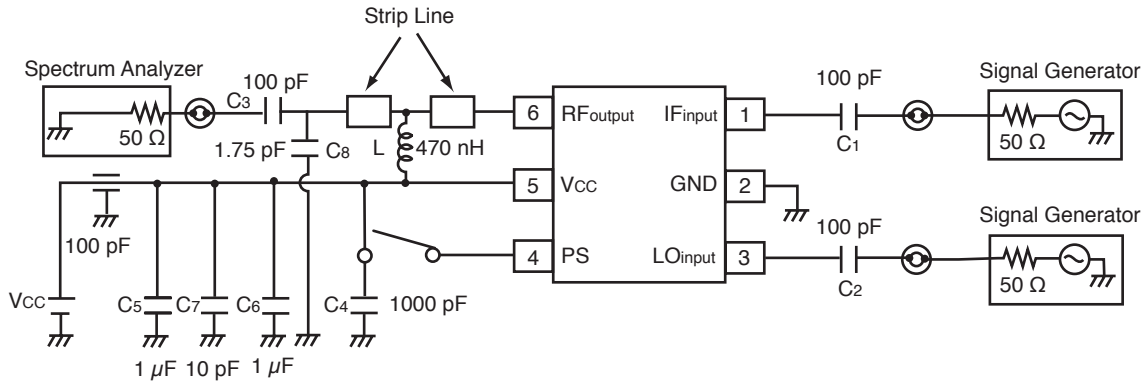

EXAMPLE OF TEST CIRCUIT 3 ASSEMBLED ON EVALUATION BOARD

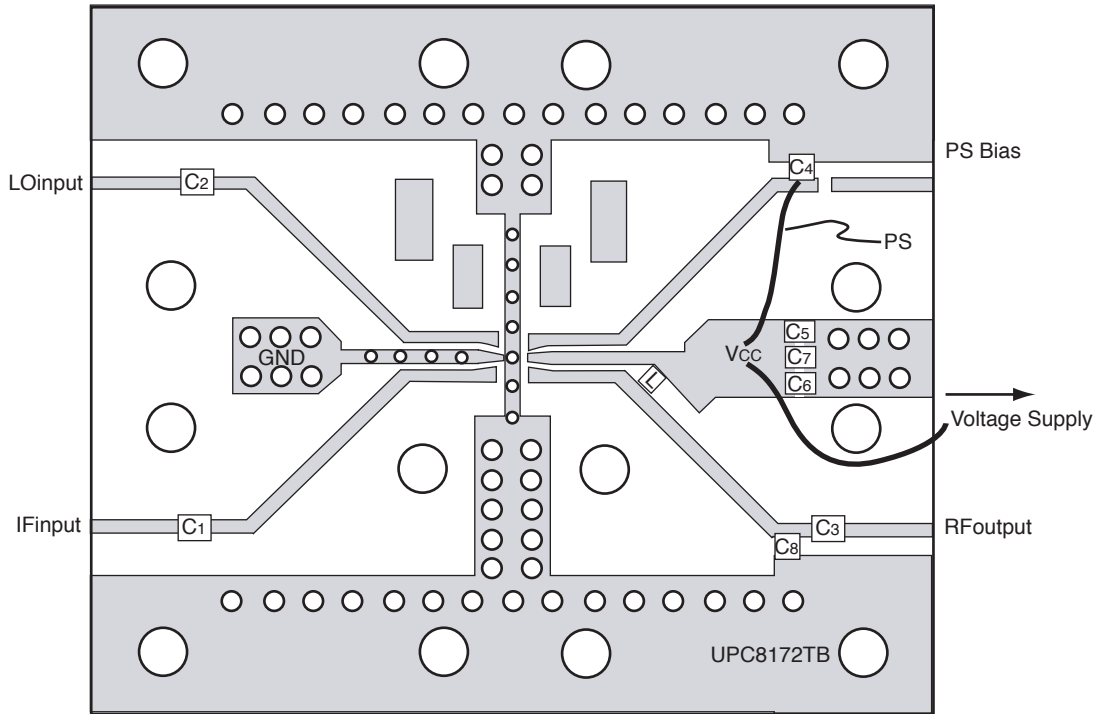

COMPONENT LIST

FORM	SYMBOL	VALUE
Chip Capacitor	C1, C2, C3	100 pF
	C4	1000 pF
	C5, C6	1 μ F
	C7	10 pF
	C8	1.75 pF
	Chip Inductor	L

- (*1) 35 x 42 x 0.4 mm polyimide board, double-sided copper clad
- (*2) Ground pattern on rear of the board
- (*3) Solder plated patterns
- (*4) mmM : Through holes

Note:

1. 470 nH: LL2012-FR47 (TOKO Co., Ltd.)

OUTLINE DIMENSIONS (Units in mm)

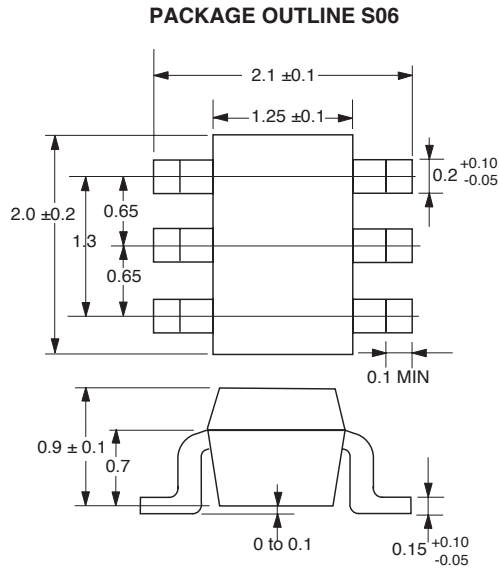

Note:
 All dimensions are typical unless otherwise specified.

BLOCK DIAGRAM

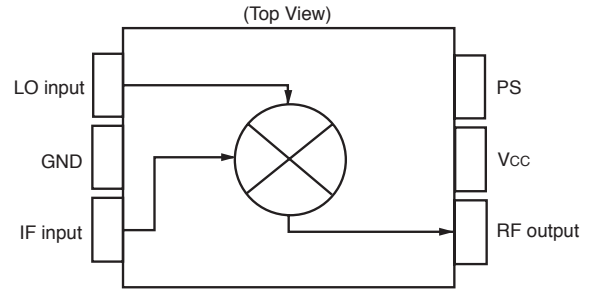

PIN CONNECTIONS

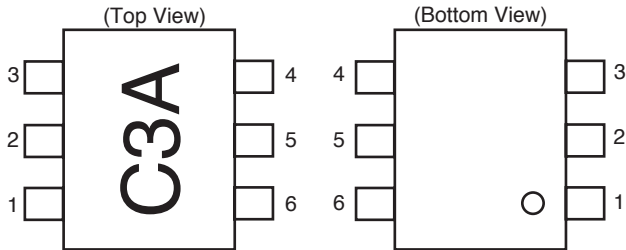

PIN NO.	PIN NAME
1	IFinput
2	GND
3	LOinput
4	PS
5	Vcc
6	RFoutput

ORDERING INFORMATION

Part Number	Quantity
UPC8172TB-E3-A	3 K pcs/reel

Note: Embossed tape, 8 mm wide. Pins 1, 2 and 3 face the tape perforation side.

EXCLUSIVE NORTH AMERICAN AGENT FOR RF, MICROWAVE & OPTOELECTRONIC SEMICONDUCTORS

CEL CALIFORNIA EASTERN LABORATORIES • Headquarters • 4590 Patrick Henry Drive • Santa Clara, CA 95054-1817 • (408) 988-3500 • Telex 34-6393 • FAX (408) 988-0279
 24-Hour Fax-On-Demand: 800-390-3232 (U.S. and Canada only) • Internet: <http://WWW.CEL.COM>

DATA SUBJECT TO CHANGE WITHOUT NOTICE

06/14/2001



Компания «ЭлектроПласт» предлагает заключение долгосрочных отношений при поставках импортных электронных компонентов на взаимовыгодных условиях!

Наши преимущества:

- Оперативные поставки широкого спектра электронных компонентов отечественного и импортного производства напрямую от производителей и с крупнейших мировых складов;
- Поставка более 17-ти миллионов наименований электронных компонентов;
- Поставка сложных, дефицитных, либо снятых с производства позиций;
- Оперативные сроки поставки под заказ (от 5 рабочих дней);
- Экспресс доставка в любую точку России;
- Техническая поддержка проекта, помощь в подборе аналогов, поставка прототипов;
- Система менеджмента качества сертифицирована по Международному стандарту ISO 9001;
- Лицензия ФСБ на осуществление работ с использованием сведений, составляющих государственную тайну;
- Поставка специализированных компонентов (Xilinx, Altera, Analog Devices, Intersil, Interpoint, Microsemi, Aeroflex, Peregrine, Syfer, Eurofarad, Texas Instrument, Miteq, Cobham, E2V, MA-COM, Hittite, Mini-Circuits, General Dynamics и др.);

Помимо этого, одним из направлений компании «ЭлектроПласт» является направление «Источники питания». Мы предлагаем Вам помощь Конструкторского отдела:

- Подбор оптимального решения, техническое обоснование при выборе компонента;
- Подбор аналогов;
- Консультации по применению компонента;
- Поставка образцов и прототипов;
- Техническая поддержка проекта;
- Защита от снятия компонента с производства.



Как с нами связаться

Телефон: 8 (812) 309 58 32 (многоканальный)

Факс: 8 (812) 320-02-42

Электронная почта: org@eplast1.ru

Адрес: 198099, г. Санкт-Петербург, ул. Калинина, дом 2, корпус 4, литера А.