

SERIES 53, 57 and 59
1.125" Diameter, 1/4 Amp

FEATURES

- Smallest Diameter Rotary Switch with this Number of Positions and Current Capacity
- Military Qualified MIL-DTL-3786/36
- Gold-plated Contact System Compatible with Logic Circuitry



DIMENSIONS in inches (and millimeters)

Military Style

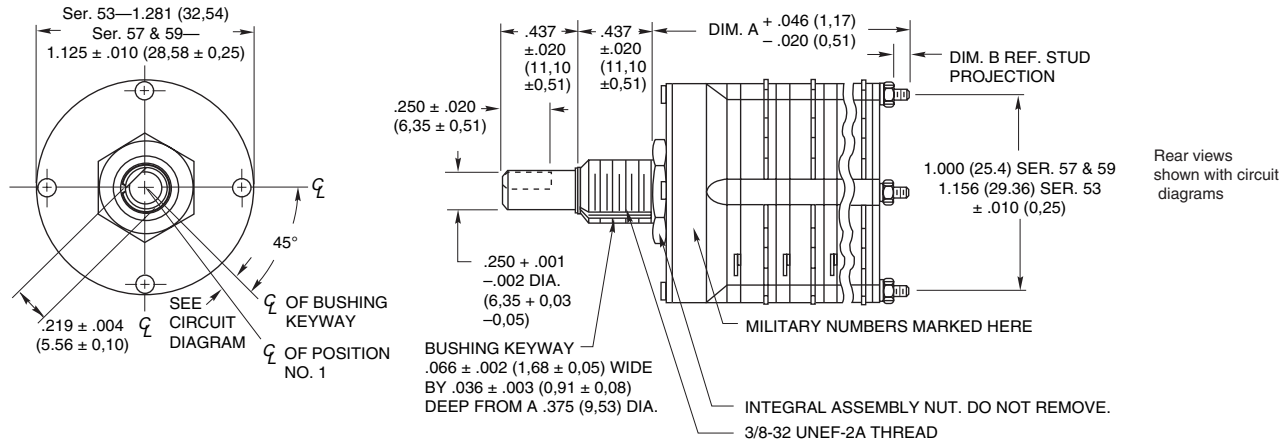

No. of Decks	Dimension A	Dimension B	Approx. Weight Grams	No. of Decks	Dimension A	Dimension B	Approx. Weight Grams
1	.916 (23,27)	.032 (0,81)	50	7	3.164 (80,37)	.281 (7,14)	110
2	1.249 (31,72)	.032 (0,81)	60	8	3.497 (88,82)	.281 (7,14)	120
3	1.582 (40,18)	.032 (0,81)	70	9	3.830 (97,28)	.281 (7,14)	130
4	1.915 (48,64)	.032 (0,81)	80	10	4.163 (105,74)	.281 (7,14)	140
5	2.248 (57,10)	.032 (0,81)	90	11	4.496 (114,20)	.281 (7,14)	150
6	2.831 (71,91)	.281 (7,14)	100	12	4.829 (122,66)	.281 (7,14)	160

Mounting Hardware: Two mounting nuts, .094" (2,39) thick by .562" (14,27) across flats, one internal tooth lockwasher and one non-turn washer (see detail D for dimensions), are supplied with switch. Grayhill part number and date code marked on detent cover label. Customer part number marked on request. Military part number marked when required.

Non-Turn Washer Detail D

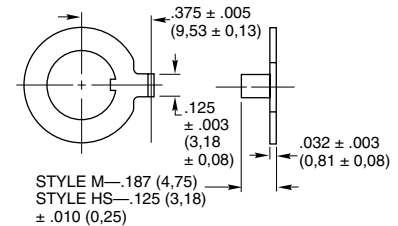

STANDARD STYLE MILITARY QUALIFIED

The Series 53, 57 and 59 rotary switches are all military type switches. Grayhill manufactures these switches in two styles: M and HS. Style M is unsealed and is *not* qualified; Style HS is shaft and panel sealed and *is* qualified. The non-qualified Style M can be regarded as our Standard Style for types of switches. Although it is not qualified, Style M is constructed of the same military grade materials and will provide comparable performance in all areas. For example, the Style 'M' switches, in addition to the electrical ratings listed elsewhere in these pages, will meet the following requirements of MIL-DTL-3786:

Moisture Resistance: Medium and High Shock; Vibration (10 to 500 cps); Thermal Shock (-65 °C to 125 °C); Salt Spray; Explosion; Terminal Strength (pull, 2 lbs. minimum); and Stop Strength (15 pound-inches minimum).

The line drawings shown above are applicable to the Style M and Style HS. The only difference between the two is the length of the tab of the non-turn washer. The shorter tab for the HS is explained in the following paragraph.

The Series 53, 57 and 59 Style HS rotary switches are qualified to MIL-DTL-3786/36. The Style HS is shaft and panel sealed. The panel is sealed by an O-ring at the base of the bushing. The shaft is sealed by an O-ring inside the bushing. These seals do not alter the dimensions shown in the line drawings when the switch is mounted.

A non-turn washer, supplied with the mounting hardware, may be used with the Style HS switches. It is suggested that the non-turn washer be mounted in the following manner to preserve the seal: from the front of the panel into a hole that does not go through the panel.

The qualification of the Series 53, 57 and

59 rotary switches does not extend to all possible combinations listed in the Choices and Limitations chart. The limitations on the qualification are described in the chart shown below.

Standard variations, such as shaft and/or bushing length, etc., that do not affect switch performance can also be marked as qualified product. For complete details contact Grayhill. Military qualified Series 53, 57 and 59 Style HS rotary switches may be ordered by the 'M' number listed in MIL-DTL-3786/36 or by the Grayhill part number. Military style switches will be marked to the specification.

Style HS Switches are MIL-DTL-3786/36 Qualified for the Following Characteristics

Series	Max. No. of Decks	Max. No. Poles/Deck	Max. No. Total Poles/Switch
53	5	8	24
57	5	4	16
59	5	5	20

CIRCUIT DIAGRAMS: Series 53

Switch is Viewed From Shaft End and Shown in Position No. 1

Note: All common terminals are located above base terminals as shown.

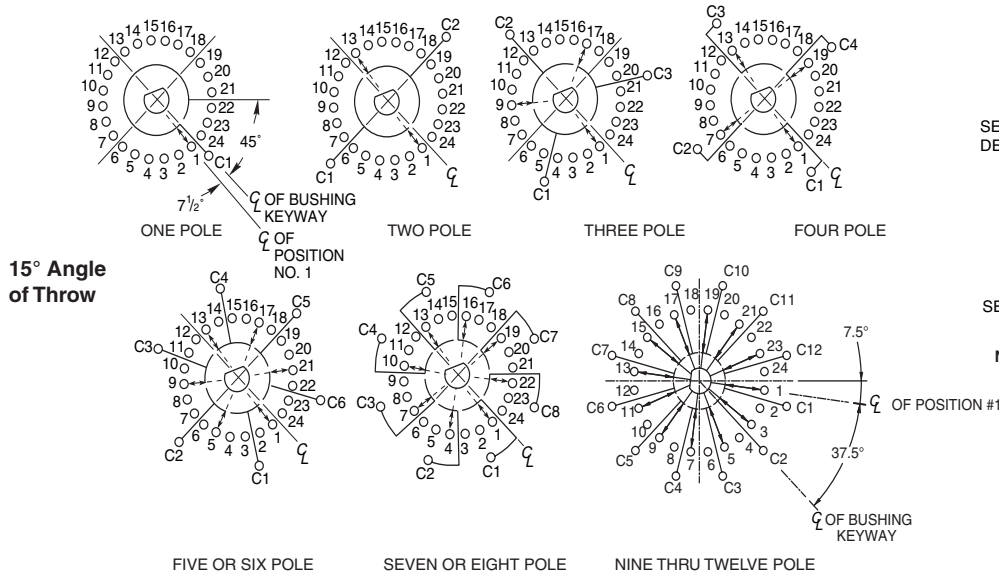

Rear View

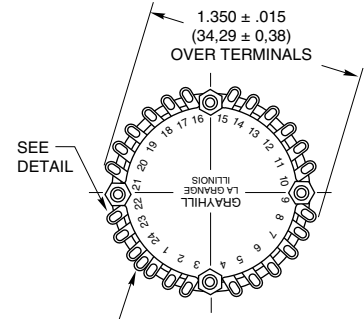

Note: Common location for a single pole per deck switch. For common location on multipole switches see circuit diagrams.

Terminal Detail

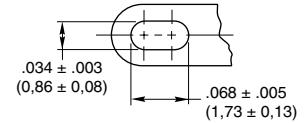

CIRCUIT DIAGRAMS: Series 59

Switch is Viewed From Shaft End and Shown in Position No. 1

Note: All common terminals are located above base terminals as shown.

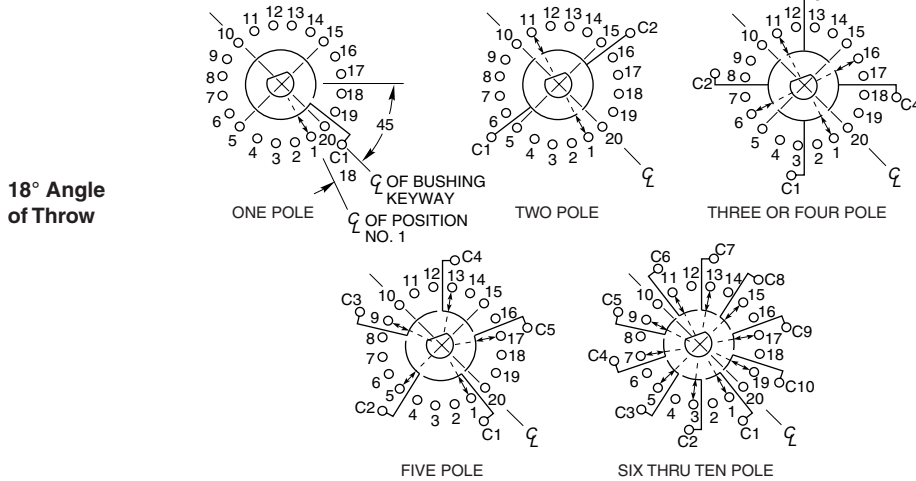

Rear View

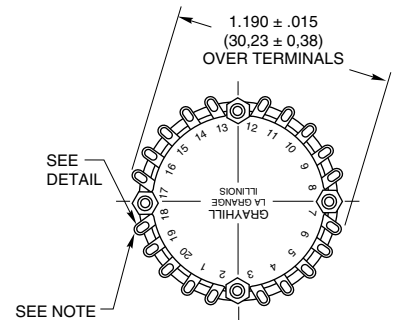

Note: Common location for a single pole per deck switch. For common location on multipole switches see circuit diagrams.

CIRCUIT DIAGRAMS: Series 57



SPECIFICATIONS

Electrical Ratings

General

Switch rating for break before make contacts.

Voltage: As listed in the chart.



Curve data based on test data conducted at sea level, 25°C and relative humidity. Cycle equals 360° rotation and 360° return. Cycling rate is 10 cycles per minute. The curves shown are typical load life curves for a Series 53M, 57M and 59M Rotary Switch. They show the number of cycles of rotational life that can be expected for the voltages, currents and types of loads shown. Thus, with a 250 milliamperes, 30 Vdc resistive load, 10,000 cycles of life can be expected. Life limiting or failure criteria for these curves are:

Contact Resistance: 50 milliohms maximum (20 milliohms initially).

Insulation Resistance: 1,000 megohms minimum between mutually insulated parts.

Voltage Breakdown: 500Vac minimum between mutually insulated parts. These switches will carry 4 amperes with a maximum contact temperature rise of 20°C. If the life limiting characteristics are less critical than those shown above or if elevated temperatures or reduced pressures are involved, Grayhill can predict the switch life for the application.

Electrical Ratings Military Qualified

The Series 53, 57 and 59 Style HS, Rotary Switches have been tested to make and break the following loads as stated in MIL-DTL-3786/36: 70,000 ft. altitude for 10,000 cycles: 10mA, 28 Vdc, inductive (250 mH); 50 mA, 28 Vdc, resistive; 20mA, 115Vac, resistive. Atmospheric pressure, 125°C for 10,000 cycles: 25 mA, 28 Vdc inductive (250 mH); 75 mA, 28 Vdc, resistive; 50 mA, 115 Vac resistive. Atmospheric pressure, 25°C for 10,000 cycles: 75 mA, 28 Vdc, inductive (250 mH); 250 mA, 28 Vdc resistive; 150 mA, 115 Vac, resistive. Life limiting criteria for these loads are:

Contact Resistance: 50 milliohms maximum.

Dielectric Strength: 500Vac (350Vac—reduced pressure).

Insulation Resistance: 1,000 megohms minimum. These switches also meet MIL-DTL-3786/36 for moisture resistance, medium and high shock, vibration, thermal, thermal shock, salt spray, explosion, terminal strength and stop strength.

Materials and Finishes

Cover, Base, Spacer and Rotor Mounting Plate: Diallyl per (MIL-M-14) ASTM-D-5948

Mounting Bushing: Brass, tin/zinc-plated.

Shaft, Stop Pins, Retaining Rings, Through Bolts, Shaft Extension, Stop Arm, Thrust Washers, Lockwashers, Nuts, Non-turn Washer, Cover Plate and Rear Support Plate: Stainless steel

Detent Balls: Steel, nickel-plated

Detent Springs: Tinned music wire

Rotor Contact: Silver alloy, gold-plated .00001" minimum.

Terminals and Common Plate Including Solder Lug: Brass, gold plate .00002" minimum over silver plate .0003" minimum.

Panel Seal: Silicone rubber.

Shaft Seal: O-ring per MIL-M-5516B.

Mounting Nut, Lock Washer: Brass, tin/zinc-plated or stainless steel.

Additional Characteristics

Rotational Torque: 20-80 in.-ozs., depending on the number of poles per deck and the number of decks.

Contacts: Shorting or non-shorting wiping contacts with over 100 grams of contact force.

Shaft Flat Orientation: Flat opposite contacting position pole #1 (See Circuit Diagrams).

Extended Studs: Switches of 6 decks or more have longer studs with extra stud nuts for recommended double end mounting.

Terminals: Switch is provided with full complement of base or position terminals regardless of the number of active positions.

CHOICES AND LIMITATIONS

Series	Style and Designation	Angle of Throw	Stops	Terminals	Number of Decks		Poles Per Deck	Number of Positions/Pole
					Shorting	Non-Shorting		
53	M = Military Style HS = Military Qualified, Shaft/Panel Seal	15°	Fixed	Solder Lug	01 thru 12	01 thru 12	1	02 thru 24
					01 thru 12	01 thru 12	2	02 thru 12
					01 thru 08	01 thru 08	3	02 thru 08
					01 thru 06	01 thru 06	4	02 thru 06
					01 thru 04	01 thru 04	5 or 6	02 thru 04
					01 thru 03	01 thru 03	7 or 8	02 or 03
01 or 02	01 or 02	9, 10, 11 or 12	02					
57	M = Military Style HS = Military Qualified, Shaft/Panel Seal	22 1/2°	Fixed	Solder Lug	01 thru 12	01 thru 12	1	02 thru 16
					01 thru 12	01 thru 12	2	02 thru 08
					01 thru 06	01 thru 06	3 or 4	02 thru 04
					01 thru 03	01 thru 03	5, 6, 7 or 8	02
59	M = Military Style HS = Military Qualified, Shaft/Panel Seal	18°	Fixed	Solder Lug	01 thru 12	01 thru 12	1	02 thru 20
					01 thru 12	01 thru 12	2	02 thru 10
					01 thru 06	01 thru 06	3 or 4	02 thru 05
					01 thru 04	01 thru 04	5	02 thru 04
					01 or 02	01 or 02	6, 7, 8, 9 or 10	02

MIL Spec. provides for qualification up to and including five decks. Switches of longer length, although not specifically qualified, are built of the same materials and are of the same construction.

ORDERING INFORMATION

Series

Style*: Letter(s) from the Choices and Limitations chart

Angle of Throw: Must agree with Series Number

Number of Decks: As limited by Choices and Limitations chart

57M22-01-1-16N-F

Stop Arrangement: Use suffix only when ordering 1 pole with maximum positions.
F = Stop between last and first positions; C = Continuous Rotation

Type of Contacts: N = Non-shorting; S = Shorting

Positions Per Pole: requires 02 as a minimum to the maximum allowable dependent on the angle of throw and poles per deck

Poles Per Deck: As limited by angle of throw

** All rotary switches that are required to have military designated markings and testing adhering to MIL-DTL-3786 are to be ordered by specifying the military part number identified on the appropriate slash sheet.*

Rotary Switches



Компания «ЭлектроПласт» предлагает заключение долгосрочных отношений при поставках импортных электронных компонентов на взаимовыгодных условиях!

Наши преимущества:

- Оперативные поставки широкого спектра электронных компонентов отечественного и импортного производства напрямую от производителей и с крупнейших мировых складов;
- Поставка более 17-ти миллионов наименований электронных компонентов;
- Поставка сложных, дефицитных, либо снятых с производства позиций;
- Оперативные сроки поставки под заказ (от 5 рабочих дней);
- Экспресс доставка в любую точку России;
- Техническая поддержка проекта, помощь в подборе аналогов, поставка прототипов;
- Система менеджмента качества сертифицирована по Международному стандарту ISO 9001;
- Лицензия ФСБ на осуществление работ с использованием сведений, составляющих государственную тайну;
- Поставка специализированных компонентов (Xilinx, Altera, Analog Devices, Intersil, Interpoint, Microsemi, Aeroflex, Peregrine, Syfer, Eurofarad, Texas Instrument, Miteq, Cobham, E2V, MA-COM, Hittite, Mini-Circuits, General Dynamics и др.);

Помимо этого, одним из направлений компании «ЭлектроПласт» является направление «Источники питания». Мы предлагаем Вам помощь Конструкторского отдела:

- Подбор оптимального решения, техническое обоснование при выборе компонента;
- Подбор аналогов;
- Консультации по применению компонента;
- Поставка образцов и прототипов;
- Техническая поддержка проекта;
- Защита от снятия компонента с производства.



Как с нами связаться

Телефон: 8 (812) 309 58 32 (многоканальный)

Факс: 8 (812) 320-02-42

Электронная почта: org@eplast1.ru

Адрес: 198099, г. Санкт-Петербург, ул. Калинина, дом 2, корпус 4, литера А.