

**3 Phase bridge  
Trench + Field Stop IGBT4  
Power Module**

**$V_{CES} = 1200V$   
 $I_C = 40A @ T_c = 80^\circ C$**

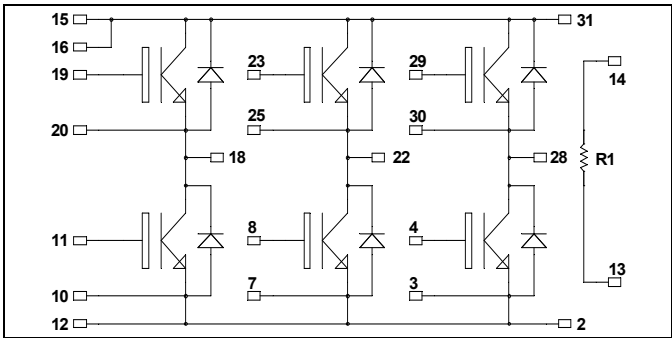

It is recommended to connect a decoupling capacitor between pins 31 & 2 to reduce switching overvoltages, if DC Power is connected between pins 15, 16 & 12. Pins 15 & 16 must be shorted together.

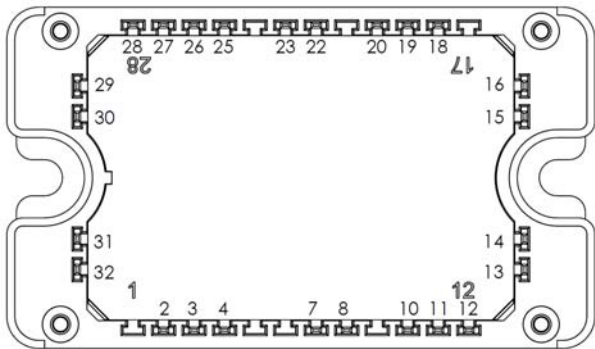

**Application**

- Motor control

**Features**

- **Trench + Field Stop IGBT 4**
  - Low voltage drop
  - Low leakage current
  - Low switching losses
  - Low tail current
  - RBSOA and SCSOA rated
- Kelvin emitter for easy drive
- Very low stray inductance
- Internal thermistor for temperature monitoring

**Benefits**

- Outstanding performance at high frequency operation
- Direct mounting to heatsink (isolated package)
- Low junction to case thermal resistance
- Solderable terminals both for power and signal for easy PCB mounting
- Low profile
- RoHS compliant

**All ratings @  $T_j = 25^\circ C$  unless otherwise specified**

**Absolute maximum ratings (per IGBT)**

Symbol	Parameter	Max ratings	Unit
$V_{CES}$	Collector - Emitter Voltage	1200	V
$I_C$	Continuous Collector Current	$T_C = 25^\circ C$	65
		$T_C = 80^\circ C$	40
$I_{CM}$	Pulsed Collector Current	$T_C = 25^\circ C$	70
$V_{GE}$	Gate - Emitter Voltage	$\pm 20$	V
$P_D$	Power Dissipation	$T_C = 25^\circ C$	220
RBSOA	Reverse Bias Safe Operating Area	$T_j = 150^\circ C$	70A @ 1100V

**CAUTION:** These Devices are sensitive to Electrostatic Discharge. Proper Handling Procedures Should Be Followed.

**Electrical Characteristics** (per IGBT)

Symbol	Characteristic	Test Conditions	Min	Typ	Max	Unit
I <sub>CES</sub>	Zero Gate Voltage Collector Current	V <sub>GE</sub> = 0V, V <sub>CE</sub> = 1200V			250	μA
V <sub>CE(sat)</sub>	Collector Emitter saturation Voltage	V <sub>GE</sub> = 15V I <sub>C</sub> = 35A		1.85 2.25	2.25	V
V <sub>GE(th)</sub>	Gate Threshold Voltage	V <sub>GE</sub> = V <sub>CE</sub> , I <sub>C</sub> = 1.2mA	5.0	5.8	6.5	V
I <sub>GES</sub>	Gate – Emitter Leakage Current	V <sub>GE</sub> = 20V, V <sub>CE</sub> = 0V			400	nA

**Dynamic Characteristics** (per IGBT)

Symbol	Characteristic	Test Conditions	Min	Typ	Max	Unit
C <sub>ies</sub>	Input Capacitance	V <sub>GE</sub> = 0V		1950		pF
C <sub>oes</sub>	Output Capacitance	V <sub>CE</sub> = 25V		155		
C <sub>res</sub>	Reverse Transfer Capacitance	f = 1MHz		115		
Q <sub>G</sub>	Gate charge	V <sub>GE</sub> = ±15V ; V <sub>CE</sub> = 600V I <sub>C</sub> = 35A		0.27		μC
T <sub>d(on)</sub>	Turn-on Delay Time	Inductive Switching (25°C) V <sub>GE</sub> = ±15V V <sub>CE</sub> = 600V I <sub>C</sub> = 35A R <sub>G</sub> = 12Ω		130		ns
T <sub>r</sub>	Rise Time			20		
T <sub>d(off)</sub>	Turn-off Delay Time			300		
T <sub>f</sub>	Fall Time			45		
T <sub>d(on)</sub>	Turn-on Delay Time	Inductive Switching (150°C) V <sub>GE</sub> = ±15V V <sub>CE</sub> = 600V I <sub>C</sub> = 35A R <sub>G</sub> = 12Ω		150		ns
T <sub>r</sub>	Rise Time			35		
T <sub>d(off)</sub>	Turn-off Delay Time			350		
T <sub>f</sub>	Fall Time			80		
E <sub>on</sub>	Turn-on Switching Energy	V <sub>GE</sub> = ±15V V <sub>CE</sub> = 600V		2.6 4		mJ
E <sub>off</sub>	Turn-off Switching Energy	I <sub>C</sub> = 35A R <sub>G</sub> = 12Ω		2 3		
I <sub>sc</sub>	Short Circuit data	V <sub>GE</sub> ≤ 15V ; V <sub>Bus</sub> = 900V t <sub>p</sub> ≤ 10μs ; T <sub>j</sub> = 150°C		140		A
R <sub>thJC</sub>	Junction to Case Thermal Resistance				0.68	°C/W

**Reverse diode ratings and characteristics** (per diode)

Symbol	Characteristic	Test Conditions	Min	Typ	Max	Unit
V <sub>RRM</sub>	Peak Repetitive Reverse Voltage				1200	V
I <sub>RM</sub>	Reverse Leakage Current	V <sub>R</sub> = 1200V			100	μA
I <sub>F</sub>	DC Forward Current	T <sub>c</sub> = 80°C		30		A
V <sub>F</sub>	Diode Forward Voltage	I <sub>F</sub> = 30A I <sub>F</sub> = 60A I <sub>F</sub> = 30A		2.6 3.2 1.8	3.1	V
t <sub>rr</sub>	Reverse Recovery Time	I <sub>F</sub> = 30A V <sub>R</sub> = 800V		300 380		ns
Q <sub>rr</sub>	Reverse Recovery Charge	di/dt = 200A/μs		360 1700		
R <sub>thJC</sub>	Junction to Case Thermal Resistance				1.2	°C/W

**Temperature sensor NTC** (see application note APT0406 on [www.microsemi.com](http://www.microsemi.com) for more information).

Symbol	Characteristic	Min	Typ	Max	Unit
R <sub>25</sub>	Resistance @ 25°C		50		kΩ
ΔR <sub>25</sub> /R <sub>25</sub>			5		%
B <sub>25/85</sub>	T <sub>25</sub> = 298.15 K		3952		K
ΔB/B	T <sub>C</sub> = 100°C		4		%

$$R_T = \frac{R_{25}}{\exp \left[ B_{25/85} \left( \frac{1}{T_{25}} - \frac{1}{T} \right) \right]}$$

T: Thermistor temperature  
 R<sub>T</sub>: Thermistor value at T

### Thermal and package characteristics

Symbol	Characteristic	Min	Max	Unit		
V <sub>ISOL</sub>	RMS Isolation Voltage, any terminal to case t = 1 min, 50/60Hz	4000		V		
T <sub>J</sub>	Operating junction temperature range	-40	175	°C		
T <sub>JOP</sub>	Recommended junction temperature under switching conditions	-40	T <sub>Jmax</sub> -25			
T <sub>STG</sub>	Storage Temperature Range	-40	125			
T <sub>C</sub>	Operating Case Temperature	-40	125			
Torque	Mounting torque	To heatsink	M4	2	3	N.m
Wt	Package Weight				110	g

### Package outline (dimensions in mm)

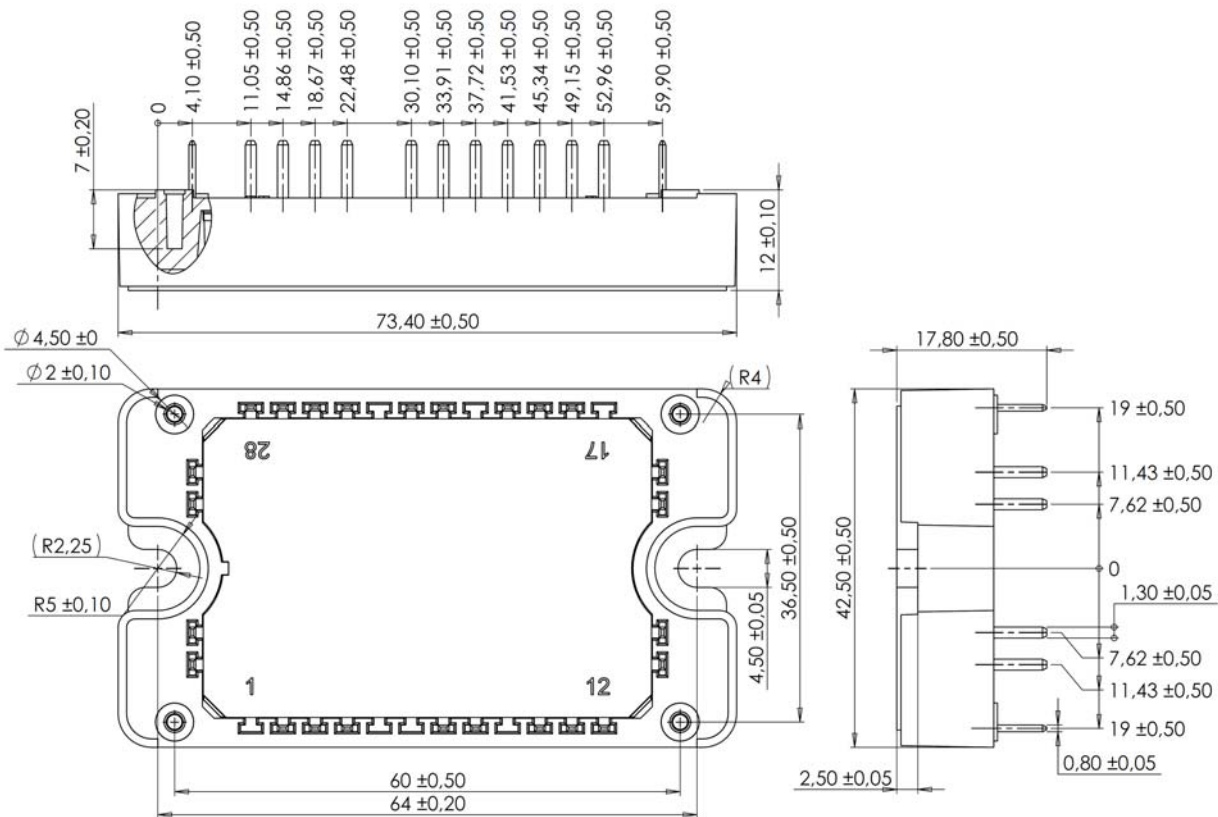

See application note 1906 - Mounting Instructions for SP3F Power Modules on [www.microsemi.com](http://www.microsemi.com)

## Typical Performance Curve

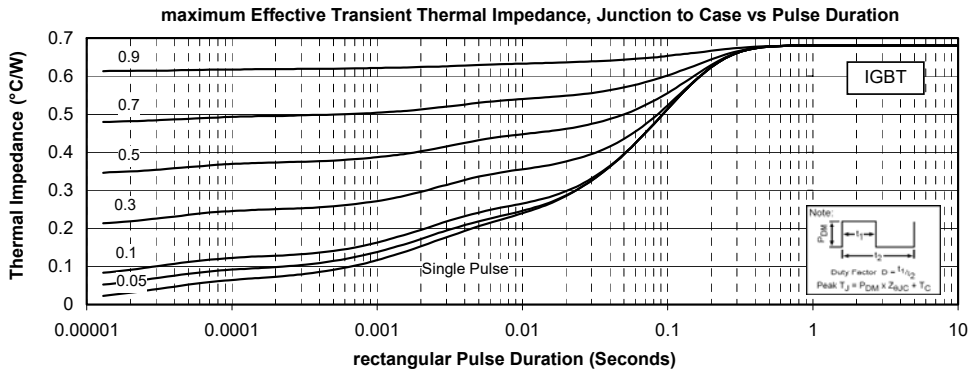
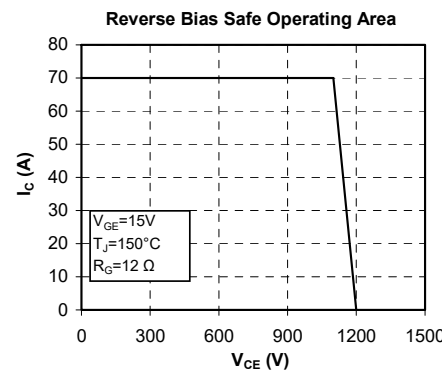
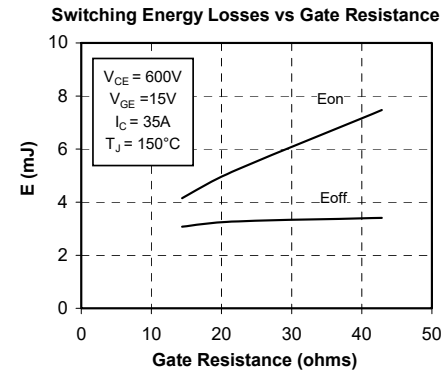
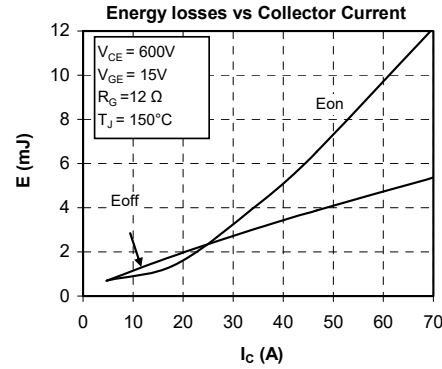
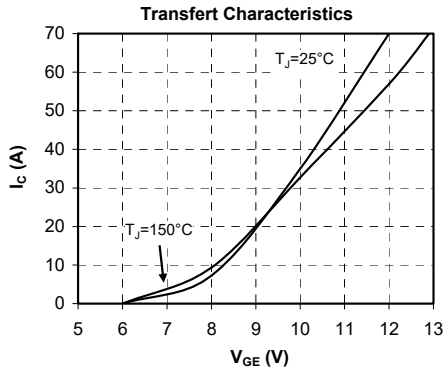
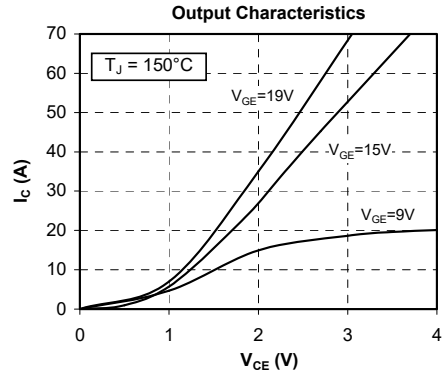
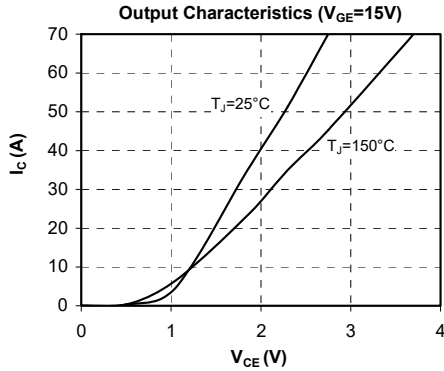

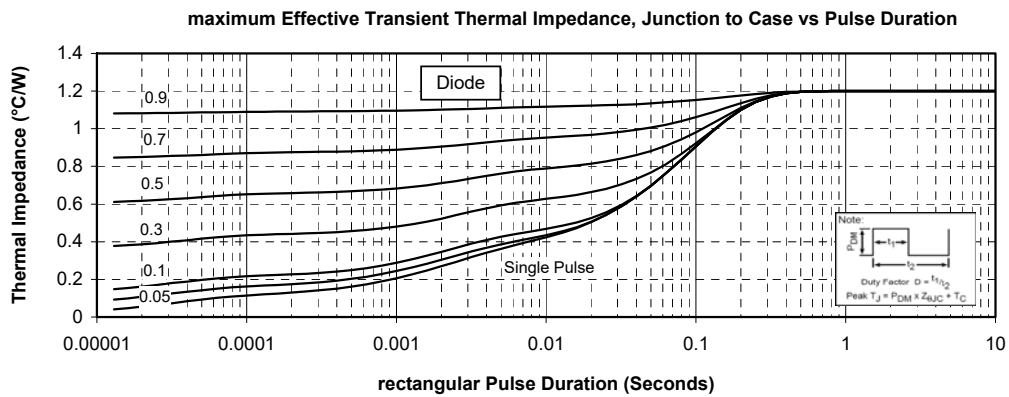
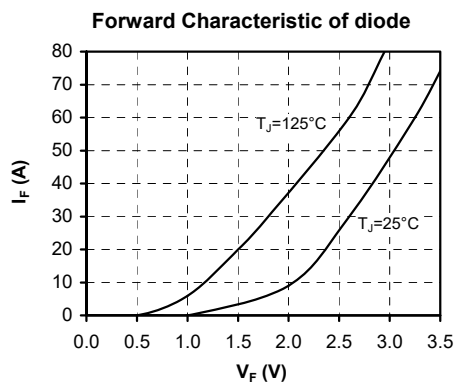
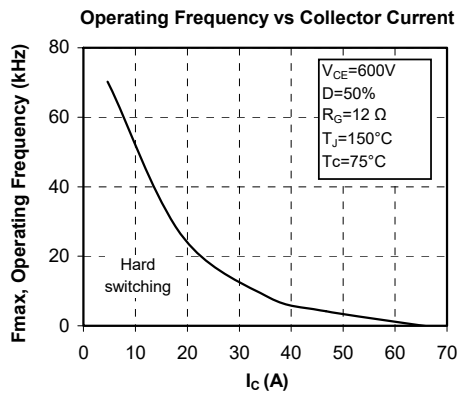

DISCLAIMER

The information contained in the document (unless it is publicly available on the Web without access restrictions) is PROPRIETARY AND CONFIDENTIAL information of Microsemi and cannot be copied, published, uploaded, posted, transmitted, distributed or disclosed or used without the express duly signed written consent of Microsemi. If the recipient of this document has entered into a disclosure agreement with Microsemi, then the terms of such Agreement will also apply. This document and the information contained herein may not be modified, by any person other than authorized personnel of Microsemi. No license under any patent, copyright, trade secret or other intellectual property right is granted to or conferred upon you by disclosure or delivery of the information, either expressly, by implication, inducement, estoppels or otherwise. Any license under such intellectual property rights must be approved by Microsemi in writing signed by an officer of Microsemi.

Microsemi reserves the right to change the configuration, functionality and performance of its products at anytime without any notice. This product has been subject to limited testing and should not be used in conjunction with life-support or other mission-critical equipment or applications. Microsemi assumes no liability whatsoever, and Microsemi disclaims any express or implied warranty, relating to sale and/or use of Microsemi products including liability or warranties relating to fitness for a particular purpose, merchantability, or infringement of any patent, copyright or other intellectual property right. Any performance specifications believed to be reliable but are not verified and customer or user must conduct and complete all performance and other testing of this product as well as any user or customers final application. User or customer shall not rely on any data and performance specifications or parameters provided by Microsemi. It is the customer's and user's responsibility to independently determine suitability of any Microsemi product and to test and verify the same. The information contained herein is provided "AS IS, WHERE IS" and with all faults, and the entire risk associated with such information is entirely with the User. Microsemi specifically disclaims any liability of any kind including for consequential, incidental and punitive damages as well as lost profit. The product is subject to other terms and conditions which can be located on the web at <http://www.microsemi.com/legal/tnc.asp>

Life Support Application

Seller's Products are not designed, intended, or authorized for use as components in systems intended for space, aviation, surgical implant into the body, in other applications intended to support or sustain life, or for any other application in which the failure of the Seller's Product could create a situation where personal injury, death or property damage or loss may occur (collectively "Life Support Applications").

Buyer agrees not to use Products in any Life Support Applications and to the extent it does it shall conduct extensive testing of the Product in such applications and further agrees to indemnify and hold Seller, and its officers, employees, subsidiaries, affiliates, agents, sales representatives and distributors harmless against all claims, costs, damages and expenses, and attorneys' fees and costs arising, directly or indirectly, out of any claims of personal injury, death, damage or otherwise associated with the use of the goods in Life Support Applications, even if such claim includes allegations that Seller was negligent regarding the design or manufacture of the goods.

Buyer must notify Seller in writing before using Seller's Products in Life Support Applications. Seller will study with Buyer alternative solutions to meet Buyer application specification based on Sellers sales conditions applicable for the new proposed specific part.

# Mouser Electronics

Authorized Distributor

Click to View Pricing, Inventory, Delivery & Lifecycle Information:

[Microchip:](#)

[APTGL40X120T3G](#)



Компания «ЭлектроПласт» предлагает заключение долгосрочных отношений при поставках импортных электронных компонентов на взаимовыгодных условиях!

Наши преимущества:

- Оперативные поставки широкого спектра электронных компонентов отечественного и импортного производства напрямую от производителей и с крупнейших мировых складов;
- Поставка более 17-ти миллионов наименований электронных компонентов;
- Поставка сложных, дефицитных, либо снятых с производства позиций;
- Оперативные сроки поставки под заказ (от 5 рабочих дней);
- Экспресс доставка в любую точку России;
- Техническая поддержка проекта, помощь в подборе аналогов, поставка прототипов;
- Система менеджмента качества сертифицирована по Международному стандарту ISO 9001;
- Лицензия ФСБ на осуществление работ с использованием сведений, составляющих государственную тайну;
- Поставка специализированных компонентов (Xilinx, Altera, Analog Devices, Intersil, Interpoint, Microsemi, Aeroflex, Peregrine, Syfer, Eurofarad, Texas Instrument, Miteq, Cobham, E2V, MA-COM, Hittite, Mini-Circuits, General Dynamics и др.);

Помимо этого, одним из направлений компании «ЭлектроПласт» является направление «Источники питания». Мы предлагаем Вам помощь Конструкторского отдела:

- Подбор оптимального решения, техническое обоснование при выборе компонента;
- Подбор аналогов;
- Консультации по применению компонента;
- Поставка образцов и прототипов;
- Техническая поддержка проекта;
- Защита от снятия компонента с производства.



#### Как с нами связаться

**Телефон:** 8 (812) 309 58 32 (многоканальный)

**Факс:** 8 (812) 320-02-42

**Электронная почта:** [org@eplast1.ru](mailto:org@eplast1.ru)

**Адрес:** 198099, г. Санкт-Петербург, ул. Калинина, дом 2, корпус 4, литера А.