







# Toggles

## Product Selection Guide

<b>Toggles</b>						
<b>Series</b>	<b>7000</b>	<b>E</b>	<b>ET</b>	<b>T</b>	<b>GT</b>	<b>9000</b>
<b>Switch Type</b>	Miniature	Miniature	Subminiature	Subminiature	Ultriminiature	Power
<b>Poles/Throws</b>	SPDT, DPDT, 3PDT, 4PDT	SPDT, DPDT, 3PDT	SPST, SPDT, DPDT	SPST, SPDT, DPDT	SPST, SPDT, DPST, DPDT	DPDT
<b>Maximum Current Silver/Gold</b>	5 Amps	7.5 Amps/ 5 Amps	3 Amps/ 2 Amps	3 Amps/ 2 Amps	0.4 VA	10 Amps
<b>Process Sealed</b>		•	•		•	
<b>PCB Mount Options</b>						
Vertical	•	•	•	•	•	•
Right Angle	•	•	•	•	•	
Vertical Right Angle	•	•	•	•	•	•
<b>Surface Mount Options</b>						
Vertical					•	
Right Angle			•		•	
<b>Panel Mount Options</b>						
Rear Mount	•	•		•		•
<b>Termination Options</b>						
PCB Thru-hole	•	•	•	•	•	•
Wire Wrap	•	•	•	•		
Solder Lug	•	•		•		•
Quick Connect	•	•				•
<b>Other Available Options</b>						
Support Brackets	•	•	•	•	•	•
Snap-in Retention	•	•	•			
ESD Protection	•	•	•	•		
Tape & Reel			•		•	
<b>Bushing Options</b>						
10-48				•		
1/4-40	•	•		•		•
15/32	•					•
M6P 0.75 (Metric)	•					
<b>Page No.</b>	F-3	F-17	F-25	F-32	F-38	F-43



# 7000 Series Miniature Toggle Switches

## Features/Benefits

- Multi-pole and multi-position
- Wide variety of actuator and termination options
- Epoxy terminal-seal compatible with bottom wash cleaning
- RoHS complaint models available



Models Available

## Typical Applications

- Telecommunications
- Instrumentation
- Medical equipment

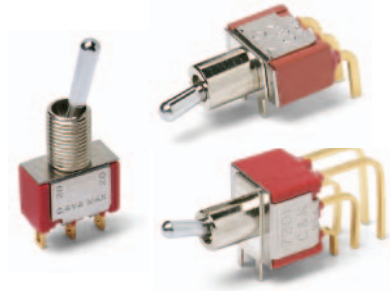

## Specifications

CONTACT RATING: B contact material: 0.4 VA max. @ 20 V AC or DC max. Q contact material: 5 AMPS @ 120 V AC or 28 V DC; 2 AMPS @ 250 V AC. See page G-16 for additional ratings.

ELECTRICAL LIFE: 7X01 and UX1 models: 100,000 make-and-break cycles at full load. All other models: 40,000 cycles.

CONTACT RESISTANCE: Below 10 m Ω typ. initial @ 2-4 V DC, 100 mA, for both silver and gold plated contacts.

INSULATION RESISTANCE: 10<sup>9</sup> Ω min.

DIELECTRIC STRENGTH: 1000 Vrms min. @ sea level.

OPERATING TEMPERATURE: -30°C to 85°C.

SOLDERABILITY: Per MIL-STD-202F method 208D, or EIA RS-186E method 9 (1 hour steam aging).

For materials see page F-4.

**NOTE:** Any models supplied with P, S, R, Q, B or G contact material are RoHS compliant and compatible.

**NOTE:** Specifications listed above are for switches with standard options. For information on specific and custom switches, consult Customer Service Center.

## Build-A-Switch

To order, simply select desired option from each category and place in the appropriate box. Available options are shown and described on pages F-4 thru F-16. For additional options not shown in catalog, consult our Customer Service Center.

<p><b>Switch Function</b></p> <p><b>7101</b> SP On-None-On  <b>7103</b> SP On-Off-On  <b>7105</b> SP Mom.-Off-Mom.  <b>7107</b> SP On-Off-Mom.  <b>7108</b> SP On-None-Mom.  <b>7109</b> SP None-On-Mom.  <b>7201</b> DP On-None-On  <b>7203</b> DP On-Off-On  <b>7205</b> DP Mom.-Off-Mom.  <b>7207</b> DP On-Off-Mom.  <b>7208</b> DP On-None-Mom.  <b>7211</b> DP On-On-On  <b>7213</b> DP On-On-Mom.  <b>7215</b> DP Mom.-On-Mom.  <b>7301</b> 3P On-None-On  <b>7303</b> 3P On-Off-On  <b>7305</b> 3P Mom.-Off-Mom.  <b>7308</b> 3P On-None-Mom.  <b>7401</b> 4P On-None-On  <b>7403</b> 4P On-Off-On  <b>7405</b> 4P Mom.-Off-Mom.  <b>7408</b> 4P On-None-Mom.  <b>7411</b> 4P On-On-On  <b>7413</b> 4P On-On-Mom.  <b>7415</b> 4P Mom.-On-Mom.</p> <p><small>Note: UL/CSA models available, see pages F-4 &amp; F-5.</small></p>	<p><b>Actuator</b></p> <p><b>M</b> .200" high  <b>P3</b> Flatted, anti-rotation, .450" high  <b>S</b> .420" high  <b>T</b> .687" high, 15/32 bushing  <b>K2</b> Locking lever, .704" high  <b>K9</b> Locking lever, .704" high  <b>K12</b> Locking lever, .732" high  <b>K19</b> Locking lever, .732" high  <b>L</b> .840" high  <b>L1</b> .640" high  <b>L1P</b> Anti-rotation, .640" high  <b>L2</b> .550" high  <b>L2P</b> Anti-rotation, .550" high  <b>L3</b> Plastic .940" inch  <b>L40</b> Lever handle without cap  <b>L41</b> .531" high lever handle with cap  <b>L42</b> .838" high lever handle with cap  <b>MP</b> Anti-rotation, .200" high  <b>P1</b> Flatted, anti-rotation, .840" high  <b>P4</b> Flatted, anti-rotation, .250" high  <b>SP</b> Anti-rotation, .420" high  <b>T1</b> .487" high, 15/32 bushing  <b>T1P</b> Anti-rotation, .487" high, 15/32 bushing  <b>T2P</b> Flatted, anti-rotation, .610" high, 15/32 bushing  <b>TP</b> Anti-rotation, .687" high, 15/32 bushing</p>	<p><b>Bushing</b></p> <p><b>D</b> .280 high, keyway  <b>H</b> .296 high, flat  <b>Y</b> .350 high, keyway  <b>NONE</b> No bushing choice required  <b>CW</b> Splashproof  <b>D8</b> .280" high, flat  <b>D9</b> .280" high, keyway  <b>H3</b> .315" high, keyway  <b>H4</b> 8mm high, keyway  <b>Y1</b> .378" high, keyway  <b>Y3</b> 8.9mm high, keyway  <b>Y4</b> .378" high, flat  <b>Y9</b> .350" high, keyway</p> <p><b>Terminations</b></p> <p><b>A</b> Right angle, PC thru-hole  <b>AV2</b> Vert. right angle, PC thru-hole  <b>C</b> PC Thru-hole  <b>V3</b> .460 high, V-bracket  <b>Z</b> Solder lug  <b>A2</b> Right angle, PC thru-hole  <b>A3</b> Right angle, PC thru-hole  <b>A4</b> Right angle, PC thru-hole  <b>AW1</b> Right angle, extended, PC thru-hole  <b>AW4</b> Right angle, extended, PC thru-hole  <b>V2</b> .555" high, V-bracket  <b>V4</b> .630" high, V-bracket  <b>V6</b> .460" high, V-bracket  <b>V7</b> .630" high, V-bracket  <b>V8</b> .953" high, V-bracket  <b>V9</b> 1.150" high, V-bracket  <b>V21</b> .555" high, snap-in V-bracket  <b>V31</b> .460" high, snap-in V-bracket  <b>V41</b> .630" high, snap-in V-bracket  <b>V71</b> .630" high, snap-in V-bracket  <b>V81</b> .953" high, snap-in V-bracket</p>	<p><b>Contact Material</b></p> <p><b>B</b> Gold  <b>P</b> Gold, matte-tin  <b>Q</b> Silver  <b>S</b> Silver, matte-tin  <b>G</b> Gold over silver  <b>R</b> Gold over silver, matte-tin</p> <p><b>Seal</b></p> <p><b>E</b> Epoxy  <b>I</b> Epoxy potted base</p> <p><b>Actuator Color/Finish</b></p> <p><b>NONE</b> Bright chrome  <b>2</b> Black  <b>3</b> Red  <b>S</b> Satin chrome</p> <p><b>KXX Actuator Color/Finish</b></p> <p><b>NONE</b> Natural aluminum  <b>2</b> Black anodized aluminum  <b>3</b> Red anodized aluminum  <b>7</b> Blue anodized aluminum</p> <p><b>Bushing Finish</b></p> <p><b>NONE</b> Nickel on all bushings (except D8, satin chrome)  <b>2</b> Black</p>
--	--	---	--



Dimensions are shown: Inches (mm)  
Specifications and dimensions subject to change

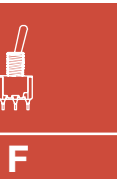

Toggle

# 7000 Series Miniature Toggle Switches

## Materials

CASE: Glass filled nylon 6/6, flame retardant, heat stabilized, or diallyl phthalate (DAP) (UL 94V-0).

ACTUATOR: Brass, chrome plated.

BUSHING: Brass or zinc, nickel plated.

HOUSING: Stainless steel.

SWITCH SUPPORT: Brass or steel, tin plated.

END CONTACTS: B contact material: Copper alloy, with gold plate over nickel plate. Q contact material: Coin silver, silver plated. See page F-15 for additional contact materials.

CENTER CONTACTS & ALL TERMINALS: B contact material: Copper alloy, with gold plate over nickel plate. Q contact material: Copper alloy, silver plated. See above for additional contact materials.







TERMINAL SEAL: Epoxy.

HARDWARE: Nut & Locking Ring: Brass, nickel plated.

Lockwasher: Steel, nickel plated.

**NOTE:** Materials listed above are for switches with standard options. For information on specific and custom switches, consult Customer Service Center.

## SWITCH FUNCTION

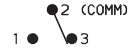
NO. POLES	MODEL NO.	UL/CSA** MODEL NO.	SWITCH FUNCTION			CONNECTED TERMINALS			SCHEMATIC
			POS. 1	POS. 2	POS. 3	POS. 1	POS. 2	POS. 3	
									
SP	7101	U11	ON	NONE	ON	2-3	N/A	2-1	
	7103	U13	ON	OFF	ON	2-3	OPEN	2-1	
	7105	U15	MOM.	OFF	MOM.				
	7107	U17	ON	OFF	MOM.	2-3	N/A	2-1	
	7108	U18	ON	NONE	MOM.				
	7109	U19	NONE	ON	MOM.	N/A	2-3	2-1	

### SPDT

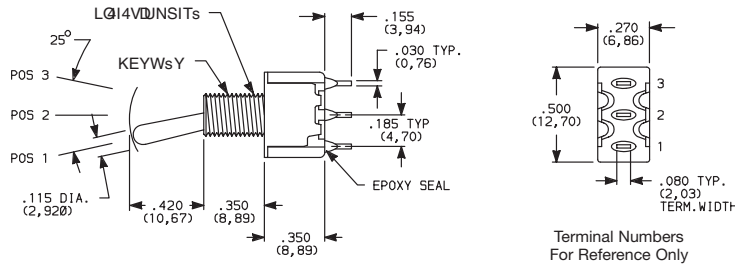

Part number shown: 7101SYZBE

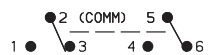

DP	7201	U21	ON	NONE	ON	2-3,5-6	N/A	2-1,5-4	
	7203	U23	ON	OFF	ON	2-3,5-6	OPEN	2-1,5-4	
	7205	U25	MOM.	OFF	MOM.				
	7207	U27	ON	OFF	MOM.	2-3,5-6	N/A	2-1,5-4	
	7208	U28	ON	NONE	MOM.				
	7211*	U211*	ON	ON	ON	2-3,5-6	2-3,5-4	2-1,5-4	
	7213*	U213*	ON	ON	MOM.				
	7215*	U215*	MOM.	ON	MOM.				

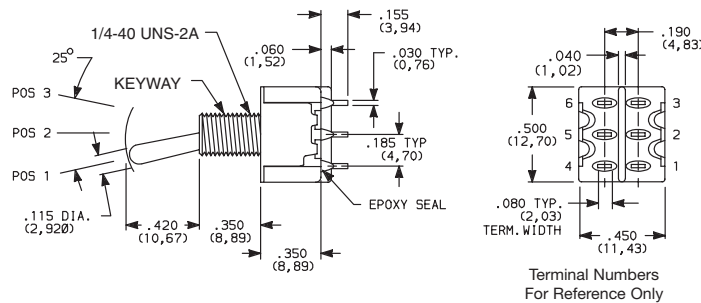
### DPDT



Part number shown: 7201SYZQE

MOM. = Momentary

\*\* U11-U415 model nos.   with all options when ordered with G, R, Q or S contact material.

\* Wiring for 3-way switch, see Section N.



Third Angle  
Projection

Dimensions are shown: Inches (mm)  
Specifications and dimensions subject to change

www.ck-components.com

# 7000 Series Miniature Toggle Switches

## SWITCH FUNCTION

NO. POLES	MODEL NO.	UL/CSA** MODEL NO.	SWITCH FUNCTION			CONNECTED TERMINALS			SCHEMATIC
			POS. 1	POS. 2	POS. 3	POS. 1	POS. 2	POS. 3	
			KEYWAY	KEYWAY	KEYWAY	KEYWAY	KEYWAY	KEYWAY	
3P	<b>7301</b>	<b>U31</b>	ON	NONE	ON	2-3,5-6,8-9	N/A	2-1,5-4,8-7	
	<b>7303</b>	<b>U33</b>	ON	OFF	ON	2-3,5-6,8-9		2-1,5-4,8-7	
	<b>7305</b>	<b>U35</b>	MOM.	OFF	MOM.	2-3,5-6,8-9	OPEN	2-1,5-4,8-7	
	<b>7307</b>	<b>U37</b>	ON	OFF	MOM.	2-3,5-6,8-9		2-1,5-4,8-7	
	<b>7308</b>	<b>U38</b>	ON	NONE	MOM.	2-3,5-6,8-9	N/A	2-1,5-4,8-7	

### 3PDT

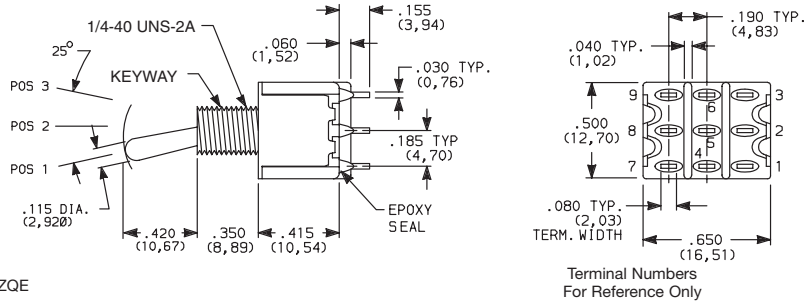

Part number shown: 7301SYZQE

4P	<b>7401</b>	<b>U41</b>	ON	NONE	ON	2-3,5-6,8-9,11-12	N/A	2-1,5-4,8-7,11-10	
	<b>7403</b>	<b>U43</b>	ON	OFF	ON	2-3,5-6,8-9,11-12		2-1,5-4,8-7,11-10	
	<b>7405</b>	<b>U45</b>	MOM.	OFF	MOM.	2-3,5-6,8-9,11-12	OPEN	2-1,5-4,8-7,11-10	
	<b>7408</b>	<b>U48</b>	ON	NONE	MOM.	2-3,5-6,8-9,11-12	N/A	2-1,5-4,8-7,11-10	
	<b>7411*</b>	<b>U411*</b>	ON	ON	ON	2-3,5-6,8-9,11-12		2-1,5-4,8-7,11-10	
	<b>7413*</b>	<b>U413*</b>	ON	ON	MOM.	2-3,5-6,8-9,11-12	2-3,5-4,8-9,11-10	2-1,5-4,8-7,11-10	
	<b>7415*</b>	<b>U415*</b>	MOM.	ON	MOM.	2-3,5-6,8-9,11-12		2-1,5-4,8-7,11-10	

### 4PDT

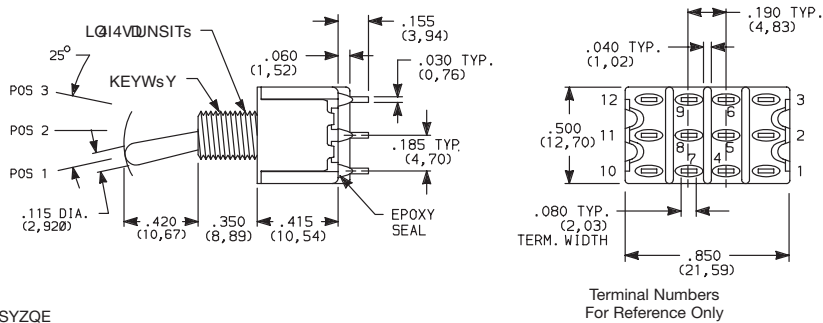

Part number shown: 7401SYZQE

MOM. = Momentary

\* Wiring for 3-way switch, see Section N.

\*\* U11-U415 model nos.



all options when ordered with G, Q, R or S contact material.



Third Angle  
Projection

Dimensions are shown: Inches (mm)  
Specifications and dimensions subject to change



Toggle

# 7000 Series Miniature Toggle Switches

## ACTUATOR

**S** .420" HIGH <sup>1</sup>  
**SP** ANTIROTATION, .420" HIGH <sup>2,3</sup>

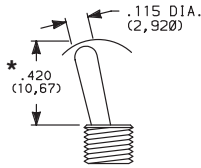

S actuator standard when ordered with C, W-W5, Z & Z3 terminations. Caps are available separately, see page F-16.

**M** .200" HIGH <sup>1</sup>  
**MP** ANTIROTATION, .200" HIGH <sup>2,3</sup>

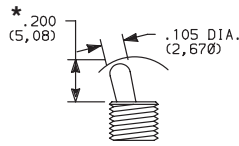

M actuator standard when ordered with all terminations except C, W-W5, Z & Z3. Caps are available separately, see page F-16.

**L, L1, L2** .840", .640", .550" HIGH <sup>1</sup>  
**L1P, L2P** ANTIROTATION, .840", .640", .550" HIGH <sup>2,3</sup>

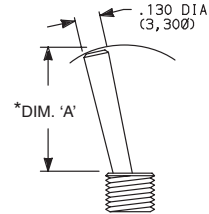

OPTION CODE	DIM 'A'
L	.840 (21,34)
L1, L1P	.640 (16,26)
L2, L2P	.550 (13,97)

Caps are available separately, see page F-16.

**P1** FLATTED WITH ANTIROTATION, .840" HIGH <sup>2,3</sup>

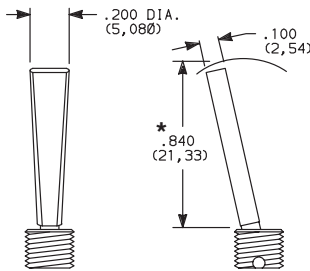

**P3** FLATTED WITH ANTIROTATION, .450" HIGH <sup>2,3</sup>

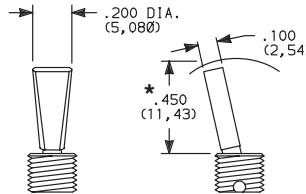

**P4** FLATTED WITH ANTIROTATION, .250" HIGH <sup>2,3</sup>

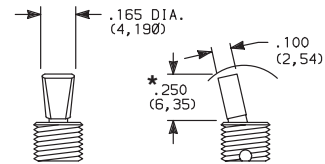

Dress nut part number 709901201 supplied standard with threaded bushing. (Part number 709903201 with metric threaded bushings.)

**T** .687 (17,45) HIGH <sup>1,2</sup>  
**TP** ANTIROTATION, .687 (17,45) HIGH, 15/32 BUSHING <sup>1,2,3</sup>

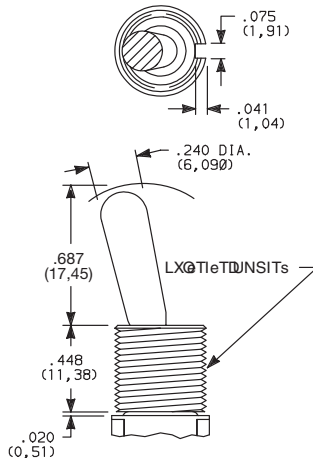

**T1** .487 (12,37) HIGH <sup>1,2</sup>  
**T1P** ANTIROTATION, .487 (12,37) HIGH, 15/32 BUSHING <sup>1,2,3</sup>

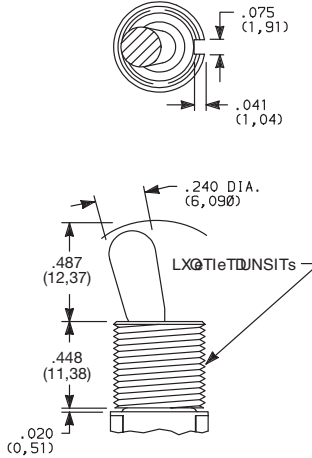

**T2P** FLATTED, ANTIROTATION, .610" HIGH, 15/32 BUSHING <sup>1,2,3</sup>

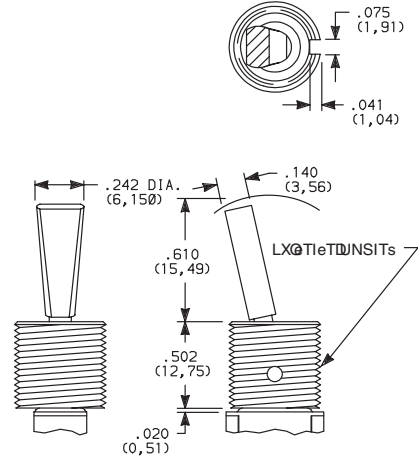

Bushing option code not required unless CW splashproof bushing ordered. TP & T1P actuators not available with CW splashproof bushing. All TXX actuators not available on single pole models with A-A4, AW1-AW4 terminations.

Bushing option code not required. T2P actuator not available with CW splashproof bushing or single pole models with A-A4, AW1-AW4 terminations.

Toggle F

<sup>1</sup> L, L1, L2, M, S & TXX actuators not available with Y1 bushing.  
<sup>2</sup> L1P, L2P, MP, P1, P3, P4, SP & TXX actuators not available with D8 & H4 bushing.  
<sup>3</sup> Antirotation: Provides anti-'push-in' feature on actuator.  
\* Add .070 (1,78) for D, D8 & D9 bushings, subtract .020 (0,51) for H3 bushing.

OPTION CODE	ACTUATOR FINISH
NONE	BRIGHT CHROME-With Nickel Plated Bushing
2	BLACK
S	SATIN CHROME

**NOTE:** Black hardware is supplied when either black actuators or bushings are specified. For additional hardware, see Section N.



Dimensions are shown: Inches (mm)  
Specifications and dimensions subject to change



# 7000 Series Miniature Toggle Switches

## ACTUATOR

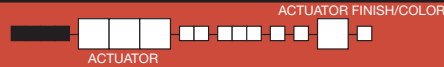

- K2** LOCKING LEVER, .704" HIGH (threaded)  
**K9** LOCKING LEVER, .704" HIGH (unthreaded)

- K12** LOCKING LEVER, .732" HIGH (threaded)  
**K19** LOCKING LEVER, .732" HIGH (unthreaded)

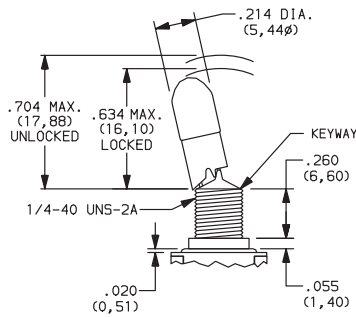

Replaces K, K8

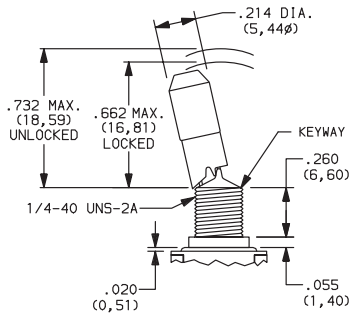

Replaces K1, K18

OPTION CODE	ACTUATOR CAP FINISH
NONE	NATURAL ALUMINUM—With Nickel Plated Bushing
2	BLACK ANODIZED ALUMINUM
3	RED ANODIZED ALUMINUM
7	BLUE ANODIZED ALUMINUM

### Locking Positions



-01 Models  
2 Position lock

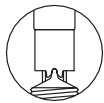

-03 & -11 Models  
3 Position lock



-05, -09 & -15 Models  
1 Position lock



-07 & -13 Models  
2 Position lock



-08 Models  
1 Position lock

**NOTE:** To prevent accidental actuation, toggle must be lifted before being actuated. When released, toggle will lock in place. Overtightening mounting nut may cause actuator to bind.

Locking levers supplied with bushing shown.

Bushing option code not required unless CW splashproof bushing ordered.

- L40** LEVER HANDLE WITHOUT CAP

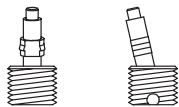

No color choice required

- L41** PLASTIC LEVER HANDLE WITH ANTIROTATION AND CAP, P/N 4810

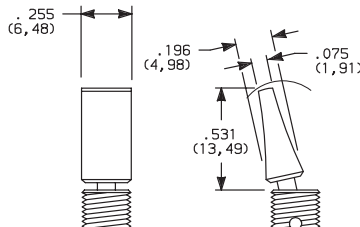

Finish: Matte (L41 & L42).

- L42** PLASTIC LEVER HANDLE WITH ANTIROTATION AND CAP, P/N 4811

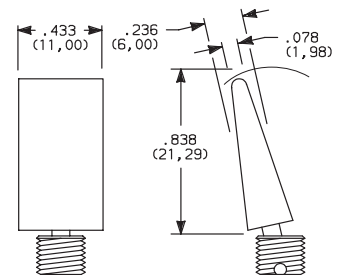

- L3** PLASTIC .940" HIGH

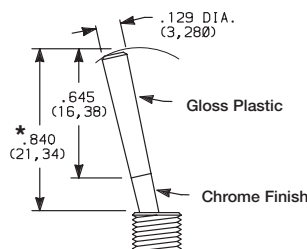

OPTION CODE	PLASTIC ACTUATOR COLORS
NONE	No Actuator Color (L40 option)
2	BLACK
3	RED

\* Add .070 (1,78) for D, D8 & D9 bushings, subtract .020 (0,51) for H3 bushing.

**NOTE:** Lever handle for L41 & L42 actuators supplied, but not installed. For interchangeability, order L40 actuator option and lever handles separately, see page F-16. L4X actuators not available with H4, Y1, Y4 bushings. Antirotation: Provides anti-'push-in' feature on actuator.



Third Angle  
Projection

Dimensions are shown: Inches (mm)  
Specifications and dimensions subject to change



F

Toggle

# 7000 Series Miniature Toggle Switches

## BUSHING

**Y** .350" HIGH, THREADED, KEYWAY  
**Y9** .350" HIGH, UNTHREADED, KEYWAY

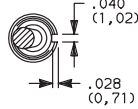

**NONE** NO BUSHING  
No bushing choice required with KXX, TXX actuators. (exception: Specify CW if splashproof bushing desired).

**D** .280" HIGH, THREADED, KEYWAY  
**D8** .280" HIGH, UNTHREADED, FLAT<sup>3</sup>  
**D9** .280" HIGH, UNTHREADED, KEYWAY

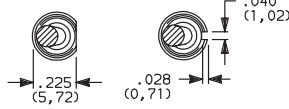

**H** .296" HIGH, FLAT THREADED, HIGH TORQUE<sup>1,2</sup>

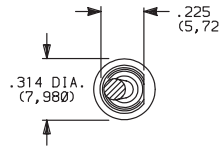

**H3** .315" HIGH, KEYWAY THREADED, HIGH TORQUE<sup>1,2</sup>

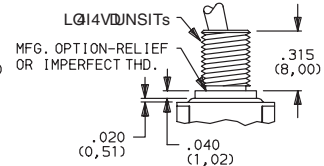
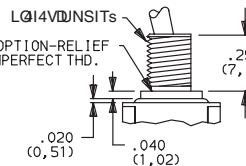
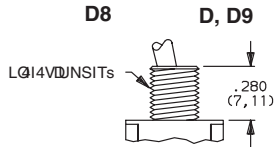
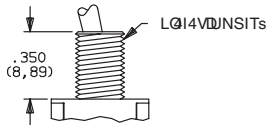
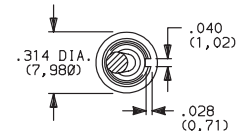

Y bushing standard with C, W-W5, Z or Z3 terminations.

D9 bushing standard with all terminations except C, W-W5, Z or Z3. Add .070 (1,78) to all actuators lengths with D, D8 & D9 bushings.

Subtract .020 (0,51) from all actuator lengths for H3 bushing.

**H4** 8mm HIGH, KEYWAY, THREADED, METRIC HIGH TORQUE<sup>1,2,3</sup>

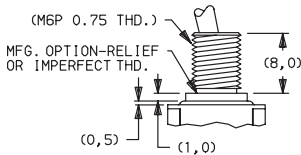
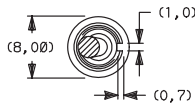

**Y1** .378" HIGH, KEYWAY, THREADED, HIGH TORQUE<sup>1,2,4</sup>

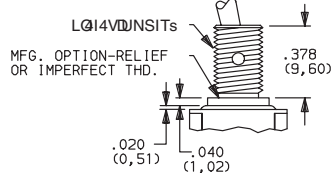
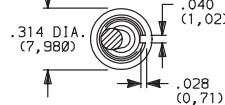

**Y3** 8.9mm HIGH, KEYWAY, THREADED, METRIC

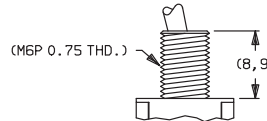
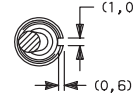

**Y4** .378" HIGH, FLAT, THREADED, HIGH TORQUE<sup>1,2,5</sup>

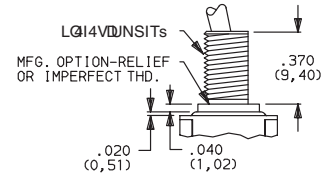
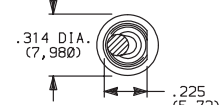

**CW** THREADED, SPLASHPROOF<sup>1,2</sup>

For  $\text{DT} \leq \text{DL}$  Actuators M

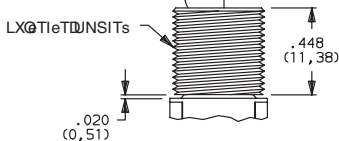
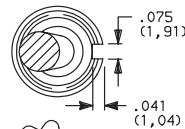

For Actuators Other than  $\text{DT} \leq \text{DL}$

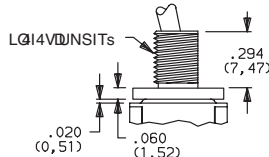
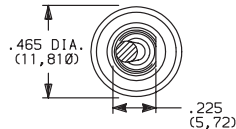

IP67 Degree of protection, totally protected against dust, full-scale voltage protection, temporary immersion. Internal actuator seal standard. External bushing seal available separately from APM Hexseal, part # MFS-60064.

IP67 Degree of protection, totally protected against dust, full-scale voltage protection, temporary immersion. Internal actuator seal and external bushing seal washer standard.

OPTION CODE	BUSHING FINISH
NONE	NICKEL on all bushings except 'D8' satin chrome.
2	BLACK

<sup>1</sup> Will withstand 12 in.-lbs. of torque with no distortion.

<sup>2</sup> CW, H, H3, H4, Y1 & Y4 bushings not available on single pole models with A4 terminations.

<sup>3</sup> D8 & H4 bushings available only with L, L1, L2, M & S actuators.

<sup>4</sup> Y1 bushing available only with LXP, MP, PX & SP actuators.

<sup>5</sup> Y4 bushing not available with L4X actuators.

**NOTE:** Two mounting nuts, locking ring and lockwasher supplied standard with threaded bushings. Black hardware is supplied when either black bushings or actuators are specified. Optional mounting nut and locking ring styles and finishes available, see Section N.

## PANEL MOUNTING

LQ14VNSITs

METRIC

LX14TNSITs

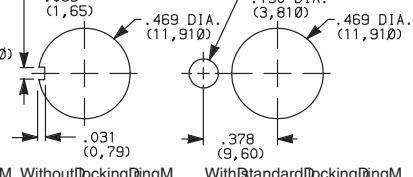
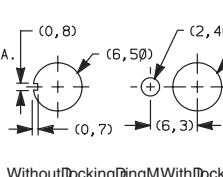
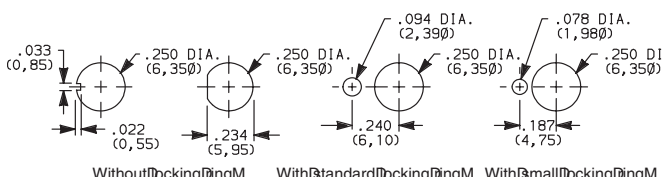

Dimensions are shown: Inches (mm)  
Specifications and dimensions subject to change



# 7000 Series Miniature Toggle Switches

## TERMINATIONS

### Z SOLDER LUG



### SPDT thru 4PDT

Not available with P, R or S contact materials.

### C PC THRU-HOLE

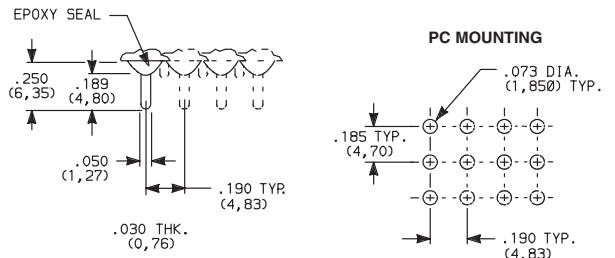

### SPDT thru 4PDT

### Z3 QUICK CONNECT

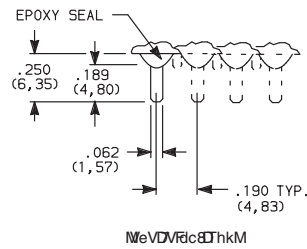

### SPDT thru 4PDT

Not available with P, R or S contact materials.  
Mating quick connector available, order part number 530100000, page F-16.

### W, W1, W3, W4, W5 WIRE WRAP

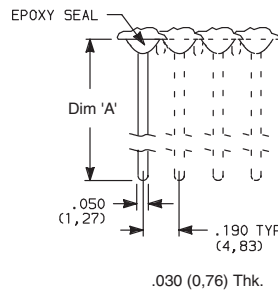

### SPDT thru 4PDT

OPTION CODE	DIM 'A'
<b>W</b>	.750 (19,05)
<b>W1</b>	.964 (24,48)
<b>W3</b>	.425 (10,80)
<b>W4</b>	1.062 (26,97)
<b>W5</b>	1.305 (33,15)

### A RIGHT ANGLE, PC THRU-HOLE

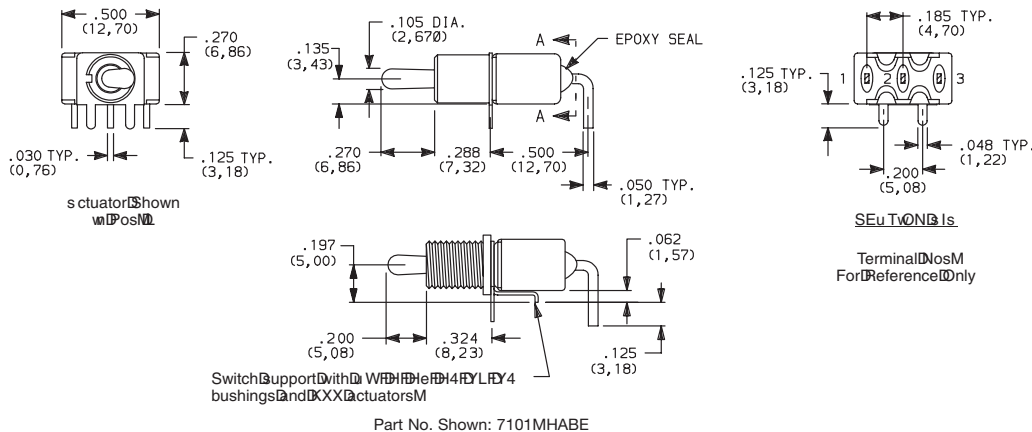

### A3 RIGHT ANGLE, SNAP-IN, PC THRU-HOLE

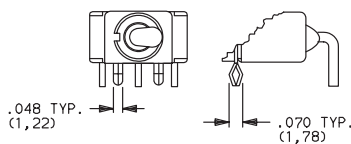

Not available with I seal option.  
Terminal bend radii and lead-in manufacturing option.

### AW1, AW4 RIGHT ANGLE, EXTENDED, PC THRU-HOLE

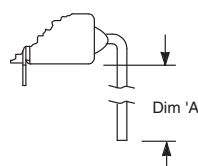

OPTION CODE	DIM 'A'
<b>AW1</b>	.72 (18,3)
<b>AW4</b>	.83 (21,1)

### PC MOUNTING

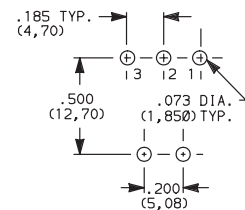

Dimensions are shown: Inches (mm)  
Specifications and dimensions subject to change

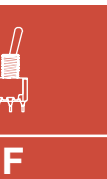



# 7000 Series Miniature Toggle Switches

## TERMINATIONS

### A RIGHT ANGLE, PC THRU-HOLE

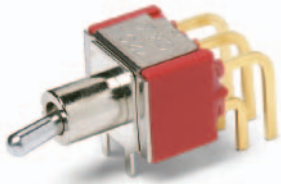

**7201MD9ABE**  
Horizontal Actuation  
**DPDT**

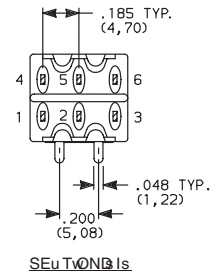
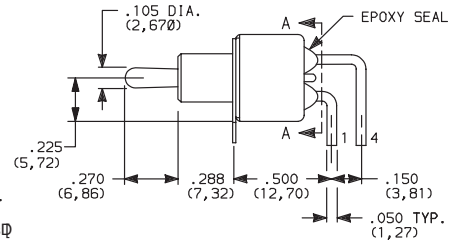
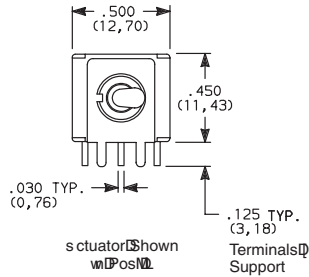

### A3 RIGHT ANGLE, SNAP-IN, PC THRU-HOLE

### AW1, AW4 RIGHT ANGLE, EXTENDED, PC THRU-HOLE

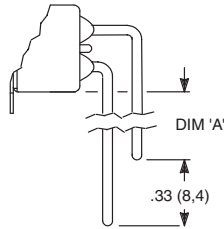
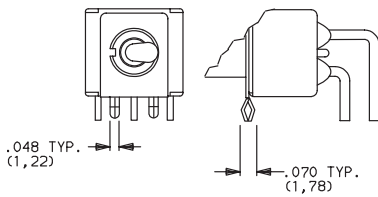

OPTION CODE	DIM 'A'
<b>AW1</b>	.40 (10,2)
<b>AW4</b>	.50 (12,7)

### PC MOUNTING

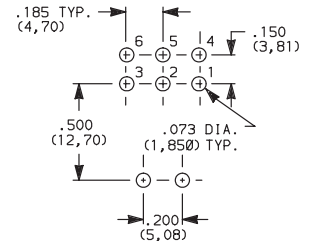

Not available with I seal option.  
Terminal bend radii and lead-in manufacturing option.

### A RIGHT ANGLE, PC THRU-HOLE



**7301MD9ABE**  
Horizontal Actuation  
**3PDT**

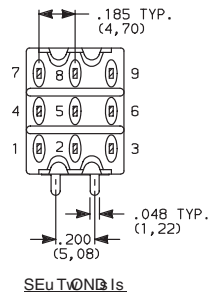
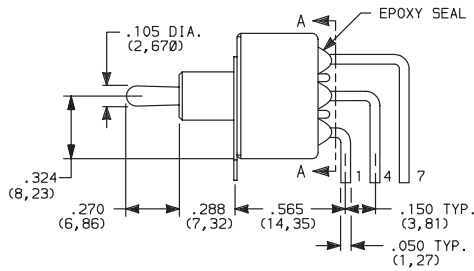
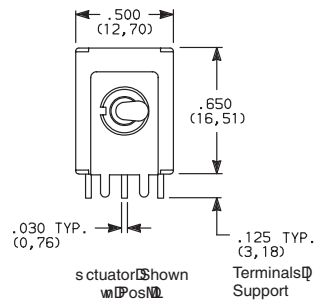

### AW4 RIGHT ANGLE, EXTENDED, PC THRU-HOLE

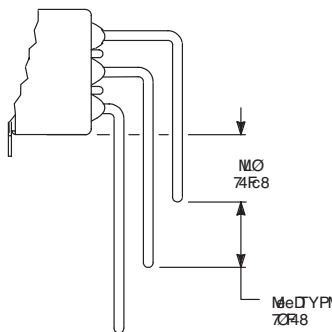

### PC MOUNTING

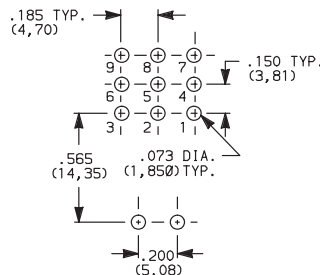

Not available with I seal option.  
Terminal bend radii and lead-in manufacturing option.



**F**

**Toggle**



Dimensions are shown: Inches (mm)  
Specifications and dimensions subject to change

# 7000 Series Miniature Toggle Switches

## TERMINATIONS

**A2** RIGHT ANGLE, PC THRU-HOLE,  
.156" PITCH

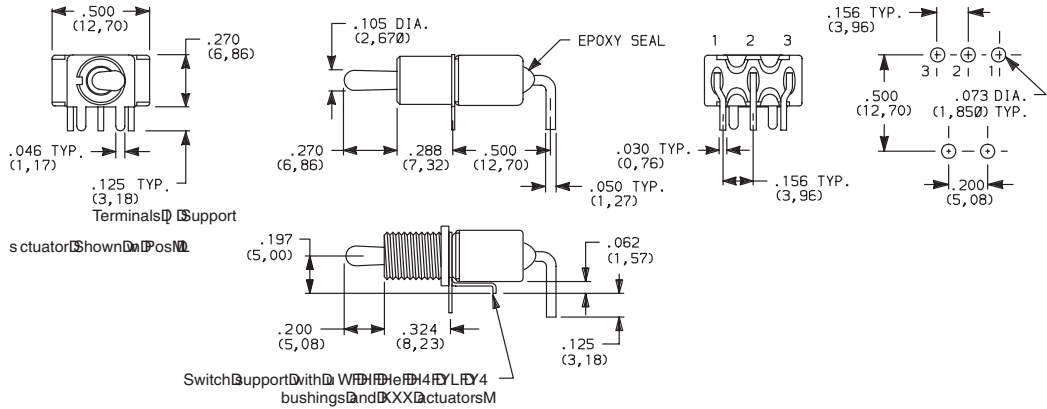

**7101MHA2BE**  
Horizontal Actuation  
**SPDT**

Not available with TXX actuators and I seal.  
Terminal bend radii and lead-in manufacturing option.  
Part No. Shown: 7101MHA2BE

**A4** RIGHT ANGLE, PC THRU-HOLE,  
.156" PITCH

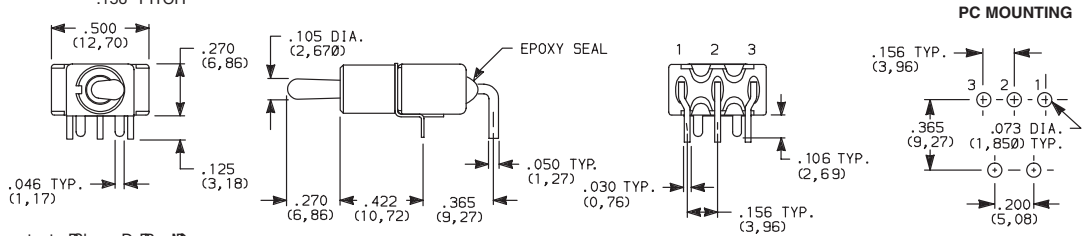

**7101MD9A4BE**  
Horizontal Actuation  
**SPDT**

Not available with KXX & TXX actuators, CW, H, H3, H4, Y1 & Y4 bushings, and I seal. Terminal bend radii and lead-in manufacturing option.

**NOTE:** The A4 option is available with any contact material and can be UL recognized and CSA certified. The PC pattern must clear switch support legs.

**AV2** VERTICAL RIGHT ANGLE, PC THRU-HOLE,  
.150" PITCH

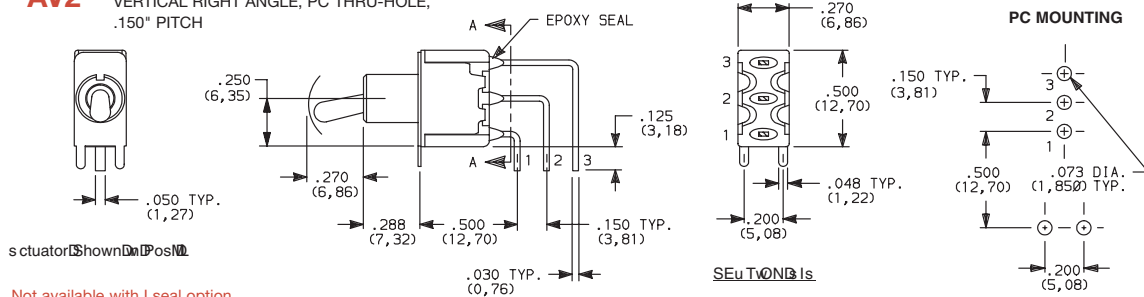

**7101MD9AV2BE**  
Horizontal Actuation  
**SPDT**

Not available with I seal option.  
Terminal bend radii and lead-in manufacturing option.

**AV2** VERTICAL RIGHT ANGLE, PC THRU-HOLE,  
.150" PITCH

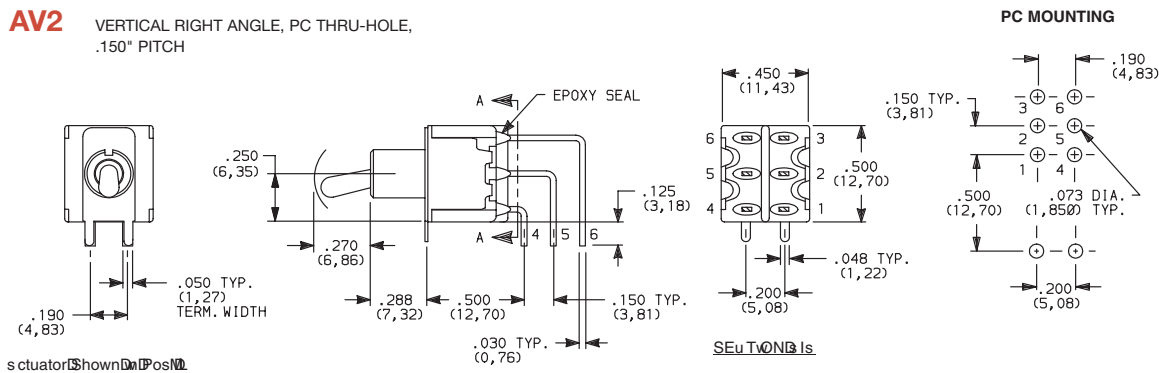

**7201MD9AV2BE**  
Vertical Actuation  
**DPDT**

Not available with I seal option.  
Terminal bend radii and lead-in manufacturing option.



Dimensions are shown: Inches (mm)  
Specifications and dimensions subject to change



# 7000 Series Miniature Toggle Switches

## TERMINATIONS

**AV2** VERTICAL RIGHT ANGLE, PC THRU-HOLE,  
.150" PITCH



**7301MD9AV2BE**  
Vertical Actuation  
**3PDT**

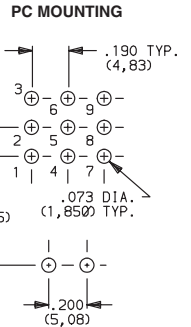
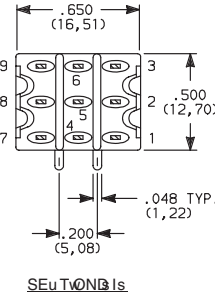
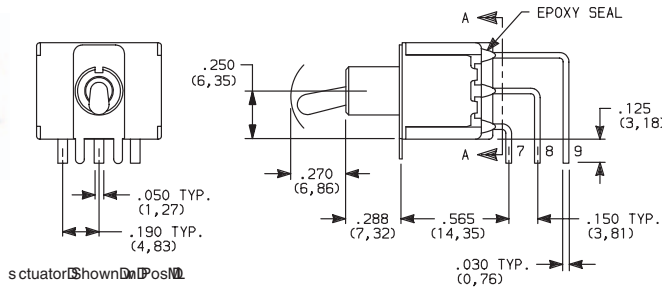

Not available with I seal option.  
Terminal bend radii and lead-in manufacturing option.

**AV2** VERTICAL RIGHT ANGLE, PC THRU-HOLE,  
.150" PITCH



**7401MD9AV2BE**  
Vertical Actuation  
**4PDT**

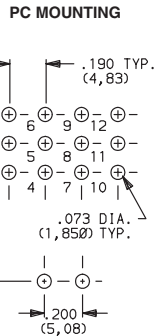
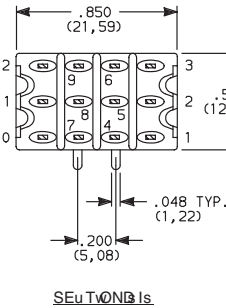
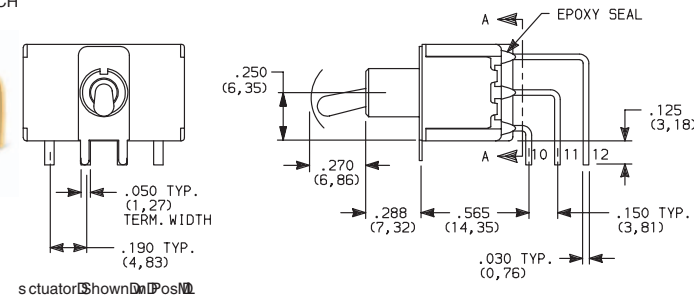

Not available with I seal option.  
Terminal bend radii and lead-in manufacturing option.

**V2, V6, V7, V8** VERTICAL MOUNT, V-BRACKET

**V21, V71, V81** VERTICAL MOUNT, V-BRACKET, SNAP-IN



**7101MD9\_BE**  
**SPDT**

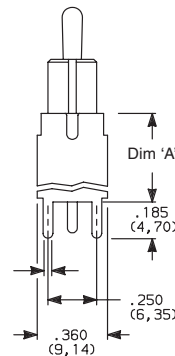
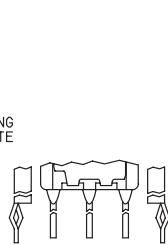
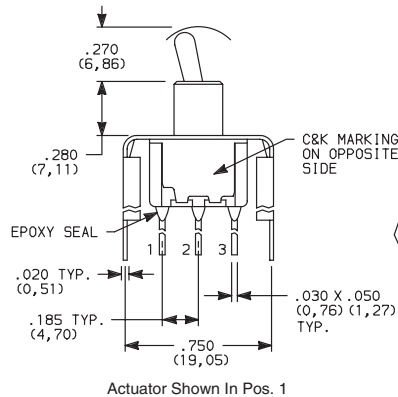

PC MOUNTING

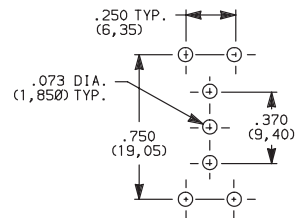

OPTION CODE	DIM 'A'
<b>V2, V21</b>	.555 (14,10)
<b>V6</b>	.460 (11,68)
<b>V7, V71</b>	.630 (16,00)
<b>V8, V81</b>	.953 (24,21)

Not available with I seal option.



F

Toggle



Dimensions are shown: Inches (mm)  
Specifications and dimensions subject to change

# 7000 Series Miniature Toggle Switches

## TERMINATIONS



**V2, V6, V7, V8** VERTICAL MOUNT, V-BRACKET

**V21, V61, V71, V81** VERTICAL MOUNT, V-BRACKET, SNAP-IN

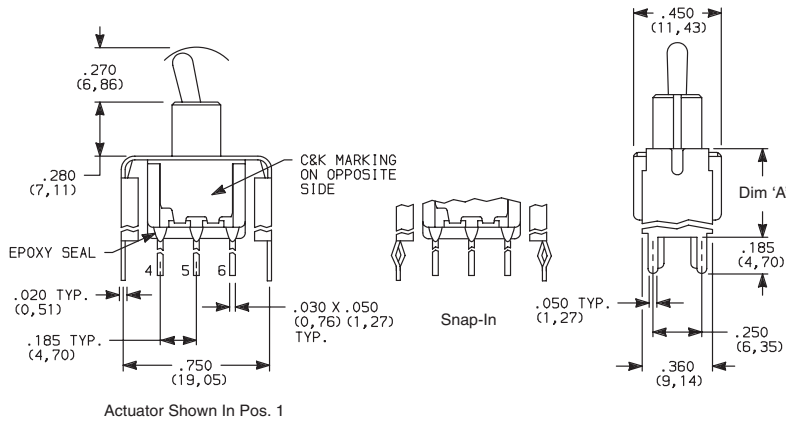

PC MOUNTING

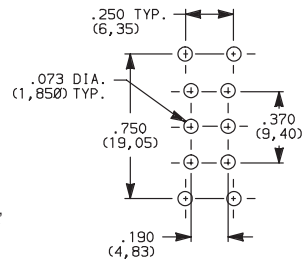

7201MD9\_BE  
DPDT

OPTION CODE	DIM 'A'
V2, V21	.555 (14,10)
V6, V61	.460 (11,68)
V7, V71	.630 (16,00)
V8, V81	.953 (24,21)

**V2, V7, V8** VERTICAL MOUNT, V-BRACKET

**V21, V71, V81** VERTICAL MOUNT, V-BRACKET, SNAP-IN

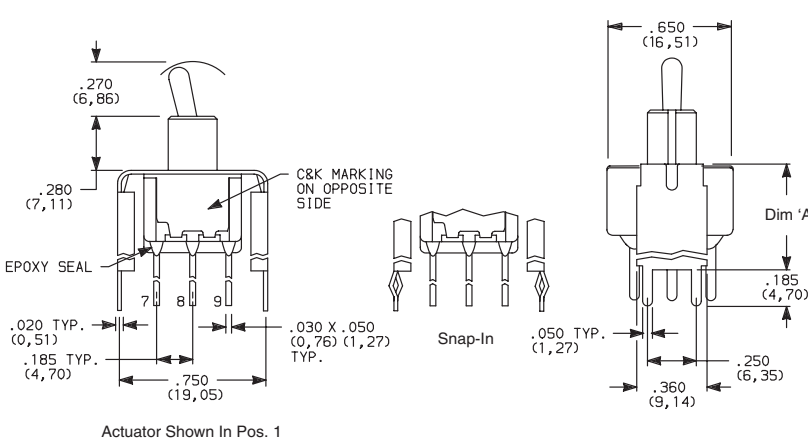

PC MOUNTING

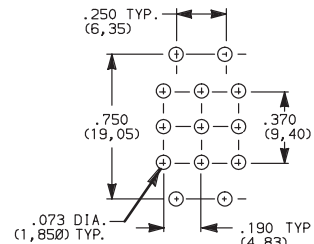

7301MD9\_BE  
3PDT

OPTION CODE	DIM 'A'
V2, V21	.555 (14,10)
V7, V71	.630 (16,00)
V8, V81	.953 (24,21)

**V2, V7, V8** VERTICAL MOUNT, V-BRACKET

**V21, V71, V81** VERTICAL MOUNT, V-BRACKET, SNAP-IN

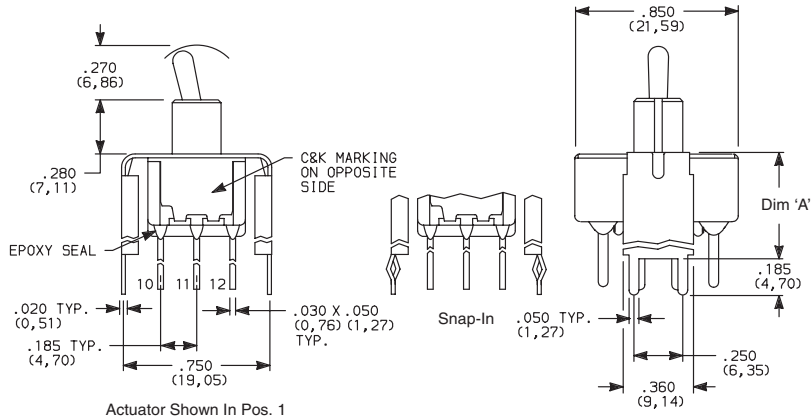

PC MOUNTING

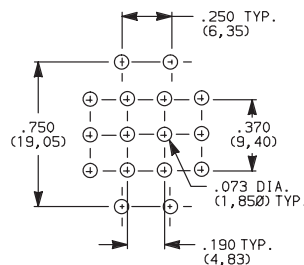

7401MD9\_BE  
4PDT

OPTION CODE	DIM 'A'
V2, V21	.555 (14,10)
V7, V71	.630 (16,00)
V8, V81	.953 (24,21)



Third Angle  
Projection

Dimensions are shown: Inches (mm)  
Specifications and dimensions subject to change



F

Toggle

# 7000 Series Miniature Toggle Switches

## TERMINATIONS

**V3, V4, V9** VERTICAL MOUNT, V-BRACKET

**V31, V41** VERTICAL MOUNT, V-BRACKET, SNAP-IN

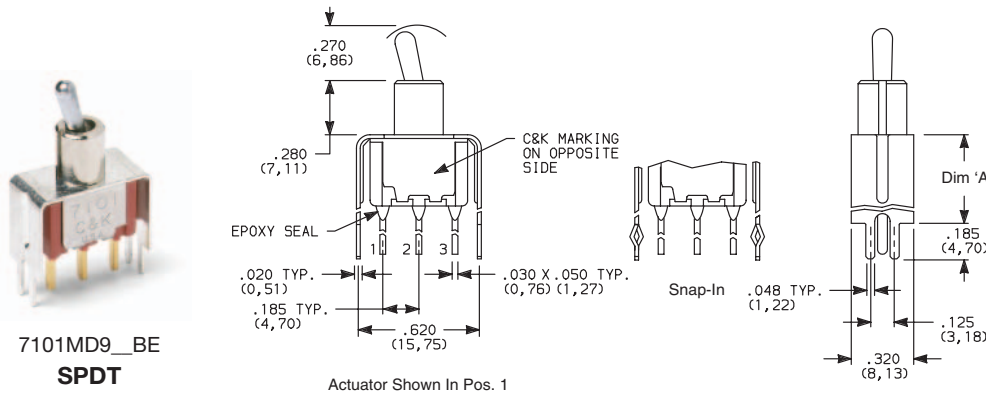

PC MOUNTING

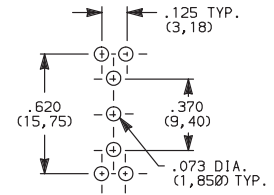

OPTION CODE	DIM 'A'
V3, V31	.460 (11,68)
V4, V41	.630 (16,00)
V9	1.150 (29,21)

Not available with I seal option.

**V3, V4, V9** VERTICAL MOUNT, V-BRACKET

**V31, V41** VERTICAL MOUNT, V-BRACKET, SNAP-IN

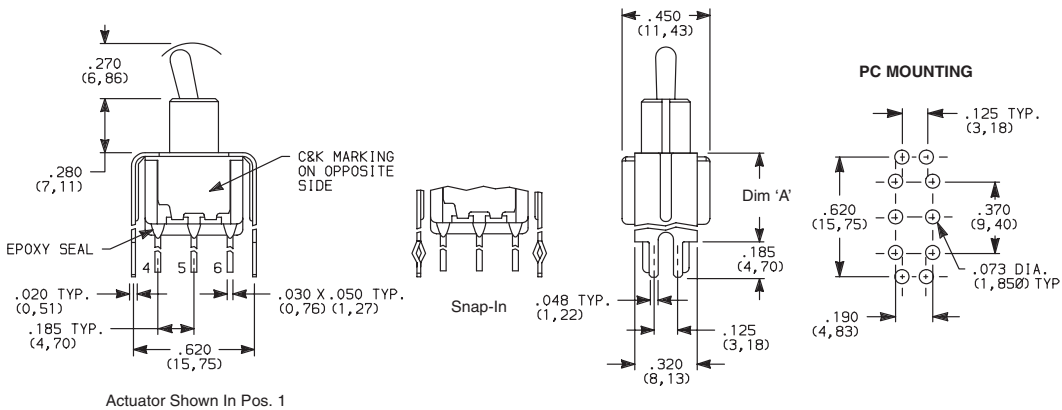

OPTION CODE	DIM 'A'
V3, V31	.460 (11,68)
V4, V41	.630 (16,00)
V9	1.150 (29,21)

Not available with I seal option.

**V4, V9** VERTICAL MOUNT, V-BRACKET

**V41** VERTICAL MOUNT, V-BRACKET, SNAP-IN

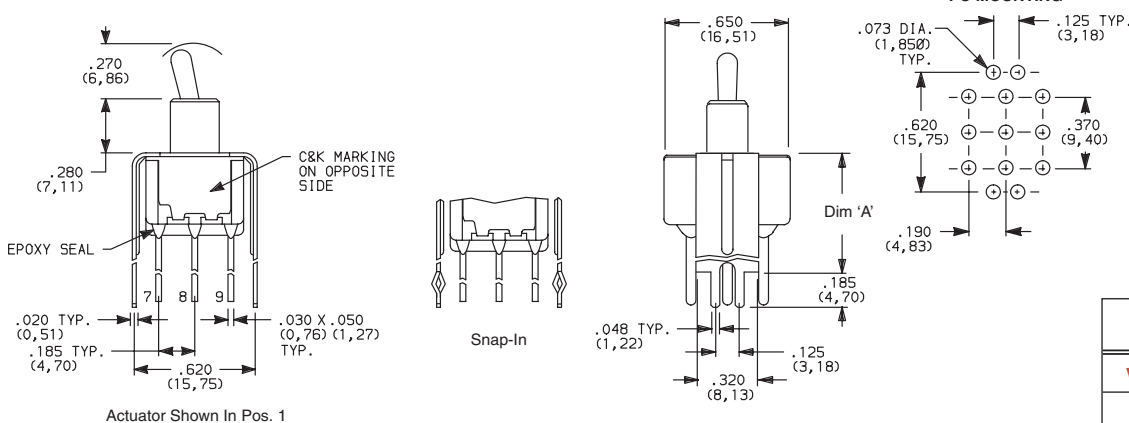

OPTION CODE	DIM 'A'
V4, V41	.630 (16,00)
V9	1.150 (29,21)

Not available with I seal option.



Dimensions are shown: Inches (mm)  
Specifications and dimensions subject to change

www.ck-components.com



F

Toggle



# 7000 Series Miniature Toggle Switches

## TERMINATIONS

**V4, V9** VERTICAL MOUNT, V-BRACKET

**V41** VERTICAL MOUNT, V-BRACKET, SNAP-IN

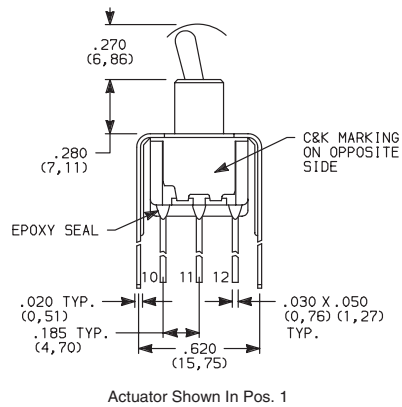

Actuator Shown In Pos. 1

Not available with I seal option.

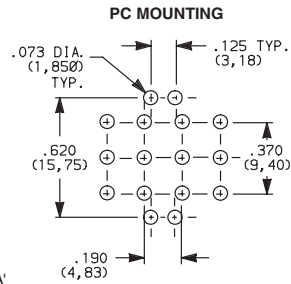
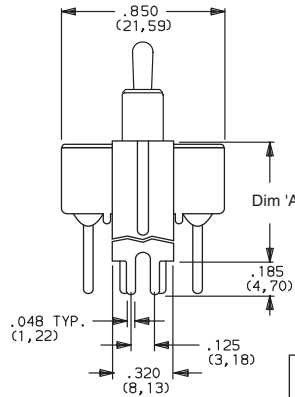
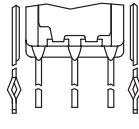

7401MD9\_BE  
4PDT

OPTION CODE	DIM 'A'
<b>V4, V41</b>	.630 (16,00)
<b>V9</b>	1.150 (29,21)

## CONTACT MATERIAL

OPTION CODE	CONTACT MATERIAL	TERMINAL PLATING	RATINGS	
<b>B</b>	GOLD <sup>1</sup>	GOLD <sup>1</sup>	LOW LEVEL/ DRY CIRCUIT	0.4 VA MAX. @ 20 V AC OR DC MAX.
<b>P</b>		MATTE-TIN <sup>6</sup>		
<b>Q</b>	SILVER <sup>4,5</sup>	SILVER <sup>5</sup>	POWER	5 AMPS @ 120 V AC OR 28 V DC; 2 AMPS @ 250 V AC.
<b>S</b>		MATTE-TIN <sup>6</sup>		
<b>G</b>	GOLD OVER SILVER <sup>2,3</sup>	GOLD <sup>3</sup>	LOW LEVEL/DRY CIRCUIT OR POWER	0.4 VA MAX @ 20 V AC OR DC MAX. OR 5 AMPS @ 120 V AC OR 28 V DC; 2 AMPS @ 250 V AC.
<b>R</b>		MATTE-TIN <sup>6</sup>		

\* Note: See Technical Data section of this catalog for RoHS compliant and compatible definitions and specifications.

<sup>1</sup> CONTACTS & TERMINALS: Copper alloy, with gold plate over nickel plate.

<sup>2</sup> END CONTACTS: Coin silver, with gold plate over nickel plate.

<sup>3</sup> CENTER CONTACTS & ALL TERMINALS: Copper alloy, with gold plate over nickel plate.

<sup>4</sup> END CONTACTS: Coin silver, silver plated.

<sup>5</sup> CENTER CONTACT & ALL TERMINALS: Copper alloy, silver plated.

<sup>6</sup> TERMINALS: Copper alloy, with matte tin alloy nickel plate.

**NOTE:** Any models supplied with P, S, R, Q, B or G contact material are RoHS compliant.

U11-U415 model numbers with all options when ordered with G, S, R, or Q contact material.

B contact material standard with all terminations except C, Z & Z3.

Q contact material standard with C, Z & Z3 terminations.

P, S & R contact materials not available with Z & Z3 terminations.



Third Angle  
Projection

Dimensions are shown: Inches (mm)  
Specifications and dimensions subject to change



F

Toggle

# 7000 Series Miniature Toggle Switches

## SEAL

### E EPOXY SEAL

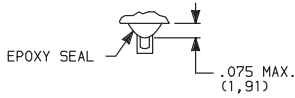

Compatible with "bottom-wash" PC board cleaning methods.

### I EPOXY POTTED BASE

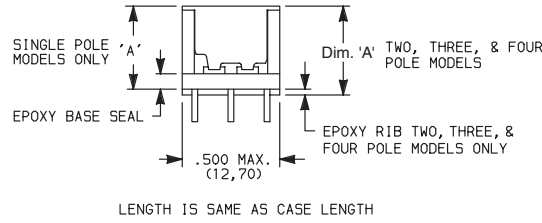

NO. POLES	DIM 'A'
SP	.410 (10,41)
DP	.440 (11,18)
3P	.505 (12,83)
4P	.505 (12,83)

Available with C, W-W5, Z & Z3 terminations only.

## AVAILABLE HARDWARE

### Cap

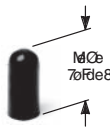

#### PART NO.

896801000 WHITE  
896802000 BLACK  
896803000 RED

Material: Polyethylene  
Finish: Matte

### Cap

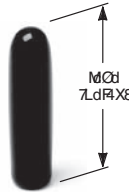

#### PART NO.

763701000 WHITE  
763702000 BLACK  
763703000 RED

Material: Vinyl  
Finish: Matte

### Cap



#### PART NO.

706201000 WHITE  
706202000 BLACK  
706203000 RED

Material: Vinyl  
Finish: Matte

### L41 Lever handle



#### PART NO.

481001000 WHITE  
481002263 BLACK  
481003000 RED

Material: Nylon  
Finish: Matte

### L42 Lever handle

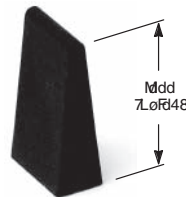

#### PART NO.

481101000 WHITE  
481102263 BLACK  
481103000 RED

Material: Nylon  
Finish: Matte

### Fits Z3 Termination female connector



#### PART NO. 530100000

Available in loose pieces.

**NOTE:** Additional nuts, locking rings and lockwashers available separately, see Section N.

Other colors available, consult Customer Service Center.

### 759D02000 Sealing Boot

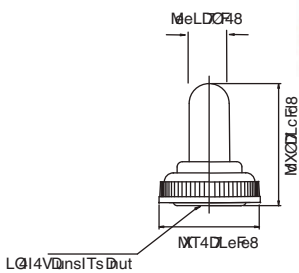

NOTE: For use with S actuator style when combined with D, H, H3, Y, and Y4 bushings

### 703D02000 Sealing Boot

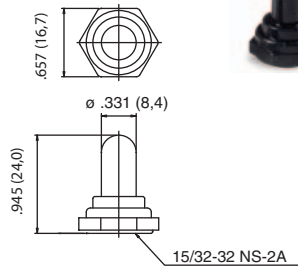

NOTE: For use with T and TP style actuators. **Can not be used for Switch Functions: 7103, 7203, 7303, 7403, 7107, 7207, 7307, 7407.**

### 704D02000 Sealing Boot

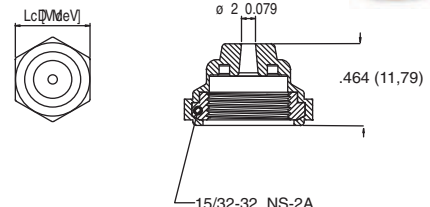

NOTE: For use with T, TP and T2P style actuators. Can not be used for Switch Functions: 7103, 7203, 7303, 7403, 7107, 7207, 7307, and 7407.



Dimensions are shown: Inches (mm)  
Specifications and dimensions subject to change



# E Series Sealed Miniature Toggle Switches

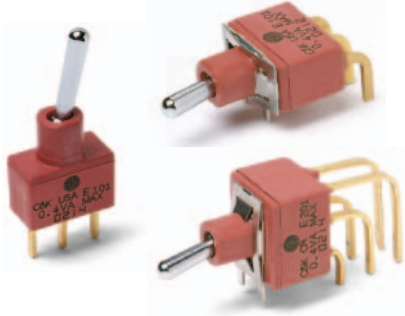

## Features/Benefits

- Sealed against solder and cleaning process contaminants
- UL 94V-0 Nylon case and bushing
- Multi-positions
- ESD protection available
- RoHS compliant models available

## Typical Applications

- Telecommunications
- Instrumentation
- Medical equipment



## Specifications

**CONTACT RATING:** B contact material: 0.4 VA max. @ 20 V AC or DC max. Q contact material: E1XX & E2XX MODELS: 7.5 AMPS @ 125 V AC or 28 V DC; 3 AMPS @ 250 V AC. E3XX MODELS: 5 AMPS @ 125 V AC or 28 V DC; 2 AMPS @ 250 V AC. See page F-25 for additional ratings.

**ELECTRICAL LIFE:** E1XX and E2XX models: 40,000 make-and-break cycles at full load. E3XX models: 30,000 cycles.

**CONTACT RESISTANCE:** Below 10 mΩ typ. initial @ 2-4 V DC, 100 mA, for both silver and gold plated contacts.

**INSULATION RESISTANCE:** 10<sup>9</sup> Ω min.

**ELECTROSTATIC DISCHARGE (ESD) OPTION:** F1 conductive bushing only. Dissipates up to 20,000 V DC from actuator to ground.

**DIELECTRIC STRENGTH:** 1000 Vrms min. @ sea level.

**OPERATING TEMPERATURE:** -30°C to 85°C.

**SOLDERABILITY:** Per MIL-STD-202F method 208D, or EIA RS-186E method 9 (1 hour steam aging).

**DEGREE OF PROTECTION:** IP57; Protection against harmful dust deposit, full-scale voltage protection, temporary immersion.

## Materials

**CASE & BUSHING:** Glass filled nylon 6/6, flame retardant, heat stabilized (UL 94V-0). F1 conductive bushing option is impregnated with carbon fibers.

**ACTUATOR:** Brass, chrome plated with internal o-ring seal standard.

**SWITCH SUPPORT:** Brass or steel, matte-tin plated.

**SWITCH SUPPORT RETAINER:** Stainless steel.

**CONTACTS & TERMINALS:** B contact material: Copper alloy, with gold plate over nickel plate. Q contact material: Copper alloy, silver plated. See page F-29 for additional contact materials.

**TERMINAL SEAL:** Epoxy.

**HARDWARE:** Nut & Locking ring: Brass, nickel plated.  
Lockwasher: Steel, nickel plated.

**NOTE:** Any models supplied with P, S, R, Q, B or G contact material are RoHS compliant and compatible.

**NOTE:** Specifications and materials listed above are for switches with standard options. For information on specific and custom switches, consult Customer Service Center.

## Build-A-Switch

To order, simply select desired option from each category and place in the appropriate box. Available options are shown and described on pages F-18 thru F-24. For additional options not shown in catalog, consult our Customer Service Center. All models are process sealed to withstand machine soldering temperatures and pressure wash cleaning methods.

<p><b>Switch Function</b></p> <p><b>E101</b> SP, On-None-On  <b>E103</b> SP, On-Off-On  <b>E105</b> SP, Mom.-Off-Mom.  <b>E107</b> SP, On-Off-Mom.  <b>E108</b> SP, On-None-Mom.  <b>E201</b> DP, On-None-On  <b>E203</b> DP, On-Off-On  <b>E205</b> DP, Mom.-Off-Mom.  <b>E207</b> DP, On-Off-Mom.  <b>E208</b> DP, On-None-Mom.  <b>E211</b> DP, On-On-On  <b>E213</b> DP, On-On-Mom.  <b>E215</b> DP, Mom.-On-Mom.  <b>E301</b> 3P, On-None-On</p>	<p><b>Actuator</b></p> <p><b>M</b> .300" high  <b>S</b> .500" high  <b>L3</b> Plastic, .940" high</p> <p><b>Bushing</b></p> <p><b>D1</b> .250" high  <b>F1</b> Conductive, .250" high*  <b>D9</b> .280" high  <b>Y</b> Threaded, .350" high</p>	<p><b>Terminations</b></p> <p><b>A</b> Right angle, PC thru-hole  <b>AV2</b> Vertical right angle, PC thru-hole  <b>C</b> PC Thru-hole  <b>V3</b> .460" high, V-bracket  <b>Z</b> Solder lug  <b>A3</b> Right angle, PC thru-hole  <b>AV3</b> Vertical right angle, PC thru-hole  <b>V6</b> .460" high, V-bracket  <b>V9</b> 1.150" high, V-bracket  <b>V31</b> .460" high, snap-in V-bracket  <b>V61</b> .460" high, snap-in V-bracket  <b>W</b> .750" long, wire wrap  <b>Z3</b> Quick connect</p>	<p><b>Contact Material</b></p> <p><b>B</b> Gold  <b>P</b> Gold, matte-tin  <b>Q</b> Silver  <b>S</b> Silver, matte-tin  <b>G</b> Gold over silver  <b>R</b> Gold over silver, matte-tin</p> <p><b>Seal</b></p> <p><b>E</b> Epoxy</p>
---	---	--	--

\* F1 available with SP and DP versions only, please see page F-19



Dimensions are shown: Inches (mm)  
Specifications and dimensions subject to change



# E Series Sealed Miniature Toggle Switches

## SWITCH FUNCTION

NO. POLES	MODEL NO.	SWITCH FUNCTION			CONNECTED TERMINALS			SCHEMATIC
		POS. 1	POS. 2	POS. 3	POS. 1	POS. 2	POS. 3	
SP	<b>E101</b>	ON	NONE	ON	2-3	N/A	2-1	
	<b>E103</b>	ON	OFF	ON	2-3	OPEN	2-1	
	<b>E105</b>	MOM.	OFF	MOM.				
	<b>E107</b>	ON	OFF	MOM.				
	<b>E108</b>	ON	NONE	MOM.				

### SPDT

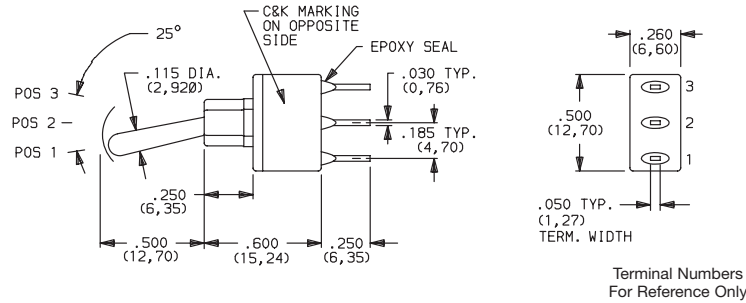

Part number shown: E101SD1CBE

DP	<b>E201</b>	ON	NONE	ON	2-3,5-6	N/A	2-1,5-4	
	<b>E203</b>	ON	OFF	ON	2-3,5-6	OPEN	2-1,5-4	
	<b>E205</b>	MOM.	OFF	MOM.				
	<b>E207</b>	ON	OFF	MOM.				
	<b>E208</b>	ON	NONE	MOM.				
	<b>E211**</b>	ON	ON	ON				
	<b>E213**</b>	ON	ON	MOM.				
<b>E215**</b>	MOM.	ON	MOM.	2-3,5-6	2-3,5-4	2-1,5-4		

### DPDT

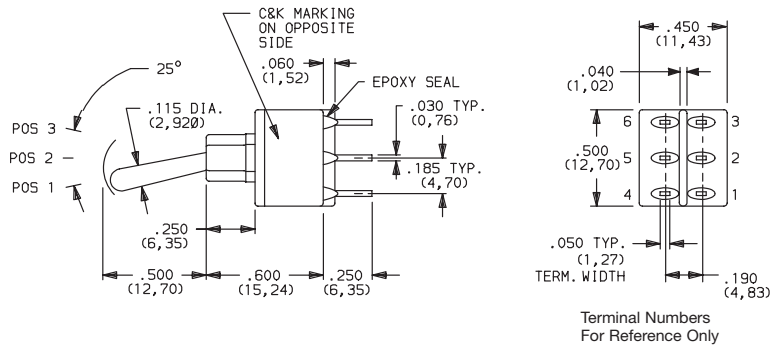

Part number shown: E201SD1CBE

MOM. = Momentary

\*\* Wiring for 3-way switch, see Section N.

All models with all options when ordered with G,R, Q or S contact material except with F1 conductive bushing.



F

Toggle

**C&K**



Dimensions are shown: Inches (mm)  
Specifications and dimensions subject to change

# E Series Sealed Miniature Toggle Switches

## SWITCH FUNCTION

NO. POLES	MODEL NO.	SWITCH FUNCTION			CONNECTED TERMINALS			SCHEMATIC
		POS. 1	POS. 2	POS. 3	POS. 1	POS. 2	POS. 3	
3P	E301	ON	NONE	ON	2-3-5-6,8-9	N/A	2-1,5-4,8-7	<p>3PDT</p>
3PDT		<p>C&amp;K MARKING ON OPPOSITE SIDE</p> <p>EPOXY SEAL</p>			<p>Terminal Nos. For Reference Only</p>			

MOM. = Momentary

\*\* Wiring for 3-way switch, see Section N.

All models with all options when ordered with G, R, Q or S contact material except with F1 conductive bushing.

## ACTUATOR

**M** .300" HIGH

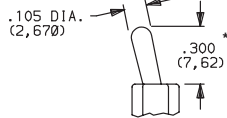

Standard when ordered with A, A3, AV2, AV3, V2-V61 terminations. Finish: Chrome.

**S** .500" HIGH

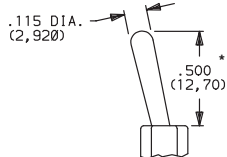

Standard when ordered with C, Z, Z3, W & W4 terminations. Finish: Chrome.

**L3** PLASTIC, .940" HIGH

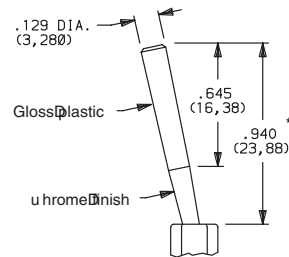

OPTION CODE	L3 ACTUATOR COLOR
2	BLACK

Other colors available, consult Customer Service Center. No color choice required for S & M actuators.

\* Actuators shown with standard D1 bushing. Subtract .030 (0,76) for D9 bushing. Subtract .100 (2,54) for Y bushing.

## BUSHING

**D1** .250" HIGH, UNTHREADED

**F1** ESD CONDUCTIVE BUSHING, .250" HIGH, UNTHREADED

F1 bushing is not UL/CSA approved

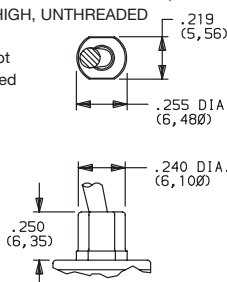

**ESD protection** depends on proper grounding of switch support bracket. F1 conductive bushing option is impregnated with carbon fibers; dissipates electrostatic discharge (ESD) up to 20,000 V from actuator to ground.

Available with M & S actuator options and A, A3, AV2, AV3, V3-V61 termination options.

**D9** .280" HIGH, UNTHREADED

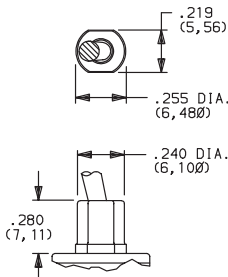

E3XX models not available with D9 bushing.

**NOTE:** Internal o-ring actuator seal standard for all bushing options.

**Y** THREADED, INSULATED, .350" HIGH WITH KEYWAY

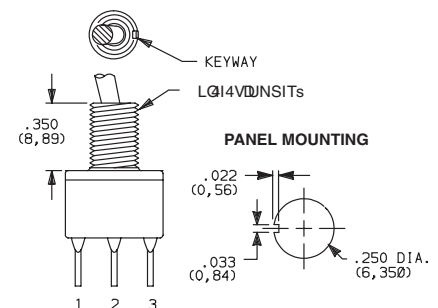

Available only with C, Z, Z3, & W terminations.

Available for 1&2 pole only.

Hardware: One dress nut part number 299D01201, one hex nut part number 540400201 and lockwasher part number 700303202 supplied standard.

**Will withstand 4 in.-lbs. of torque with no distortion.**



Dimensions are shown: Inches (mm)  
Specifications and dimensions subject to change



# E Series Sealed Miniature Toggle Switches

## TERMINATIONS

### Z SOLDER LUG

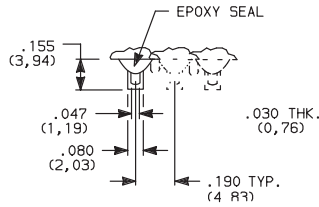

Not available with F1 conductive bushing or P, R or S contact material.

### SPDT thru 3PDT

### C PC THRU-HOLE

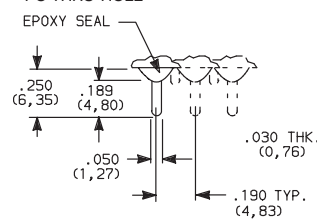

### PC MOUNTING

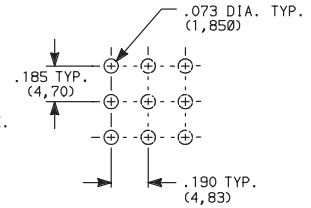

### SPDT thru 3PDT

Not available with F1 conductive bushing.

### Z3 QUICK CONNECT

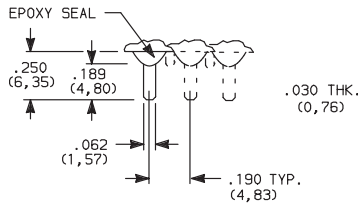

Not available with F1 conductive bushing or P, R or S contact material. Mating quick connector available; order part number 530100000, page F-26.

### SPDT thru 3PDT

### A RIGHT ANGLE, PC THRU-HOLE

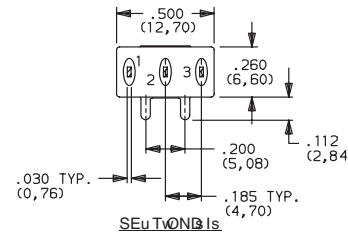
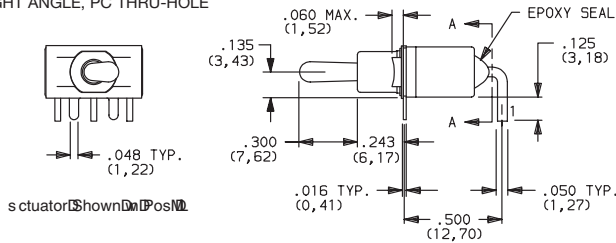

E101MD1ABE  
Horizontal Actuation  
SPDT

### A3 RIGHT ANGLE, SNAP-IN, PC THRU-HOLE

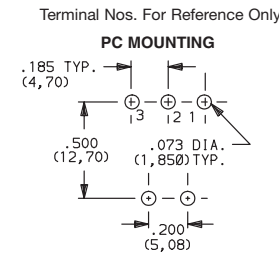
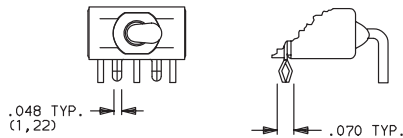

Not available with Y bushing.  
Terminal bend radii and lead-in manufacturing option.

### A RIGHT ANGLE, PC THRU-HOLE

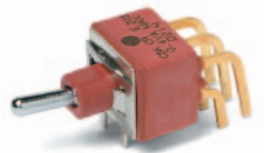
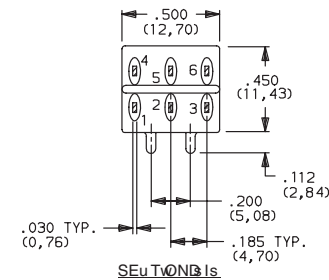
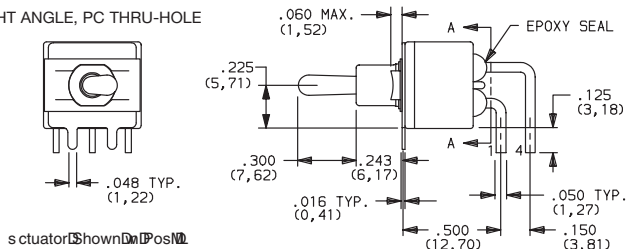

E201MD1ABE  
Horizontal Actuation  
DPDT

### A3 RIGHT ANGLE, SNAP-IN, PC THRU-HOLE

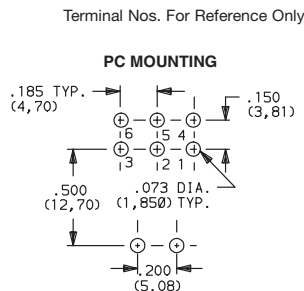
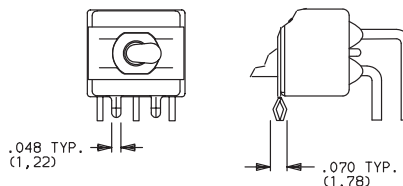

Not available with Y bushing.  
Terminal bend radii and lead-in manufacturing option.



Third Angle  
Projection

Dimensions are shown: Inches (mm)  
Specifications and dimensions subject to change

# E Series Sealed Miniature Toggle Switches

## TERMINATIONS

### A RIGHT ANGLE, PC THRU-HOLE

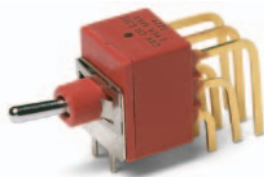

**E301MD1ABE**  
Horizontal Actuation  
**3PDT**

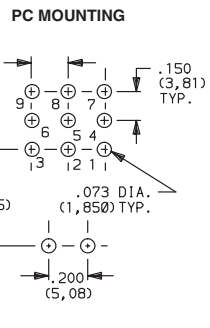
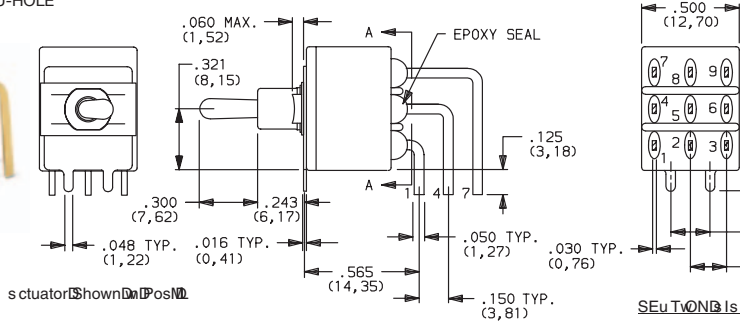

Not available with D9 & Y bushings.  
Terminal bend radii and lead-in manufacturing option.

### AV2 VERTICAL RIGHT ANGLE, PC THRU-HOLE, .150" PITCH



**E101MD1AV2BE**  
Vertical Actuation  
**SPDT**

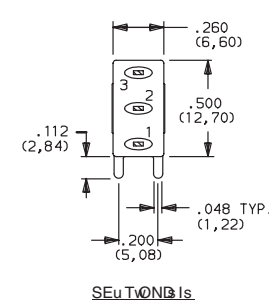
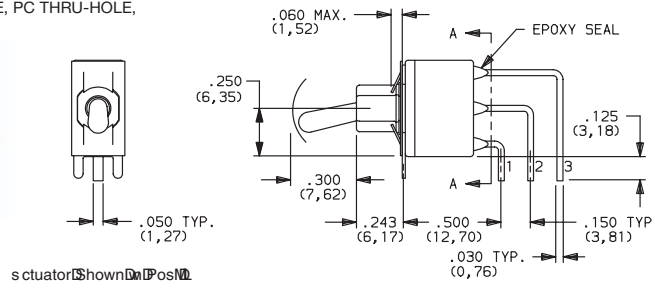

### AV3 VERTICAL RIGHT ANGLE, SNAP-IN, PC THRU-HOLE, .150" PITCH

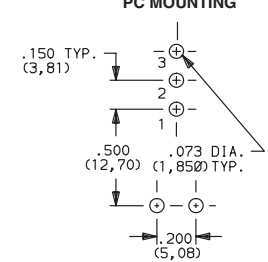

Not available with Y bushing.  
Terminal bend radii and lead-in manufacturing option.

### AV2 VERTICAL RIGHT ANGLE, PC THRU-HOLE, .150" PITCH



**E201MD1AV2BE**  
Vertical Actuation  
**DPDT**

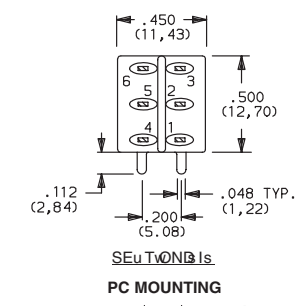
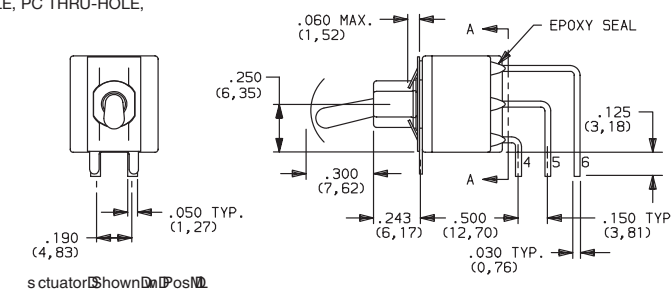

### A3 VERTICAL RIGHT ANGLE, SNAP-IN, PC THRU-HOLE, .150" PITCH

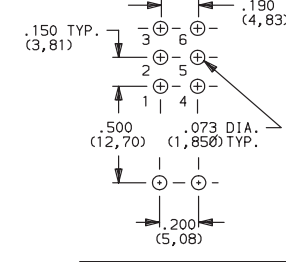

Not available with Y bushing.  
Terminal bend radii and lead-in manufacturing option.



Dimensions are shown: Inches (mm)  
Specifications and dimensions subject to change



# E Series Sealed Miniature Toggle Switches

## TERMINATIONS

**AV2** VERTICAL RIGHT ANGLE, PC THRU-HOLE, .150" PITCH

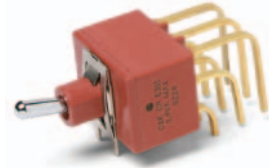
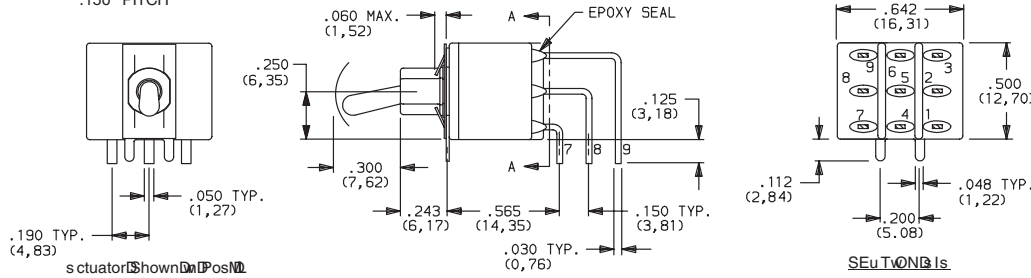

**E301MD1AV2BE**  
Vertical Actuation  
**3PDT**

**AV3** VERTICAL RIGHT ANGLE, SNAP-IN, PC THRU-HOLE, .150" PITCH

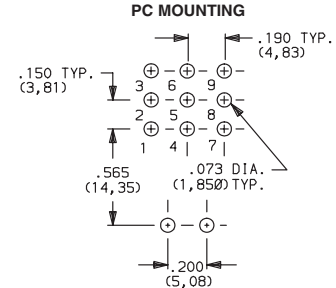

Not available with D9 & Y bushings.  
Terminal bend radii and lead-in manufacturing option.

**V6** VERTICAL MOUNT, V-BRACKET

**V61** VERTICAL MOUNT, V-BRACKET, SNAP-IN

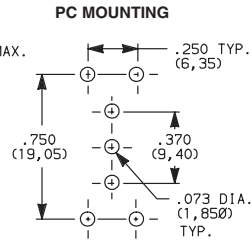
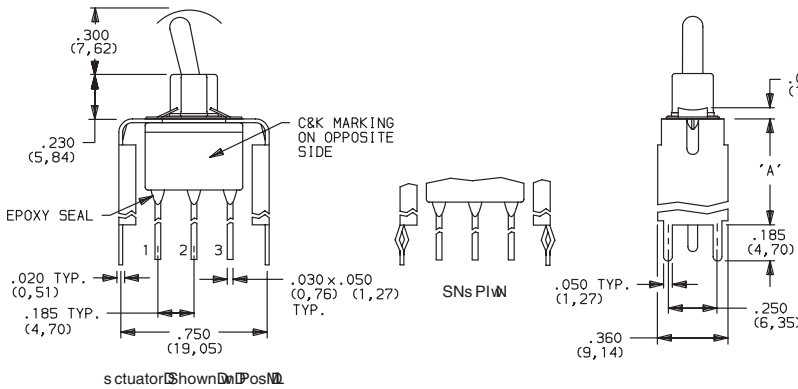

**E101MD1\_BE**  
**SPDT**

OPTION CODE	DIM 'A'
<b>V6, V61</b>	.460 (11,68)

Not available with Y bushing.

**V6** VERTICAL MOUNT, V-BRACKET

**V61** VERTICAL MOUNT, V-BRACKET, SNAP-IN

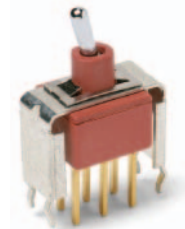
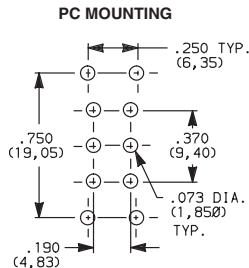
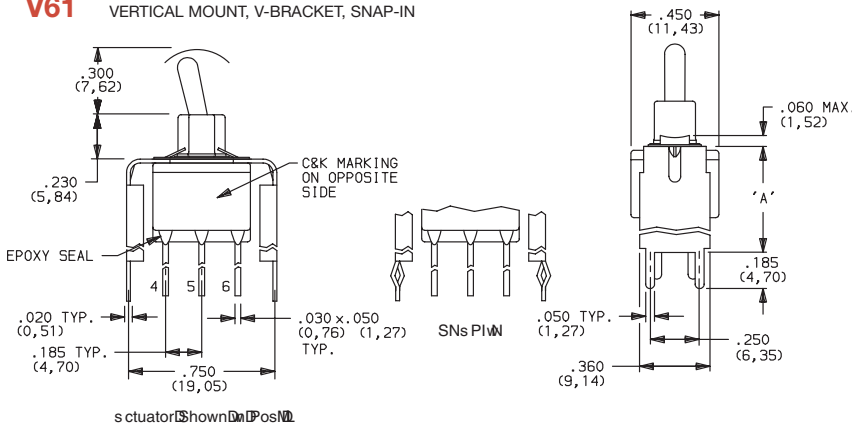

**E201MD1\_BE**  
**DPDT**

OPTION CODE	DIM 'A'
<b>V6, V61</b>	.460 (11,68)



Third Angle Projection

Dimensions are shown: Inches (mm)  
Specifications and dimensions subject to change

www.ck-components.com



# E Series Sealed Miniature Toggle Switches

## TERMINATIONS

**V3, V9** VERTICAL MOUNT, V-BRACKET

**V31** VERTICAL MOUNT, V-BRACKET, SNAP-IN

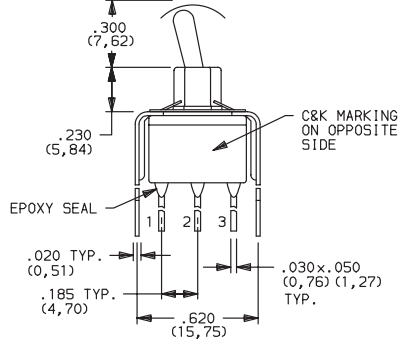

### PC MOUNTING

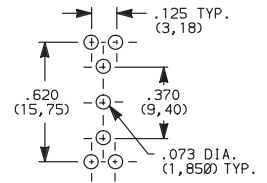

OPTION CODE	DIM 'A'
<b>V3, V31</b>	.460 (11,68)
<b>V9</b>	1.150 (29,21)

actuator shown in position

Not available with Y bushing.

**V3, V9** VERTICAL MOUNT, V-BRACKET

**V31** VERTICAL MOUNT, V-BRACKET, SNAP-IN

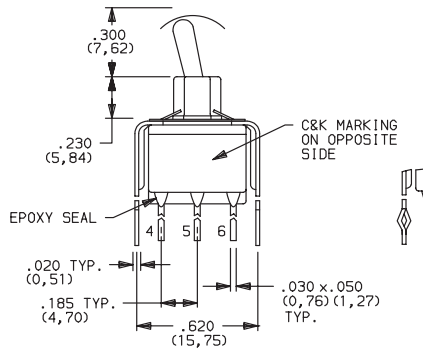

### PC MOUNTING

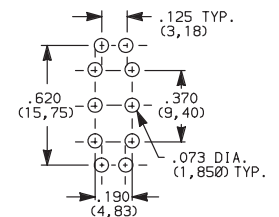

OPTION CODE	DIM 'A'
<b>V3, V31</b>	.460 (11,68)
<b>V9</b>	1.150 (29,21)

actuator shown in position

Not available with Y bushing.

**V9** VERTICAL MOUNT, V-BRACKET

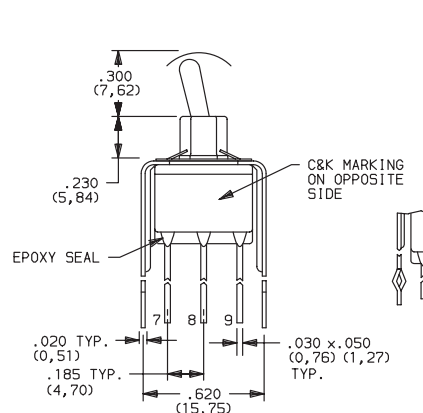
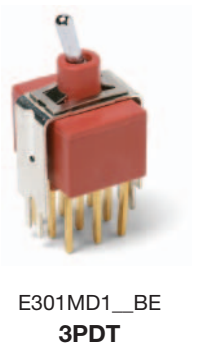

### PC MOUNTING

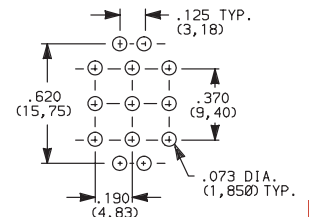

OPTION CODE	DIM 'A'
<b>V9</b>	1.150 (29,21)

actuator shown in position

Not available with D9 & Y bushings.



Dimensions are shown: Inches (mm)  
Specifications and dimensions subject to change





# E Series Sealed Miniature Toggle Switches

## CONTACT MATERIAL

OPTION CODE	CONTACT MATERIAL	TERMINAL PLATING	RATINGS	
<b>B</b>	GOLD <sup>1</sup>	GOLD <sup>1</sup>	LOW LEVEL/ DRY CIRCUIT	0.4 VA MAX. @ 20 V AC OR DC MAX.
<b>P</b>		MATTE-TIN <sup>6</sup>		
<b>Q</b>	SILVER <sup>4,5</sup>	SILVER <sup>5</sup>	POWER	E1XX & E2XX MODELS: 7.5 AMPS @ 125 V AC OR 28 V DC; 3 AMPS @ 250 V AC. E3XX MODELS: 5 AMPS @ 125 V AC OR 28 V DC; 2 AMPS @ 250 V AC.
<b>S</b>		MATTE-TIN <sup>6</sup>		
<b>G</b>	GOLD OVER SILVER <sup>2,3</sup>	GOLD <sup>3</sup>	LOW LEVEL/DRY CIRCUIT OR POWER	E1XX AND E2XX MODELS: 0.4 VA MAX @20 V AC OR DC MAX. OR 7.5 AMPS @125 V AC OR 28 V DC; 3 AMPS @ 250 V AC. DC E3XX MODELS: 0.4 VA MAX. @ 20 V AC OR DC MAX. OR 5 AMPS @ 125 V AC OR 28 V DC; 2 AMPS @ 250 V AC.
<b>R</b>		MATTE-TIN <sup>6</sup>		

\* Note: See Technical Data section of this catalog for RoHS compliant and compatible definitions and specifications.

<sup>1</sup> CONTACTS & TERMINALS: Copper alloy, with gold plate over nickel plate.

<sup>2</sup> END CONTACTS: Coin silver, with gold plate over nickel plate.

<sup>3</sup> CENTER CONTACTS & ALL TERMINALS: Copper alloy, with gold plate over nickel plate.

<sup>4</sup> END CONTACTS: Coin silver, silver plated.

<sup>5</sup> CENTER CONTACT & ALL TERMINALS: Copper alloy, with gold flash over silver plate. Or copper alloy, silver plated.

<sup>6</sup> TERMINALS: Copper alloy, with matte-tin over nickel plate.

**NOTE: Any models supplied with P, S, R, Q, B or G contact material are RoHS compliant.**

All models  with all options when ordered with S, R, G, or Q contact material except with F1 conductive bushing.

B contact material standard with all terminations.

P, S & R contact materials not available with Z & Z3 terminations.



F

Toggle

**C&K**



Third Angle  
Projection

Dimensions are shown: Inches (mm)  
Specifications and dimensions subject to change

# ET Series Sealed Subminiature Toggle Switches

## Features/Benefits

- Sealed against solder and cleaning process contaminants
- ESD protection available
- Thru-hole and surface mount models
- Compact size and small footprint save PCB space
- RoHS compliant models available



## Typical Applications

- Hand-held telecommunications
- Instrumentation
- Medical equipment

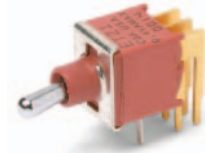

## Specifications

**CONTACT RATING:** B contact material: 0.4 VA max. @ 20 V AC or DC max. See page F-35 for additional ratings.

**ELECTRICAL LIFE:** ETX1 models: 60,000 make-and-break cycles at full load. All other models: 30,000 cycles.

**CONTACT RESISTANCE:** Below 20 m Ω typ. initial @ 2-4 V DC, 100 mA, for both silver and gold plated contacts.

**INSULATION RESISTANCE:** 10<sup>9</sup> Ω min.

**ELECTROSTATIC DISCHARGE (ESD) RESISTANT OPTION:**  
M3 & S3 insulating actuator only: 9,000 V DC min. @ sea level, actuator to terminals. F1 conductive bushing only: Dissipates up to 20,000 V DC from actuator to ground. M3 & S3 actuator and F1 bushing options are not recommended for use together.

**DIELECTRIC STRENGTH:** 1000 Vrms min. @ sea level.

**OPERATING TEMPERATURE:** -30°C to 85°C.

**SOLDERABILITY:** Per MIL-STD-202F method 208D, or EIA RS-186E method 9 (1 hour steam aging).

**DEGREE OF PROTECTION:** IP57; Protection against harmful dust deposit, full-scale voltage protection, temporary immersion.

**PACKAGING:** Surface mount switches are shipped in tape and reel packaging, see page F-31 for drawings and reel information.

## Materials

**CASE & BUSHING:** Glass filled nylon 6/6, flame retardant, heat stabilized (UL 94V-0) or glass filled 4/6 nylon, flame retardant, heat stabilized (UL 94V-0). F1 conductive bushing option is impregnated with carbon fibers.

**ACTUATOR:** M3 & S3 anti-static actuator: Nylon 4/6, black standard (UL 94V-0). All other actuators: Brass, chrome plated. Internal o-ring seal standard with all actuators.

**SWITCH SUPPORT:** Brass, tin plated.

**CONTACTS & TERMINALS:** B contact material: Copper alloy, with gold plate over nickel plate. Q contact material: Copper alloy, silver plated. See F-35 for additional contact materials.

**TERMINAL SEAL:** Epoxy.

**NOTE:** Any models supplied with Q, B, G, P or R contact material are RoHS compliant and compatible.

**NOTE:** Specifications and materials listed above are for switches with standard options. For information on specific and custom switches, consult Customer Service Center.

## Build-A-Switch

To order, simply select desired option from each category and place in the appropriate box. Available options are shown and described on pages F-26 thru F-31. For additional options not shown in catalog, consult our Customer Service Center. All models are process sealed to withstand machine soldering temperatures and pressure wash cleaning methods.

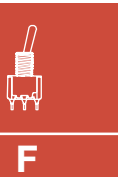
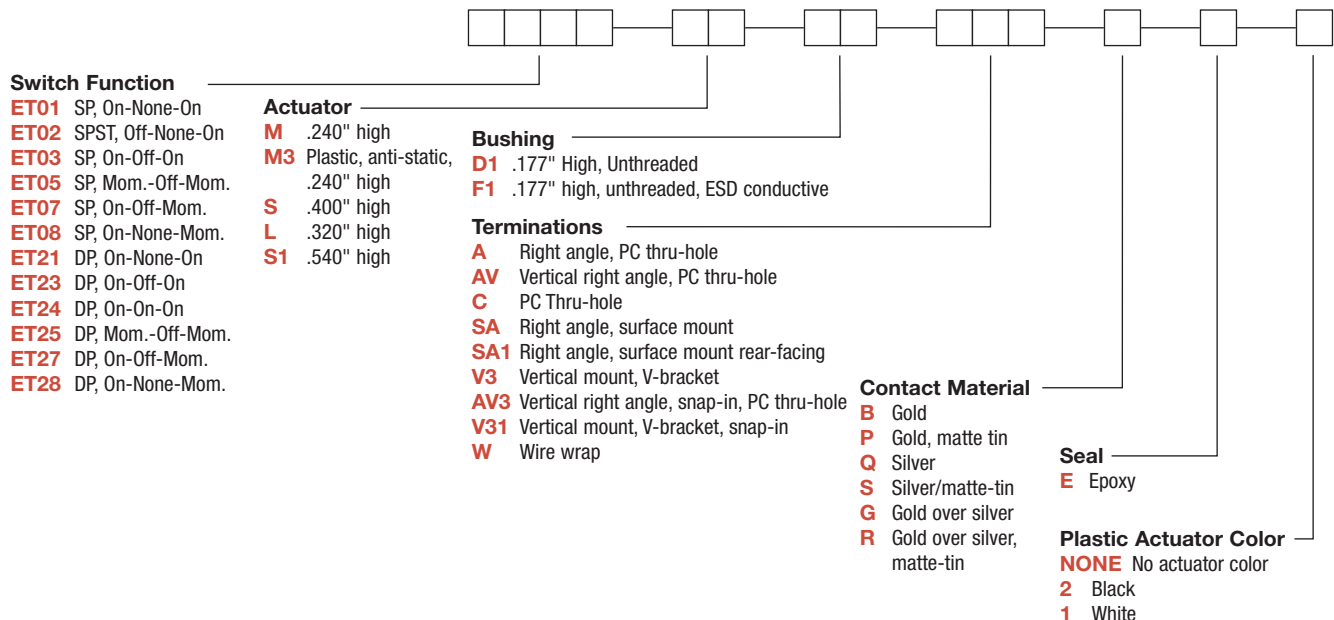

**F**  
Toggle



Dimensions are shown: Inches (mm)  
Specifications and dimensions subject to change

# ET Series Sealed Subminiature Toggle Switches

## SWITCH FUNCTION

NO. POLES	MODEL NO.	SWITCH FUNCTION			CONNECTED TERMINALS			SCHEMATIC
		POS. 1	POS. 2	POS. 3	POS. 1	POS. 2	POS. 3	
SP	<b>ET01</b>	ON	NONE	ON	2-3	N/A	2-1	
	<b>ET03</b>	ON	OFF	ON	2-3	OPEN	2-1	
	<b>ET05</b>	MOM.	OFF	MOM.				
	<b>ET07</b>	ON	OFF	MOM.				
	<b>ET08</b>	ON	NONE	MOM.	2-3	N/A	2-1	
	<b>ET02</b>	OFF	NONE	ON	OPEN	N/A	3-1	
<p><b>SPDT</b></p> <p>Part number shown: ET01MD1CBE      ET02 Models: Omit terminal 2</p>								
DP	<b>ET21</b>	ON	NONE	ON	2-3,5-6	N/A	2-1,5-4	
	<b>ET23</b>	ON	OFF	ON	2-3,5-6	OPEN	2-1,5-4	
	<b>ET25</b>	MOM.	OFF	MOM.				
	<b>ET27</b>	ON	OFF	MOM.				
	<b>ET28</b>	ON	NONE	MOM.	2-3,5-6	N/A	2-1,5-4	
	<b>ET24**</b>	ON	ON	ON	2-3,5-6	2-3,5-4	2-1,5-4	DPDT
<p><b>DPDT</b></p> <p>Part number shown: ET21MD1CBE</p>								

MOM. = Momentary

\*\* Wiring for 3-way switch, see Section N.

All models with all options (except M3 actuator) when ordered with G, L, R or Q contact material except with F1 conductive bushing.



F

Toggle



Dimensions are shown: Inches (mm)  
Specifications and dimensions subject to change

# ET Series Sealed Subminiature Toggle Switches

## ACTUATOR ACTUATOR COLOR

**M** .240" HIGH

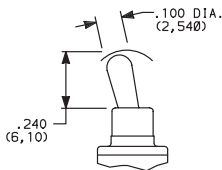

Standard with A, AV, V3 & V31 terminations.

**M3** PLASTIC, ANTISTATIC, .240" HIGH

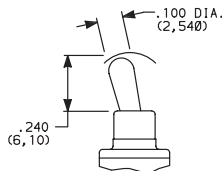

Material: Nylon 4/6 (UL 94V-0), black standard. Static resistance: 9,000 V DC min. @ sea level, actuator to terminals. Not available with F1 conductive bushing option. Not UL approved.

**S** .400" HIGH

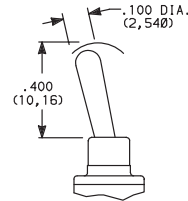

Standard with C or W terminations.

**L** .320" HIGH

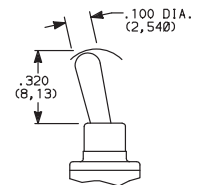

**S1** .540" HIGH

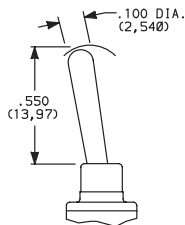

OPTION CODE	PLASTIC ACTUATOR COLOR
(NONE)	BLACK (M3 & S3 only)
1	WHITE (M3 & S3 only)

**NOTE:** All actuators have chrome finish (except M3 & S3).

## BUSHING

**D1** .177" HIGH, UNTHREADED

**F1** ESD, CONDUCTIVE BUSHING UNTHREADED, .177" HIGH

F1 bushing is not UL/CSA approved

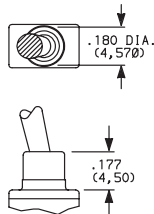

**NOTE:** ESD protection depends on proper grounding of switch support bracket. F1 conductive bushing option is impregnated with carbon fibers; dissipates electrostatic discharge (ESD) up to 20,000 V from actuator to ground.

Available with all metal actuator options and A, AV, AV3, V3 and V31 termination options only.

Internal actuator o-ring seal standard.

## TERMINATIONS

**C** PC THRU-HOLE

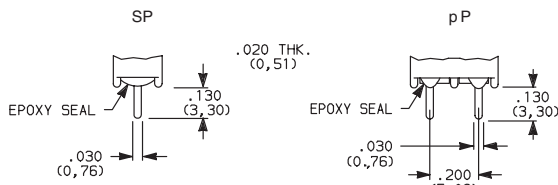

PC MOUNTING

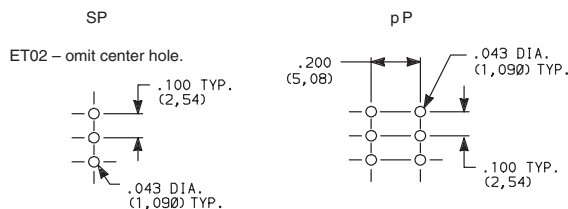

SP and DP

Not available with F1 conductive bushing.

**W** WIRE WRAP

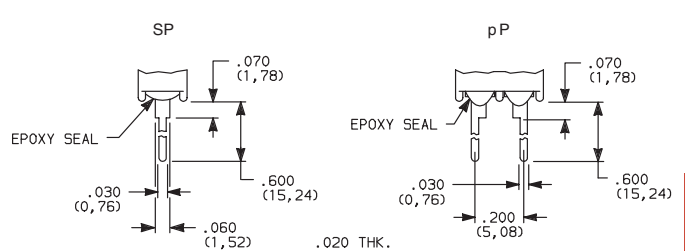

SP and DP

Not available with F1 conductive bushing.



Dimensions are shown: Inches (mm)  
Specifications and dimensions subject to change



F

Toggle

# ET Series Sealed Subminiature Toggle Switches

## TERMINATIONS

**A** RIGHT ANGLE, PC THRU-HOLE

**ET01MD1ABE**  
Horizontal Actuation  
**SPDT**

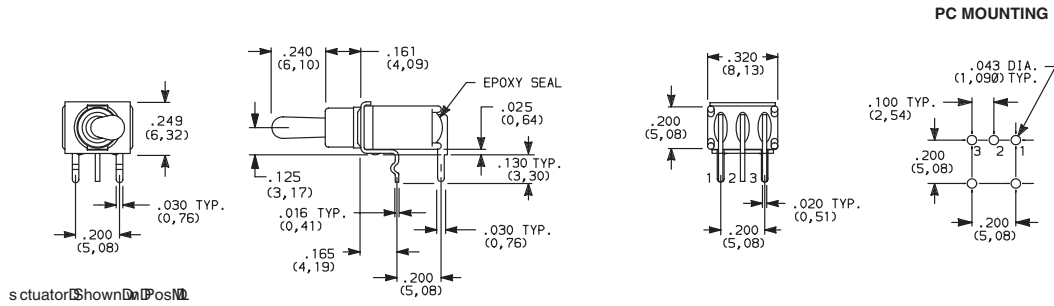

Not available with ET02 model.

**A** RIGHT ANGLE, PC THRU-HOLE

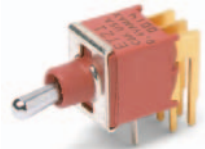

**ET21MD1ABE**  
Horizontal Actuation  
**DPDT**

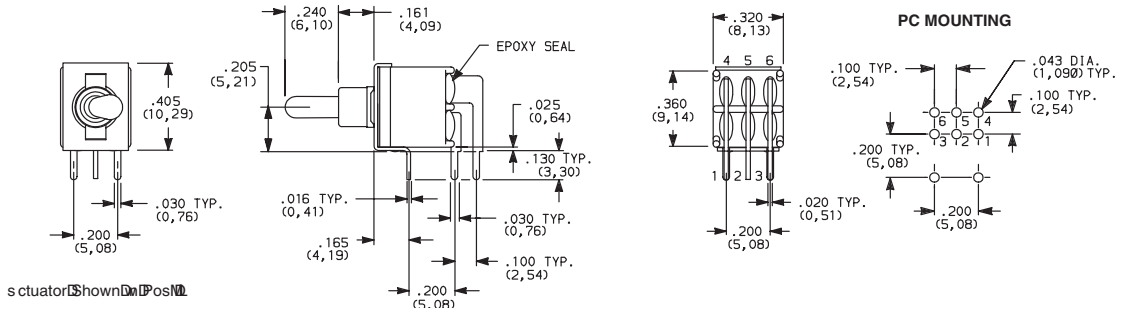

**AV** VERTICAL RIGHT ANGLE, PC THRU-HOLE



**ET01MD1AVBE**  
Vertical Actuation  
**SPDT**

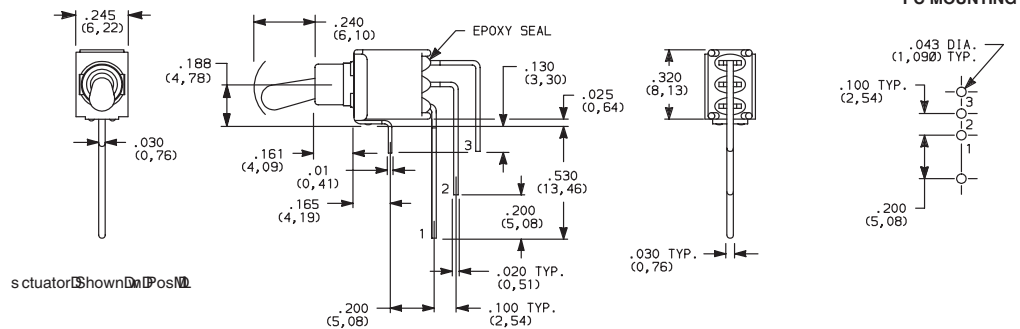

ET02 - omit terminal 2.

**NOTE:** Terminal bend radii and lead-in manufacturing option.

**AV** VERTICAL RIGHT ANGLE, PC THRU-HOLE

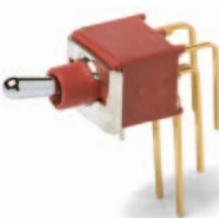

**ET21MD1AVBE**  
Vertical Actuation  
**DPDT**

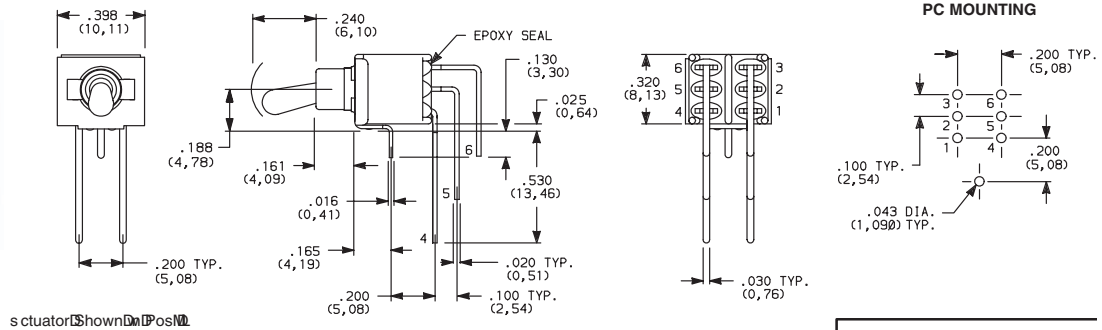

**NOTE:** Terminal bend radii and lead-in manufacturing option.



Dimensions are shown: Inches (mm)  
Specifications and dimensions subject to change

# ET Series Sealed Subminiature Toggle Switches

## TERMINATIONS

### AV3 VERTICAL RIGHT ANGLE, SNAP-IN, PC THRU-HOLE

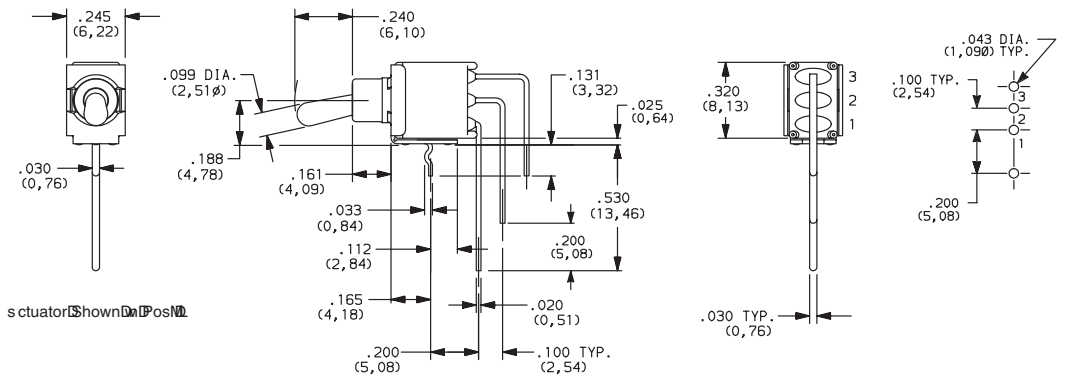

### SA RIGHT ANGLE, SURFACE MOUNT

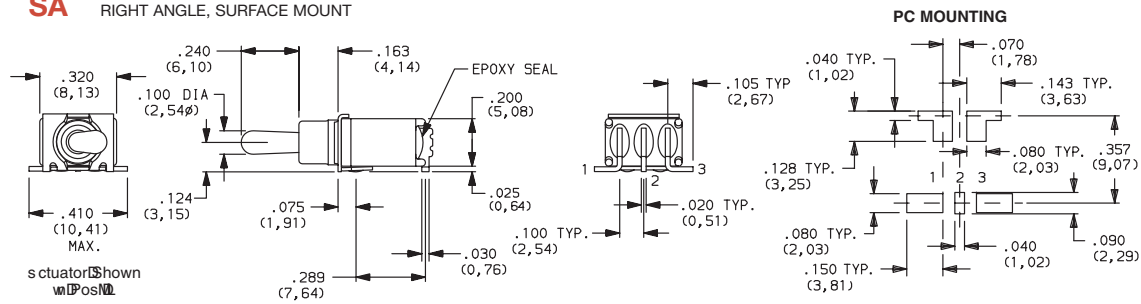

Not available with S and S1 actuators. Standard with tape & reel packaging. See page F-31.

### SA1 RIGHT ANGLE, SURFACE MOUNT

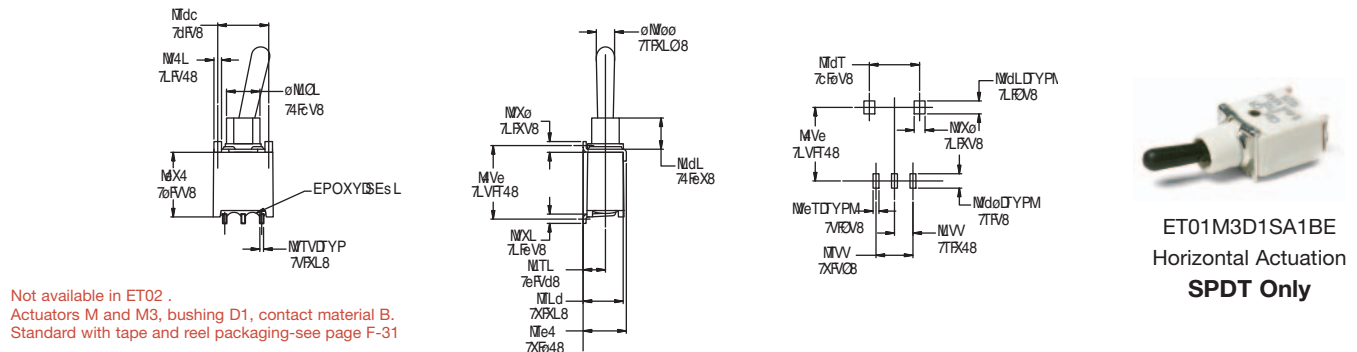

Not available in ET02.  
Actuators M and M3, bushing D1, contact material B.  
Standard with tape and reel packaging-see page F-31

### V3 VERTICAL MOUNT, V-BRACKET

### V31 VERTICAL MOUNT, V-BRACKET, SNAP-IN

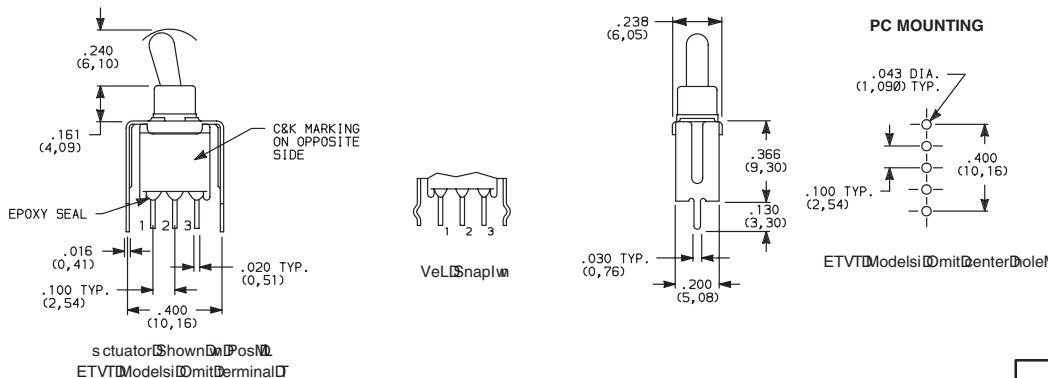

ETVTModelsImitDerminalD



Dimensions are shown: Inches (mm)  
Specifications and dimensions subject to change



F

Toggle

# ET Series Sealed Subminiature Toggle Switches

## TERMINATIONS

### V3 VERTICAL MOUNT, V-BRACKET

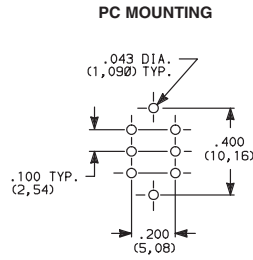
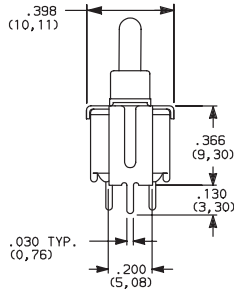
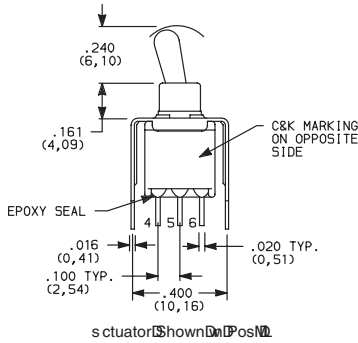

ET21MD1V3BE  
DPDT

## CONTACT MATERIAL

OPTION CODE	CONTACT MATERIAL	TERMINAL PLATING	RATINGS	
B	GOLD <sup>1</sup>	GOLD <sup>1</sup>	LOW LEVEL/DRY CIRCUIT	0.4 VA MAX. @ 20 V AC OR DC MAX.
P		MATTE-TIN <sup>6</sup>		
Q	SILVER <sup>4,5</sup>	SILVER <sup>5</sup>	POWER	ETX1 MODELS: 3 AMPS @ 120 V AC OR 28 V DC ALL OTHER MODELS: 2 AMPS @ 120 V AC OR 28 V DC
S		MATTE-TIN <sup>6</sup>		
G	GOLD OVER SILVER <sup>2,3</sup>	GOLD <sup>3</sup>	LOW LEVEL/DRY CIRCUIT OR POWER	ETX1 MODELS: 0.4 VA MAX. @ 20 V AC OR DC MAX. OR 3 AMPS @ 120 V AC OR 28 V DC ALL OTHER MODELS: 0.4 VA MAX. @ 20 V AC OR DC MAX. OR 2 AMPS @ 120 V AC OR 28 V DC
R		MATTE-TIN <sup>6</sup>		

\* Note: See Technical Data section of this catalog for RoHS compliant and compatible definitions and specifications.

<sup>1</sup> CONTACTS & TERMINALS: Copper alloy, with gold plate over nickel plate.

<sup>2</sup> END CONTACTS: Coin silver, with gold plate over nickel plate.

<sup>3</sup> CENTER CONTACTS & ALL TERMINALS: Copper alloy, with gold plate over nickel plate.

<sup>4</sup> END CONTACTS: Coin silver, silver plated.

<sup>5</sup> CENTER CONTACT & ALL TERMINALS: Copper alloy, silver plated.

<sup>6</sup> TERMINALS: Copper alloy, with matte tin over nickel plate.

**NOTE:** Any models supplied with Q, B, G, P or R contact material are RoHS compliant.

All models with all options (except M3 actuator) when ordered with G, L, R or Q contact material except with F1 conductive bushing.

## SEAL

### E EPOXY SEAL

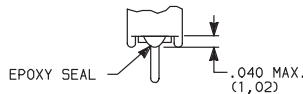

## AVAILABLE HARDWARE

### Cap

**PART NO.**  
706201000 WHITE  
706202000 BLACK  
706203000 RED

Material: Vinyl  
Finish: Matte

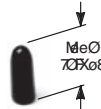

**NOTE:** Other colors available, consult Customer Service Center.



Third Angle  
Projection

Dimensions are shown: Inches (mm)  
Specifications and dimensions subject to change

www.ck-components.com



# ET Series Sealed Subminiature Toggle Switches

## TAPE & REEL

For part number ET01M3D1SAKE

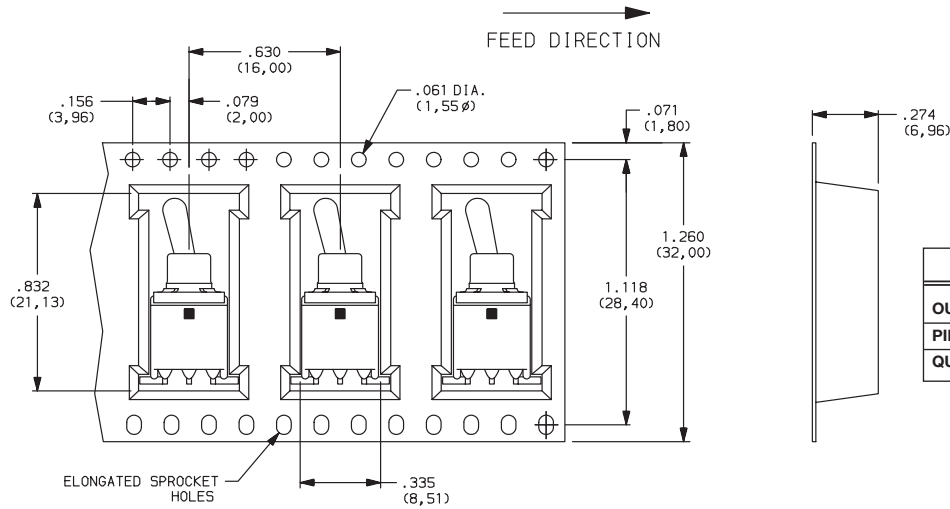

REEL INFORMATION	
OUTSIDE DIAMETER	13.00 (330,0)
PILOT HOLE	.512 (13,0)
QUANTITY PER REEL	600

For part number ET01M3D1SA1BE

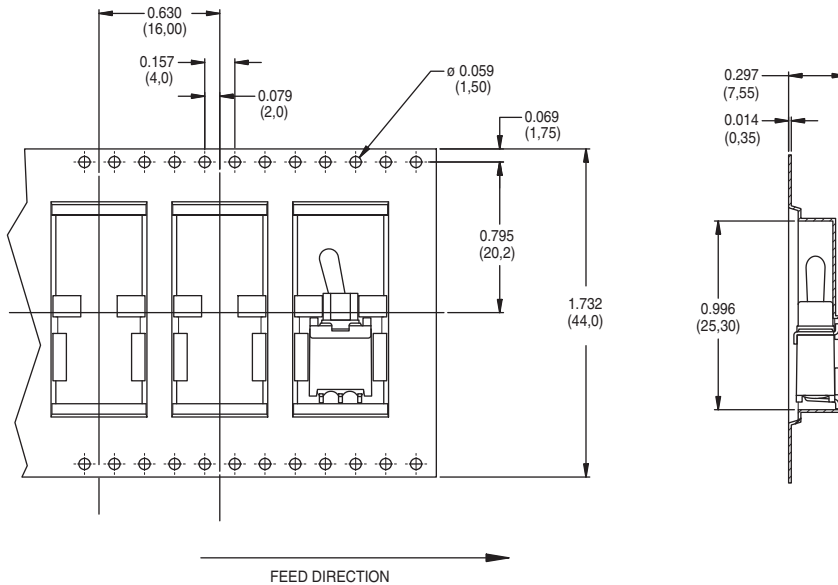

REEL INFORMATION	
OUTSIDE DIAMETER	13.00 (330,0)
PILOT HOLE	.795 (20,20)
QUANTITY PER REEL	500

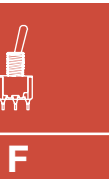
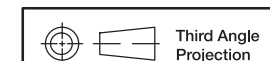

# T Series Subminiature Toggle Switches

## Features/Benefits

- Compact size—small footprint
- Single and double pole models
- PC and panel mount options available
- RoHS compliant models available

## Typical Applications

- Hand-held telecommunications
- Instrumentation
- Medical equipment

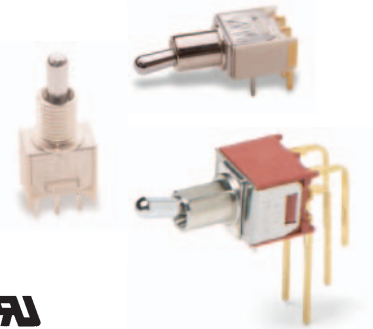

Models Available

## Specifications

CONTACT RATING: B contact material: 0.4 VA max. @ 20 V AC or DC max. Q contact material (TX01 models): 3 AMPS @ 120 V AC or 28 V DC. All other models: 2 AMPS @ 120 V AC or 28 V DC. See page F-42 for additional ratings.

ELECTRICAL LIFE: TX01 models: 60,000 make-and-break cycles at full load. All other models: 30,000 cycles.

CONTACT RESISTANCE: Below 20 m Ω typ. initial @ 2-4 V DC, 100 mA, for both silver and gold plated contacts.

INSULATION RESISTANCE: 10<sup>9</sup> Ω min.

DIELECTRIC STRENGTH: 1000 Vrms min. @ sea level.

OPERATING TEMPERATURE: -30°C to 85°C.

SOLDERABILITY: Per MIL-STD-202F method 208D, or EIA RS-186E method 9 (1 hour steam aging).

**NOTE:** Any models supplied with P, R, Q, B or G contact material are RoHS compliant and compatible.

**NOTE:** Specifications and materials listed above are for switches with standard options. For information on specific and custom switches, consult Customer Service Center.

## Materials

CASE: Glass filled nylon 6/6, flame retardant, heat stabilized or diallyl phthalate (DAP), (UL 94V-0) or glass filled nylon 4/6, flame retardant, heat stabilized.

ACTUATOR: Brass, chrome plated.

BUSHING: Brass, nickel plated.

HOUSING: Stainless steel.

SWITCH SUPPORT: Brass, matte-tin plated.

END CONTACTS: B contact material: Copper alloy, with gold plate over nickel plate. Q contact material: Coin silver, silver plated. See above for additional contact materials.

CENTER CONTACTS & TERMINALS: B contact material: Copper alloy, with gold plate over nickel plate. Q contact material: Copper alloy, silver plated. See page F-42 for additional contact materials.

TERMINAL SEAL: Epoxy.

HARDWARE: Nut & Locking Ring: Brass, nickel plated.

Lockwasher: Steel, nickel plated. Additional hardware available separately, see Section N.

## Build-A-Switch

To order, simply select desired option from each category and place in the appropriate box. Available options are shown and described on pages F-33 thru F-37. For additional options not shown in catalog, consult Customer Service Center. All models have epoxy terminal seal and are compatible with all "bottom-wash" PCB cleaning methods.

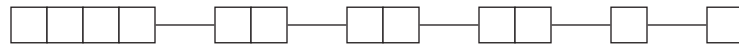

### Switch Function

- T101** SPDT On-None-On
- T102** SPDT Off-None-On
- T103** SPDT On-Off-On
- T105** SPDT Mom.-Off-Mom.
- T107** SPDT On-Off-Mom.
- T108** SPDT On-None-Mom.
- T201** DPDT On-None-On
- T203** DPDT On-Off-On
- T205** DPDT Mom.-Off-Mom.
- T207** DPDT On-Off-Mom.
- T208** DPDT On-None-Mom.
- T211** DPDT On-On-On.

### Actuator

- P3** Flatted, anti-rotation, .490" high
- S** .370" high
- K** Locking lever, round tip
- L1** .620" high
- M1** .220" high
- S1** .410" high
- M** .210" high
- L** .290" high

### Bushing

- H** .220" high, threaded, flat
- H9** .220" high, unthreaded, flat
- CF** Splashproof, .310" high, threaded, flat
- D9** .260" high, unthreaded, keyway
- T** .310" high, threaded, flat
- T9** .310" high, unthreaded, flat
- TD** .260" high, threaded, keyway
- TK** .310" high, threaded, keyway
- Y** .220" high, threaded, keyway
- Y9** .220" high, unthreaded, keyway

### Terminations

- A** Right angle, PC thru-hole
- AV** Vertical right angle, PC thru-hole
- C** PC Thru-hole
- V3** Vertical mount V-bracket
- Z** Solder lug
- W** Wire wrap

### Contact Material

- B** Gold
- P** Gold, matte tin
- Q** Silver
- G** Gold over silver
- R** Gold over silver, matte-tin

### Seal

- E** Epoxy



F

Toggle



Dimensions are shown: Inches (mm)  
Specifications and dimensions subject to change

# T Series Subminiature Toggle Switches

## SWITCH FUNCTION

NO. POLES	MODEL NO.	SWITCH FUNCTION			CONNECTED TERMINALS			SCHEMATIC
		POS. 1	POS. 2	POS. 3	POS. 1	POS. 2	POS. 3	
SP	T101	ON	NONE	ON	2-3	N/A	2-1	
	T103	ON	OFF	ON	2-3	OPEN	2-1	
	T105	MOM.	OFF	MOM.				
	T107	ON	OFF	MOM.				
	T108	ON	NONE	MOM.	2-3	NA	2-1	
	T102	OFF	NONE	ON	OPEN	N/A	3-1	

### SPDT

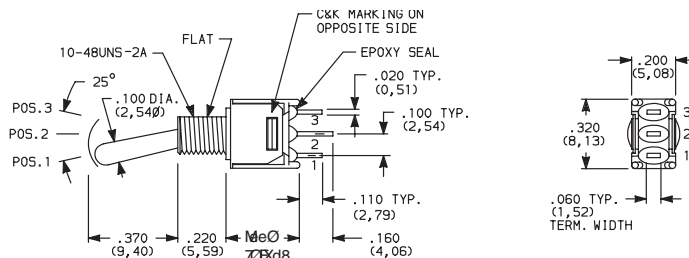

Part number shown: T101SHZQE

NO. POLES	MODEL NO.	SWITCH FUNCTION			CONNECTED TERMINALS			SCHEMATIC
		POS. 1	POS. 2	POS. 3	POS. 1	POS. 2	POS. 3	
DP	T201	ON	NONE	ON	2-3,5-6	N/A	2-1,5-4	
	T203	ON	OFF	ON	2-3,5-6	OPEN	2-1,5-4	
	T205	MOM.	OFF	MOM.				
	T208	ON	NONE	MOM.	2-3,5-6	N/A	2-1,5-4	
	T211*	ON	ON	ON	2-3,5-6	2-3,5-4	2-1,5-4	

### DPDT

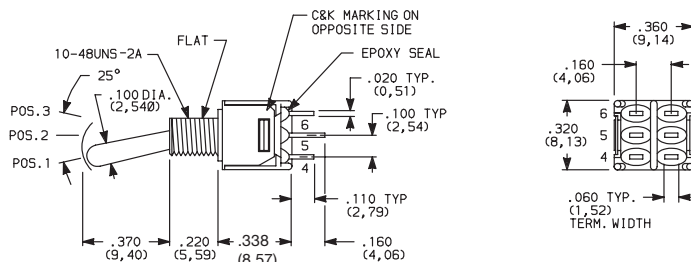

Part number shown: T201SHZQE

Terminal Nos.  
For Reference Only

MOM. = Momentary

All models with all options when ordered with G, L, R or Q contact material.



Third Angle  
Projection

Dimensions are shown: Inches (mm)  
Specifications and dimensions subject to change



Toggle

# T Series Subminiature Toggle Switches

## ACTUATOR

**M** .210" HIGH

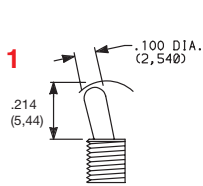

Standard with A, AV or V3 terminations.

**S** .370" HIGH

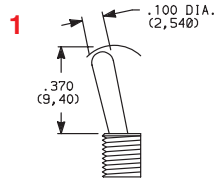

Standard with Z, C or W terminations.

**M1** .220" HIGH  
(with "T" bushing)

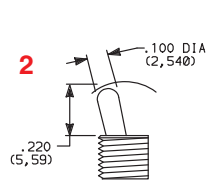

**S1** .410" HIGH  
(with "T" bushing)

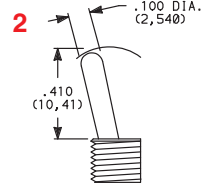

**L** .290" HIGH

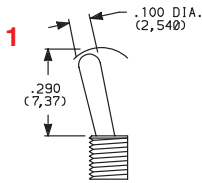

**L1** .620" HIGH

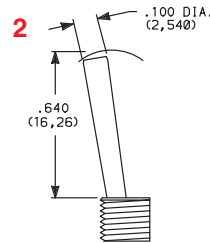

**P3** ANTI-ROTATION, FLATTED,  
.450" HIGH

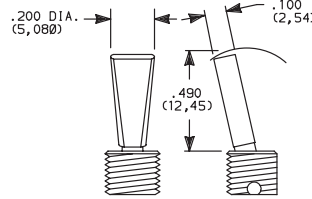

Available with T & T9 bushings only.  
Dress nut part number 709901201  
supplied standard with threaded bushing.

1 Actuator shown with standard H bushing.  
Subtract .040 (1,02) for TD and D9 bushings,  
subtract .090 (2,29) for T, T9, TK, K9 &  
CF bushings.

2 Actuators shown with T, T9, TK & CF bushings,  
add .050 (1,27) for TD and D9 bushings,  
add .090 (2,29) for H, H9, Y & Y9 bushings.

All actuators have chrome finish (except K).

## K LOCKING LEVER

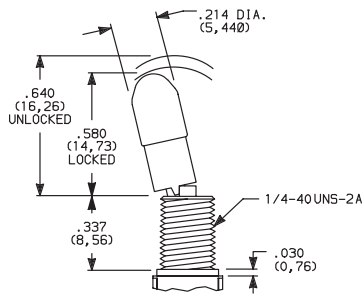

Not available with CF bushing option.

Bushing option code not required. Not available with TX05 & TX07 models.

### Locking Positions



-01 & -02 Models  
2 Position lock



-03 & -11 Models  
3 Position lock



-08 Models  
1 Position lock

K actuators have natural aluminum finish.

Keyway on right side. To prevent accidental actuation, toggles  
must be lifted before being actuated. When released, toggles  
again lock in place. Overtightening mounting nut may cause  
actuator to bind.

## BUSHING

**H** .220" HIGH THREADED, FLAT

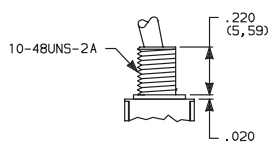
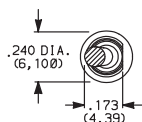

H standard with C, W & Z terminations.

H9 standard with A, AV & V3 terminations.

**Y** .220" HIGH THREADED, KEYWAY

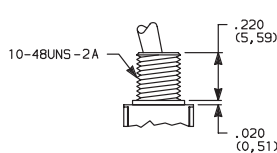
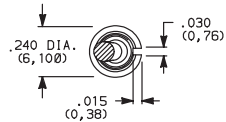

**T** .310" HIGH THREADED, FLAT

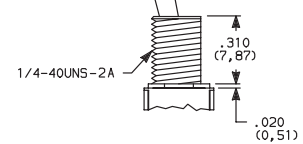
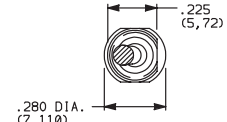

**Y9** .220" HIGH UNTHREADED, KEYWAY

**T9** .310" HIGH UNTHREADED, FLAT



Third Angle  
Projection

Dimensions are shown: Inches (mm)  
Specifications and dimensions subject to change

# T Series Subminiature Toggle Switches

## BUSHING

**TK** .310" HIGH THREADED, KEYWAY

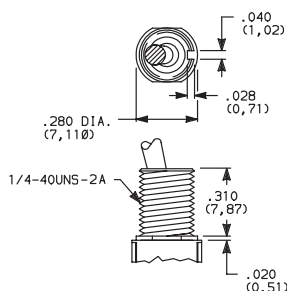

**TD** .260" HIGH THREADED, KEYWAY

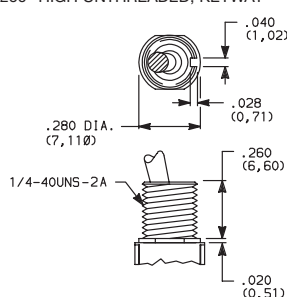

**D9** .260" HIGH UNTHREADED, KEYWAY

**CF** SPLASHPROOF, .310" HIGH THREADED, FLAT

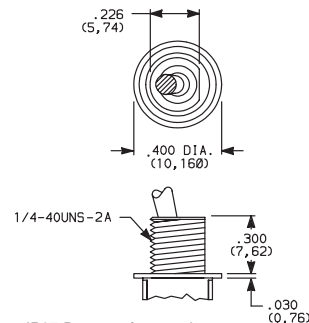

IP67 Degree of protection.  
Internal o-ring actuator seal and external bushing seal washer standard.

Not available with K locking lever option.

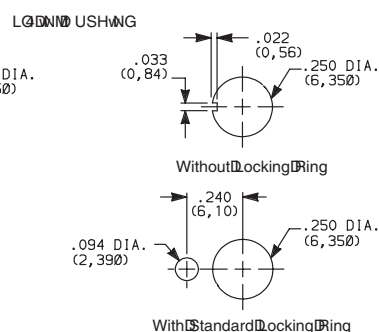
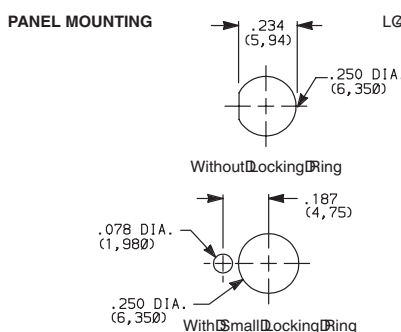
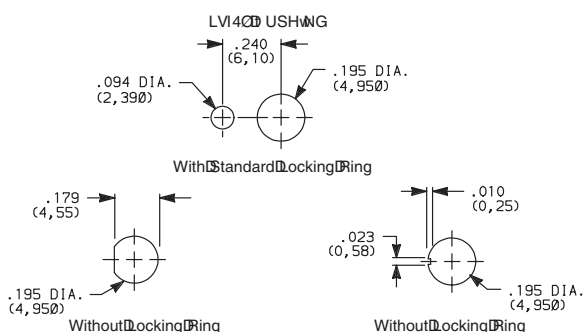

## TERMINATIONS

**Z** SOLDER LUG

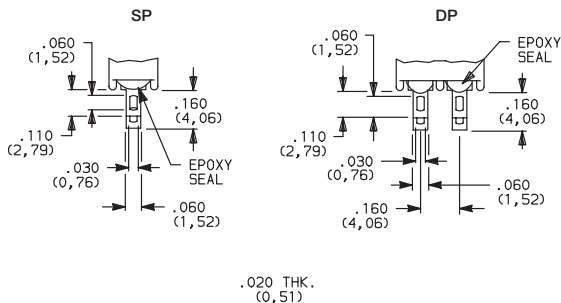

Not available with P or R contact materials.

**C** PC THRU-HOLE

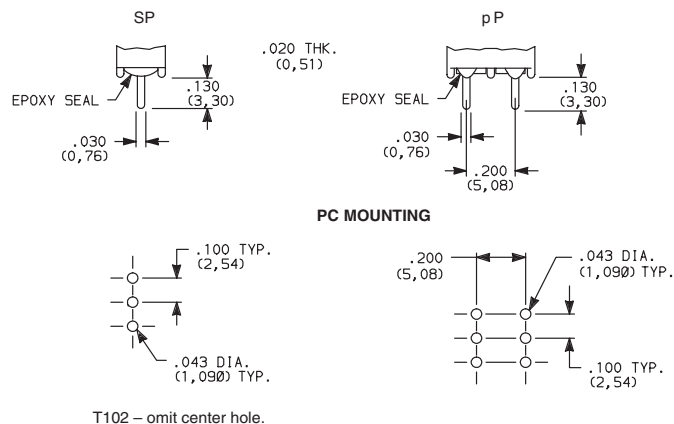

T102 - omit center hole.

**W** WIRE WRAP

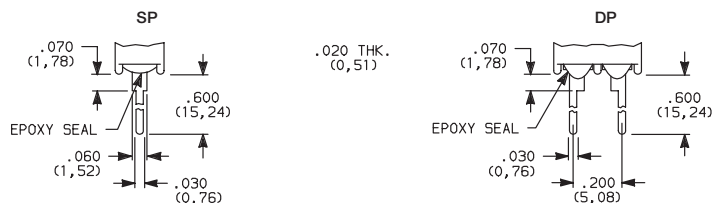

Third Angle Projection  
Dimensions are shown: Inches (mm)  
Specifications and dimensions subject to change



# T Series Subminiature Toggle Switches

## TERMINATIONS

### A RIGHT ANGLE, PC THRU-HOLE

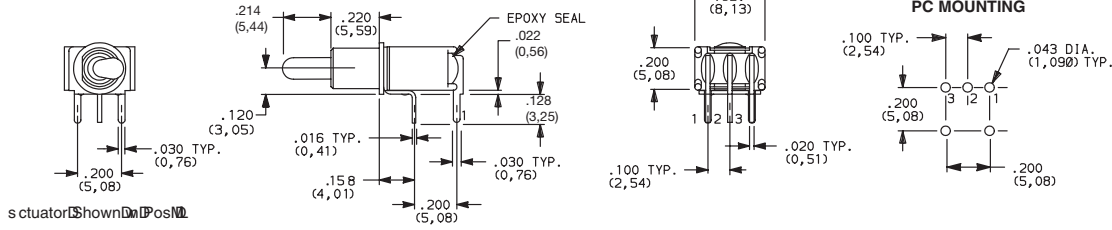

**T101MH9ABE**  
Horizontal Actuation  
**SPDT**

Not available with T102 model.

### A RIGHT ANGLE, PC THRU-HOLE

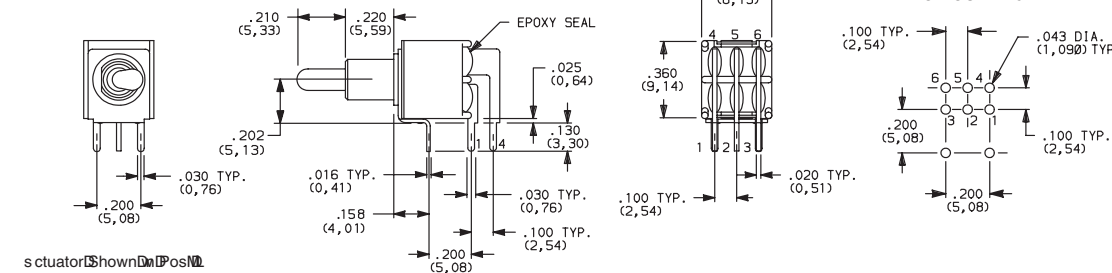

**T201MH9ABE**  
Horizontal Actuation  
**DPDT**

### AV VERTICAL RIGHT ANGLE, PC THRU-HOLE

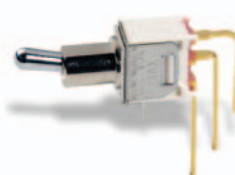
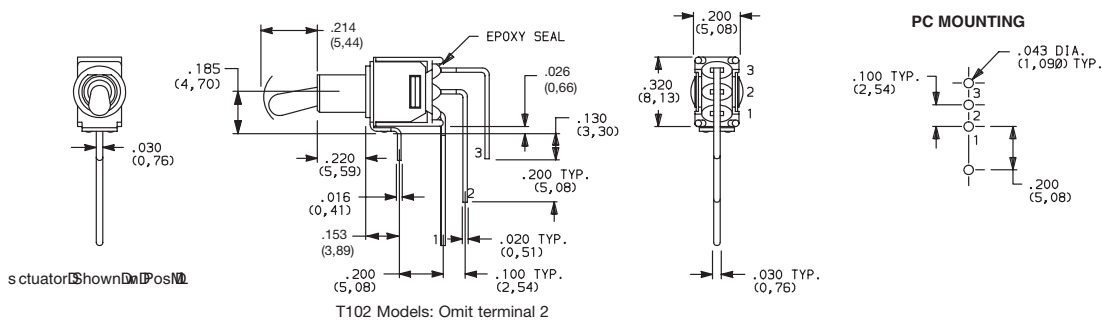

**T101MH9AVBE**  
Vertical Actuation  
**SPDT**

**NOTE:** Terminal bend radii and lead-in manufacturing option.

### AV VERTICAL RIGHT ANGLE, PC THRU-HOLE

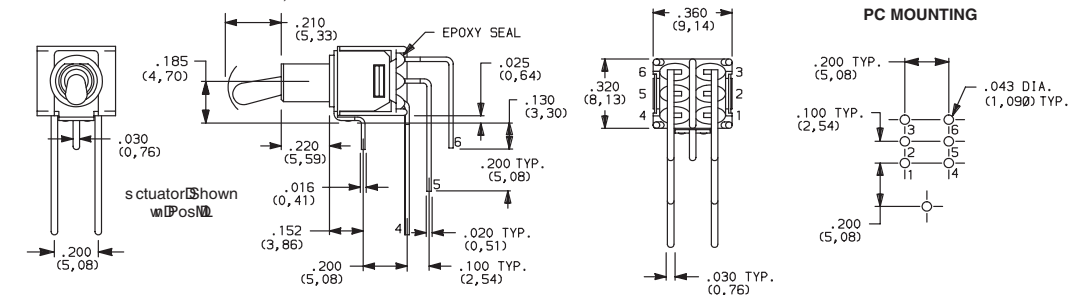

**T201MH9AVBE**  
Vertical Actuation  
**DPDT**

**NOTE:** Terminal bend radii and lead-in manufacturing option.

### V3 VERTICAL MOUNT, V-BRACKET

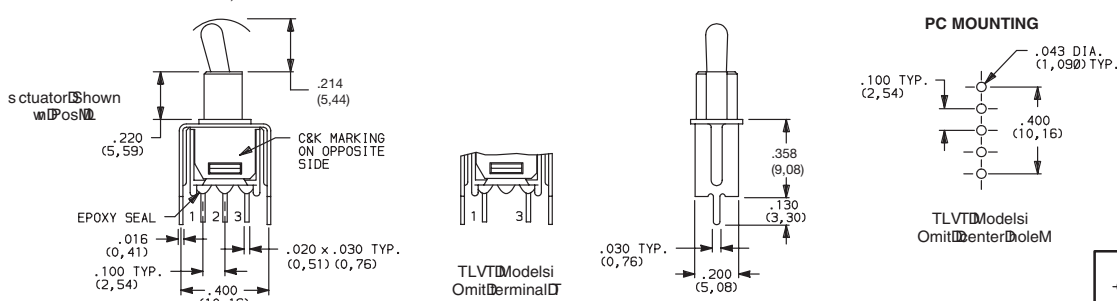

**T101MH9V3BE**  
**SPDT**



Dimensions are shown: Inches (mm)  
Specifications and dimensions subject to change

Toggle Switches



# T Series Subminiature Toggle Switches

## TERMINATIONS

**V3** VERTICAL MOUNT, V-BRACKET



T201MH9V3BE  
DPDT

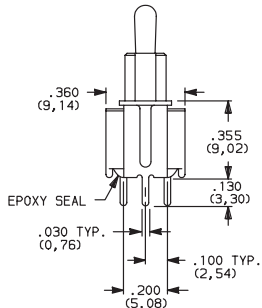
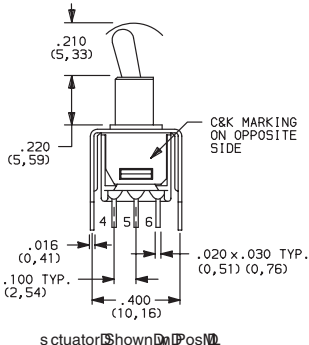

### PC MOUNTING

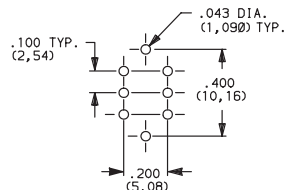

## CONTACT MATERIAL

OPTION CODE	CONTACT MATERIAL	TERMINAL PLATING	RATINGS	
<b>B</b>	GOLD 1	GOLD 1	LOW LEVEL/ DRY CIRCUIT	0.4 VA MAX. @ 20 V AC OR DC MAX.
<b>P</b>		MATTE-TIN 6		
<b>Q</b>	SILVER 4,5	SILVER 5	POWER	TX01 MODELS: 3 AMPS @ 120 V AC OR 28 V DC. ALL OTHER MODELS: 2 AMPS @ 120 V AC OR 28 V DC.
<b>G</b>	GOLD OVER SILVER 2,3	GOLD 3	LOW LEVEL/DRY CIRCUIT OR POWER	TX01 MODELS: 0.4 VA MAX @ 20 V AC OR DC MAX. OR 3 AMPS @ 120 V AC OR 28 V DC. ALL OTHER MODELS: 0.4 VA MAX @ 20 V AC OR DC MAX. OR 2 AMPS @ 120 V AC OR 28 V DC.
<b>R</b>		MATTE-TIN 6		

\* Note: See Technical Data section of this catalog for RoHS compliant and compatible definitions and specifications.

- 1 CONTACTS & TERMINALS: Copper alloy, with gold plate over nickel plate.
- 2 END CONTACTS: Coin silver, with gold plate over nickel plate.
- 3 CENTER CONTACTS & ALL TERMINALS: Copper alloy, with gold plate over nickel plate.
- 4 END CONTACTS: Coin silver, silver plated.
- 5 CENTER CONTACT & ALL TERMINALS: Copper alloy, silver plated.
- 6 TERMINALS: Copper alloy, with matte-tin over nickel plate.

All models with all options when ordered with R, G, or Q contact material.  
B contact material standard with A, AV, V3 & W terminations.  
Q contact material standard with C & Z terminations.

## SEAL

**E** EPOXY SEAL

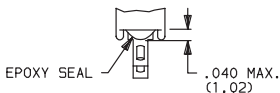

## AVAILABLE HARDWARE

**759D02000** SEALING BOOT



\* Note: For use with S1 actuator style when combined with T, TK, and CF bushings.

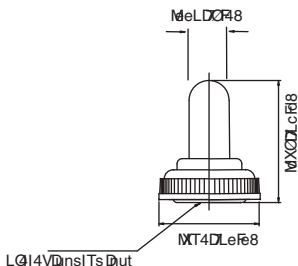

Third Angle  
Projection

Dimensions are shown: Inches (mm)  
Specifications and dimensions subject to change

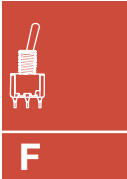

Toggle



# GT Series Sealed Ultraminiature Toggle Switches

## Features/Benefits

- Sealed against solder and cleaning process contaminants
- Ultraminiature size, smallest footprint available
- Thru-hole and surface mount models
- High temperature materials (UL 94V-0)
- RoHS compliant and compatible

## Typical Applications

- Hand-held telecommunications
- Small instrumentation



## Specifications

CONTACT RATING: 0.4 VA max. @ 20 V AC or DC max.  
 MECHANICAL & ELECTRICAL LIFE: 40,000 make-and-break cycles at full load.  
 CONTACT RESISTANCE: Below 50 m Ω typ. initial @ 2-4 V DC, 100 mA.  
 INSULATION RESISTANCE: 10<sup>9</sup> Ω min.  
 DIELECTRIC STRENGTH: 500 Vrms min. @ sea level.  
 OPERATING TEMPERATURE: -30°C to 85°C.  
 SOLDERABILITY: Per MIL-STD-202F method 208D, or EIA RS-186E method 9 (1 hour steam aging).  
 PACKAGING: Surface mount switches shipped in anti-static tape and reel packaging per EIA 481-3, see page F-42 for drawings and reel information. Tape and cover strip are conductive for use near statically sensitive components, consult Customer Service Center.

## Materials

HOUSING AND BASE: Glass filled nylon 4/6, flame retardant, heat stabilized (UL 94V-0).  
 ACTUATOR: Glass filled nylon 4/6, flame retardant, heat stabilized (UL 94V-0), with standard internal o-ring seal.  
 SWITCH SUPPORT: Brass, tin plated.  
 MOVABLE CONTACTS: Copper alloy, with gold plate over nickel plate.  
 STATIONARY CONTACTS: Copper alloy, with gold plate over nickel plate.  
 TERMINALS: Gold.  
 TERMINAL SEAL: Epoxy. All terminals insert molded.

**NOTE:** Specifications and materials listed above are for switches with standard options. For information on specific and custom switches, consult Customer Service Center.

## How To Order

Complete part numbers for GT Series Sealed Ultraminiature Toggle Switches are shown on pages F-38 thru F-42.



GT11MCBE  
SPDT

PART NUMBER	SWITCH FUNCTION		
	POS.1	POS. 2	POS. 3
<b>GT11MCBE</b>	ON	NONE	ON
<b>GT13MCBE</b>	ON	OFF	ON
Conn. Terms.	2-3	OPEN	2-1
Schematic			
SPDT	Note: Pins 4 and 6 not connected		
<b>GT12MCBE</b>	OFF	NONE	ON
Conn. Terms.	OPEN	N/A	3-1
Schematic			
SPST	Note: Pins 4 and 6 not connected		

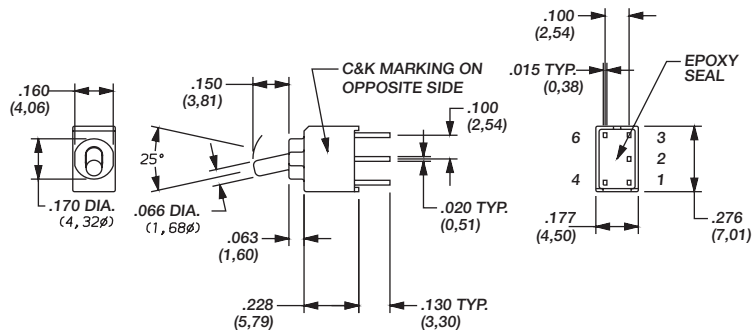

ACTUATOR SHOWN IN POS. 1

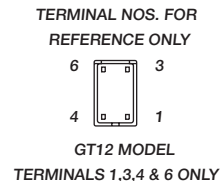
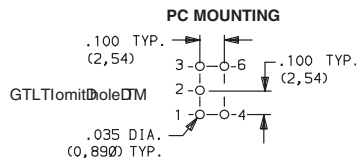

# GT Series Sealed Ultraminiature Toggle Switches

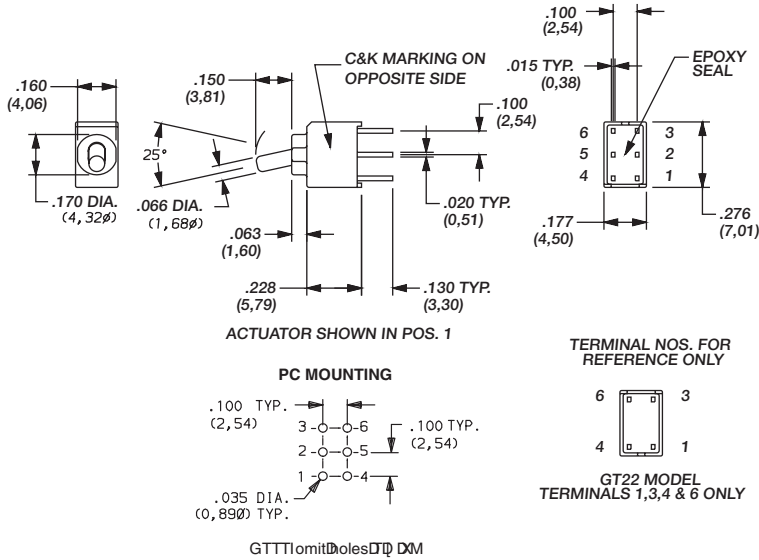

PART NUMBER	SWITCH FUNCTION		
	POS.1	POS. 2	POS. 3
<b>GT21MCBE</b>	ON	NONE	ON
<b>GT23MCBE</b>	ON	OFF	ON
Conn. Terms.	2-3, 5-6	OPEN	2-1, 5-4
Schematic			
DPDT			
<b>GT22MCBE</b>	OFF	NONE	ON
Conn. Terms.	OPEN	N/A	3-1
Schematic			
DPST			

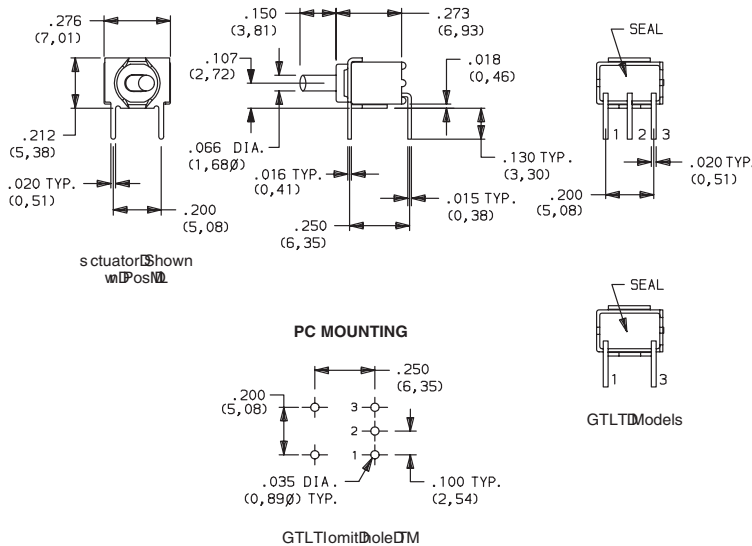

PART NUMBER	SWITCH FUNCTION		
	POS.1	POS. 2	POS. 3
<b>GT11MABE</b>	ON	NONE	ON
<b>GT13MABE</b>	ON	OFF	ON
Conn. Terms.	2-3	OPEN	2-1
Schematic			
SPDT			
<b>GT12MABE</b>	OFF	NONE	ON
Conn. Terms.	OPEN	N/A	3-1
Schematic			
SPST			

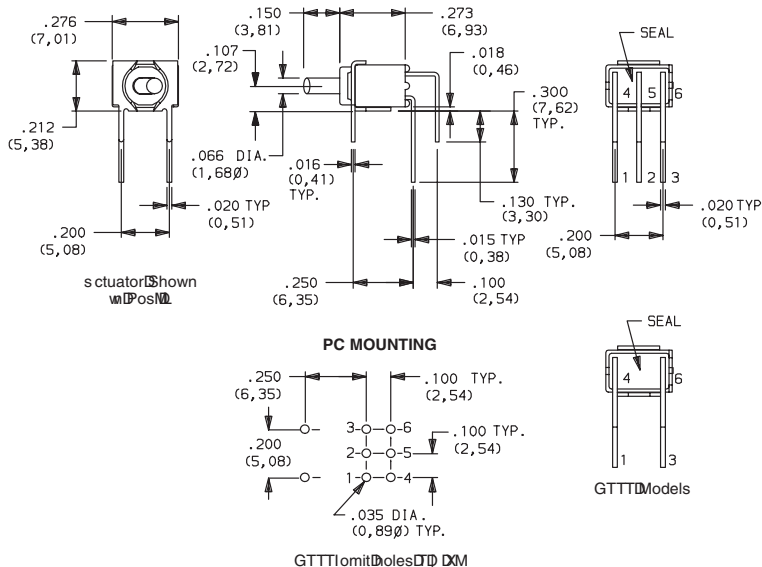

PART NUMBER	SWITCH FUNCTION		
	POS.1	POS. 2	POS. 3
<b>GT21MABE</b>	ON	NONE	ON
<b>GT23MABE</b>	ON	OFF	ON
Conn. Terms.	2-3, 5-6	OPEN	2-1, 5-4
Schematic			
DPDT			
<b>GT22MABE</b>	OFF	NONE	ON
Conn. Terms.	OPEN	N/A	3-1, 6-4
Schematic			
DPST			



*Dimensions are shown: Inches (mm)  
Specifications and dimensions subject to change*



# GT Series Sealed Ultraminiature Toggle Switches



GT11MAVBE  
Vertical  
Actuation  
SPDT

PART NUMBER	SWITCH FUNCTION		
	POS. 1	POS. 2	POS. 3
<b>GT11MAVBE</b> <b>GT13MAVBE</b>	ON	NONE	ON
Conn. Terms.	2-3	OPEN	2-1
Schematic			
SPDT			
<b>GT12MAVBE</b>	OFF	NONE	ON
Conn. Terms.	OPEN	N/A	3-1
Schematic			
SPST			

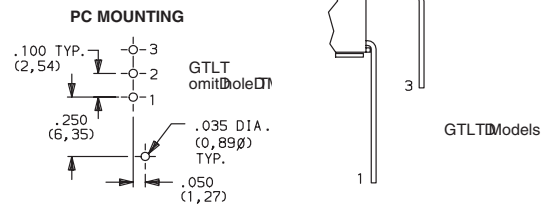
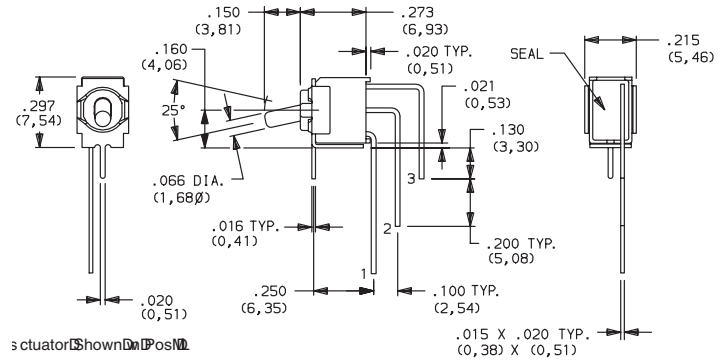

GT21MAVBE  
Vertical  
Actuation  
DPDT

PART NUMBER	SWITCH FUNCTION		
	POS. 1	POS. 2	POS. 3
<b>GT21MAVBE</b> <b>GT23MAVBE</b>	ON	NONE	ON
Conn. Terms.	2-3, 5-6	OPEN	2-1, 5-4
Schematic			
DPDT			
<b>GT22MAVBE</b>	OFF	NONE	ON
Conn. Terms.	OPEN	N/A	3-1, 6-4
Schematic			
DPST			

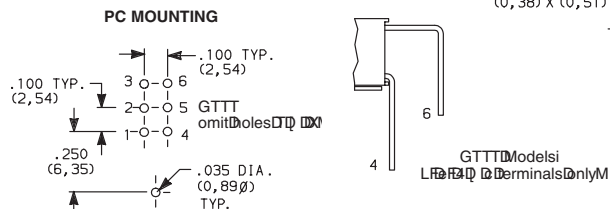
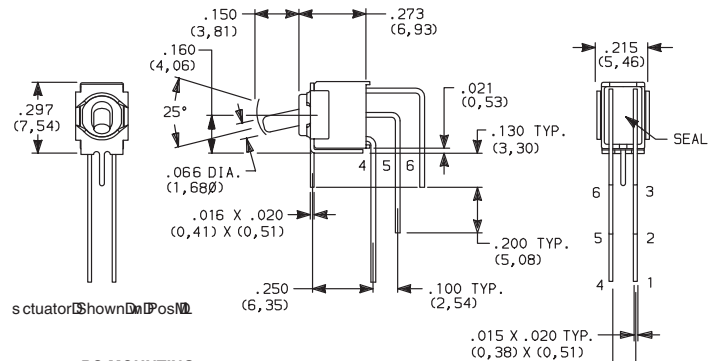

GT11MV3BE  
SPDT

PART NUMBER	SWITCH FUNCTION		
	POS. 1	POS. 2	POS. 3
<b>GT11MV3BE</b> <b>GT13MV3BE</b>	ON	NONE	ON
Conn. Terms.	2-3	OPEN	2-1
Schematic			
SPDT	Note: Pins 4 and 6 not connected		
<b>GT12MV3BE</b>	OFF	NONE	ON
Conn. Terms.	OPEN	N/A	3-1
Schematic			
SPST	Note: Pins 4 and 6 not connected		

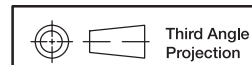
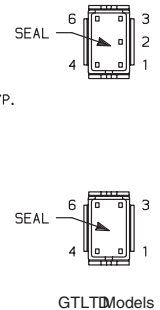
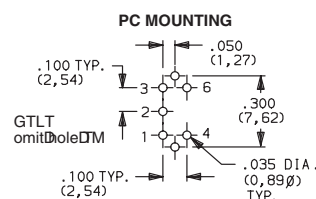
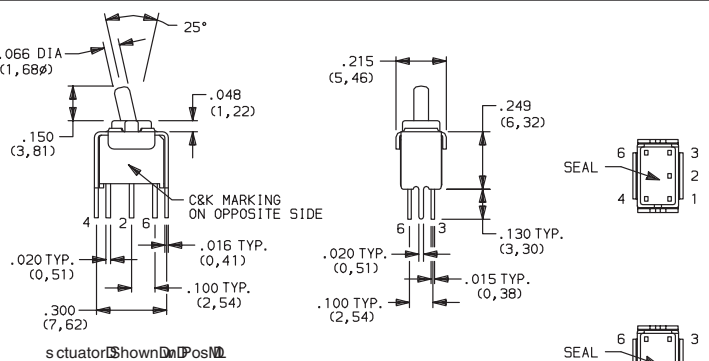

Dimensions are shown: Inches (mm)  
Specifications and dimensions subject to change

Toggle



# GT Series Sealed Ultraminiature Toggle Switches

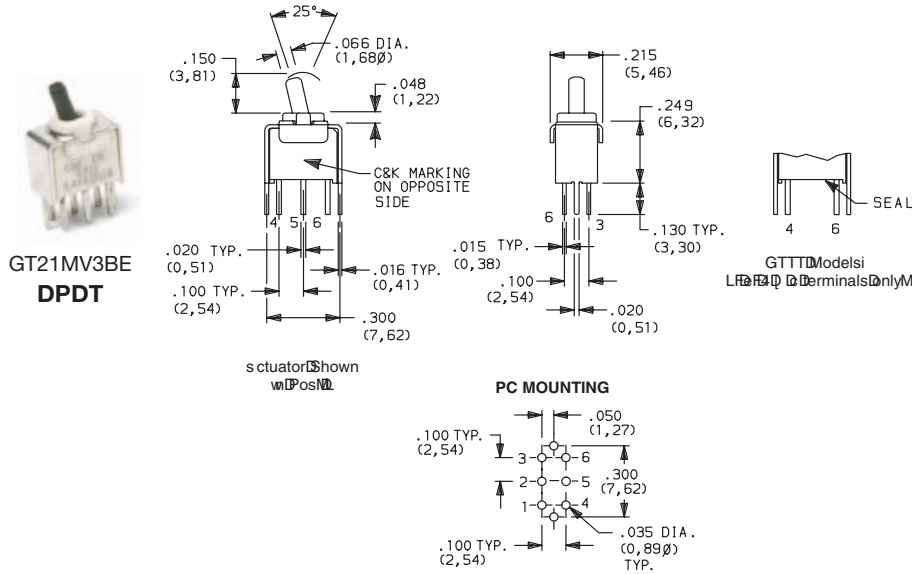

PART NUMBER	SWITCH FUNCTION		
	POS. 1	POS. 2	POS. 3
<b>GT21MV3BE</b> <b>GT23MV3BE</b>	ON	NONE	ON
Conn. Terms.	2-3, 5-6	OPEN	2-1, 5-4
Schematic			
DPDT			
<b>GT22MV3BE</b>	OFF	NONE	ON
Conn. Terms.	OPEN	N/A	3-1, 6-4
Schematic			
DPST			

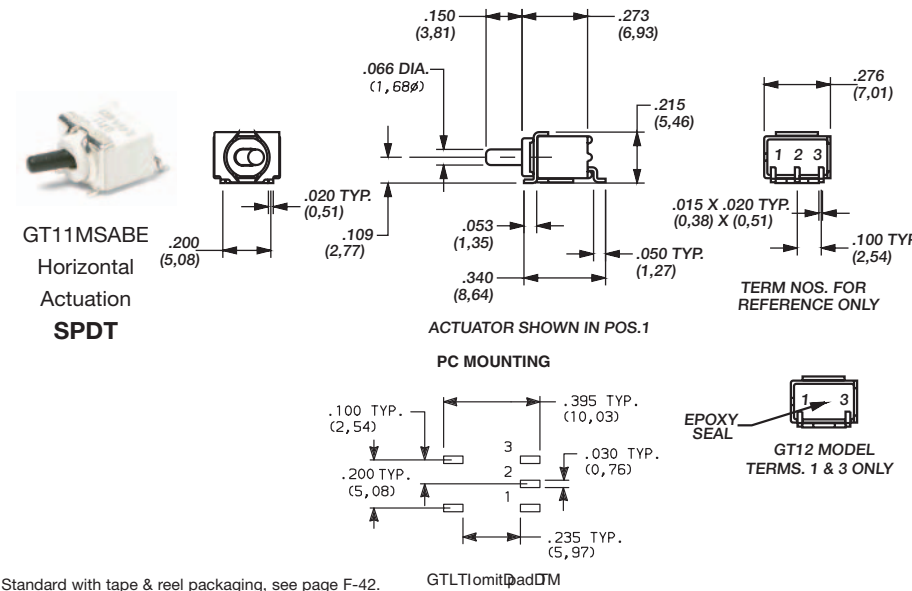

PART NUMBER	SWITCH FUNCTION		
	POS. 1	POS. 2	POS. 3
<b>GT11MSABETR</b> <b>GT13MSABETR</b>	ON	NONE	ON
Conn. Terms.	2-3	OPEN	2-1
Schematic			
SPDT			
<b>GT12MSABETR</b>	OFF	NONE	ON
Conn. Terms.	OPEN	N/A	3-1
Schematic			
SPST			

Standard with tape & reel packaging, see page F-42.

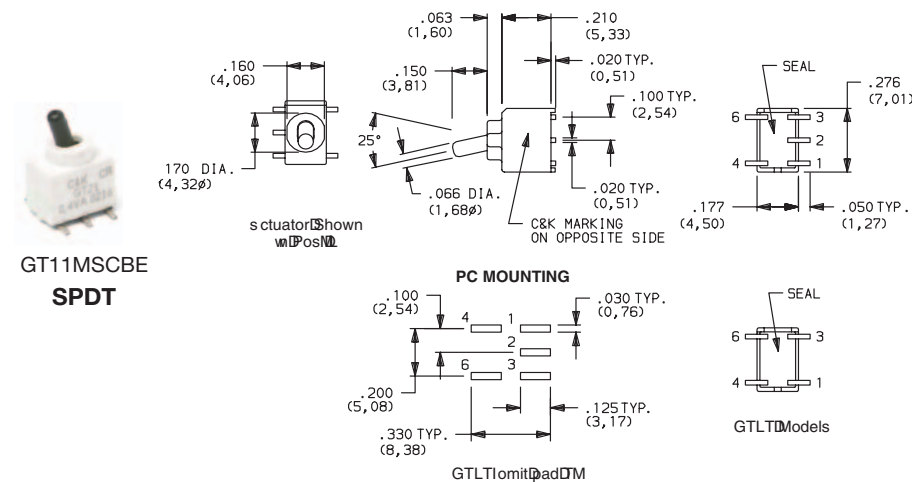

PART NUMBER	SWITCH FUNCTION		
	POS. 1	POS. 2	POS. 3
<b>GT11MSCBETR</b> <b>GT13MSCBETR</b>	ON	NONE	ON
Conn. Terms.	2-3	OPEN	2-1
Schematic			
SPDT			
<b>GT12MSCBETR</b>	OFF	NONE	ON
Conn. Terms.	OPEN	N/A	3-1
Schematic			
SPST			

Standard with tape & reel packaging, see page F-42.



Toggle

# GT Series Sealed Ultraminiature Toggle Switches



GT21MSCBE  
DPDT

PART NUMBER	SWITCH FUNCTION		
	POS. 1	POS. 2	POS. 3
<b>GT21MSCBETR</b>	ON	NONE	ON
<b>GT23MSCBETR</b>	ON	OFF	ON
Conn. Terms.	2-3, 5-6	OPEN	2-1, 5-4
Schematic			
DPDT			
<b>GT22MSCBETR</b>	OFF	NONE	ON
Conn. Terms.	OPEN	N/A	3-1, 6-4
Schematic			
DPST			

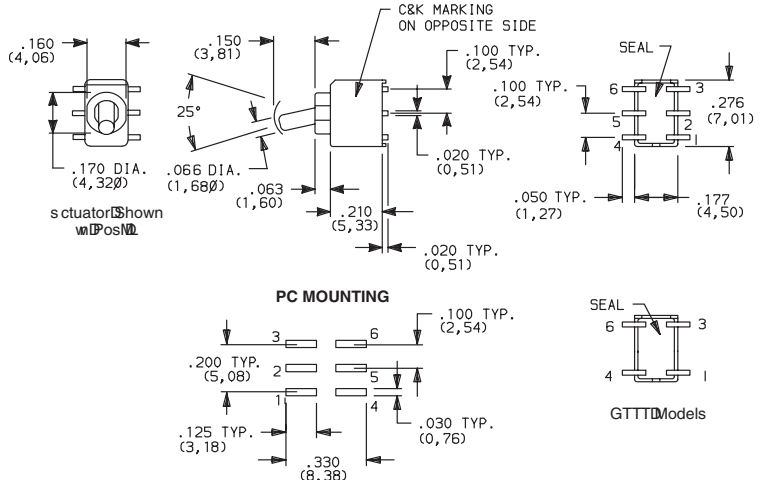

Standard with tape & reel packaging

## TAPE & REEL

For part numbers GT11MSABE, GT12MSABE, GT13MSABE

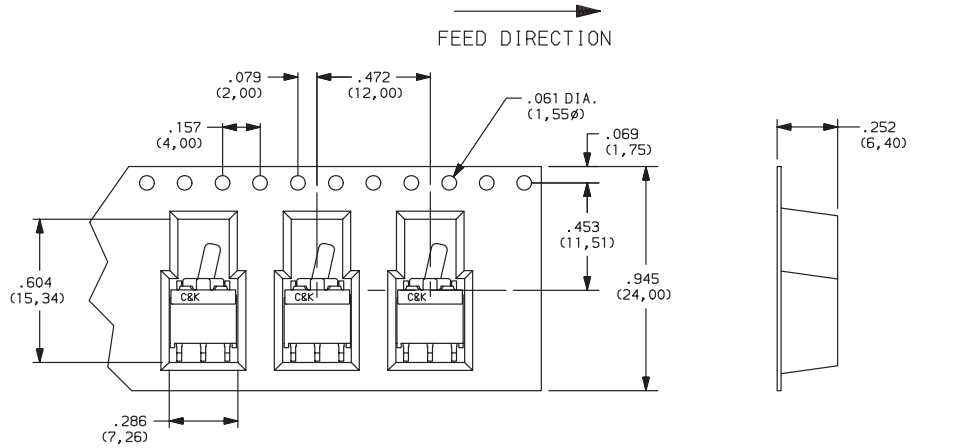

REEL INFORMATION	
OUTSIDE DIAMETER	13.00 (330,0)
PILOT HOLE	.512 (13,0)
QUANTITY PER REEL	600

For part numbers GT11MSCBE, GT12MSCBE, GT13MSCBE, GT21MSCBE, GT22MSCBE, GT23MSCBE,

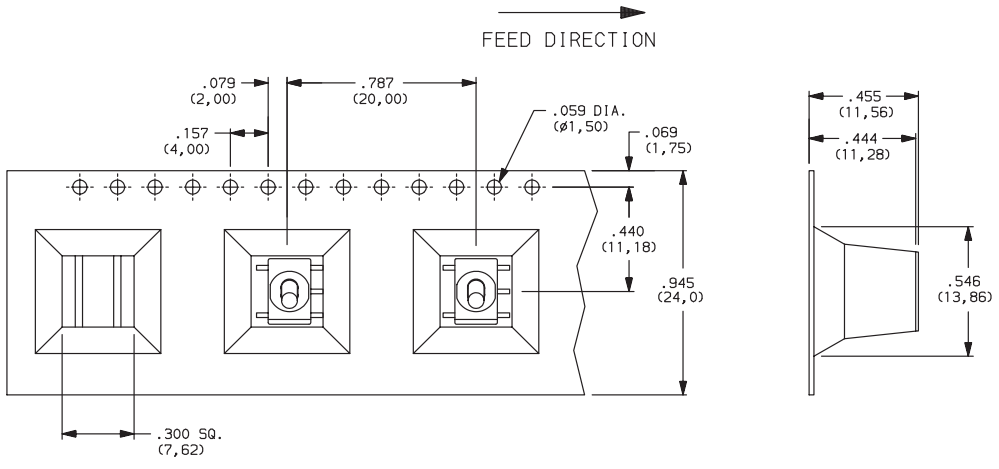

REEL INFORMATION	
OUTSIDE DIAMETER	13.00 (330,0)
PILOT HOLE	.512 (13,0)
QUANTITY PER REEL	200

Toggle F



Dimensions are shown: Inches (mm)  
Specifications and dimensions subject to change

# 9000 Series Power Toggle Switches

## Features/Benefits

- Power ratings up to 10 AMPS
- Double pole models
- Locking lever options available
- Wide variety of actuator styles
- RoHS compliant and compatible

## Typical Applications

- Shut-off switch
- Small equipment

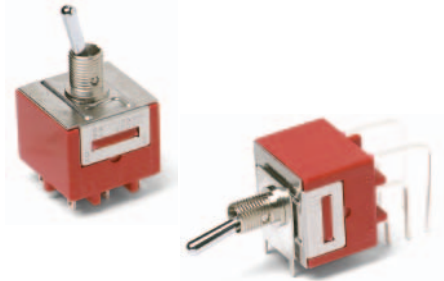

Models Available

## Specifications

CONTACT RATING: 9201 Model: 6 AMPS @ 120 V AC or 28 V DC; 3 AMPS @ 250 V AC. 9221 Model: 10 AMPS @ 125 V AC or 28 V DC; 5 AMPS @ 250 V AC.  
ELECTRICAL LIFE: 25,000 make-and-break cycles at full load.  
CONTACT RESISTANCE: Below 10 m Ω typ. initial @ 2-4 V DC, 100 mA.  
INSULATION RESISTANCE: 10<sup>9</sup> Ω min.  
DIELECTRIC STRENGTH: 2,500 Vrms min. @ sea level.  
OPERATING TEMPERATURE: -30°C to 85°C.  
SOLDERABILITY: Per MIL-STD-202F method 208D, or EIA RS-186E method 9 (1 hour steam aging).

**NOTE:** Any models supplied with Q contact material are RoHS compliant and compatible.

**NOTE:** Specifications and materials listed above are for switches with standard options. For information on specific and custom switches, consult Customer Service Center.

## Materials

CASE: Diallyl phthalate (DAP) (UL 94V-0).  
ACTUATOR: Brass, chrome plated.  
BUSHING: Brass or zinc, nickel plated.  
HOUSING: Stainless steel.  
SWITCH SUPPORT: Brass or steel, matte-tin plated.  
END CONTACTS: 9201 Model: Coin silver, silver plated. 9221 Model: Silver cadmium oxide.  
CENTER CONTACTS: Copper alloy, silver plated  
ALL TERMINALS: 9201 Model: Copper alloy, silver plated. 9221 Model: Copper alloy, matte-tin plated.  
TERMINAL SEAL: Epoxy.  
HARDWARE: Nut & Locking ring: Brass, nickel plated. Lockwasher: Steel, nickel plated.

## Build-A-Switch

To order, simply select desired option from each category and place in the appropriate box. Available options are shown and described on pages F-43 thru F-47. For additional options not shown in catalog, consult Customer Service Center.

<p><b>Switch Function</b></p> <p><b>9201</b> DPDT, On-On, 6 Amps <b>9221</b> DPDT, On-On, 10 Amps</p> <p><b>Actuator</b></p> <p><b>S</b> Antirotation, .410" high <b>K</b> Locking lever, .650" high <b>K1</b> Locking lever, .680" high <b>L43</b> Lever handle with cap <b>P3</b> Flatted, anti-rotation, .450" high <b>T</b> .687" high, 15/32 bushing <b>T1</b> .460" high, 15/32 bushing</p> <p><b>Bushing</b></p> <p><b>H3</b> .296" high, keyway <b>CW</b> Splashproof <b>H</b> .296" high, flat</p> <p><b>Terminations</b></p> <p><b>Z</b> Solder lug <b>Z4</b> Quick connect (9221 only) <b>AV2</b> Vert. right angle, PC thru-hole (9201 only) <b>C</b> PC Thru-hole</p> <p><b>Contact Material</b></p> <p><b>Q</b> Silver</p> <p><b>Seal</b></p> <p><b>E</b> Epoxy <b>D</b> No epoxy</p> <p><b>Actuator Color/Finish</b></p> <p><b>NONE</b> Bright chrome <b>2</b> Black</p> <p><b>Bushing Finish</b></p> <p><b>NONE</b> Nickel <b>2</b> Black</p> <p><b>KXX Actuator Color/Finish</b></p> <p><b>NONE</b> Natural aluminum <b>2</b> Black anodized aluminum</p>	<p><b>Build-A-Switch Diagram:</b></p>
--	---------------------------------------



Dimensions are shown: Inches (mm)  
Specifications and dimensions subject to change

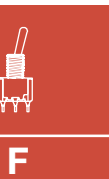

# 9000 Series Power Toggle Switches

## SWITCH FUNCTION

NO. POLES	MODEL NO.	RATING*	SWITCH FUNCTION		CONNECTED TERMINALS		SCHEMATIC
			POS. 1 KEYWAY	POS. 2 KEYWAY	POS. 1 KEYWAY	POS. 2 KEYWAY	
DP	9201	6 AMPS	ON	ON	2-3,5-6	2-1,5-4	
	9221	10 AMPS	ON	ON			

**DPDT**

Part number shown: 9201SH3ZQE

Terminal Nos. Molded On Side Of Case

\* See CONTACT MATERIAL, page F-47, for complete ratings.

All 9000 Series models meet international dimensional and electrical requirements.

9221 model must be ordered with Z4 terminations and D seal option.

## ACTUATOR

**S** ANTIROTATION, .410" HIGH

**P3** FLATTED, ANTIROTATION, .450" HIGH

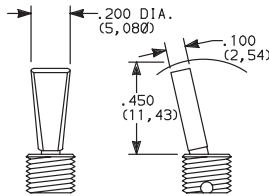
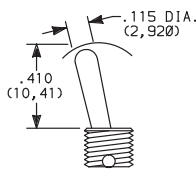

OPTION CODE	ACTUATOR FINISH
<b>NONE</b>	NATURAL ALUMINUM—With Nickel Plated Bushing
<b>2</b>	BLACK

**NOTE:** Black hardware is supplied when either black actuators or bushings are specified. All hardware is available separately, see Section N.

Antirotation is standard on all actuators, provides 'anti-push-in' feature on actuator.

Dress nut part number: 709901201 supplied standard with P3 actuator.

**T** .687" HIGH, 15/32 BUSHING

**T1** .460" HIGH, 15/32 BUSHING

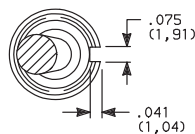
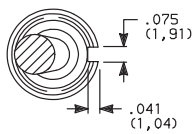

OPTION CODE	ACTUATOR FINISH
<b>NONE</b>	BRIGHT CHROME—With Nickel Plated Bushing
<b>2</b>	BLACK

**NOTE:** Bushing option code not required for T & T1 actuators unless CW splashproof bushing ordered.

Black hardware is supplied when either black actuators or bushings are specified. All hardware is available separately, see Section N.

Antirotation is standard on all actuators except T & T1, provides 'anti-push-in' feature on actuator.



Dimensions are shown: Inches (mm)  
Specifications and dimensions subject to change



Toggle





# 9000 Series Power Toggle Switches

## ACTUATOR ACTUATOR FINISH

**K** LOCKING LEVER, .650" HIGH, THREADED

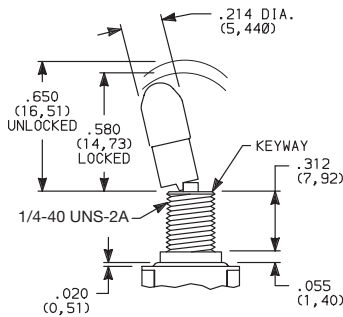

**K1** LOCKING LEVER, .680" HIGH, THREADED

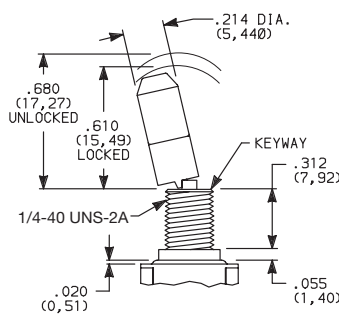

### Locking Positions



TPositionLock

**NOTE:** To prevent accidental actuation, toggles must be lifted before being actuated. When released, toggles again lock in place. Bushing option code not required. Overtightening mounting nut may cause actuator to bind.

OPTION CODE	ACTUATOR CAP FINISH
<b>NONE</b>	NATURAL ALUMINUM—With Nickel Plated Bushing
<b>2</b>	BLACK ANODIZED ALUMINUM

**L40** LEVER HANDLE WITHOUT CAP

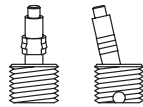

No color choice required.

**L43** PLASTIC LEVER HANDLE WITH ANTIROTATION AND CAP, P/N 4812

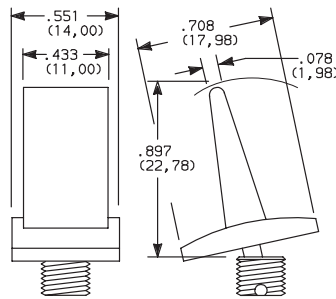

Finish: Matte

OPTION CODE	ACTUATOR CAP COLOR
<b>2</b>	BLACK
<b>NONE</b>	No Actuator Color (L40 option)

Other colors available, consult Customer Service Center.

**NOTE:** Lever handle actuator L43 supplied, but not installed. For interchangeability, order L40 actuator option and order lever handles separately, see page F-47. Antirotation is standard on all actuators, provides 'anti-push-in' feature.

## BUSHING BUSHING FINISH

**H3** .296" HIGH, THREADED, KEYWAY

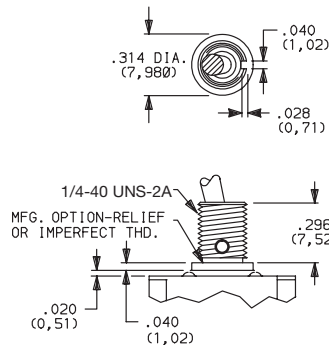

**H** .296" HIGH, THREADED, FLAT

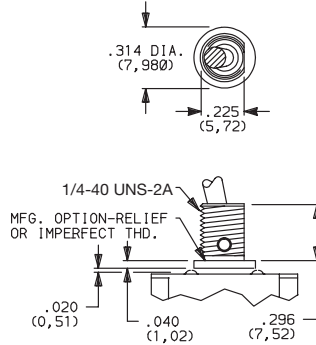

**CW** SPLASHPROOF, 15/32 BUSHING

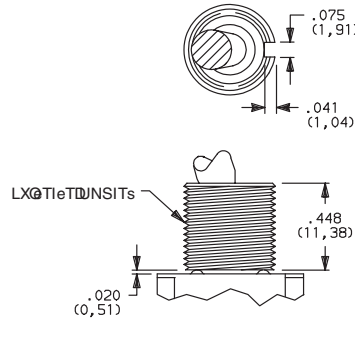

Will withstand 12 in./lbs. of torque with no distortion.

For T & T1 actuators only.

**NOTE:** Two mounting nuts, locking ring and lockwasher supplied standard with threaded bushings. Black hardware is supplied when either black bushings or actuators are specified. Optional mounting nut and locking ring styles and finishes available, see Section N.

Internal actuator seal standard. External bushing seal available separately from APM Hexseal, part # MFS-60064.

OPTION CODE	BUSHING FINISH
<b>NONE</b>	NICKEL
<b>2</b>	BLACK

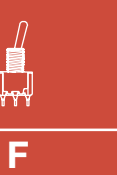

**F**

Toggle

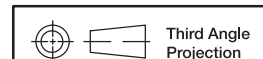

Third Angle Projection  
Dimensions are shown: Inches (mm)  
Specifications and dimensions subject to change



# 9000 Series Power Toggle Switches

## BUSHING

### PANEL MOUNTING

1/4-40 UNS-2A

15/32-32 UNS-2A

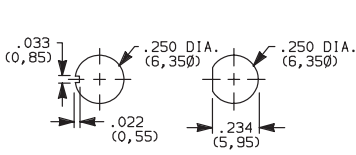

Without Docking Ring M

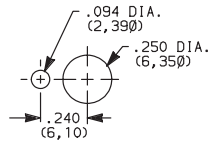

With Standard Docking Ring M

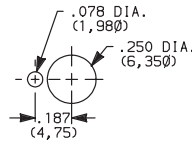

With Small Docking Ring M

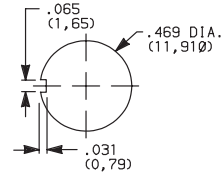

Without Docking Ring M

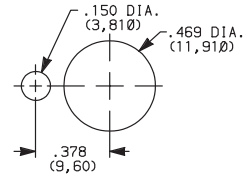

With Standard Docking Ring M

## TERMINATIONS

### Z SOLDER LUG

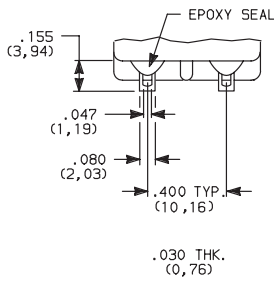

9201 Only

### C PC THRU-HOLE

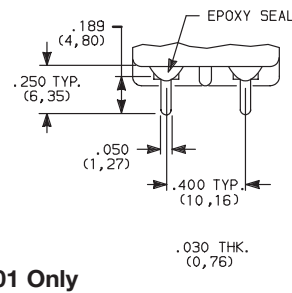

9201 Only

### PC MOUNTING

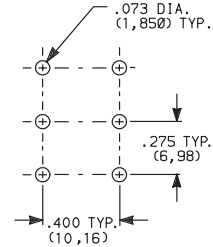

### Z4 .187" QUICK CONNECT

9221 Only

**NOTE:** Only termination available with 9221 model. Must be ordered with D seal option. Mates with standard .187 Nema female connector.

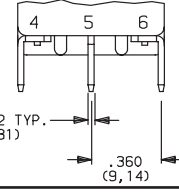
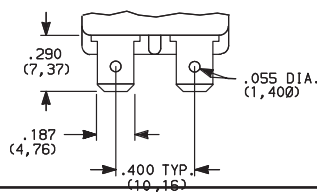

### AV2 VERTICAL RIGHT ANGLE, PC THRU-HOLE

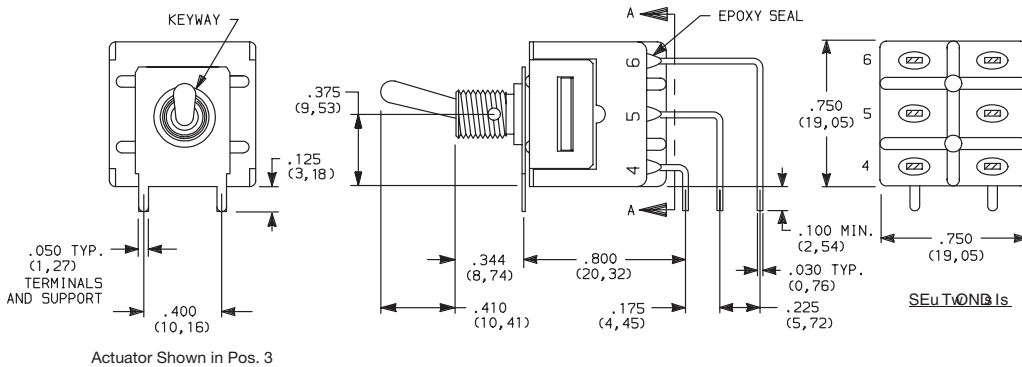

Actuator Shown in Pos. 3



9201SH3AV2QE  
Vertical Actuation  
DPDT

### PC MOUNTING

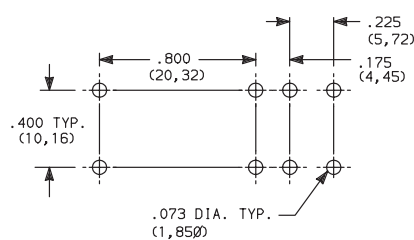

Terminal Nos.  
For Reference Only



Third Angle  
Projection

Dimensions are shown: Inches (mm)  
Specifications and dimensions subject to change

www.ck-components.com

9201 Only

**NOTE:** Terminal bend radii and lead-in manufacturing option. Terminal spacing greater than 3mm at all points.



# 9000 Series Power Toggle Switches

## CONTACT MATERIAL

OPTION CODE	MODEL	CONTACT MATERIAL	TERMINAL PLATING	RATINGS	
Q	9201	SILVER <sup>1,2</sup>	SILVER OR TIN <sup>2,5</sup>	POWER	6 AMPS @120 V AC OR 28 V DC; 3 AMPS @ 250 V AC.
	9221	SILVER CADMIUM OXIDE <sup>3,4,6</sup>	TIN <sup>5</sup>		10 AMPS @125 V AC OR 28 V DC; 5 AMPS @ 250 V AC.

\* Note: See Technical Data section of this catalog for RoHS compliant and compatible definitions and specifications.

<sup>1</sup> END CONTACTS: Coin silver, silver plated.

<sup>2</sup> CENTER CONTACTS & ALL TERMINALS: Copper alloy, silver plated.

<sup>3</sup> END CONTACTS: Silver cadmium oxide.

<sup>4</sup> CENTER CONTACTS: Copper alloy, silver plated.

<sup>5</sup> Z4 TERMINALS ONLY: Copper alloy, matte-tin plated.

<sup>6</sup> Cadmium in electrical switch contacts is exempt from RoHS.

**NOTE:** Any models supplied with Q contact material are RoHS compliant.

All 9000 Series models meet international dimensional and electrical requirements. 

9221 model must be ordered with Z4 terminations and D seal option.

## SEAL

**E** EPOXY SEAL

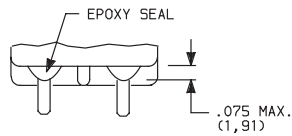

Not available with 9221 model or Z4 terminations.

**D** NO EPOXY SEAL

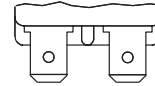

Must be ordered with 9221 model and Z4 termination.

## AVAILABLE HARDWARE

Cap  
Compatible with S actuator



**PART NO.**  
**896801000** WHITE  
**896802000** BLACK  
**896803000** RED  
 Material: Polyethylene  
 Finish: Matte

Cap  
Compatible with S actuator



**PART NO.**  
**706201000** WHITE  
**706202000** BLACK  
**706203000** RED  
 Material: Vinyl  
 Finish: Matte

L43 Actuator

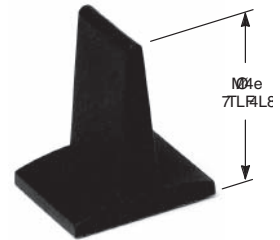

**PART NO.**  
**481202000** BLACK  
**481203000** RED  
 Material: Nylon  
 Finish: Matte

**NOTE:** Additional nuts, locking rings and lockwashers available separately, see Section N.

Other colors available, consult Customer Service Center.

759D02000 Sealing Boot

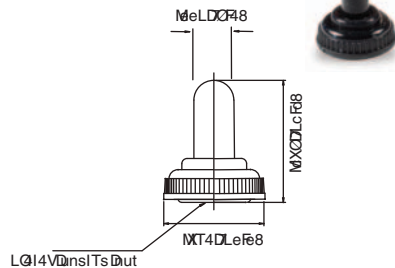

**NOTE:** For use with S actuator style when combined with H3 and H bushings

703D02000 Sealing Boot

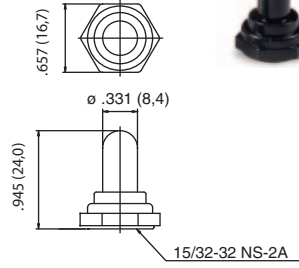

**NOTE:** For use with T style actuator

704D02000 Sealing Boot

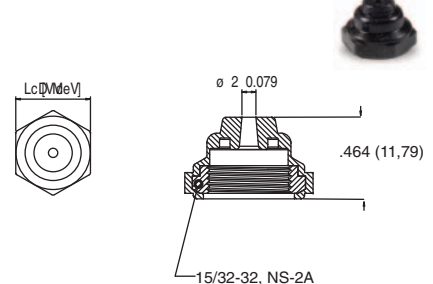

**NOTE:** For use with T style actuator

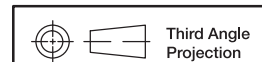

Third Angle Projection  
 Dimensions are shown: Inches (mm)  
 Specifications and dimensions subject to change



Компания «ЭлектроПласт» предлагает заключение долгосрочных отношений при поставках импортных электронных компонентов на взаимовыгодных условиях!

Наши преимущества:

- Оперативные поставки широкого спектра электронных компонентов отечественного и импортного производства напрямую от производителей и с крупнейших мировых складов;
- Поставка более 17-ти миллионов наименований электронных компонентов;
- Поставка сложных, дефицитных, либо снятых с производства позиций;
- Оперативные сроки поставки под заказ (от 5 рабочих дней);
- Экспресс доставка в любую точку России;
- Техническая поддержка проекта, помощь в подборе аналогов, поставка прототипов;
- Система менеджмента качества сертифицирована по Международному стандарту ISO 9001;
- Лицензия ФСБ на осуществление работ с использованием сведений, составляющих государственную тайну;
- Поставка специализированных компонентов (Xilinx, Altera, Analog Devices, Intersil, Interpoint, Microsemi, Aeroflex, Peregrine, Syfer, Eurofarad, Texas Instrument, Miteq, Cobham, E2V, MA-COM, Hittite, Mini-Circuits, General Dynamics и др.);

Помимо этого, одним из направлений компании «ЭлектроПласт» является направление «Источники питания». Мы предлагаем Вам помощь Конструкторского отдела:

- Подбор оптимального решения, техническое обоснование при выборе компонента;
- Подбор аналогов;
- Консультации по применению компонента;
- Поставка образцов и прототипов;
- Техническая поддержка проекта;
- Защита от снятия компонента с производства.



#### Как с нами связаться

**Телефон:** 8 (812) 309 58 32 (многоканальный)

**Факс:** 8 (812) 320-02-42

**Электронная почта:** [org@eplast1.ru](mailto:org@eplast1.ru)

**Адрес:** 198099, г. Санкт-Петербург, ул. Калинина, дом 2, корпус 4, литера А.