

# Illuminated Tactile Switches

## B3W-9

### Compact Illuminated Tactile Switch with 2 LEDs

- Compact construction (10 x 10 mm and 12 x 12 mm with 11 mm height) with bright and uniform illumination.
- Three-color illumination (red LED + green LED = orange).
- Standard force (160 gf) and high-force (230 gf) models.
- RoHS Compliant



**NEW**

## Features

#### Bright and uniform illumination

- Compact construction 10 × 10 × 11 mm (W × D × H) and 12 × 12 × 11 mm (W × D × H) equipped with 2 LEDs.
- Uniquely constructed diffusion panel.

#### Three-color illumination

- Simultaneous use of red and green LEDs create a third color (orange).



#### Snap-action contact construction for a positive click action.

- Models available with two different operating forces, standard force (160 gf) and high-force (230 gf).

#### High contact reliability

- Sealed construction provides high contact reliability.

## Model Number Structure

B3W-90□□-□□□□  
1 2 3 4 5

#### 1. Cap width

- 0: 10 x 10 mm
- 1: 12 x 12 mm

#### 2. Operating force

- 0: Standard (OF = 160 gf)
- 2: High-force (OF = 230 gf)

#### 3. LED color

- R: Red
- G: Green
- HG: Green (high brightness)
- Y: Yellow
- B: Blue
- RG: Red + Green (Combination of LED colors)
- RB: Red + Blue (Combination of LED colors)

#### 4. No. of LEDs

- 1: 1
- 2: 2

#### 5. Cap

- R: Red
- G: Green
- Y: Yellow
- B: Blue
- C: Transparent
- N: Milky white

- Note:**
1. Switches with two LEDs are only available with Transparent or Milky White caps.
  2. If a tricolour operation is required, use the Red+Green (RG) combination with the milky white cap. Simultaneous illumination of these two LEDs will produce Orange.

# Ordering Information

## ■ 10 x 10 mm Switches

### Standard force

| Force                           | LED Colour                 | No. of LEDs | Cap color             | Model                |
|---------------------------------|----------------------------|-------------|-----------------------|----------------------|
| Standard force<br>(OF = 160 gf) | Blue                       | 1           | Blue                  | <b>B3W-9000-B1B</b>  |
|                                 |                            |             | Transparent           | <b>B3W-9000-B1C</b>  |
|                                 |                            |             | Milky white           | <b>B3W-9000-B1N</b>  |
|                                 |                            | 2           | Blue                  | <b>B3W-9000-B2B</b>  |
|                                 |                            |             | Transparent           | <b>B3W-9000-B2C</b>  |
|                                 |                            |             | Milky white           | <b>B3W-9000-B2N</b>  |
|                                 | Green                      | 1           | Green                 | <b>B3W-9000-G1G</b>  |
|                                 |                            |             | Transparent           | <b>B3W-9000-G1C</b>  |
|                                 |                            |             | Milky white           | <b>B3W-9000-G1N</b>  |
|                                 |                            | 2           | Green                 | <b>B3W-9000-G2G</b>  |
|                                 |                            |             | Transparent           | <b>B3W-9000-G2C</b>  |
|                                 |                            |             | Milky white           | <b>B3W-9000-G2N</b>  |
|                                 | Green<br>(High brightness) | 1           | Green                 | <b>B3W-9000-HG1G</b> |
|                                 |                            |             | Transparent           | <b>B3W-9000-HG1C</b> |
|                                 |                            |             | Milky white           | <b>B3W-9000-HG1N</b> |
|                                 |                            | 2           | Green                 | <b>B3W-9000-HG2G</b> |
|                                 |                            |             | Transparent           | <b>B3W-9000-HG2C</b> |
|                                 |                            |             | Milky white           | <b>B3W-9000-HG2N</b> |
|                                 | Red                        | 1           | Red                   | <b>B3W-9000-R1R</b>  |
|                                 |                            |             | Transparent           | <b>B3W-9000-R1C</b>  |
|                                 |                            |             | Milky white           | <b>B3W-9000-R1N</b>  |
|                                 |                            | 2           | Red                   | <b>B3W-9000-R2R</b>  |
|                                 |                            |             | Transparent           | <b>B3W-9000-R2C</b>  |
|                                 |                            |             | Milky white           | <b>B3W-9000-R2N</b>  |
| Yellow                          | 1                          | Yellow      | <b>B3W-9000-Y1Y</b>   |                      |
|                                 |                            | Transparent | <b>B3W-9000-Y1C</b>   |                      |
|                                 |                            | Milky white | <b>B3W-9000-Y1N</b>   |                      |
|                                 | 2                          | Yellow      | <b>B3W-9000-Y2Y</b>   |                      |
|                                 |                            | Transparent | <b>B3W-9000-Y2C</b>   |                      |
|                                 |                            | Milky white | <b>B3W-9000-Y2N</b>   |                      |
| Red + Blue                      | 2                          | Transparent | <b>B3W-9000-RB2C</b>  |                      |
| Red+<br>Green                   | 2                          | Transparent | <b>B3W-9000-RG2C</b>  |                      |
|                                 |                            | Milky white | <b>B3W-9000-RG2N</b>  |                      |
| Red+High<br>Brightness<br>Green | 2                          | Transparent | <b>B3W-9000-RHG2C</b> |                      |

### High-force

| Force                           | LED Colour                 | No. of LEDs | Cap color             | Model                |
|---------------------------------|----------------------------|-------------|-----------------------|----------------------|
| High-force<br>(OF = 230 gf)     | Blue                       | 1           | Blue                  | <b>B3W-9002-B1B</b>  |
|                                 |                            |             | Transparent           | <b>B3W-9002-B1C</b>  |
|                                 |                            |             | Milky white           | <b>B3W-9002-B1N</b>  |
|                                 |                            | 2           | Blue                  | <b>B3W-9002-B2B</b>  |
|                                 |                            |             | Transparent           | <b>B3W-9002-B2C</b>  |
|                                 |                            |             | Milky white           | <b>B3W-9002-B2N</b>  |
|                                 | Green                      | 1           | Green                 | <b>B3W-9002-G1G</b>  |
|                                 |                            |             | Transparent           | <b>B3W-9002-G1C</b>  |
|                                 |                            |             | Milky white           | <b>B3W-9002-G1N</b>  |
|                                 |                            | 2           | Green                 | <b>B3W-9002-G2G</b>  |
|                                 |                            |             | Transparent           | <b>B3W-9002-G2C</b>  |
|                                 |                            |             | Milky white           | <b>B3W-9002-G2N</b>  |
|                                 | Green<br>(High brightness) | 1           | Green                 | <b>B3W-9002-HG1G</b> |
|                                 |                            |             | Transparent           | <b>B3W-9002-HG1C</b> |
|                                 |                            |             | Milky white           | <b>B3W-9002-HG1N</b> |
|                                 |                            | 2           | Green                 | <b>B3W-9002-HG2G</b> |
|                                 |                            |             | Transparent           | <b>B3W-9002-HG2C</b> |
|                                 |                            |             | Milky white           | <b>B3W-9002-HG2N</b> |
|                                 | Red                        | 1           | Red                   | <b>B3W-9002-R1R</b>  |
|                                 |                            |             | Transparent           | <b>B3W-9002-R1C</b>  |
|                                 |                            |             | Milky white           | <b>B3W-9002-R1N</b>  |
|                                 |                            | 2           | Red                   | <b>B3W-9002-R2R</b>  |
|                                 |                            |             | Transparent           | <b>B3W-9002-R2C</b>  |
|                                 |                            |             | Milky white           | <b>B3W-9002-R2N</b>  |
| Yellow                          | 1                          | Yellow      | <b>B3W-9002-Y1Y</b>   |                      |
|                                 |                            | Transparent | <b>B3W-9002-Y1C</b>   |                      |
|                                 |                            | Milky white | <b>B3W-9002-Y1N</b>   |                      |
|                                 | 2                          | Yellow      | <b>B3W-9002-Y2Y</b>   |                      |
|                                 |                            | Transparent | <b>B3W-9002-Y2C</b>   |                      |
|                                 |                            | Milky white | <b>B3W-9002-Y2N</b>   |                      |
| Red + Blue                      | 2                          | Transparent | <b>B3W-9002-RB2C</b>  |                      |
| Red +<br>Green                  | 2                          | Transparent | <b>B3W-9002-RG2C</b>  |                      |
|                                 |                            | Milky white | <b>B3W-9002-RG2N</b>  |                      |
| Red+High<br>Brightness<br>Green | 2                          | Transparent | <b>B3W-9000-RHG2C</b> |                      |

## ■ 12 × 12-mm Switches

### Standard force

| Force                           | LED Colour                 | No. of LEDs | Cap color   | Model          |
|---------------------------------|----------------------------|-------------|-------------|----------------|
| Standard force<br>(OF = 160 gf) | Blue                       | 1           | Blue        | B3W-9010-B1B   |
|                                 |                            | 1           | Milky white | B3W-9010-B1N   |
|                                 |                            | 2           | Blue        | B3W-9010-B2B   |
|                                 |                            | 2           | Milky white | B3W-9010-B2N   |
|                                 | Green                      | 1           | Green       | B3W-9010-G1G   |
|                                 |                            | 1           | Milky white | B3W-9010-G1N   |
|                                 |                            | 2           | Green       | B3W-9010-G2G   |
|                                 |                            | 2           | Milky white | B3W-9010-G2N   |
|                                 | Green<br>(High brightness) | 1           | Green       | B3W-9010-HG1G  |
|                                 |                            | 1           | Milky white | B3W-9010-HG1N  |
|                                 |                            | 2           | Green       | B3W-9010-HG2G  |
|                                 |                            | 2           | Milky white | B3W-9010-HG2N  |
|                                 | Red                        | 1           | Red         | B3W-9010-R1R   |
|                                 |                            | 1           | Milky white | B3W-9010-R1N   |
|                                 |                            | 2           | Red         | B3W-9010-R2R   |
|                                 |                            | 2           | Milky white | B3W-9010-R2N   |
|                                 | Yellow                     | 1           | Yellow      | B3W-9010-Y1Y   |
|                                 |                            | 1           | Milky white | B3W-9010-Y1N   |
|                                 |                            | 2           | Yellow      | B3W-9010-Y2Y   |
|                                 |                            | 2           | Milky white | B3W-9010-Y2N   |
|                                 | Red+Blue                   | 2           | Milky white | B3W-9010-RB2N  |
|                                 | Red+Green                  | 2           | Milky white | B3W-9010-RG2N  |
|                                 | Red+High Brightness Green  | 2           | Milky white | B3W-9010-RHG2N |

### High-force

| Force                       | LED Colour                 | No. of LEDs | Cap color   | Model          |
|-----------------------------|----------------------------|-------------|-------------|----------------|
| High-force<br>(OF = 230 gf) | Blue                       | 1           | Blue        | B3W-9012-B1B   |
|                             |                            | 1           | Milky white | B3W-9012-B1N   |
|                             |                            | 2           | Blue        | B3W-9012-B2B   |
|                             |                            | 2           | Milky white | B3W-9012-B2N   |
|                             | Green                      | 1           | Green       | B3W-9012-G1G   |
|                             |                            | 1           | Milky white | B3W-9012-G1N   |
|                             |                            | 2           | Green       | B3W-9012-G2G   |
|                             |                            | 2           | Milky white | B3W-9012-G2N   |
|                             | Green<br>(High brightness) | 1           | Green       | B3W-9012-HG1G  |
|                             |                            | 1           | Milky white | B3W-9012-HG1N  |
|                             |                            | 2           | Green       | B3W-9012-HG2G  |
|                             |                            | 2           | Milky white | B3W-9012-HG2N  |
|                             | Red                        | 1           | Red         | B3W-9012-R1R   |
|                             |                            | 1           | Milky white | B3W-9012-R1N   |
|                             |                            | 2           | Red         | B3W-9012-R2R   |
|                             |                            | 2           | Milky white | B3W-9012-R2N   |
|                             | Yellow                     | 1           | Yellow      | B3W-9012-Y1Y   |
|                             |                            | 1           | Milky white | B3W-9012-Y1N   |
|                             |                            | 2           | Yellow      | B3W-9012-Y2Y   |
|                             |                            | 2           | Milky white | B3W-9012-Y2N   |
|                             | Red+Blue                   | 2           | Milky white | B3W-9012-RB2N  |
|                             | Red+Green                  | 2           | Milky white | B3W-9012-RG2N  |
|                             | Red+High Brightness Green  | 2           | Milky white | B3W-9012-RHG2N |

## Specifications

### ■ Characteristics - initial (Same for Both Standard and High-force Switches)

|                               |   |
|-------------------------------|---|
| Contact form                  | SPST-NO Momentary   |
| Switching capacity            | 1 to 50 mA, 5 to 24 VDC (resistive load)  |
| Contact resistance            | 100 mΩ max. (initial value) (rated: 1 mA, 5 VDC)  |
| Insulation resistance         | 100 MΩ min. (at 250 VDC)  |
| Dielectric strength           | 500 VAC, 50/60 Hz for 1 min   |
| Bounce time                   | 5 ms max.   |
| Vibration resistance          | Malfunction: 10 to 55 Hz, 1.5 mm double amplitude   |
| Shock resistance              | Destruction: 1,000 m/s <sup>2</sup> (approx. 100 G) max.<br>Malfunction: 100 m/s <sup>2</sup> (approx. 10 G) max. |
| Ambient operating temperature | -25°C to 70°C (at 60% RH max.) with no icing or condensation  |
| Ambient operating humidity    | 35% to 85% (at 5° to 35°C)  |
| Life expectancy               | Switch section 160 gf (standard force): 1,000,000 operations min.<br>230 gf (high-force): 300,000 operations min. |

### ■ Operating Characteristics

| Item                      | Standard-force (B3W-90□0)                 | High-force (B3W-90□2) |
|---------------------------|---|-----------------------|
| Operating force (OF) max. | 160 gf                                    | 230 gf                |
| Releasing force (RF) min. | 20 gf                                     | 50 gf                 |
| Pretravel (PT)            | 0.25 <sup>+0.2</sup> / <sub>-0.1</sub> mm |                       |

# LED Specifications

| LED color                             | Red           | Green | Green (high brightness) | Yellow | Blue  |
|---------------------------------------|---------------|-------|-------------------------|--------|-------|
| Maximum Forward current $I_{FM}$      | 27 mA         | 27 mA | 27 mA                   | 45 mA  | 27 mA |
| Recommended operating current $I_F$   | 20 mA         | 20 mA | 10 mA                   | 20 mA  | 10 mA |
| Forward voltage (typical value) $V_F$ | 1.8 V         | 2.1 V | 3.7 V                   | 2.4 V  | 3.7 V |
| Maximum reverse voltage $V_R$         | 5 V           | 5 V   | 5 V                     | 5 V    | 5 V   |
| Ambient operating temperature         | -25°C to 70°C |       |                         |        |       |

**Note:** For Switches with two LEDs, red and green, the recommended operating current is 12 mA for the red and 20 mA for the green LED for application with three-color illumination.

## LEDs

### ■ Ambient Temperature vs Maximum Forward Current

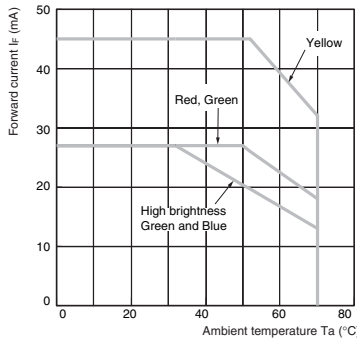

### ■ Forward Current and Forward Voltage Curves (Condition: $T_a=25^\circ\text{C}$ )

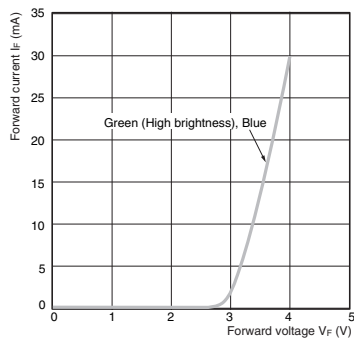
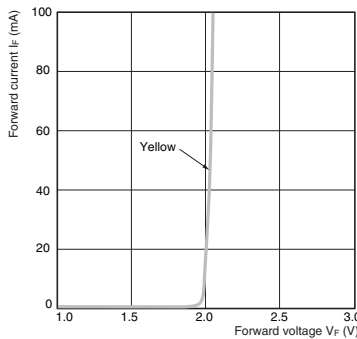
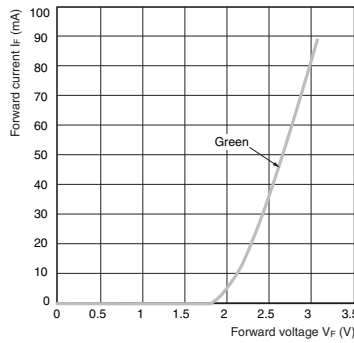

- Note:**
1. Pay attention to the polarity of each LED. The anode and cathode can be identified by finding the cathode mark, as indicated on the Dimensions page.
  2. Connect limiting resistors to the LEDs. The Switch does not have built-in limiting resistors, so satisfy the LED characteristics by obtaining the limiting resistance according to the following formula based on the voltage to be used.

$$\text{Limiting resistance (R)} = \frac{(\text{Voltage used (E)} - \text{LED forward voltage (VF)})}{\text{LED forward current (IF)}} (\Omega)$$



# Dimensions

Note: Unless otherwise specified, all units are in millimeters and a tolerance of  $\pm 0.4$  mm applies to all dimensions.

## 1 LED Types

B3W-900□-□1□

B3W-901□-□1□



PCB Mounting (Top View)



Terminal Arrangement/ Internal Connections (Top View)



Note: If the poles of the LED are set into it may result in malfunction.

Note: Terminal numbers are not printed on the Switch itself.

## 2 LED Types

B3W-900□-□2□

B3W-901□-□2□

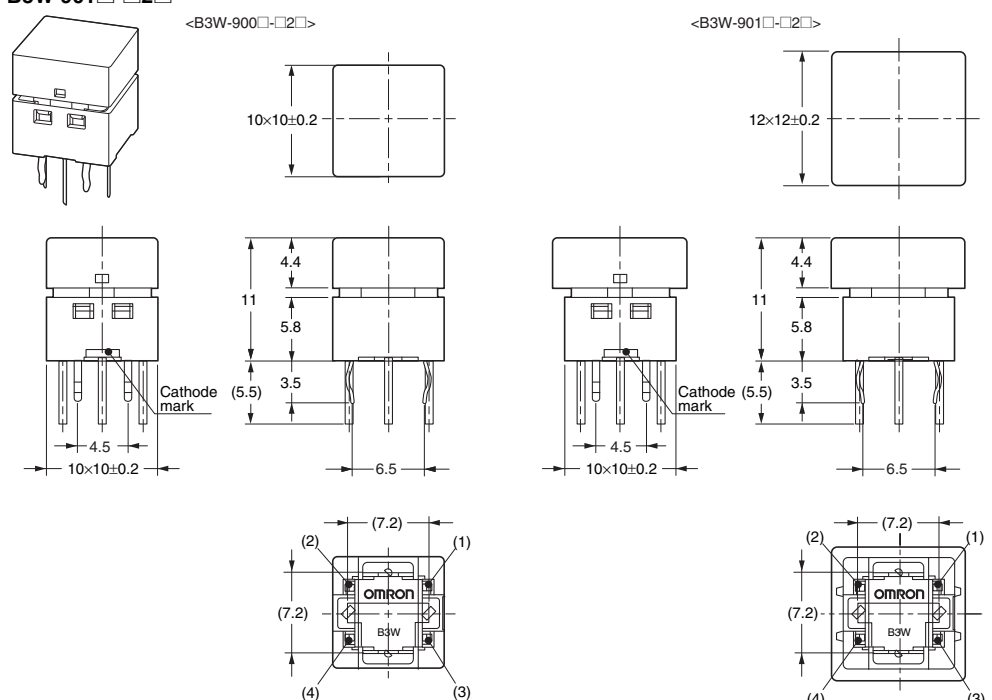

PCB Mounting (Top View)

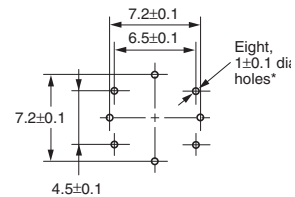

Terminal Arrangement/ Internal Connections (Top View)



Note 1: If the poles of the LED are set into it may result in malfunction.  
 2: For models with two-color LEDs, th of LED 1 is at position LED 1. The color of LED 2 is at the position B3W-90□□-RG2□

Note: Terminal numbers are not printed on the Switch itself.

# Accessories - Text Combination Films for B3W-9

## Text Combination Films for B3W-9 Illuminated Tactile Switches

- Display two different labels in combination with a single 2-LED B3W-9 Switch.
- Color combinations: Red/Green or Red/Blue



## Model Number Structure

**B3W-9**    -**F**  

1   2   3

### 1. Color

R: Red

### 2. Color

B: Blue

G: Green

### 3. Color and text combination

F1: Red      OFF  
 Blue or green      ON

F4: Red      ×  
 Blue or green      ○

F5: Red      ▼  
 Blue or green      ▲

**Note: 1.** Three 'text combinations' are available.

**2.** Films can also be customized with other text for 50 sheets (1,250 films) per lot. Delivery time is approximately five weeks. (Ask your OMRON representative for details.)

| Text Combinations | LED colors | Model             |
|-------------------|------------|-------------------|
| "OFF" and "ON"    | Red/Blue   | <b>B3W-9RB-F1</b> |
|                   | Red/Green  | <b>B3W-9RG-F1</b> |
| "×" and "○"       | Red/Blue   | <b>B3W-9RB-F4</b> |
|                   | Red/Green  | <b>B3W-9RG-F4</b> |
| "▼" and "▲"       | Red/Blue   | <b>B3W-9RB-F5</b> |
|                   | Red/Green  | <b>B3W-9RG-F5</b> |

**Note:** Minimum Order = 25 films/sheet (B3W-9 Films are sold in units of 25 films. Orders must be made in multiples of 25, the quantity per sheet.)

## Recommended B3W-9 Switches

**Note:** Use the following 2 LED versions of the B3W-9's with the above mentioned films for best results

| Operating force         | 2-LED Switches | Red/Blue      | Red/Bright green |
|-------------------------|----------------|---------------|------------------|
| Standard-force Switches |                | B3W-9000-RB2C | B3W-9000-RHG2C   |
| High-force Switches     |                | B3W-9002-RB2C | B3W-9002-RHG2C   |

**Note:** Text Combination Films are sold without the Switches. Order one of the above models of B3W-9 Illuminated Tactile Switches separately.

# Safety Precautions

## ■ Precautions for Correct Use

### Electrical Standards

All Use the Switch within the rated voltage and current ranges, otherwise the Switch may have a shortened life expectancy, radiate heat, or burn out. This particularly applies to the instantaneous voltages and currents when switching.

### Soldering

#### 1. Soldering Precautions

- Before any kind of soldering, test to confirm that soldering can be performed properly. Otherwise the Switch may be deformed by the soldering heat depending on the type of PCB, pattern, or lands of the PCB.
- Do not solder the Switch more than twice, including rectification soldering. Wait for at least five minutes between the first and second soldering to allow the temperature to return to normal. Continuous soldering may cause the casing to melt or deteriorate the Switch characteristics.

#### 2. Automatic Soldering Baths (Wave Soldering)

- Soldering temperature: 260°C max.
- Soldering time: 5 s max. for a 1.6-mm thick single-side PCB
- Preheating temperature: 100°C max. (ambient temperature)
- Preheating time: Within 60 s
- Precautions  
Make sure that no flux will rise above the level of the PCB. Also make sure that flux is not applied to the switch terminals or to the mounting surface of the PCB. If flux overflows onto the mounting surface of the PCB, it may enter the Switch and cause a malfunction.

#### 3. Manual Soldering

- Soldering temperature: 350°C max. at the tip of the soldering iron
- Soldering time: 3 s max. for a 1.6-mm thick, single-side PCB
- Precautions: Before soldering the Switch on a PCB, make sure that there is no unnecessary space between the Switch and the PCB.

### Washing

Since Illumination part and actuation part are not sealed, switch cannot be washed. Doing so will cause the washing agent, together with flux or dust particles on the PCB, to enter the Switch, resulting in malfunction.

### PCBs

The Switch is designed for a 1.6-mm thick, single-side PCB. Using PCBs with a different thickness or using double-sided, through-hole PCBs may result in loose mounting, improper insertion, or poor heat resistance in soldering. These effects will occur, depending on the type of holes and patterns of the PCB.

Therefore, it is recommended that a verification test is conducted

### Handling

#### 1. Usage Environment

Before installing the Switch, make sure that the area of installation is not subject to corrosive gases emitted from surrounding parts.

Do not use in areas subject to high temperatures, high humidity, or toxic gases such as sulfuric gas (H<sub>2</sub>S, SO<sub>2</sub>), ammonia gas (NH<sub>3</sub>), nitric gas (HNO<sub>3</sub>), or chlorine gas (Cl<sub>2</sub>). It can cause

corrosive damage to the contacts and result in malfunction. If there is silicon in the atmosphere, it may stop the contacts from functioning properly.

If silicon products, such as silicon oil, silicon filler, or silicon wires, are used in the surrounding area, install a contact protection circuit to prevent arching or remove the silicon source.

The following situations may cause water to enter inside the Switch, resulting in a malfunction due to contact failure or corrosion.

- Using the Switch in an outdoor environment where it is exposed to water drops for an extended period of time.
- Using the Switch in an underwater setting where it is subject to strong water pressure.

Do not use Switches that have been dropped. The mating section or other internal parts may be damaged, resulting in malfunction.

### Operation

Do not repeatedly operate the Switch with excessive force. Applying excessive pressure or applying additional force after the plunger has stopped may deform the disk spring of the Switch, resulting in malfunction.

Be sure to set up the Switch so that the plunger will operate in a straight vertical line.

If the plunger is pressed off-center or from an angle it may cause deformation or damage to some parts. This may result in deterioration of durability or malfunction.

**Removing the Cap - Text Film Installation**

1. Hold the cap at the side away from the mating section. Pull straight up.
2. Do not remove the cap while the Switch is mounted. Doing so will apply force to the soldered section and LEDs, resulting in malfunction.



**Placing the Cap on the Switch**

Hold the Cap at the side away from the mating section. Push straight down until the mating section meets.

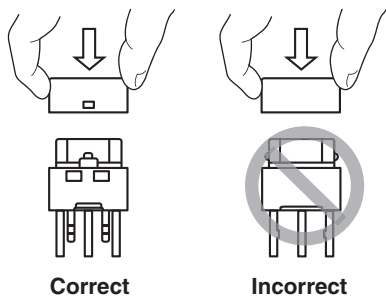

**Removing the Cap**

The Cap can be removed up to two times. Excessively removing the Cap will cause the mating section to become weak, resulting the operating section not mating completely or the Cap may fall off.

**Film Dimensions**

Dimensions of the film are shown below. The thickness is 0.2 mm.

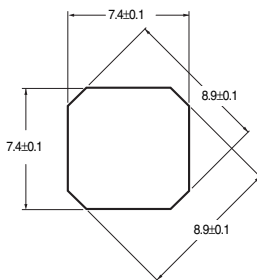

**Dust Protection**

Although the switching mechanism is a sealed structure (IP64), illumination part and actuation part is not sealed. Ensure you have the correct environmental conditions for installation. Use a protective sheet or take other measures to protect against dust.

**Sensitivity to Static Electricity**

Switches with high-brightness green (HG) or blue (B) LEDs are susceptible to static electricity. Take care when handling switches with these LEDs as the LEDs may be damaged.

**Storage Precautions**

**Storage Environment**

To prevent degradation, such as discoloration, of the terminals during storage, do not store the Switch in locations that are subject to the following conditions.

1. High temperature or humidity
2. Corrosive gases
3. Direct sunlight

**Storage condition**

Store the Switches in the packaging box.

After the packaging box is opened, use the contents as quickly as possible. When storing leftover parts, make sure that appropriate measures are taken against humidity and corrosive gases.

**Agreement of Product Use**

Comply with the usage, storage, and disposal conditions specified by OMRON as outlined in the precautions in the product datasheet and specifications.

Be sure to read the precautions common to all Tactile Switches, contained in the Technical User's Guide, "Tactile Switches, Technical Information" for correct use





All sales are subject to Omron Electronic Components LLC standard terms and conditions of sale, which can be found at [http://www.components.omron.com/components/web/webfiles.nsf/sales\\_terms.html](http://www.components.omron.com/components/web/webfiles.nsf/sales_terms.html)

**ALL DIMENSIONS SHOWN ARE IN MILLIMETERS.**  
To convert millimeters into inches, multiply by 0.03937. To convert grams into ounces, multiply by 0.03527.



**OMRON ELECTRONIC COMPONENTS LLC**  
55 E. Commerce Drive, Suite B  
Schaumburg, IL 60173

**847-882-2288**

**OMRON ON-LINE**

Global - <http://www.omron.com>  
USA - <http://www.components.omron.com>



Компания «ЭлектроПласт» предлагает заключение долгосрочных отношений при поставках импортных электронных компонентов на взаимовыгодных условиях!

Наши преимущества:

- Оперативные поставки широкого спектра электронных компонентов отечественного и импортного производства напрямую от производителей и с крупнейших мировых складов;
- Поставка более 17-ти миллионов наименований электронных компонентов;
- Поставка сложных, дефицитных, либо снятых с производства позиций;
- Оперативные сроки поставки под заказ (от 5 рабочих дней);
- Экспресс доставка в любую точку России;
- Техническая поддержка проекта, помощь в подборе аналогов, поставка прототипов;
- Система менеджмента качества сертифицирована по Международному стандарту ISO 9001;
- Лицензия ФСБ на осуществление работ с использованием сведений, составляющих государственную тайну;
- Поставка специализированных компонентов (Xilinx, Altera, Analog Devices, Intersil, Interpoint, Microsemi, Aeroflex, Peregrine, Syfer, Eurofarad, Texas Instrument, Miteq, Cobham, E2V, MA-COM, Hittite, Mini-Circuits, General Dynamics и др.);

Помимо этого, одним из направлений компании «ЭлектроПласт» является направление «Источники питания». Мы предлагаем Вам помощь Конструкторского отдела:

- Подбор оптимального решения, техническое обоснование при выборе компонента;
- Подбор аналогов;
- Консультации по применению компонента;
- Поставка образцов и прототипов;
- Техническая поддержка проекта;
- Защита от снятия компонента с производства.



#### Как с нами связаться

**Телефон:** 8 (812) 309 58 32 (многоканальный)

**Факс:** 8 (812) 320-02-42

**Электронная почта:** [org@eplast1.ru](mailto:org@eplast1.ru)

**Адрес:** 198099, г. Санкт-Петербург, ул. Калинина, дом 2, корпус 4, литера А.