



Easy-to-Install
High Performance
Terminals

Section	Page
Terminals, Kits and Tools	5-79
3M™ Scotchlok™ Ring Tongues	12-20
3M™ Scotchlok™ Multi-Stud Ring Tongues	21
3M™ Scotchlok™ Compression Lug Ring Tongues.....	22
3M™ Scotchlok™ Standard Forks	23-26
3M™ Scotchlok™ Block Forks.....	27-31
3M™ Scotchlok™ Flanged Block Forks	32-34
3M™ Scotchlok™ Locking Forks	34-39
3M™ Scotchlok™ Butt Connectors.....	40-45
3M™ Scotchlok™ Female Disconnects.....	45-55
3M™ Scotchlok™ Male Disconnects	56-60
3M™ Scotchlok™ Piggy-Back Disconnects.....	61
3M™ Scotchlok™ Adapters	62
3M™ Scotchlok™ High Temperature Terminals	63-66
3M™ Scotchlok™ Pin Terminals	67-68
3M™ Scotchlok™ Closed End Connectors	69
3M™ Scotchlok™ Parallel Connectors	70
3M™ Highland™ Terminals	71-77
Kits and Tools.....	78-79

Terminals, Kits and Tools

3M has been a leading supplier of terminals for more than 30 years. Our satisfied customers know our products for:

- Effective and reliable performance.
- Variety of types, sizes and materials that meet a broad application range, including the demands of temperature and weather.
- Design features assuring easy installation of 3M™ Products—positive and easy wire insertion, elimination of strand hang-ups and wire twisting, and easy insulation entry. These are a few of the characteristics that make the installer's job easier.

Customers can choose from two terminal families to meet their needs.

3M™ Scotchlok™ Terminals

Our premier line of terminals allow for various insulation types (such as heat shrink, nylon, vinyl, or non-insulated). Various barrel styles are available (such as butted, brazed, seamless, or interlocking barrel). Additionally, our premier terminals come in bottle or bulk packaging.

3M™ Highland™ Terminals

These terminals are either vinyl or nylon insulated with a butted seam. They come packaged in small quantities in reclosable plastic bags.

3M Terminals help accommodate the installer's needs.



Glossary of Terminals and Tools Terms

ADAPTERS

To interconnect two connectors already attached to wires.

BLOCK FORK

Same strength as the fork, but designed to use in terminal block because sides lie flat against barrier portion of terminal block.

BULLET STYLE SNAP PLUG

Similar advantages as disconnects. Gives reliable in-line connection because parts are made to have holding friction when joined. Usually for automotive use.

BUTT

Uses chamfered barrel ends to provide fast, easy wire insertion from both ends and a built-in wire stop for correct positioning. Must be crimped at both ends.

CLOSED-END

Used in situations requiring pigtail of two or more wires.

FLANGED FORK

Gives the benefit of both the block and locking forks. Stays secure should screw loosen.

FORK

Allows rapid connection of wire. Usually used on free-standing studs, because of wider tongues.

LOCKING FORK

The spring-like tongue locks in place around the stud even when mount screw is not tightened. Extra force is required to remove from stud.

PARALLEL

Similar to butt with overlapped wires and single crimp in center of connector. Used where space is limited.

PINS

For installation in compression blocks. Used in Europe for terminating stranded wire.

QUICK CONNECT (DISCONNECT)

Attached to mating part by tongue of female part slipping over male tab. Use of dents and rolled edges on female part provides excellent holding force while allowing easy and quick disconnect.

RING

The standard style of tongue. The safest and most reliable 3M terminal. It cannot be removed unless mounting screw is removed.

TAB

Uses mounting hole for rivet or screw.

TAP

No wire stripping is necessary, just lay wire in connector and crimp. Connection is made.

Standard Terminal Construction



3M™ Terminals provide a variety of design features assuring consistently effective, reliable performance and easy installation.

Please refer to the illustrations at the numbered locations for the attributes described below.

1. One-piece, burr-free construction provides maximum electrical conductivity. Electrical bright-tin plating gives maximum corrosion resistance. Annealing relieves stress points and provides maximum installed strength.
2. Barrel-to-pad transition design minimizes flexing and bending.
3. Open-end design permits visual inspection of wire location before and after crimping.
4. Maximum hold on wire comes from multiple “V” grooves in #22–4 AWG parts resulting in excellent holding power.
5. Injection molded insulations on terminals are the highest quality in the industry.
 - 221°F (105°C)* rated, tough, resistant electrical grade materials
 - Molding ensures consistent wall thickness for maximum reliability after crimping
 - Molding allows funnel barrel construction for easier installation
 - Molding offers the crimp ridge and non-slip ridge
6. Crimp ridge designed for positive location of tool on terminal barrel, resulting in few miscrimps.
7. Funnel barrel construction provides:
 - Positive, easy wire insertion
 - Virtually no hang-ups of wire strands
 - Wire twisting not necessary

*Products made in U.S.A. only.

8. Nylon-insulated terminals with grip feature a brass sleeve. Sleeve provides optimum grip on insulation, strain relief and vibration protection. Brass sleeve is recessed which provides excellent flash-over protection.

9. Non-slip ridge so tool slides to correct position for a proper crimp and better workmanship.

10. Beveled leading edge for easy wire insulation entry.

Barrel Styles

Non-Insulated Butted Seam

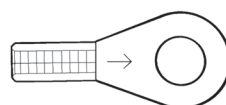

The most economical 3M terminal—used where special performance or installation characteristics are not needed. Beveled mouth facilitates wire insertion. Maximum temperature for bare terminals: 347°F (175°C).

Non-Insulated Brazed Seam

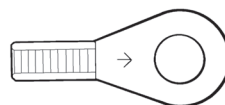

Beveled mouth facilitates wire insertion. Can be crimped anywhere on barrel surface. Silver brazed seam will not open under crimping pressure or operating stresses. Unlike butted seam parts, stranded wire cannot escape barrel confines during or after crimping. Maximum temperature for bare terminals: 347°F (175°C).

Vinyl Insulated Brazed and Butted Seams

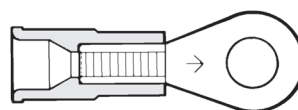

Used where insulated barrel is necessary and desirable. Terminal consists of brazed or butted part with flared, rigid molded polyvinyl chloride sleeve securely attached and funneled for easy wire entry. Wire insulation positions itself against funnel portion of vinyl sleeve thus virtually eliminating strand hang-up. Crimping barrel and flared portion of sleeve provide excellent electrical contact plus mechanical stress relief at junction of insulation and barrel. Insulation has a non-slip ridge for ease of positioning crimping tool.

Nylon Insulated Butted Seam with Insulation Grip



Used where insulated barrel and positive insulation grip are necessary or desirable. Terminal consists of butted seam part with flared, seamless brass sleeve securely attached and covered with flared, molded nylon sleeve. Wire insulation positions itself against funnel portion of brass sleeve. Crimping barrel and flared portion of sleeve provide excellent electrical contact plus mechanical stress relief at junction of insulation and barrel. Positioning crimp tool is nearly mistake proof due to a “step” in nylon insulation. Industry standard color coding indicates wire range. Insulators are rated at a continuous operating temperature range from -40°F to 221°F (-40°C to 105°C)*.

UL Listed and CSA Certified for 600V building wire and 1000V signs and lighting fixtures (luminaries)*.

Installation Procedure

Funnel Barrel Feature provides an excellent electrical and mechanical connection.

- Funnel design guides wire into position.



- No wire strand hang-up as the wire is inserted, giving a fast, positive installation.



- Wire is in place, ready for crimping.



For maximum crimping performance, barrel of connector must be properly indexed in the crimp tool station.

*Products made in U.S.A. only.

Correct crimping is important to assure a strong connection.

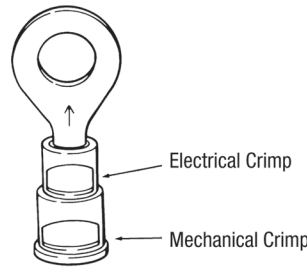

Insulated Terminals and Connectors:



Non-Insulated Terminals and Connectors:

Indent should be opposite the barrel seam.

Heat Shrink Terminals, Connectors and Disconnects

3M™ Heat Shrink Pre-insulated Terminals, Connectors and Disconnects protect against the most challenging of environments, making the best moisture protection available. They offer several advantages over conventional unsealed products.

Corrosion Resistance

The adhesive-lined heat shrink material, when properly crimped and shrunk, provides a seal resistant to water, salt, steam and other related contaminants.

Improved Mechanical Performance

The adhesive-lined heat shrink tubing adheres, when shrunk, to both the connector and the wire insulation providing improved pullout strength and strain relief.

Durable Heat Shrink Tubing

Tough heat shrink tubing effectively resists abrasion, scoring, cut-through, and the effects of long-term aging.

Versatile and Easy to Use

3M heat shrink terminals, splices and disconnects are available in wire sizes 22–10 AWG and can be installed easily with a recommended tool and heat source. The connectors are color-coded for wire range identification and the transparent tubing allows for visual inspection.

Application Procedure for Heat Shrink Products:

1. Strip wires to appropriate length as indicated on package label.



2. Insert wire into terminal and crimp with correct station of a recommended tool.



3. Apply heat with a recommended heat source.



High Temperature Terminals and Connectors

3M™ High Temperature Terminals and Connectors are constructed of steel with a nickel plating. Their temperature rating for continuous use at 900°F (482°C) makes them ideal for use in ovens, motors, light fixtures and other applications where other connectors could corrode or melt.

There is no applicable UL or CSA standard for high temperature steel parts.

Standard Crimp Terminal and Connector Specifications

Materials

Crimp terminals and connectors are to be burr-free, annealed and bright-tin plated ETP copper. Barrels shall be 0.25" long with brazed seams where specified. Insulation grip sleeves are to be tin-plated brass and attached securely to the barrel. Terminal insulators are to be molded polyvinyl chloride or nylon, UL Listed and CSA Certified for 600V in building wire and 1000V in signs and lighting fixtures (luminaries)*. Connector insulators are to be extruded polyvinyl chloride or nylon with a temperature rating of 221°F (105°C)*.

Construction

Most insulated terminals are to have funnel entry construction* to prevent strand hang-up and a crimp ridge for proper tool location. Nylon insulated terminals and connectors are to have butted seam barrels with insulation grip sleeves. Terminal barrels are to have multiple “V” grooves for maximum conductor retention.

*Products made in U.S.A. only.



Note: All dimensions are measured in inches.

FREQUENTLY ASKED QUESTIONS

What does the insulation grip do?

The insulation grip provides a “second” crimp on the wire insulation providing additional wire strain relief. It's excellent for high vibration applications.

What's the difference between insulated and fully insulated disconnects?

Insulated disconnects have barrel insulation only and fully insulated disconnects are insulated from the barrel to the receptacle/tab.

What temperatures do 3M terminals withstand?

Non-insulated 3M terminals withstand temperatures up to 347°F (175°C). Insulated 3M terminals withstand temperatures up to 221°F (105°C).

3M™ Terminal Numbering System

3M Identity	Code/Barrel Style	Wire Size Code (AWG)	–	Stud, Tab, or Bullet Size	Tongue Code	Product Availability**
M	No Code = Bare Brazed	24 = 26–24 (yellow)	–	(STUD)	F = Fork	All bottle (X) or bag (Q) package terminals in this catalog are available (in the packaging quantity indicated) from local distributor stocks. All bulk (K) packaged terminals are available in full cartons only, and may require a three to five week order lead time from the factory.
	A = No Barrel (adapter)	20 = 26–20 (yellow)		0 = 0	FB = Fork, Block	
	I = Double Wall w/interlock	18 = 22–18 (red)		2 = 2	FBHT = Fork, Block, High Temp.	
	N = Nylon Brazed	14 = 16–14 (blue)		4 = 4	FFB = Fork, Flanged, Block	
	NG = Nylon w/ Grip	10 = 12–10 (yellow)		6 = 6	FHT = Fork, High Temp.	
	NHU = Nylon/Butted	8 = 8 (red)		8 = 8	FL = Fork, Locking	
	w/ Heat Shrink Over Top	6 = 6 (blue)		10 = 10	R = Ring	
	NU = Nylon/Butted	4 = 4 (yellow)		12 = 1/2"	RHD = Ring, Heavy Duty	
	U = Bare/Butted			14 = 1/4"	RHT = Ring, High Temp.	
	V = Vinyl/Brazed			38 = 3/8"	/S = Short or Small	
	VA = Vinyl Adapter			516 = 5/16"	/L = Large or Long	
	VU = Vinyl/Butted			610 = 6, 8, 10	R/Flag = Ring, Flag	
					BC = Butt Connector	
					CEC = Closed End Connector	
					P = Pin Connector	
					PC = Parallel Connector	
					BCM = Butt Connector	
					Moisture Res.	
					CEC/ST = Closed End Connector	
					Disconnect	
					DF = Female	
					DFHT = Female, High Temp.	
					DFI = Female, Fully Insulated	
					DM = Male	
			DMF = Male, Female			
			DMHT = Male, High Temp.			
			DMI = Male, Fully Insulated			
			DF/Flag = Female Flag Adapter			
			D = Disconnects			
			F = Female			
			FFI = Double Female, Fully Insulated			
			M = Male			
			MMI = Double Male, Fully Insulated			
			MMF = Double Male, Female			
			MFM = Male, Female, Male, Stacking			
			RR = Ring Rectangular Tongue			
			Fuse = Fuse Adapter Clip			

* A dash (–) separates the wire size code from the stud, tab or bullet size code.

** Denotes product packaging. Packaging of 3M Scotchlok™ terminals should be specified by using the appropriate terminal part number. Suffix letters are indicated within each product number. (See "Product Number" heading in ordering information charts.)

Product numbers ending with "-A" are made in Taiwan.

Note: Contact your local distributor or 3M sales office for price and delivery information.

Map of Numbering System

Example:

Catalog Number: MNG18-4 FB/SK

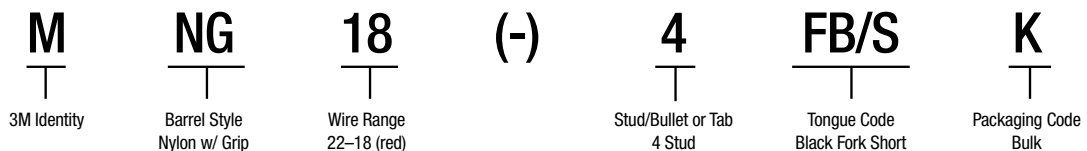

Insulator Color Coding

Yellow (26-24 AWG) Red (22-18 AWG) Blue (16-14 AWG) Yellow (12-10 AWG) Red (8 AWG) Blue (6 AWG) Yellow (4 AWG)

*Product number ending in X = bottle; product number ending with K = bulk; product number ending with Q = bag

3M™ Terminal Stud Size Chart

	Stud Size			OUS/Metric	Diameter	3M Terminal Hole Diameter
	US/Inches	Diameter				
#2		0.086" (2,144 mm)	M2		2,0 mm (0.080")	0.095" (2,4 mm)
#4		0.112" (2,844 mm)	M2,5		2,5 mm (0.100")	0.120" (3,0 mm)
#5		0.125" (3,175 mm)	M3		3,0 mm (0.120")	0.148" (3,8 mm)
#6		0.138" (3,505 mm)	M3,5		3,5 mm (0.140")	0.148" (3,8 mm)
#8		0.164" (4,166 mm)	M4		4,0 mm (0.176")	0.174" (4,4 mm)
#10		0.190" (4,826 mm)	M5		5,0 mm (0.20")	0.200" (5,1 mm)
1/4		0.250" (6,350 mm)	M6		6,0 mm (0.24")	0.265" (6,7 mm)
5/16		0.3125" (7,938 mm)	M8		8,0 mm (0.32")	0.328" (8,3 mm)
3/8		0.375" (9,525 mm)	M10		10,0 mm (0.40")	0.397" (10,1 mm)
7/16		0.4375" (11,113 mm)	M10		10,0 mm (0.48")	0.450" (11,4 mm)
1/2		0.500" (12,700 mm)	M12		12,0 mm (0.48")	0.515" (13,1 mm)
5/8		0.625" (15,875 mm)	M16		16,0 mm (0.64")	0.656" (16,7 mm)
3/4		0.750" (19,050 mm)	M18		18,0 mm (0.72")	0.781" (19,8 mm)

Ref: ISO 263-1973 for inch stud sizes and ISO 262-1973 for metric stud sizes.

American Wire Gauge

Size	Inches	Millimeters	Size	Inches	Millimeters	Size	Inches	Millimeters
4/0	0.4600	11,684	4	0.2043	5,189	16	0.0508	1,290
3/0	0.4096	10,040	6	0.1620	4,115	18	0.0403	1,024
2/0	0.3648	9,266	8	0.1285	3,264	20	0.0320	0,813
1/0	0.3249	8,253	10	0.1019	2,588	22	0.0253	0,643
1	0.2893	7,347	12	0.0808	2,052	24	0.0201	0,511
2	0.2576	6,543	14	0.0641	1,628	26	0.0159	0,404

3M™ Scotchlok™ Ring Tongues

Heat Shrink Brazed Seam Ring Tongues

Terminal Type Ring
 Terminal Style Standard
 Insulation Material Heat Shrink
 Barrel Style Brazed
 RoHS 2011/65/EU Yes

Manufacturing Origin

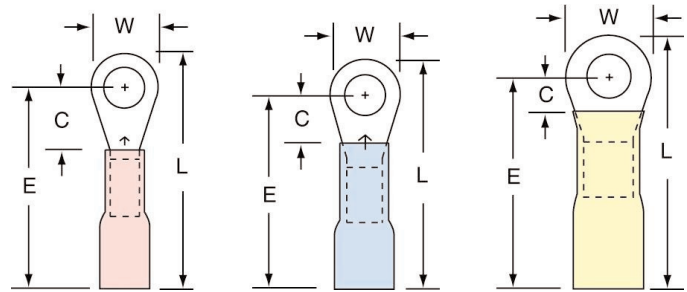

Order No.	UPC	Conductor Size	Stud Size	(W)	(C)	(L)	(E)	Thickness	Barrel I.D.	Terminals per Carton	Terminals per Case
MH18-6R/LK	054007-06345	22 - 18 AWG	6	0.31"	0.15"	1.00"	0.84"	0.030"	0.070"	-	250
MH18-6R/LX	051128-58910	22 - 18 AWG	6	0.31"	0.15"	1.00"	0.84"	0.030"	0.070"	25	125
MH18-8R/LK	054007-06349	22 - 18 AWG	8	0.31"	0.18"	1.00"	0.84"	0.030"	0.070"	-	250
MH18-8R/LX	051128-58912	22 - 18 AWG	8	0.31"	0.18"	1.00"	0.84"	0.030"	0.070"	25	125
MH18-10R/LK	054007-06351	22 - 18 AWG	10	0.31"	0.20"	1.00"	0.84"	0.030"	0.070"	-	250
MH18-10R/LX	051128-58914	22 - 18 AWG	10	0.31"	0.20"	1.00"	0.84"	0.030"	0.070"	25	125
MH14-6R/LK	054007-06321	16 - 14 AWG	6	0.31"	0.15"	1.00"	0.84"	0.030"	0.090"	-	250
MH14-6R/LX	051128-58898	16 - 14 AWG	6	0.31"	0.15"	1.00"	0.84"	0.030"	0.090"	25	125
MH14-8R/LK	054007-06325	16 - 14 AWG	8	0.31"	0.18"	1.00"	0.84"	0.030"	0.090"	-	250
MH14-8R/LX	051128-58900	16 - 14 AWG	8	0.31"	0.18"	1.00"	0.84"	0.030"	0.090"	25	125
MH14-10R/LK	054007-06327	16 - 14 AWG	10	0.31"	0.20"	1.00"	0.84"	0.030"	0.090"	-	250
MH14-10R/LX	051128-58901	16 - 14 AWG	10	0.31"	0.20"	1.00"	0.84"	0.030"	0.090"	25	125
MH14-14R/SK	054007-06331	16 - 14 AWG	1/4"	0.47"	0.26"	1.10"	0.86"	0.030"	0.090"	-	250
MH14-14R/SX	051128-58903	16 - 14 AWG	1/4"	0.47"	0.26"	1.10"	0.86"	0.030"	0.090"	25	125
MH14-516R/SK	054007-06337	16 - 14 AWG	5/16"	0.47"	0.33"	1.10"	0.86"	0.030"	0.090"	-	250
MH14-516R/SX	051128-58906	16 - 14 AWG	5/16"	0.47"	0.33"	1.10"	0.86"	0.030"	0.090"	25	125
MH14-38RK	054007-06335	16 - 14 AWG	3/8"	0.56"	0.28"	1.10"	0.87"	0.030"	0.090"	-	250
MH14-38RX	051128-58905	16 - 14 AWG	3/8"	0.56"	0.28"	1.10"	0.87"	0.030"	0.090"	25	125
MH10-8RK	054007-06303	12 - 10 AWG	8	0.38"	0.19"	1.10"	0.91"	0.040"	0.145"	-	250
MH10-8RX	051128-58888	12 - 10 AWG	8	0.38"	0.19"	1.10"	0.91"	0.040"	0.145"	25	125
MH10-10RK	054007-06306	12 - 10 AWG	10	0.38"	0.21"	1.10"	0.90"	0.040"	0.145"	-	250
MH10-10RX	051128-58890	12 - 10 AWG	10	0.38"	0.21"	1.10"	0.90"	0.040"	0.145"	25	125
MH10-14RK	054007-06359	12 - 10 AWG	1/4"	0.59"	0.29"	1.20"	0.90"	0.040"	0.145"	-	250
MH10-14RX	051128-58892	12 - 10 AWG	1/4"	0.59"	0.29"	1.20"	0.90"	0.040"	0.145"	25	125
MH10-38RK	054007-06313	12 - 10 AWG	3/8"	0.59"	0.29"	1.20"	0.90"	0.040"	0.145"	-	250
MH10-38RX	051128-58894	12 - 10 AWG	3/8"	0.59"	0.29"	1.20"	0.90"	0.040"	0.145"	25	125

Nylon Insulated with Insulation Grip Ring Tongues

Terminal Type Ring
 Terminal Style Standard
 Insulation Material Nylon with Insulation Grip
 Barrel Style Butted
 RoHS 2011/65/EU Yes

Agency Approval



Manufacturing Origin



Order No.	UPC	Conductor Size	Stud Size	(W)	(C)	(L)	(E)	Thickness	Barrel I.D.	Max. Insul. Dia.	Terminals per Carton	Terminals per Case
MNG18-4R/SK	054007-01062	22 - 18 AWG	4	0.25"	0.22"	0.79"	0.66"	0.030"	0.070"	0.145"	-	1000
MNG18-4R/SX	051128-58943	22 - 18 AWG	4	0.25"	0.22"	0.79"	0.66"	0.030"	0.070"	0.145"	100	500
MNG18-6R/SK	054007-16163	22 - 18 AWG	6	0.25"	0.22"	0.79"	0.66"	0.030"	0.070"	0.145"	-	1000
MNG18-6R/SX	051128-58642	22 - 18 AWG	6	0.25"	0.22"	0.79"	0.66"	0.030"	0.070"	0.145"	100	500
MNG18-8R/LK	054007-01069	22 - 18 AWG	8	0.31"	0.33"	0.92"	0.77"	0.030"	0.070"	0.145"	-	1000
MNG18-8R/LX	051128-58644	22 - 18 AWG	8	0.31"	0.33"	0.92"	0.77"	0.030"	0.070"	0.145"	100	500
MNG18-10R/LK	054007-01071	22 - 18 AWG	10	0.31"	0.33"	0.92"	0.77"	0.030"	0.070"	0.145"	-	1000
MNG18-10R/LX	051128-58643	22 - 18 AWG	10	0.31"	0.33"	0.92"	0.77"	0.030"	0.070"	0.145"	100	500
MNG18-14R/SK	054007-01072	22 - 18 AWG	1/4"	0.47"	0.40"	1.07"	0.84"	0.030"	0.070"	0.145"	-	1000
MNG18-14R/SX	051128-58944	22 - 18 AWG	1/4"	0.47"	0.40"	1.07"	0.84"	0.030"	0.070"	0.145"	100	500
MNG18-516R/SX	051128-58945	22 - 18 AWG	5/16"	0.47"	0.40"	1.07"	0.84"	0.030"	0.070"	0.145"	100	500
MNG18-38RK	054007-01076	22 - 18 AWG	3/8"	0.56"	0.40"	1.12"	0.84"	0.030"	0.070"	0.145"	-	1000
MNG18-38RX	051128-58946	22 - 18 AWG	3/8"	0.56"	0.40"	1.12"	0.84"	0.030"	0.070"	0.145"	100	500
MNG14-4R/SX	051128-58962	16 - 14 AWG	4	0.25"	0.22"	0.81"	0.68"	0.030"	0.090"	0.170"	100	500
MNG14-6R/SK	054007-01430	16 - 14 AWG	6	0.25"	0.22"	0.81"	0.68"	0.030"	0.090"	0.170"	-	1000
MNG14-6R/SX	051128-58661	16 - 14 AWG	6	0.25"	0.22"	0.81"	0.68"	0.030"	0.090"	0.170"	100	500
MNG14-8RK	054007-01434	16 - 14 AWG	8	0.33"	0.29"	0.91"	0.75"	0.030"	0.090"	0.170"	-	1000
MNG14-8RX	051128-58964	16 - 14 AWG	8	0.33"	0.29"	0.91"	0.75"	0.030"	0.090"	0.170"	100	500
MNG14-8R/SK	054007-01433	16 - 14 AWG	8	0.25"	0.22"	0.81"	0.68"	0.030"	0.090"	0.170"	-	1000
MNG14-8R/SX	051128-58963	16 - 14 AWG	8	0.25"	0.22"	0.81"	0.68"	0.030"	0.090"	0.170"	100	500
MNG14-8R/LK	054007-01435	16 - 14 AWG	8	0.31"	0.33"	0.94"	0.79"	0.030"	0.090"	0.170"	-	1000
MNG14-8R/LX	051128-58704	16 - 14 AWG	8	0.31"	0.33"	0.94"	0.79"	0.030"	0.090"	0.170"	100	500
MNG14-10RK	054007-14150	16 - 14 AWG	10	0.33"	0.29"	0.91"	0.75"	0.030"	0.090"	0.170"	-	1000
MNG14-10RX	051128-58965	16 - 14 AWG	10	0.33"	0.29"	0.91"	0.75"	0.030"	0.090"	0.170"	100	500
MNG14-10R/LX	051128-58662	16 - 14 AWG	10	0.31"	0.33"	0.94"	0.79"	0.030"	0.090"	0.170"	100	500
MNG14-10R/LK	054007-01437	16 - 14 AWG	10	0.31"	0.33"	0.94"	0.79"	0.030"	0.090"	0.170"	-	1000
MNG14-14R/SK	054007-01438	16 - 14 AWG	1/4"	0.47"	0.40"	1.09"	0.86"	0.030"	0.090"	0.170"	-	1000
MNG14-14R/SX	051128-58663	16 - 14 AWG	1/4"	0.47"	0.40"	1.09"	0.86"	0.030"	0.090"	0.170"	100	500
MNG14-516R/SK	054007-01440	16 - 14 AWG	5/16"	0.47"	0.40"	1.09"	0.86"	0.030"	0.090"	0.170"	-	1000
MNG14-516R/SX	051128-58967	16 - 14 AWG	5/16"	0.47"	0.40"	1.09"	0.86"	0.030"	0.090"	0.170"	100	500
MNG14-38RK	054007-01442	16 - 14 AWG	3/8"	0.56"	0.40"	1.14"	0.86"	0.030"	0.090"	0.170"	-	1000
MNG14-38RX	051128-58968	16 - 14 AWG	3/8"	0.56"	0.40"	1.14"	0.86"	0.030"	0.090"	0.170"	100	500
MNG10-4R/SK	054007-01932	12 - 10 AWG	4	0.28"	0.29"	0.98"	0.84"	0.040"	0.135"	0.250"	-	500
MNG10-6RK	054007-01934	12 - 10 AWG	6	0.38"	0.29"	1.03"	0.84"	0.040"	0.135"	0.250"	-	500

3M™ Scotchlok™ Ring Tongues

Nylon Insulated with Insulation Grip Ring Tongues (continued)

Order No.	UPC	Conductor Size	Stud Size	(W)	(C)	(L)	(E)	Thickness	Barrel I.D.	Max. Insul. Dia.	Terminals per Carton	Terminals per Case
MNG10-6RX	051128-58684	12 - 10 AWG	6	0.38"	0.29"	1.03"	0.84"	0.040"	0.135"	0.250"	50	500
MNG10-8RK	054007-01936	12 - 10 AWG	8	0.38"	0.29"	1.03"	0.84"	0.040"	0.135"	0.250"	-	500
MNG10-8RX	051128-58685	12 - 10 AWG	8	0.38"	0.29"	1.03"	0.84"	0.040"	0.135"	0.250"	50	500
MNG10-10RK	054007-01937	12 - 10 AWG	10	0.38"	0.29"	1.03"	0.84"	0.040"	0.135"	0.250"	-	500
MNG10-10RX	051128-58686	12 - 10 AWG	10	0.38"	0.29"	1.03"	0.84"	0.040"	0.135"	0.250"	50	500
MNG10-14R/SK	054007-01938	12 - 10 AWG	1/4"	0.53"	0.44"	1.26"	0.99"	0.040"	0.135"	0.250"	-	500
MNG10-14R/SX	051128-58715	12 - 10 AWG	1/4"	0.53"	0.44"	1.26"	0.99"	0.040"	0.135"	0.250"	50	500
MNG10-516R/SK	054007-01940	12 - 10 AWG	5/16"	0.53"	0.44"	1.26"	0.99"	0.040"	0.135"	0.250"	-	500
MNG10-516R/SX	051128-58984	12 - 10 AWG	5/16"	0.53"	0.44"	1.26"	0.99"	0.040"	0.135"	0.250"	50	500
MNG10-38R/SK	054007-01942	12 - 10 AWG	3/8"	0.54"	0.44"	1.26"	0.99"	0.040"	0.135"	0.250"	-	500
MNG10-38R/SX	051128-58985	12 - 10 AWG	3/8"	0.54"	0.44"	1.26"	0.99"	0.040"	0.135"	0.250"	50	500

Nylon Insulated Braze Seam Ring Tongues

Terminal Type Ring
Terminal Style Standard
Insulation Material Nylon
Barrel Style Braze
RoHS 2011/65/EU Yes

Agency Approval Except for MN24 Rings

Manufacturing Origin

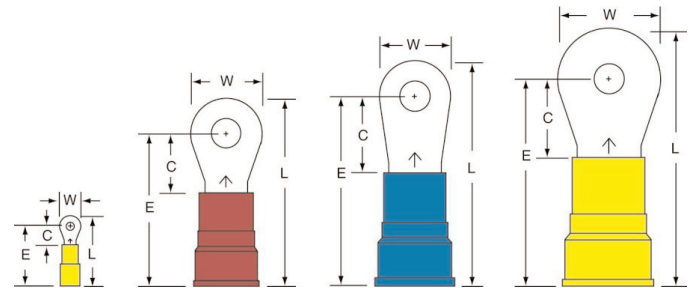

Order No.	UPC	Conductor Size	Stud Size	(W)	(C)	(L)	(E)	Thickness	Barrel I.D.	Max. Insul. Dia.	Terminals per Carton	Terminals per Case
MN4-10RK	054007-08277	4 AWG	10	0.68"	0.53"	1.74"	1.41"	0.075"	0.280"	0.515"	-	200
MN4-12R/SK	054007-08281	4 AWG	1/2"	0.68"	0.53"	1.74"	1.41"	0.075"	0.280"	0.515"	-	200
MN4-14RK	054007-08278	4 AWG	1/4"	0.68"	0.53"	1.74"	1.41"	0.075"	0.280"	0.515"	-	200
MN4-38RK	054007-08280	4 AWG	3/8"	0.68"	0.53"	1.74"	1.41"	0.075"	0.280"	0.515"	-	200
MN4-38RX	051128-59002	4 AWG	3/8"	0.68"	0.53"	1.74"	1.41"	0.075"	0.280"	0.515"	10	100
MN4-516RK	054007-08279	4 AWG	5/16"	0.68"	0.53"	1.74"	1.41"	0.075"	0.280"	0.515"	-	200
MN6-10R/SK	054007-08272	6 AWG	10	0.47"	0.52"	1.50"	1.27"	0.050"	0.250"	0.440"	-	200
MN6-12R/SK	054007-08276	6 AWG	1/2"	0.81"	0.63"	1.78"	1.38"	0.050"	0.250"	0.440"	-	200
MN6-14R/SX	051128-58637	6 AWG	1/4"	0.47"	0.52"	1.50"	1.27"	0.050"	0.250"	0.440"	10	100
MN6-14R/SK	054007-08273	6 AWG	1/4"	0.47"	0.52"	1.50"	1.27"	0.050"	0.250"	0.440"	-	200
MN6-38RK	054007-08275	6 AWG	3/8"	0.63"	0.52"	1.58"	1.27"	0.050"	0.250"	0.440"	-	200
MN6-38RX	051128-58878	6 AWG	3/8"	0.63"	0.52"	1.58"	1.27"	0.050"	0.250"	0.440"	10	100
MN6-516RK	054007-08274	6 AWG	5/16"	0.63"	0.52"	1.58"	1.27"	0.050"	0.250"	0.440"	-	200
MN8-10R/SK	054007-08267	8 AWG	10	0.47"	0.40"	1.26"	1.03"	0.050"	0.175"	0.340"	-	200
MN8-14R/SX	051128-58635	8 AWG	1/4"	0.47"	0.40"	1.26"	1.03"	0.050"	0.175"	0.340"	10	100
MN8-14R/SK	054007-08268	8 AWG	1/4"	0.47"	0.40"	1.26"	1.03"	0.050"	0.175"	0.340"	-	200
MN8-516RK	054007-08269	8 AWG	5/16"	0.59"	0.45"	1.38"	1.08"	0.050"	0.175"	0.340"	-	200
MN8-38RX	051128-58639	8 AWG	3/8"	0.59"	0.45"	1.38"	1.08"	0.050"	0.175"	0.340"	10	100

Nylon Insulated Brazed Seam Ring Tongues (continued)

Order No.	UPC	Conductor Size	Stud Size	(W)	(C)	(L)	(E)	Thickness	Barrel I.D.	Max. Insul. Dia.	Terminals per Carton	Terminals per Case
MN8-38RK	054007-08270	8 AWG	3/8"	0.59"	0.45"	1.38"	1.08"	0.050"	0.175"	0.340"	-	200
MN8-12R/SK	054007-08271	8 AWG	1/2"	0.81"	0.69"	1.72"	1.32"	0.050"	0.175"	0.340"	-	200
MN24-2RK	054007-95136	26-24 AWG	2	0.14"	0.12"	0.47"	0.40"	0.020"	0.030"	0.093"	1000	5000
MN24-4RK	054007-95142	26-24 AWG	4	0.20"	0.21"	0.60"	0.49"	0.020"	0.030"	0.093"	-	1000
MN24-6RK	054007-95146	26-24 AWG	6	0.20"	0.21"	0.60"	0.49"	0.020"	0.030"	0.093"	-	1000
MN24-8RK	054007-95161	26-24 AWG	8	0.25"	0.28"	0.69"	0.56"	0.020"	0.030"	0.093"	-	1000

Vinyl Insulated Brazed Seam Ring Tongues

Terminal Type Ring
Terminal Style Standard
Insulation Material Vinyl
Barrel Style Brazed
RoHS 2011/65/EU Yes
Agency Approval 
Manufacturing Origin 



Order No.	UPC	Conductor Size	Stud Size	(W)	(C)	(L)	(E)	Thickness	Barrel I.D.	Max. Insul. Dia.	Terminals per Carton	Terminals per Case
MV18-4R/SX	051128-58729	22 - 18 AWG	4	0.25"	0.22"	0.80"	0.67"	0.030"	0.070"	0.145"	100	500
MV18-4R/SK	054007-01046	22 - 18 AWG	4	0.25"	0.22"	0.80"	0.67"	0.030"	0.070"	0.145"	-	1000
MV18-6R/SX	051128-58730	22 - 18 AWG	6	0.25"	0.22"	0.80"	0.67"	0.030"	0.070"	0.145"	100	500
MV18-6R/SK	054007-01048	22 - 18 AWG	6	0.25"	0.22"	0.80"	0.67"	0.030"	0.070"	0.145"	-	1000
MV18-8R/LX	051128-58731	22 - 18 AWG	8	0.31"	0.33"	0.93"	0.78"	0.030"	0.070"	0.145"	100	500
MV18-8R/LK	054007-01053	22 - 18 AWG	8	0.31"	0.33"	0.93"	0.78"	0.030"	0.070"	0.145"	-	1000
MV18-10R/LX	051128-58732	22 - 18 AWG	10	0.31"	0.33"	0.93"	0.78"	0.030"	0.070"	0.145"	100	500
MV18-10R/LK	054007-01055	22 - 18 AWG	10	0.31"	0.33"	0.93"	0.78"	0.030"	0.070"	0.145"	-	1000
MV18-14R/SX	051128-58733	22 - 18 AWG	1/4"	0.47"	0.40"	1.08"	0.85"	0.030"	0.070"	0.145"	100	500
MV18-14R/SK	054007-01056	22 - 18 AWG	1/4"	0.47"	0.40"	1.08"	0.85"	0.030"	0.070"	0.145"	-	1000
MV18-516R/SX	051128-58942	22 - 18 AWG	5/16"	0.47"	0.40"	1.08"	0.85"	0.030"	0.070"	0.145"	100	500
MV18-38RX	051128-58734	22 - 18 AWG	3/8"	0.56"	0.40"	1.13"	0.85"	0.030"	0.070"	0.145"	100	500
MV14-4R/SX	051128-58752	16 - 14 AWG	4	0.25"	0.22"	0.80"	0.67"	0.030"	0.090"	0.170"	100	500
MV14-4R/SK	054007-01412	16 - 14 AWG	4	0.25"	0.22"	0.80"	0.67"	0.030"	0.090"	0.170"	-	1000
MV14-6R/SX	051128-58753	16 - 14 AWG	6	0.25"	0.22"	0.80"	0.67"	0.030"	0.090"	0.170"	100	500
MV14-6R/SK	054007-01414	16 - 14 AWG	6	0.25"	0.22"	0.80"	0.67"	0.030"	0.090"	0.170"	-	1000
MV14-8R/SK	054007-01417	16 - 14 AWG	8	0.25"	0.22"	0.80"	0.67"	0.030"	0.090"	0.170"	-	1000
MV14-8R/LX	051128-58755	16 - 14 AWG	8	0.31"	0.33"	0.93"	0.78"	0.030"	0.090"	0.170"	100	500
MV14-8R/LK	054007-01419	16 - 14 AWG	8	0.31"	0.33"	0.93"	0.78"	0.030"	0.090"	0.170"	-	1000
MV14-10RK	054007-01420	16 - 14 AWG	10	0.33"	0.29"	0.90"	0.74"	0.030"	0.090"	0.170"	-	1000
MV14-10R/LX	051128-58749	16 - 14 AWG	10	0.31"	0.33"	0.93"	0.78"	0.030"	0.090"	0.170"	100	500
MV14-10R/LK	054007-01421	16 - 14 AWG	10	0.31"	0.33"	0.93"	0.78"	0.030"	0.090"	0.170"	-	1000
MV14-14R/SX	051128-58750	16 - 14 AWG	1/4"	0.47"	0.40"	1.08"	0.85"	0.030"	0.090"	0.170"	100	500
MV14-14R/SK	054007-01422	16 - 14 AWG	1/4"	0.47"	0.40"	1.08"	0.85"	0.030"	0.090"	0.170"	-	1000
MV14-516R/SX	051128-58961	16 - 14 AWG	5/16"	0.47"	0.40"	1.08"	0.85"	0.030"	0.090"	0.170"	100	500

Vinyl Insulated Brazed Seam Ring Tongues (continued)

Order No.	UPC	Conductor Size	Stud Size	(W)	(C)	(L)	(E)	Thickness	Barrel I.D.	Max. Insul. Dia.	Terminals per Carton	Terminals per Case
MV14-516R/SK	054007-01424	16 - 14 AWG	5/16"	0.47"	0.40"	1.08"	0.85"	0.030"	0.090"	0.170"	-	1000
MV14-38RX	051128-58751	16 - 14 AWG	3/8"	0.56"	0.40"	1.13"	0.85"	0.030"	0.090"	0.170"	100	500
MV14-38RK	054007-00546	16 - 14 AWG	3/8"	0.56"	0.40"	1.13"	0.85"	0.030"	0.090"	0.170"	-	1000
MV10-4R/SK	054007-01918	12 - 10 AWG	4	0.28"	0.29"	0.98"	0.84"	0.040"	0.135"	0.250"	-	500
MV10-6RX	051128-58756	12 - 10 AWG	6	0.38"	0.29"	1.03"	0.84"	0.040"	0.135"	0.250"	50	500
MV10-6RK	054007-01920	12 - 10 AWG	6	0.38"	0.29"	1.03"	0.84"	0.040"	0.135"	0.250"	-	500
MV10-8RX	051128-58757	12 - 10 AWG	8	0.38"	0.29"	1.03"	0.84"	0.040"	0.135"	0.250"	50	500
MV10-8RK	054007-01922	12 - 10 AWG	8	0.38"	0.29"	1.03"	0.84"	0.040"	0.135"	0.250"	-	500
MV10-10RX	051128-58758	12 - 10 AWG	10	0.38"	0.29"	1.03"	0.84"	0.040"	0.135"	0.250"	50	500
MV10-10RK	054007-01923	12 - 10 AWG	10	0.38"	0.29"	1.03"	0.84"	0.040"	0.135"	0.250"	-	500
MV10-14R/SX	051128-58759	12 - 10 AWG	1/4"	0.53"	0.44"	1.26"	0.99"	0.040"	0.135"	0.250"	50	500
MV10-14R/SK	054007-01924	12 - 10 AWG	1/4"	0.53"	0.44"	1.26"	0.99"	0.040"	0.135"	0.250"	-	500
MV10-516R/SX	051128-58760	12 - 10 AWG	5/16"	0.53"	0.44"	1.26"	0.99"	0.040"	0.135"	0.250"	50	500
MV10-516R/SK	054007-01926	12 - 10 AWG	5/16"	0.53"	0.44"	1.26"	0.99"	0.040"	0.135"	0.250"	-	500
MV10-38R/SX	051128-58983	12 - 10 AWG	3/8"	0.54"	0.44"	1.26"	0.99"	0.040"	0.135"	0.250"	50	500
MV10-38R/SK	054007-01928	12 - 10 AWG	3/8"	0.54"	0.44"	1.26"	0.99"	0.040"	0.135"	0.250"	-	500
MV10-12RX	054007-23409	12 - 10 AWG	1/2"	0.75"	0.57"	1.50"	1.12"	0.040"	0.135"	0.250"	50	500
MV10-12RK	054007-01931	12 - 10 AWG	1/2"	0.75"	0.57"	1.50"	1.12"	0.040"	0.135"	0.250"	-	500

Vinyl Insulated Butted Seam Ring Tongues

- Terminal Type Ring
- Terminal Style Standard
- Insulation Material Vinyl
- Barrel Style Butted
- RoHS 2011/65/EU Yes
- Agency Approval 
- Manufacturing Origin 

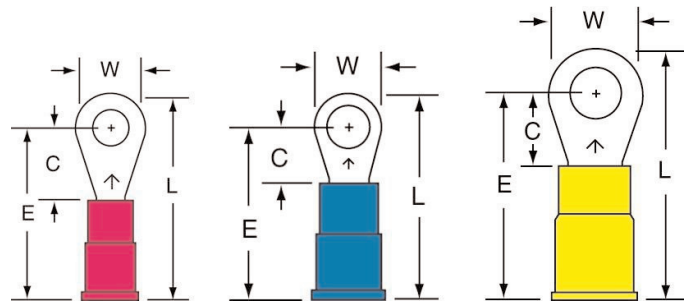

Order No.	UPC	Conductor Size	Stud Size	(W)	(C)	(L)	(E)	Thickness	Barrel I.D.	Max. Insul. Dia.	Terminals per Carton	Terminals per Case
MVU18-4R/SK	054007-01078	22 - 18 AWG	4	0.25"	0.22"	0.80"	0.67"	0.030"	0.070"	0.145"	-	1000
MVU18-6R/SK	054007-01080	22 - 18 AWG	6	0.25"	0.22"	0.80"	0.67"	0.030"	0.070"	0.145"	-	1000
MVU18-6R/SX	051128-58814	22 - 18 AWG	6	0.25"	0.22"	0.80"	0.67"	0.030"	0.070"	0.145"	100	500
MVU18-8R/LK	054007-01085	22 - 18 AWG	8	0.31"	0.33"	0.93"	0.78"	0.030"	0.070"	0.145"	-	1000
MVU18-8R/LX	051128-59040	22 - 18 AWG	8	0.31"	0.33"	0.93"	0.78"	0.030"	0.070"	0.145"	100	500
MVU18-8R/SX	051128-58852	22 - 18 AWG	8	0.25"	0.22"	0.80"	0.67"	0.030"	0.070"	0.145"	100	500
MVU18-10R/LK	054007-01087	22 - 18 AWG	10	0.31"	0.33"	0.93"	0.78"	0.030"	0.070"	0.145"	-	1000
MVU18-10R/LX	054007-35107	22 - 18 AWG	10	0.31"	0.33"	0.93"	0.78"	0.030"	0.070"	0.145"	50	500
MVU18-10RX	051128-58853	22 - 18 AWG	10	0.31"	0.29"	0.90"	0.74"	0.030"	0.070"	0.145"	100	500
MVU18-14R/SK	054007-01088	22 - 18 AWG	1/4"	0.47"	0.40"	1.08"	0.85"	0.030"	0.070"	0.145"	-	1000
MVU18-14R/SX	051128-58815	22 - 18 AWG	1/4"	0.47"	0.40"	1.08"	0.85"	0.030"	0.070"	0.145"	100	500
MVU18-516R/SK	054007-01090	22 - 18 AWG	5/16"	0.47"	0.40"	1.08"	0.85"	0.030"	0.070"	0.145"	-	1000
MVU18-38RK	054007-01092	22 - 18 AWG	3/8"	0.56"	0.40"	1.13"	0.85"	0.030"	0.070"	0.145"	-	1000

Terminals, Kits and Tools

3M™ Scotchlok™ Ring Tongues

Vinyl Insulated Butted Seam Ring Tongues (continued)

Order No.	UPC	Conductor Size	Stud Size	(W)	(C)	(L)	(E)	Thickness	Barrel I.D.	Max. Insul. Dia.	Terminals per Carton	Terminals per Case
MVU14-4R/SK	054007-01444	16 - 14 AWG	4	0.25"	0.22"	0.80"	0.67"	0.030"	0.070"	0.145"	-	1000
MVU14-6R/SK	054007-01446	16 - 14 AWG	6	0.25"	0.22"	0.80"	0.67"	0.030"	0.070"	0.145"	-	1000
MVU14-6R/SX	051128-58818	16 - 14 AWG	6	0.25"	0.22"	0.80"	0.67"	0.030"	0.070"	0.145"	100	500
MVU14-8RK	054007-01450	16 - 14 AWG	8	0.33"	0.29"	0.90"	0.74"	0.030"	0.070"	0.145"	-	1000
MVU14-8RX	051128-58880	16 - 14 AWG	8	0.33"	0.29"	0.90"	0.74"	0.030"	0.070"	0.145"	100	500
MVU14-8R/LK	054007-01451	16 - 14 AWG	8	0.31"	0.33"	0.93"	0.78"	0.030"	0.070"	0.145"	-	1000
MVU14-8R/SK	054007-01449	16 - 14 AWG	8	0.25"	0.22"	0.80"	0.67"	0.030"	0.070"	0.145"	-	1000
MVU14-8R/SX	051128-58887	16 - 14 AWG	8	0.25"	0.22"	0.80"	0.67"	0.030"	0.070"	0.145"	100	500
MVU14-10R/LK	054007-01453	16 - 14 AWG	10	0.31"	0.33"	0.93"	0.78"	0.030"	0.070"	0.145"	-	1000
MVU14-10RK	054007-01452	16 - 14 AWG	10	0.33"	0.29"	0.90"	0.74"	0.030"	0.070"	0.145"	-	1000
MVU14-10RX	051128-58819	16 - 14 AWG	10	0.33"	0.29"	0.90"	0.74"	0.030"	0.070"	0.145"	100	500
MVU14-14R/SK	054007-01454	16 - 14 AWG	1/4"	0.47"	0.40"	1.08"	0.85"	0.030"	0.070"	0.145"	-	1000
MVU14-14R/SX	051128-58820	16 - 14 AWG	1/4"	0.47"	0.40"	1.08"	0.85"	0.030"	0.070"	0.145"	100	500
MVU14-38RK	054007-01458	16 - 14 AWG	3/8"	0.56"	0.40"	1.13"	0.85"	0.030"	0.070"	0.145"	-	1000
MVU14-38R/SX	051128-58821	16 - 14 AWG	3/8"	-	-	-	-	0.030"	0.070"	0.145"	100	500
MVU14-516R/SK	054007-01456	16 - 14 AWG	5/16"	0.47"	0.40"	1.08"	0.85"	0.030"	0.070"	0.145"	-	1000
MVU10-4R/SK	054007-01946	12 - 10 AWG	4	0.28"	0.29"	0.98"	0.84"	0.040"	0.135"	0.250"	-	500
MVU10-6RK	054007-01948	12 - 10 AWG	6	0.38"	0.29"	1.03"	0.84"	0.040"	0.135"	0.250"	-	500
MVU10-6RX	051128-58854	12 - 10 AWG	6	0.38"	0.29"	1.03"	0.84"	0.040"	0.135"	0.250"	50	500
MVU10-8RK	054007-01950	12 - 10 AWG	8	0.38"	0.29"	1.03"	0.84"	0.040"	0.135"	0.250"	-	500
MVU10-8RX	051128-58879	12 - 10 AWG	8	0.38"	0.29"	1.03"	0.84"	0.040"	0.135"	0.250"	50	500
MVU10-8R/SX	051128-58881	12 - 10 AWG	8	0.28"	0.29"	0.98"	0.84"	0.040"	0.135"	0.250"	50	500
MVU10-10RK	054007-01951	12 - 10 AWG	10	0.38"	0.29"	1.03"	0.84"	0.040"	0.135"	0.250"	-	500
MVU10-10RX	051128-58824	12 - 10 AWG	10	0.38"	0.29"	1.03"	0.84"	0.040"	0.135"	0.250"	50	500
MVU10-14R/SK	054007-01952	12 - 10 AWG	1/4"	0.53"	0.44"	1.26"	0.99"	0.040"	0.135"	0.250"	-	500
MVU10-14R/SX	051128-58825	12 - 10 AWG	1/4"	0.53"	0.44"	1.26"	0.99"	0.040"	0.135"	0.250"	50	500
MVU10-38R/SK	054007-01956	12 - 10 AWG	3/8"	0.54"	0.44"	1.26"	0.99"	0.040"	0.135"	0.250"	-	500
MVU10-38R/SX	051128-58882	12 - 10 AWG	3/8"	0.54"	0.44"	1.26"	0.99"	0.040"	0.135"	0.250"	50	500
MVU10-38RX	051128-58826	12 - 10 AWG	3/8"	0.59"	0.44"	1.29"	0.99"	0.040"	0.135"	0.250"	50	500
MVU10-516R/SK	054007-01954	12 - 10 AWG	5/16"	0.53"	0.44"	1.26"	0.99"	0.040"	0.135"	0.250"	-	500

Non-Insulated Brazed Seam Ring Tongues

Terminal Type Ring
 Terminal Style Standard
 Insulation Material Non-Insulated
 Barrel Style Brazed
 RoHS 2011/65/EU Yes

Agency Approval



Manufacturing Origin



Order No.	UPC	Conductor Size	Stud Size	(W)	(C)	(L)	(E)	Thickness	Barrel I.D.	Terminals per Carton	Terminals per Case
M18-4R/SX	051128-58939	22 - 18 AWG	4	0.25"	0.22"	0.60"	0.47"	0.030"	0.070"	100	500
M18-6R/SK	054007-01016	22 - 18 AWG	6	0.25"	0.22"	0.60"	0.47"	0.030"	0.070"	-	1000
M18-6R/SX	051128-58640	22 - 18 AWG	6	0.25"	0.22"	0.60"	0.47"	0.030"	0.070"	100	500
M18-8R/LX	051128-58656	22 - 18 AWG	8	0.31"	0.33"	0.74"	0.58"	0.030"	0.070"	100	500
M18-8R/LK	054007-01021	22 - 18 AWG	8	0.31"	0.33"	0.74"	0.58"	0.030"	0.070"	-	1000
M18-10R/LX	051128-58641	22 - 18 AWG	10	0.31"	0.33"	0.74"	0.58"	0.030"	0.070"	100	500
M18-10R/LK	054007-01023	22 - 18 AWG	10	0.31"	0.33"	0.74"	0.58"	0.030"	0.070"	-	1000
M18-14R/SX	051128-58940	22 - 18 AWG	1/4"	0.47"	0.40"	0.89"	0.65"	0.030"	0.070"	100	500
M18-38RX	051128-58941	22 - 18 AWG	3/8"	0.56"	0.40"	0.93"	0.65"	0.030"	0.070"	100	500
M14-4R/SX	051128-58959	16 - 14 AWG	4	0.25"	0.22"	0.60"	0.47"	0.030"	0.090"	100	500
M14-6R/SK	054007-01382	16 - 14 AWG	6	0.25"	0.22"	0.60"	0.47"	0.030"	0.090"	-	1000
M14-6R/SX	051128-58658	16 - 14 AWG	6	0.25"	0.22"	0.60"	0.47"	0.030"	0.090"	100	500
M14-6R/LK	054007-01384	16 - 14 AWG	6	0.31"	0.33"	0.74"	0.58"	0.030"	0.090"	-	1000
M14-8R/LK	054007-13880	16 - 14 AWG	8	0.31"	0.33"	0.74"	0.58"	0.030"	0.090"	-	1000
M14-8R/LX	051128-58710	16 - 14 AWG	8	0.31"	0.33"	0.74"	0.58"	0.030"	0.090"	100	500
M14-10RK	054007-13929	16 - 14 AWG	10	0.33"	0.29"	0.70"	0.54"	0.030"	0.090"	-	1000
M14-10R/LK	054007-01389	16 - 14 AWG	10	0.31"	0.33"	0.74"	0.58"	0.030"	0.090"	-	1000
M14-10R/LX	051128-58659	16 - 14 AWG	10	0.31"	0.33"	0.74"	0.58"	0.030"	0.090"	100	500
M14-14R/SK	054007-01390	16 - 14 AWG	1/4"	0.47"	0.40"	0.89"	0.65"	0.030"	0.090"	-	1000
M14-14R/SX	051128-58660	16 - 14 AWG	1/4"	0.47"	0.40"	0.89"	0.65"	0.030"	0.090"	100	500
M14-38RX	051128-58960	16 - 14 AWG	3/8"	0.56"	0.40"	0.93"	0.65"	0.030"	0.090"	100	500
M14-516R/SK	054007-01392	16 - 14 AWG	5/16"	0.47"	0.40"	0.89"	0.65"	0.030"	0.090"	-	1000
M10-4R/SK	054007-01890	12 - 10 AWG	4	0.28"	0.29"	0.68"	0.54"	0.040"	0.135"	-	500
M10-6RX	051128-58681	12 - 10 AWG	6	0.38"	0.29"	0.73"	0.54"	0.040"	0.135"	50	500
M10-6RK	054007-01892	12 - 10 AWG	6	0.38"	0.29"	0.73"	0.54"	0.040"	0.135"	-	500
M10-8RX	051128-58714	12 - 10 AWG	8	0.38"	0.29"	0.73"	0.54"	0.040"	0.135"	50	500
M10-8RK	054007-01894	12 - 10 AWG	8	0.38"	0.29"	0.73"	0.54"	0.040"	0.135"	-	500
M10-10RX	051128-58682	12 - 10 AWG	10	0.38"	0.29"	0.73"	0.54"	0.040"	0.135"	50	500
M10-10RK	054007-14002	12 - 10 AWG	10	0.38"	0.29"	0.73"	0.54"	0.040"	0.135"	-	500
M10-14R/SX	051128-58683	12 - 10 AWG	1/4"	0.54"	0.44"	0.96"	0.69"	0.040"	0.135"	50	500
M10-14R/SK	054007-01896	12 - 10 AWG	1/4"	0.54"	0.44"	0.96"	0.69"	0.040"	0.135"	-	500
M10-516R/SX	051128-58981	12 - 10 AWG	5/16"	0.54"	0.44"	0.96"	0.69"	0.040"	0.135"	100	500
M10-38R/SX	051128-58982	12 - 10 AWG	3/8"	0.54"	0.44"	0.96"	0.69"	0.040"	0.135"	50	500
M10-38R/SK	054007-01900	12 - 10 AWG	3/8"	0.54"	0.44"	0.96"	0.69"	0.040"	0.135"	-	500
M10-12RK	054007-01903	12 - 10 AWG	1/2"	0.75"	0.57"	1.19"	0.82"	0.040"	0.135"	-	500
M8-10R/SX	051128-58693	8 AWG	10	0.47"	0.40"	0.95"	0.72"	0.050"	0.175"	10	100

Non-Insulated Brazed Seam Ring Tongues (continued)

Order No.	UPC	Conductor Size	Stud Size	(W)	(C)	(L)	(E)	Thickness	Barrel I.D.	Terminals per Carton	Terminals per Case
M8-10R/SK	054007-02118	8 AWG	10	0.47"	0.40"	0.95"	0.72"	0.050"	0.175"	-	200
M8-14R/SX	051128-58694	8 AWG	1/4"	0.47"	0.40"	0.95"	0.72"	0.050"	0.175"	10	100
M8-14R/SK	054007-02120	8 AWG	1/4"	0.47"	0.40"	0.95"	0.72"	0.050"	0.175"	-	200
M8-516RX	051128-58695	8 AWG	5/16"	0.59"	0.45"	1.06"	0.77"	0.050"	0.175"	10	100
M8-516RK	054007-02122	8 AWG	5/16"	0.59"	0.45"	1.06"	0.77"	0.050"	0.175"	-	200
M8-38RX	051128-58696	8 AWG	3/8"	0.59"	0.45"	1.06"	0.77"	0.050"	0.175"	10	100
M8-38RK	054007-02123	8 AWG	3/8"	0.59"	0.45"	1.06"	0.77"	0.050"	0.175"	-	200
M8-12R/SK	054007-02126	8 AWG	1/2"	0.81"	0.69"	1.41"	1.00"	0.050"	0.175"	-	200
M6-10R/SX	051128-58697	6 AWG	10	0.47"	0.52"	1.14"	0.91"	0.050"	0.250"	10	100
M6-10R/SK	054007-02147	6 AWG	10	0.47"	0.52"	1.14"	0.91"	0.050"	0.250"	-	200
M6-14R/SX	051128-58698	6 AWG	1/4"	0.47"	0.52"	1.14"	0.91"	0.050"	0.250"	10	100
M6-14R/SK	054007-02149	6 AWG	1/4"	0.47"	0.52"	1.14"	0.91"	0.050"	0.250"	-	200
M6-516RX	051128-58699	6 AWG	5/16"	0.63"	0.52"	1.22"	0.91"	0.050"	0.250"	10	100
M6-516RK	054007-02151	6 AWG	5/16"	0.63"	0.52"	1.22"	0.91"	0.050"	0.250"	-	200
M6-38RX	051128-58700	6 AWG	3/8"	0.63"	0.52"	1.22"	0.91"	0.050"	0.250"	10	100
M6-38RK	054007-02152	6 AWG	3/8"	0.63"	0.52"	1.22"	0.91"	0.050"	0.250"	-	200
M6-12R/SK	054007-02155	6 AWG	1/2"	0.81"	0.63"	1.42"	1.02"	0.050"	0.250"	-	200
M4-10RX	051128-58992	4 AWG	10	0.68"	0.53"	1.34"	1.00"	0.075"	0.280"	10	100
M4-14RX	051128-58701	4 AWG	1/4"	0.68"	0.53"	1.34"	1.00"	0.075"	0.280"	10	100
M4-14RK	054007-02177	4 AWG	1/4"	0.68"	0.53"	1.34"	1.00"	0.075"	0.280"	-	200
M4-516RX	051128-58702	4 AWG	5/16"	0.68"	0.53"	1.34"	1.00"	0.075"	0.280"	10	100
M4-516RK	054007-02178	4 AWG	5/16"	0.68"	0.53"	1.34"	1.00"	0.075"	0.280"	-	200
M4-38RX	051128-58703	4 AWG	3/8"	0.68"	0.53"	1.34"	1.00"	0.075"	0.280"	10	100
M4-38RK	054007-02179	4 AWG	3/8"	0.68"	0.53"	1.34"	1.00"	0.075"	0.280"	-	200
M4-12R/SK	054007-02182	4 AWG	1/2"	0.68"	0.53"	1.34"	1.00"	0.075"	0.280"	-	200

3M™ Scotchlok™ Ring Tongues

Non-Insulated Butted Seam Ring Tongues

Terminal Type Ring
 Terminal Style Standard
 Insulation Material Non-Insulated
 Barrel Style Butted
 RoHS 2011/65/EU Yes

Agency Approval



Manufacturing Origin



Order No.	UPC	Conductor Size	Stud Size	(W)	(C)	(L)	(E)	Thickness	Barrel I.D.	Terminals per Carton	Terminals per Case
MU18-4R/SK	054007-00998	22 - 18 AWG	4	0.25"	0.22"	0.60"	0.47"	0.030"	0.070"	-	1000
MU18-6R/SK	054007-01000	22 - 18 AWG	6	0.25"	0.22"	0.60"	0.47"	0.030"	0.070"	-	1000
MU18-8R/LK	054007-01005	22 - 18 AWG	8	0.31"	0.33"	0.74"	0.58"	0.030"	0.070"	-	1000
MU18-8RLX	051128-59037	22 - 18 AWG	8	0.31"	0.33"	0.74"	0.58"	0.030"	0.070"	100	500
MU18-10R/LK	054007-01007	22 - 18 AWG	10	0.31"	0.33"	0.74"	0.58"	0.030"	0.070"	-	1000
MU18-10RX	051128-59004	22 - 18 AWG	10	0.33"	0.29"	0.70"	0.54"	0.030"	0.070"	100	500
MU18-14R/SK	054007-01008	22 - 18 AWG	1/4"	0.47"	0.40"	0.89"	0.65"	0.030"	0.070"	-	1000
MU18-38RK	054007-01012	22 - 18 AWG	3/8"	0.56"	0.40"	0.93"	0.65"	0.030"	0.070"	-	1000
MU14-4R/SK	054007-01364	16 - 14 AWG	4	0.25"	0.22"	0.60"	0.47"	0.030"	0.090"	-	1000
MU14-6R/SK	054007-01366	16 - 14 AWG	6	0.25"	0.22"	0.60"	0.47"	0.030"	0.090"	-	1000
MU14-8R/LK	054007-01371	16 - 14 AWG	8	0.25"	0.22"	0.74"	0.58"	0.030"	0.090"	-	1000
MU14-8RLX	051128-59038	16 - 14 AWG	8	0.25"	0.22"	0.74"	0.58"	0.030"	0.090"	100	500
MU14-10R/LK	054007-01373	16 - 14 AWG	10	0.31"	0.33"	0.74"	0.58"	0.030"	0.090"	-	1000
MU14-10RK	054007-01372	16 - 14 AWG	10	0.33"	0.29"	0.70"	0.54"	0.030"	0.090"	-	1000
MU14-10RX	051128-59005	16 - 14 AWG	10	0.33"	0.29"	0.70"	0.54"	0.030"	0.090"	100	500
MU14-14R/SK	054007-01374	16 - 14 AWG	1/4"	0.47"	0.40"	0.89"	0.65"	0.030"	0.090"	-	1000
MU10-4R/SK	054007-01876	12 - 10 AWG	4	0.28"	0.29"	0.68"	0.54"	0.040"	0.135"	-	500
MU10-6RK	054007-01878	12 - 10 AWG	6	0.38"	0.29"	0.73"	0.54"	0.040"	0.135"	-	500
MU10-6RX	051128-58857	12 - 10 AWG	6	0.38"	0.29"	0.73"	0.54"	0.040"	0.135"	50	500
MU10-8RK	054007-01880	12 - 10 AWG	8	0.38"	0.29"	0.73"	0.54"	0.040"	0.135"	-	500
MU10-8RX	051128-59039	12 - 10 AWG	8	0.38"	0.29"	0.73"	0.54"	0.040"	0.135"	100	500
MU10-10RK	054007-01881	12 - 10 AWG	10	0.38"	0.29"	0.73"	0.54"	0.040"	0.135"	-	500
MU10-14R/SK	054007-01882	12 - 10 AWG	1/4"	0.53"	0.44"	0.96"	0.69"	0.040"	0.135"	-	500

Nylon Insulated with Insulation Grip Multi-Stud Ring Tongues

Terminal Type Ring
 Terminal Style Multi-Stud
 Insulation Material Nylon with Insulation Grip
 Barrel Style Butted
 RoHS 2011/65/EU Yes
 Agency Approval 
 Manufacturing Origin  With U.S. and Global Content



Order No.	UPC	Conductor Size	Stud Size	(W)	(C)	(L)	(E)	Thickness	Barrel I.D.	Max. Insul. Dia.	Terminals per Carton	Terminals per Case
MNG18-610RX	051128-58958	22 - 18 AWG	6 - 10	0.34"	0.31"	1.00"	0.75"	0.030"	0.070"	0.145"	100	500
MNG14-610RX	051128-58980	16 - 14 AWG	6 - 10	0.34"	0.31"	1.02"	0.77"	0.030"	0.090"	0.170"	100	500
MNG10-610RX	051128-58990	12 - 10 AWG	6 - 10	0.39"	0.35"	1.19"	0.80"	0.040"	0.135"	0.250"	50	500

Vinyl Insulated Brazed Seam Multi-Stud Ring Tongues

Terminal Type Ring
 Terminal Style Multi-Stud
 Insulation Material Vinyl
 Barrel Style Brazed
 RoHS 2011/65/EU Yes
 Agency Approval 
 Manufacturing Origin 



Order No.	UPC	Conductor Size	Stud Size	(W)	(C)	(L)	(E)	Thickness	Barrel I.D.	Max. Insul. Dia.	Terminals per Carton	Terminals per Case
MV18-610RK	054007-01342	22 - 18 AWG	6 - 10	0.34"	0.31"	1.01"	0.76"	0.030"	0.070"	0.145"	-	1000
MV18-610RX	051128-58768	22 - 18 AWG	6 - 10	0.34"	0.31"	1.01"	0.76"	0.030"	0.070"	0.145"	100	500
MV14-610RK	054007-01851	16 - 14 AWG	6 - 10	0.34"	0.31"	1.01"	0.76"	0.030"	0.090"	0.170"	-	1000
MV14-610RX	051128-58769	16 - 14 AWG	6 - 10	0.34"	0.31"	1.01"	0.76"	0.030"	0.090"	0.170"	100	500
MV10-610RK	054007-02099	12 - 10 AWG	6 - 10	0.39"	0.35"	1.19"	0.80"	0.040"	0.135"	0.250"	-	500
MV10-610RX	051128-58770	12 - 10 AWG	6 - 10	0.39"	0.35"	1.19"	0.80"	0.040"	0.135"	0.250"	50	500

Non-Insulated Copper Seamless Compression Lug Ring Tongues

Terminal Type Ring
 Terminal Style Compression Lug
 Insulation Material Non-Insulated
 Barrel Style Seamless
 RoHS 2011/65/EU Yes

Agency Approval



Manufacturing Origin

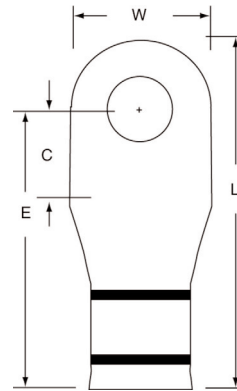

Order No.	UPC	Conductor Size	Stud Size	Color Code	(W)	(C)	(L)	Thickness	Barrel I.D.	Terminals per Carton	Terminals per Case
MC2-14RX	054007-09187	2 AWG	1/4"	Brown	0.65"	0.41"	1.69"	0.100"	0.340"	10	100
MC2-38RX	054007-09189	2 AWG	3/8"	Brown	0.65"	0.41"	1.69"	0.100"	0.340"	10	100
MC2-516RX	054007-09188	2 AWG	5/16"	Brown	0.65"	0.41"	1.69"	0.100"	0.340"	10	100
MC1-14RX	054007-09190	1 AWG	1/4"	Green	0.65"	0.43"	1.71"	0.100"	0.360"	10	100
MC1-516RX	054007-09191	1 AWG	5/16"	Green	0.65"	0.43"	1.71"	0.100"	0.360"	10	100
MC1-38RX	054007-09192	1 AWG	3/8"	Green	0.68"	0.43"	1.71"	0.100"	0.360"	10	100
MC1/0-14RX	054007-09193	1/0 AWG	1/4"	Pink	0.75"	0.38"	1.84"	0.100"	0.410"	10	100
MC1/0-38RX	054007-09194	1/0 AWG	3/8"	Pink	0.75"	0.42"	1.84"	0.100"	0.410"	10	100
MC1/0-12RX	054007-09195	1/0 AWG	1/2"	Pink	0.75"	0.42"	1.84"	0.100"	0.410"	10	100
MC2/0-38RX	054007-09197	2/0 AWG	3/8"	Black	0.83"	0.48"	2.05"	0.100"	0.460"	10	100
MC2/0-12RX	054007-09198	2/0 AWG	1/2"	Black	0.83"	0.48"	2.05"	0.100"	0.460"	10	100
MC3/0-38RX	054007-09199	3/0 AWG	3/8"	Orange	0.91"	0.50"	2.24"	0.120"	0.510"	6	60
MC3/0-12RX	054007-09200	3/0 AWG	1/2"	Orange	0.91"	0.50"	2.24"	0.120"	0.510"	6	60
MC4/0-12RX	054007-09202	4/0 AWG	1/2"	Purple	1.00"	0.52"	2.29"	0.125"	0.560"	6	60
MC4/0-38RX	054007-09201	4/0 AWG	3/8"	Purple	1.00"	0.52"	2.29"	0.125"	0.560"	6	60
MC250-12RX	054007-09204	250 kcmil	1/2"	Yellow	1.13"	0.60"	2.43"	0.140"	0.630"	6	60
MC250-38RX	054007-09203	250 kcmil	3/8"	Yellow	1.13"	0.60"	2.43"	0.140"	0.630"	6	60

Nylon Insulated with Insulation Grip Standard Forks

Terminal Type Fork
 Terminal Style Standard
 Insulation Material Nylon with Insulation Grip
 Barrel Style Butted
 RoHS 2011/65/EU Yes
 Agency Approval 

Manufacturing Origin 
 With U.S. and Global Content



Order No.	UPC	Conductor Size	Stud Size	(W)	(C)	(L)	(E)	Thickness	Barrel I.D.	Max. Insul. Dia.	Terminals per Carton	Terminals per Case
MNG18-6FX	051128-58650	22 - 18 AWG	6	0.34"	0.29"	0.89"	0.73"	0.030"	0.070"	0.145"	100	500
MNG18-8FX	051128-58651	22 - 18 AWG	8	0.34"	0.29"	0.89"	0.73"	0.030"	0.070"	0.145"	100	500
MNG18-10FX	051128-58858	22 - 18 AWG	10	0.34"	0.29"	0.89"	0.73"	0.030"	0.070"	0.145"	100	500
MNG14-6FX	051128-58665	16 - 14 AWG	6	0.34"	0.29"	0.91"	0.75"	0.030"	0.070"	0.145"	100	500
MNG14-8FK	054007-01536	16 - 14 AWG	8	0.34"	0.29"	0.91"	0.75"	0.030"	0.070"	0.145"	-	1000
MNG14-8FX	051128-58666	16 - 14 AWG	8	0.34"	0.29"	0.91"	0.75"	0.030"	0.070"	0.145"	100	500
MNG14-10FK	054007-01538	16 - 14 AWG	10	0.34"	0.29"	0.91"	0.75"	0.030"	0.070"	0.145"	-	1000
MNG14-10FX	051128-58667	16 - 14 AWG	10	0.34"	0.29"	0.91"	0.75"	0.030"	0.070"	0.145"	100	500
MNG10-6FX	051128-58859	12 - 10 AWG	6	0.38"	0.29"	1.03"	0.84"	0.040"	0.135"	0.250"	50	500
MNG10-8FK	054007-01982	12 - 10 AWG	8	0.38"	0.29"	1.03"	0.84"	0.040"	0.135"	0.250"	-	500
MNG10-8FX	051128-58688	12 - 10 AWG	8	0.38"	0.29"	1.03"	0.84"	0.040"	0.135"	0.250"	50	500
MNG10-10FK	054007-01983	12 - 10 AWG	10	0.38"	0.29"	1.03"	0.84"	0.040"	0.135"	0.250"	-	500
MNG10-10FX	051128-58717	12 - 10 AWG	10	0.38"	0.29"	1.03"	0.84"	0.040"	0.135"	0.250"	50	500

Vinyl Insulated Brazen Seam Standard Forks

Terminal Type Fork
 Terminal Style Standard
 Insulation Material Vinyl
 Barrel Style Brazen
 RoHS 2011/65/EU Yes



Order No.	UPC	Conductor Size	Stud Size	(W)	(C)	(L)	(E)	Thickness	Barrel I.D.	Max. Insul. Dia.	Terminals per Carton	Terminals per Case
MV18-6FX	051128-58735	22 - 18 AWG	6	0.34"	0.29"	0.90"	0.74"	0.030"	0.070"	0.145"	100	500
MV18-6FK	054007-01162	22 - 18 AWG	6	0.34"	0.29"	0.90"	0.74"	0.030"	0.070"	0.145"	-	1000
MV18-8FX	051128-58736	22 - 18 AWG	8	0.34"	0.29"	0.90"	0.74"	0.030"	0.070"	0.145"	100	500
MV18-8FK	054007-01164	22 - 18 AWG	8	0.34"	0.29"	0.90"	0.74"	0.030"	0.070"	0.145"	-	1000
MV18-10FX	051128-58737	22 - 18 AWG	10	0.34"	0.29"	0.90"	0.74"	0.030"	0.070"	0.145"	100	500
MV14-6FX	051128-58738	16 - 14 AWG	6	0.34"	0.29"	0.90"	0.74"	0.030"	0.090"	0.170"	100	500
MV14-6FK	054007-01528	16 - 14 AWG	6	0.34"	0.29"	0.90"	0.74"	0.030"	0.090"	0.170"	-	1000
MV14-8FX	051128-58741	16 - 14 AWG	8	0.34"	0.29"	0.90"	0.74"	0.030"	0.090"	0.170"	100	500
MV14-8FK	054007-01530	16 - 14 AWG	8	0.34"	0.29"	0.90"	0.74"	0.030"	0.090"	0.170"	-	1000
MV14-10FX	051128-58742	16 - 14 AWG	10	0.34"	0.29"	0.90"	0.74"	0.030"	0.090"	0.170"	100	500
MV14-10FK	054007-01532	16 - 14 AWG	10	0.34"	0.29"	0.90"	0.74"	0.030"	0.090"	0.170"	-	1000
MV10-6FX	051128-58761	12 - 10 AWG	6	0.38"	0.29"	1.03"	0.84"	0.040"	0.135"	0.250"	50	500
MV10-8FX	051128-58762	12 - 10 AWG	8	0.38"	0.29"	1.03"	0.84"	0.040"	0.135"	0.250"	50	500
MV10-8FK	054007-01979	12 - 10 AWG	8	0.38"	0.29"	1.03"	0.84"	0.040"	0.135"	0.250"	-	500
MV10-10FX	051128-58763	12 - 10 AWG	10	0.38"	0.29"	1.03"	0.84"	0.040"	0.135"	0.250"	50	500
MV10-10FK	054007-01980	12 - 10 AWG	10	0.38"	0.29"	1.03"	0.84"	0.040"	0.135"	0.250"	-	500

Vinyl Insulated Butted Seam Standard Forks

Terminal Type Fork
 Terminal Style Standard
 Insulation Material Vinyl
 Barrel Style Butted
 RoHS 2011/65/EU Yes

Agency Approval



Manufacturing Origin



Order No.	UPC	Conductor Size	Stud Size	(W)	(C)	(L)	(E)	Thickness	Barrel I.D.	Max. Insul. Dia.	Terminals per Carton	Terminals per Case
MVU18-6FK	054007-01174	22 - 18 AWG	6	0.34"	0.29"	0.90"	0.74"	0.030"	0.070"	0.145"	-	1000
MVU18-6FX	051128-59026	22 - 18 AWG	6	0.34"	0.29"	0.90"	0.74"	0.030"	0.070"	0.145"	100	500
MVU18-8FK	054007-01176	22 - 18 AWG	8	0.34"	0.29"	0.90"	0.74"	0.030"	0.070"	0.145"	-	1000
MVU18-8FX	051128-59027	22 - 18 AWG	8	0.34"	0.29"	0.90"	0.74"	0.030"	0.070"	0.145"	100	500
MVU18-10FK	054007-01178	22 - 18 AWG	10	0.34"	0.29"	0.90"	0.74"	0.030"	0.070"	0.145"	-	1000
MVU18-10FX	051128-59028	22 - 18 AWG	10	0.34"	0.29"	0.90"	0.74"	0.030"	0.070"	0.145"	100	500
MVU14-6FK	054007-01540	16 - 14 AWG	6	0.34"	0.29"	0.90"	0.74"	0.030"	0.090"	0.170"	-	1000
MVU14-6FX	051128-59029	16 - 14 AWG	6	0.34"	0.29"	0.90"	0.74"	0.030"	0.090"	0.170"	100	500
MVU14-8FK	054007-01542	16 - 14 AWG	8	0.34"	0.29"	0.90"	0.74"	0.030"	0.090"	0.170"	-	1000
MVU14-8FX	051128-59030	16 - 14 AWG	8	0.34"	0.29"	0.90"	0.74"	0.030"	0.090"	0.170"	100	500
MVU14-10FK	054007-01544	16 - 14 AWG	10	0.34"	0.29"	0.90"	0.74"	0.030"	0.090"	0.170"	-	1000
MVU14-10FX	051128-58883	16 - 14 AWG	10	0.34"	0.29"	0.90"	0.74"	0.030"	0.090"	0.170"	100	500
MVU10-6FK	054007-01984	12 - 10 AWG	6	0.38"	0.29"	1.03"	0.84"	0.030"	0.135"	0.250"	-	500
MVU10-6FX	051128-58856	12 - 10 AWG	6	0.38"	0.29"	1.03"	0.84"	0.030"	0.135"	0.250"	50	500
MVU10-8FK	054007-01985	12 - 10 AWG	8	0.38"	0.29"	1.03"	0.84"	0.030"	0.135"	0.250"	-	500
MVU10-8FX	051128-59031	12 - 10 AWG	8	0.38"	0.29"	1.03"	0.84"	0.030"	0.135"	0.250"	50	500
MVU10-10FK	054007-01986	12 - 10 AWG	10	0.38"	0.29"	1.03"	0.84"	0.030"	0.135"	0.250"	-	500
MVU10-10FX	051128-58884	12 - 10 AWG	10	0.38"	0.29"	1.03"	0.84"	0.030"	0.135"	0.250"	50	500

Non-Insulated Brazed Seam Standard Forks

Terminal Type	Fork
Terminal Style	Standard
Insulation Material	Non-Insulated
Barrel Style	Brazed
RoHS 2011/65/EU	Yes
Agency Approval	 
Manufacturing Origin	



Order No.	UPC	Conductor Size	Stud Size	(W)	(C)	(L)	(E)	Thickness	Barrel I.D.	Terminals per Carton	Terminals per Case
M18-6FX	051128-58655	22 - 18 AWG	6	0.34"	0.29"	0.70"	0.54"	0.030"	0.070"	100	500
M18-8FX	051128-58657	22 - 18 AWG	8	0.34"	0.29"	0.70"	0.54"	0.030"	0.070"	100	500
M18-10FX	051128-58947	22 - 18 AWG	10	0.34"	0.29"	0.70"	0.54"	0.030"	0.070"	100	500
M14-6FX	051128-59024	16 - 14 AWG	6	0.34"	0.29"	0.70"	0.54"	0.030"	0.090"	100	500
M14-8FX	051128-59025	16 - 14 AWG	8	0.34"	0.29"	0.70"	0.54"	0.030"	0.090"	100	500
M14-10FX	051128-58664	16 - 14 AWG	10	0.34"	0.29"	0.70"	0.54"	0.030"	0.090"	100	500
M14-10FK	054007-01520	16 - 14 AWG	10	0.34"	0.29"	0.70"	0.54"	0.030"	0.090"	-	1000
M10-6FX	051128-58861	12 - 10 AWG	6	0.38"	0.29"	0.73"	0.54"	0.040"	0.135"	50	500
M10-6FK	054007-01972	12 - 10 AWG	6	0.38"	0.29"	0.73"	0.54"	0.040"	0.135"	-	500
M10-8FX	051128-58716	12 - 10 AWG	8	0.38"	0.29"	0.73"	0.54"	0.040"	0.135"	50	500
M10-8FK	054007-01973	12 - 10 AWG	8	0.38"	0.29"	0.73"	0.54"	0.040"	0.135"	-	500
M10-10FX	051128-58687	12 - 10 AWG	10	0.38"	0.29"	0.73"	0.54"	0.040"	0.135"	50	500
M10-10FK	054007-01974	12 - 10 AWG	10	0.38"	0.29"	0.73"	0.54"	0.040"	0.135"	-	500

Non-Insulated Butted Seam Standard Forks

Terminal Type	Fork
Terminal Style	Standard
Insulation Material	Non-Insulated
Barrel Style	Butted
RoHS 2011/65/EU	Yes
Agency Approval	 
Manufacturing Origin	



Order No.	UPC	Conductor Size	Stud Size	(W)	(C)	(L)	(E)	Thickness	Barrel I.D.	Terminals per Carton	Terminals per Case
MU18-6FK	054007-01144	22 - 18 AWG	6	0.34"	0.29"	0.70"	0.54"	0.030"	0.070"	-	1000
MU14-10FK	054007-01514	16 - 14 AWG	10	0.34"	0.29"	0.70"	0.54"	0.030"	0.090"	-	1000
MU10-10FK	054007-01971	12 - 10 AWG	10	0.38"	0.29"	0.73"	0.54"	0.040"	0.135"	-	500

Nylon Insulated with Insulation Grip Block Forks

Terminal Type Fork
 Terminal Style Block
 Insulation Material Nylon with Insulation Grip
 Barrel Style Butted
 RoHS 2011/65/EU Yes

Agency Approval



Manufacturing Origin



Order No.	UPC	Conductor Size	Stud Size	(W)	(C)	(L)	(E)	Thickness	Barrel I.D.	Max. Insul. Dia.	Terminals per Carton	Terminals per Case
MNG18-4FB/SK	054007-02261	22 - 18 AWG	4	0.25"	0.25"	0.84"	0.69"	0.030"	0.070"	0.145"	-	1000
MNG18-6FB/SX	051128-58951	22 - 18 AWG	6	0.25"	0.25"	0.84"	0.69"	0.030"	0.070"	0.145"	100	500
MNG18-6FB/SK	054007-01214	22 - 18 AWG	6	0.25"	0.25"	0.84"	0.69"	0.030"	0.070"	0.145"	-	1000
MNG18-6FBX	051128-58652	22 - 18 AWG	6	0.30"	0.25"	0.84"	0.69"	0.030"	0.070"	0.145"	100	500
MNG18-6FBK	054007-01215	22 - 18 AWG	6	0.30"	0.25"	0.84"	0.69"	0.030"	0.070"	0.145"	-	1000
MNG18-8FBX	051128-58653	22 - 18 AWG	8	0.30"	0.25"	0.84"	0.69"	0.030"	0.070"	0.145"	100	500
MNG18-8FBK	054007-01216	22 - 18 AWG	8	0.30"	0.25"	0.84"	0.69"	0.030"	0.070"	0.145"	-	1000
MNG18-10FBX	051128-58654	22 - 18 AWG	10	0.30"	0.25"	0.84"	0.69"	0.030"	0.070"	0.145"	100	500
MNG18-10FBK	054007-01217	22 - 18 AWG	10	0.30"	0.25"	0.84"	0.69"	0.030"	0.070"	0.145"	-	1000
MNG14-4FB/SK	054007-02262	16 - 14 AWG	4	0.25"	0.25"	0.86"	0.71"	0.030"	0.090"	0.170"	-	1000
MNG14-6FB/SX	051128-58971	16 - 14 AWG	6	0.25"	0.25"	0.86"	0.71"	0.030"	0.090"	0.170"	100	500
MNG14-6FB/SK	054007-01580	16 - 14 AWG	6	0.25"	0.25"	0.86"	0.71"	0.030"	0.090"	0.170"	-	1000
MNG14-6FBX	051128-58712	16 - 14 AWG	6	0.30"	0.25"	0.86"	0.71"	0.030"	0.090"	0.170"	100	500
MNG14-6FBK	054007-01581	16 - 14 AWG	6	0.30"	0.25"	0.86"	0.71"	0.030"	0.090"	0.170"	-	1000
MNG14-8FBX	051128-58713	16 - 14 AWG	8	0.30"	0.25"	0.86"	0.71"	0.030"	0.090"	0.170"	100	500
MNG14-8FBK	054007-01582	16 - 14 AWG	8	0.30"	0.25"	0.86"	0.71"	0.030"	0.090"	0.170"	-	1000
MNG14-10FBX	051128-58705	16 - 14 AWG	10	0.30"	0.25"	0.86"	0.71"	0.030"	0.090"	0.170"	100	500
MNG14-10FBK	054007-01583	16 - 14 AWG	10	0.30"	0.25"	0.86"	0.71"	0.030"	0.090"	0.170"	-	1000
MNG10-6FBX	051128-58689	12 - 10 AWG	6	0.32"	0.29"	1.03"	0.84"	0.040"	0.135"	0.250"	50	500
MNG10-6FBK	054007-02017	12 - 10 AWG	6	0.32"	0.29"	1.03"	0.84"	0.040"	0.135"	0.250"	-	500
MNG10-8FBX	051128-58690	12 - 10 AWG	8	0.32"	0.29"	1.03"	0.84"	0.040"	0.135"	0.250"	50	500
MNG10-8FBK	054007-02018	12 - 10 AWG	8	0.32"	0.29"	1.03"	0.84"	0.040"	0.135"	0.250"	-	500
MNG10-10FBX	051128-58718	12 - 10 AWG	10	0.32"	0.29"	1.03"	0.84"	0.040"	0.135"	0.250"	50	500
MNG10-10FBK	054007-02019	12 - 10 AWG	10	0.32"	0.29"	1.03"	0.84"	0.040"	0.135"	0.250"	-	500

Vinyl Insulated Brazed Seam Block Forks

Terminal Type Fork
 Terminal Style Block
 Insulation Material Vinyl
 Barrel Style Brazed
 RoHS 2011/65/EU Yes

Agency Approval



Manufacturing Origin

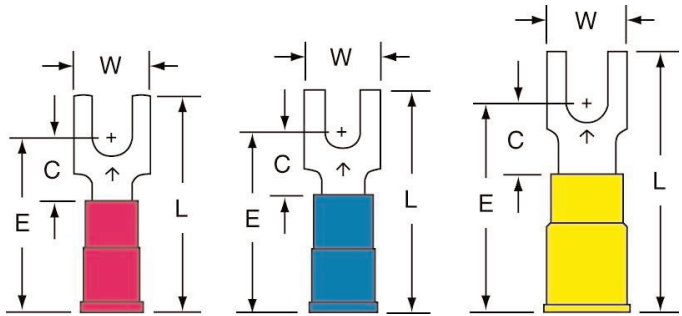

Order No.	UPC	Conductor Size	Stud Size	(W)	(C)	(L)	(E)	Thickness	Barrel I.D.	Max. Insul. Dia.	Terminals per Carton	Terminals per Case
MV18-6FB/SX	051128-58950	22 - 18 AWG	6	0.25"	0.25"	0.85"	0.70"	0.030"	0.070"	0.145"	100	500
MV18-6FB/SK	054007-01210	22 - 18 AWG	6	0.25"	0.25"	0.85"	0.70"	0.030"	0.070"	0.145"	-	1000
MV18-6FBX	051128-58743	22 - 18 AWG	6	0.30"	0.25"	0.85"	0.70"	0.030"	0.070"	0.145"	100	500
MV18-6FBK	054007-01211	22 - 18 AWG	6	0.30"	0.25"	0.85"	0.70"	0.030"	0.070"	0.145"	-	1000
MV18-8FBX	051128-58744	22 - 18 AWG	8	0.30"	0.25"	0.85"	0.70"	0.030"	0.070"	0.145"	100	500
MV18-8FBK	054007-01212	22 - 18 AWG	8	0.30"	0.25"	0.85"	0.70"	0.030"	0.070"	0.145"	-	1000
MV18-10FBX	051128-58745	22 - 18 AWG	10	0.30"	0.25"	0.85"	0.70"	0.030"	0.070"	0.145"	100	500
MV18-10FBK	054007-01213	22 - 18 AWG	10	0.30"	0.25"	0.85"	0.70"	0.030"	0.070"	0.145"	-	1000
MV14-4FB/SK	054007-02280	16 - 14 AWG	4	0.25"	0.25"	0.85"	0.70"	0.030"	0.090"	0.170"	-	1000
MV14-6FB/SX	051128-58970	16 - 14 AWG	6	0.25"	0.25"	0.85"	0.70"	0.030"	0.090"	0.170"	100	500
MV14-6FB/SK	054007-01576	16 - 14 AWG	6	0.25"	0.25"	0.85"	0.70"	0.030"	0.090"	0.170"	-	1000
MV14-6FBX	051128-58746	16 - 14 AWG	6	0.30"	0.25"	0.85"	0.70"	0.030"	0.090"	0.170"	100	500
MV14-6FBK	054007-01577	16 - 14 AWG	6	0.30"	0.25"	0.85"	0.70"	0.030"	0.090"	0.170"	-	1000
MV14-8FBX	051128-58747	16 - 14 AWG	8	0.30"	0.25"	0.85"	0.70"	0.030"	0.090"	0.170"	100	500
MV14-8FBK	054007-01578	16 - 14 AWG	8	0.30"	0.25"	0.85"	0.70"	0.030"	0.090"	0.170"	-	1000
MV14-10FBX	051128-58748	16 - 14 AWG	10	0.30"	0.25"	0.85"	0.70"	0.030"	0.090"	0.170"	100	500
MV14-10FBK	054007-01579	16 - 14 AWG	10	0.30"	0.25"	0.85"	0.70"	0.030"	0.090"	0.170"	-	1000
MV10-6FBX	051128-58764	12 - 10 AWG	6	0.32"	0.29"	1.03"	0.84"	0.040"	0.135"	0.250"	50	500
MV10-6FBK	054007-02014	12 - 10 AWG	6	0.32"	0.29"	1.03"	0.84"	0.040"	0.135"	0.250"	-	500
MV10-8FBX	051128-58765	12 - 10 AWG	8	0.32"	0.29"	1.03"	0.84"	0.040"	0.135"	0.250"	50	500
MV10-8FBK	054007-02015	12 - 10 AWG	8	0.32"	0.29"	1.03"	0.84"	0.040"	0.135"	0.250"	-	500
MV10-10FBX	051128-58766	12 - 10 AWG	10	0.32"	0.29"	1.03"	0.84"	0.040"	0.135"	0.250"	50	500
MV10-10FBK	054007-02016	12 - 10 AWG	10	0.32"	0.29"	1.03"	0.84"	0.040"	0.135"	0.250"	-	500

Vinyl Insulated Butted Seam Block Forks

Terminal Type Fork
 Terminal Style Block
 Insulation Material Vinyl
 Barrel Style Butted
 RoHS 2011/65/EU Yes

Agency Approval





Manufacturing Origin



Order No.	UPC	Conductor Size	Stud Size	(W)	(C)	(L)	(E)	Thickness	Barrel I.D.	Max. Insul. Dia.	Terminals per Carton	Terminals per Case
MVU18-4FB/SK	054007-02253	22 - 18 AWG	4	0.25"	0.25"	0.85"	0.70"	0.030"	0.070"	0.145"	-	1000
MVU18-6FB/SK	054007-01218	22 - 18 AWG	6	0.25"	0.25"	0.85"	0.70"	0.030"	0.070"	0.145"	-	1000
MVU18-6FBX	051128-58885	22 - 18 AWG	6	0.30"	0.25"	0.85"	0.70"	0.030"	0.070"	0.145"	100	500
MVU18-6FBK	054007-01219	22 - 18 AWG	6	0.30"	0.25"	0.85"	0.70"	0.030"	0.070"	0.145"	-	1000
MVU18-8FBX	051128-59032	22 - 18 AWG	8	0.30"	0.25"	0.85"	0.70"	0.030"	0.070"	0.145"	100	500
MVU18-8FBK	054007-01220	22 - 18 AWG	8	0.30"	0.25"	0.85"	0.70"	0.030"	0.070"	0.145"	-	1000
MVU18-10FBX	051128-58816	22 - 18 AWG	10	0.30"	0.25"	0.85"	0.70"	0.030"	0.070"	0.145"	100	500
MVU18-10FBK	054007-01221	22 - 18 AWG	10	0.30"	0.25"	0.85"	0.70"	0.030"	0.070"	0.145"	-	1000
MVU14-4FB/SK	054007-02258	16 - 14 AWG	4	0.25"	0.25"	0.85"	0.70"	0.030"	0.090"	0.170"	-	1000
MVU14-6FB/SX	051128-58886	16 - 14 AWG	6	0.25"	0.25"	0.85"	0.70"	0.030"	0.090"	0.170"	100	500
MVU14-6FB/SK	054007-01584	16 - 14 AWG	6	0.25"	0.25"	0.85"	0.70"	0.030"	0.090"	0.170"	-	1000
MVU14-6FBX	051128-58822	16 - 14 AWG	6	0.30"	0.25"	0.85"	0.70"	0.030"	0.090"	0.170"	100	500
MVU14-6FBK	054007-01585	16 - 14 AWG	6	0.30"	0.25"	0.85"	0.70"	0.030"	0.090"	0.170"	-	1000
MVU14-8FBX	051128-59033	16 - 14 AWG	8	0.30"	0.25"	0.85"	0.70"	0.030"	0.090"	0.170"	100	500
MVU14-8FBK	054007-01586	16 - 14 AWG	8	0.30"	0.25"	0.85"	0.70"	0.030"	0.090"	0.170"	-	1000
MVU14-10FBX	051128-59034	16 - 14 AWG	10	0.30"	0.25"	0.85"	0.70"	0.030"	0.090"	0.170"	100	500
MVU14-10FBK	054007-01587	16 - 14 AWG	10	0.30"	0.25"	0.85"	0.70"	0.030"	0.090"	0.170"	-	1000
MVU10-6FBX	051128-58855	12 - 10 AWG	6	0.32"	0.29"	1.03"	0.84"	0.040"	0.135"	0.250"	50	500
MVU10-6FBK	054007-02020	12 - 10 AWG	6	0.32"	0.29"	1.03"	0.84"	0.040"	0.135"	0.250"	-	500
MVU10-8FBX	051128-59035	12 - 10 AWG	8	0.32"	0.29"	1.03"	0.84"	0.040"	0.135"	0.250"	50	500
MVU10-8FBK	054007-02021	12 - 10 AWG	8	0.32"	0.29"	1.03"	0.84"	0.040"	0.135"	0.250"	-	500
MVU10-10FBX	051128-59036	12 - 10 AWG	10	0.32"	0.29"	1.03"	0.84"	0.040"	0.135"	0.250"	50	500
MVU10-10FBK	054007-02022	12 - 10 AWG	10	0.32"	0.29"	1.03"	0.84"	0.040"	0.135"	0.250"	-	500

Non-Insulated Brazed Seam Block Forks

Terminal Type	Fork
Terminal Style	Block
Insulation Material	Non-Insulated
Barrel Style	Brazed
RoHS 2011/65/EU	Yes
Agency Approval	 
Manufacturing Origin	

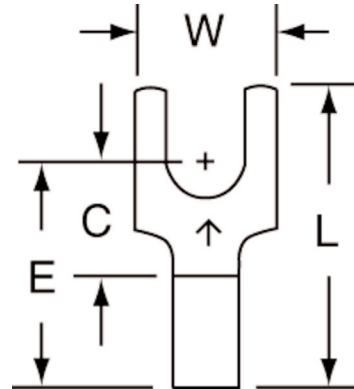

Order No.	UPC	Conductor Size	Stud Size	(W)	(C)	(L)	(E)	Thickness	Barrel I.D.	Terminals per Carton	Terminals per Case
M18-6FB/SX	051128-58948	22 - 18 AWG	6	0.25"	0.25"	0.65"	0.50"	0.030"	0.070"	100	500
M18-6FBX	051128-58645	22 - 18 AWG	6	0.30"	0.25"	0.65"	0.50"	0.030"	0.070"	100	500
M18-8FBK	054007-01204	22 - 18 AWG	8	0.30"	0.25"	0.65"	0.50"	0.030"	0.070"	-	1000
M18-8FBX	051128-58646	22 - 18 AWG	8	0.30"	0.25"	0.65"	0.50"	0.030"	0.070"	100	500
M18-10FBX	051128-58949	22 - 18 AWG	10	0.30"	0.25"	0.65"	0.50"	0.030"	0.070"	100	500
M18-10FBK	054007-01205	22 - 18 AWG	10	0.30"	0.25"	0.65"	0.50"	0.030"	0.070"	-	1000
M14-6FB/SK	054007-01568	16 - 14 AWG	6	0.25"	0.25"	0.65"	0.50"	0.030"	0.090"	-	1000
M14-6FB/SX	051128-58969	16 - 14 AWG	6	0.25"	0.25"	0.65"	0.50"	0.030"	0.090"	100	500
M14-6FBX	054007-01569	16 - 14 AWG	6	0.30"	0.25"	0.65"	0.50"	0.030"	0.090"	-	1000
M14-6FBK	051128-58668	16 - 14 AWG	6	0.30"	0.25"	0.65"	0.50"	0.030"	0.090"	100	500
M14-8FBK	054007-01570	16 - 14 AWG	8	0.30"	0.25"	0.65"	0.50"	0.030"	0.090"	-	1000
M14-8FBX	051128-58711	16 - 14 AWG	8	0.30"	0.25"	0.65"	0.50"	0.030"	0.090"	100	500
M14-10FBX	051128-58669	16 - 14 AWG	10	0.30"	0.25"	0.65"	0.50"	0.030"	0.090"	100	500
M10-6FBK	054007-02008	12 - 10 AWG	6	0.32"	0.29"	0.73"	0.54"	0.040"	0.135"	-	500
M10-6FBX	051128-58862	12 - 10 AWG	6	0.32"	0.29"	0.73"	0.54"	0.040"	0.135"	50	500
M10-8FBK	054007-02009	12 - 10 AWG	8	0.32"	0.29"	0.73"	0.54"	0.040"	0.135"	-	500
M10-8FBX	051128-58719	12 - 10 AWG	8	0.32"	0.29"	0.73"	0.54"	0.040"	0.135"	50	500
M10-10FBK	054007-02010	12 - 10 AWG	10	0.32"	0.29"	0.73"	0.54"	0.040"	0.135"	-	500
M10-10FBX	051128-58720	12 - 10 AWG	10	0.32"	0.29"	0.73"	0.54"	0.040"	0.135"	50	500

Non-Insulated Butted Seam Block Forks

Terminal Type	Fork
Terminal Style	Block
Insulation Material	Non-Insulated
Barrel Style	Butted
RoHS 2011/65/EU	Yes
Agency Approval	
Manufacturing Origin	



Order No.	UPC	Conductor Size	Stud Size	(W)	(C)	(L)	(E)	Thickness	Barrel I.D.	Terminals per Carton	Terminals per Case
MU18-4FB/SK	054007-02263	22 - 18 AWG	4	0.25"	0.25"	0.65"	0.50"	0.030"	0.070"	-	1000
MU18-6FB/SK	054007-01198	22 - 18 AWG	6	0.25"	0.25"	0.65"	0.50"	0.030"	0.070"	-	1000
MU18-6FBK	054007-01199	22 - 18 AWG	6	0.30"	0.25"	0.65"	0.50"	0.030"	0.070"	-	1000
MU18-8FBK	054007-01200	22 - 18 AWG	8	0.30"	0.25"	0.65"	0.50"	0.030"	0.070"	-	1000
MU18-10FBK	054007-01201	22 - 18 AWG	10	0.30"	0.25"	0.65"	0.50"	0.030"	0.070"	-	1000
MU14-4FB/SK	054007-02264	16 - 14 AWG	4	0.25"	0.25"	0.65"	0.50"	0.030"	0.090"	-	1000
MU14-6FB/SK	054007-01564	16 - 14 AWG	6	0.25"	0.25"	0.65"	0.50"	0.030"	0.090"	-	1000
MU14-8FBK	054007-01566	16 - 14 AWG	8	0.30"	0.25"	0.65"	0.50"	0.030"	0.090"	-	1000
MU14-10FBK	054007-01567	16 - 14 AWG	10	0.30"	0.25"	0.65"	0.50"	0.030"	0.090"	-	1000
MU10-6FBK	054007-02005	12 - 10 AWG	6	0.32"	0.29"	0.73"	0.54"	0.040"	0.135"	-	500
MU10-8FBK	054007-02006	12 - 10 AWG	8	0.32"	0.29"	0.73"	0.54"	0.040"	0.135"	-	500
MU10-10FBK	054007-02007	12 - 10 AWG	10	0.32"	0.29"	0.73"	0.54"	0.040"	0.135"	-	500

3M™ Scotchlok™ Flanged Block Forks

Nylon Insulated with Insulation Grip Flanged Block Forks

Terminal Type Fork
 Terminal Style Flanged Block
 Insulation Material Nylon with Insulation Grip
 Barrel Style Butted
 RoHS 2011/65/EU Yes

Agency Approval



Manufacturing Origin



Order No.	UPC	Conductor Size	Stud Size	(W)	(C)	(L)	(E)	Thickness	Barrel I.D.	Max. Insul. Dia.	Terminals per Carton	Terminals per Case
MNG18-6FFB/SX	051128-58952	22 - 18 AWG	6	0.25"	0.25"	0.84"	0.69"	0.030"	0.070"	0.145"	100	500
MNG18-6FFBK	054007-01263	22 - 18 AWG	6	0.30"	0.25"	0.84"	0.69"	0.030"	0.070"	0.145"	-	1000
MNG18-8FFBX	051128-58953	22 - 18 AWG	8	0.30"	0.25"	0.84"	0.69"	0.030"	0.070"	0.145"	100	500
MNG18-8FFBK	054007-01264	22 - 18 AWG	8	0.30"	0.25"	0.84"	0.69"	0.030"	0.070"	0.145"	-	1000
MNG18-10FFBX	051128-58954	22 - 18 AWG	10	0.30"	0.25"	0.84"	0.69"	0.030"	0.070"	0.145"	100	500
MNG18-10FFBK	054007-01265	22 - 18 AWG	10	0.30"	0.25"	0.84"	0.69"	0.030"	0.070"	0.145"	-	1000
MNG14-6FFB/SX	051128-58972	16 - 14 AWG	6	0.25"	0.25"	0.86"	0.71"	0.030"	0.090"	0.170"	100	500
MNG14-6FFBK	054007-01629	16 - 14 AWG	6	0.30"	0.25"	0.86"	0.71"	0.030"	0.090"	0.170"	-	1000
MNG14-8FFBX	051128-58973	16 - 14 AWG	8	0.30"	0.25"	0.86"	0.71"	0.030"	0.090"	0.170"	100	500
MNG14-8FFBK	054007-01630	16 - 14 AWG	8	0.30"	0.25"	0.86"	0.71"	0.030"	0.090"	0.170"	-	1000
MNG14-10FFBX	051128-58974	16 - 14 AWG	10	0.30"	0.25"	0.86"	0.71"	0.030"	0.090"	0.170"	100	500
MNG14-10FFBK	054007-01631	16 - 14 AWG	10	0.30"	0.25"	0.86"	0.71"	0.030"	0.090"	0.170"	-	1000
MNG10-6FFBX	051128-58986	12 - 10 AWG	6	0.32"	0.29"	1.03"	0.84"	0.040"	0.135"	0.250"	50	500
MNG10-8FFBX	051128-58987	12 - 10 AWG	8	0.32"	0.29"	1.03"	0.84"	0.040"	0.135"	0.250"	50	500
MNG10-8FFBK	054007-02036	12 - 10 AWG	8	0.32"	0.29"	1.03"	0.84"	0.040"	0.135"	0.250"	-	500
MNG10-10FFBX	051128-58988	12 - 10 AWG	10	0.32"	0.29"	1.03"	0.84"	0.040"	0.135"	0.250"	50	500
MNG10-10FFBK	054007-02037	12 - 10 AWG	10	0.32"	0.29"	1.03"	0.84"	0.040"	0.135"	0.250"	-	500

Vinyl Insulated Butted Seam Flanged Block Forks

Terminal Type Fork
 Terminal Style Flanged Block
 Insulation Material Vinyl
 Barrel Style Butted
 RoHS 2011/65/EU Yes
 Agency Approval 
 Manufacturing Origin 



Order No.	UPC	Conductor Size	Stud Size	(W)	(C)	(L)	(E)	Thickness	Barrel I.D.	Max. Insul. Dia.	Terminals per Carton	Terminals per Case
MVU18-6FFBK	054007-01267	22 - 18 AWG	6	0.30"	0.25"	0.85"	0.70"	0.030"	0.070"	0.145"	-	1000
MVU18-8FFBK	054007-01268	22 - 18 AWG	8	0.30"	0.25"	0.85"	0.70"	0.030"	0.070"	0.145"	-	1000
MVU18-10FFBK	054007-01269	22 - 18 AWG	10	0.30"	0.25"	0.85"	0.70"	0.030"	0.070"	0.145"	-	1000
MVU14-6FFBK	054007-01633	16 - 14 AWG	6	0.30"	0.25"	0.85"	0.70"	0.030"	0.090"	0.170"	-	1000
MVU14-8FFBK	054007-01634	16 - 14 AWG	8	0.30"	0.25"	0.85"	0.70"	0.030"	0.090"	0.170"	-	1000
MVU14-10FFBK	054007-01635	16 - 14 AWG	10	0.30"	0.25"	0.85"	0.70"	0.030"	0.090"	0.170"	-	1000
MVU10-6FFBK	054007-02038	12 - 10 AWG	6	0.32"	0.29"	1.03"	0.84"	0.040"	0.135"	0.250"	-	500
MVU10-8FFBK	054007-02039	12 - 10 AWG	8	0.32"	0.29"	1.03"	0.84"	0.040"	0.135"	0.250"	-	500
MVU10-10FFBK	054007-02040	12 - 10 AWG	10	0.32"	0.29"	1.03"	0.84"	0.040"	0.135"	0.250"	-	500

Non-Insulated Brazed Seam Flanged Block Forks

Terminal Type Fork
 Terminal Style Flanged Block
 Insulation Material Non-Insulated
 Barrel Style Brazed
 RoHS 2011/65/EU Yes
 Agency Approval 
 Manufacturing Origin 



Order No.	UPC	Conductor Size	Stud Size	(W)	(C)	(L)	(E)	Thickness	Barrel I.D.	Terminals per Carton	Terminals per Case
M14-10FFBK	054007-01619	16 - 14 AWG	10	0.30"	0.25"	0.65"	0.50"	0.030"	0.090"	-	1000
M10-10FFBK	054007-02028	12 - 10 AWG	10	0.32"	0.29"	0.73"	0.54"	0.040"	0.135"	-	500

3M™ Scotchlok™ Flanged Block Forks

Non-Insulated Butted Seam Flanged Block Forks

Terminal Type Fork
 Terminal Style Flanged Block
 Insulation Material Non-Insulated
 Barrel Style Butted
 RoHS 2011/65/EU Yes

Agency Approval



Manufacturing Origin



Order No.	UPC	Conductor Size	Stud Size	(W)	(C)	(L)	(E)	Thickness	Barrel I.D.	Terminals per Carton	Terminals per Case
MU18-6FFBK	054007-01247	22 - 18 AWG	6	0.30"	0.25"	0.65"	0.50"	0.030"	0.070"	-	1000
MU14-8FFBK	054007-01614	16 - 14 AWG	8	0.30"	0.25"	0.65"	0.50"	0.030"	0.090"	-	1000
MU10-8FFBK	054007-02024	12 - 10 AWG	8	0.32"	0.29"	0.73"	0.54"	0.040"	0.135"	-	500

3M™ Scotchlok™ Locking Forks

Heat Shrink Brazed Seam Locking Forks

Terminal Type Fork
 Terminal Style Locking
 Insulation Material Heat Shrink
 Barrel Style Brazed
 RoHS 2011/65/EU Yes

Manufacturing Origin



Order No.	UPC	Conductor Size	Stud Size	(W)	(C)	(L)	(E)	Thickness	Barrel I.D.	Term. per Carton	Term. per Case
MH18-6FLK	054007-06347	22 - 18 AWG	6	0.25"	0.15"	1.00"	0.76"	0.030"	0.070"	-	250
MH18-6FLX	051128-58911	22 - 18 AWG	6	0.25"	0.15"	1.00"	0.76"	0.030"	0.070"	25	125
MH18-8FLK	054007-06362	22 - 18 AWG	8	0.30"	0.15"	1.00"	0.70"	0.030"	0.070"	-	250
MH18-8FLX	051128-59096	22 - 18 AWG	8	0.30"	0.15"	1.00"	0.70"	0.030"	0.070"	25	125
MH18-10FLK	054007-06353	22 - 18 AWG	10	0.32"	0.15"	1.00"	0.76"	0.030"	0.070"	-	250
MH18-10FLX	051128-58915	22 - 18 AWG	10	0.32"	0.15"	1.00"	0.76"	0.030"	0.070"	25	125
MH14-6FLX	051128-58899	16 - 14 AWG	6	0.25"	0.12"	1.00"	0.76"	0.030"	0.090"	25	125
MH14-6FLK	054007-06323	16 - 14 AWG	6	0.25"	0.12"	1.00"	0.76"	0.030"	0.090"	-	250
MH14-8FLX	051128-59094	16 - 14 AWG	8	0.30"	0.12"	1.00"	0.70"	0.030"	0.090"	25	125
MH14-8FLK	054007-06360	16 - 14 AWG	8	0.30"	0.12"	1.00"	0.70"	0.030"	0.090"	-	250
MH14-10FLX	051128-58902	16 - 14 AWG	10	0.32"	0.12"	1.00"	0.76"	0.030"	0.090"	25	125

Heat Shrink Brazed Seam Locking Forks (continued)

Order No.	UPC	Conductor Size	Stud Size	(W)	(C)	(L)	(E)	Thickness	Barrel I.D.	Term. per Carton	Term. per Case
MH14-10FLK	054007-06329	16 - 14 AWG	10	0.32"	0.12"	1.00"	0.76"	0.030"	0.090"	-	250
MH14-14FLX	051128-58904	16 - 14 AWG	1/4"	0.43"	0.27"	1.10"	0.85"	0.030"	0.090"	25	125
MH14-14FLK	054007-06333	16 - 14 AWG	1/4"	0.43"	0.27"	1.10"	0.85"	0.030"	0.090"	-	250
MH10-8FLX	051128-58889	12 - 10 AWG	8	0.32"	0.16"	1.00"	0.80"	0.040"	0.135"	25	125
MH10-8FLK	054007-06358	12 - 10 AWG	8	0.32"	0.16"	1.00"	0.80"	0.040"	0.135"	-	250
MH10-10FLX	051128-58891	12 - 10 AWG	10	0.32"	0.16"	1.00"	0.80"	0.040"	0.135"	25	125
MH10-10FLK	054007-06308	12 - 10 AWG	10	0.32"	0.16"	1.00"	0.80"	0.040"	0.135"	-	250
MH10-14FLX	051128-58893	12 - 10 AWG	1/4"	0.43"	0.30"	1.20"	0.95"	0.040"	0.135"	25	125
MH10-14FLK	054007-06311	12 - 10 AWG	1/4"	0.43"	0.30"	1.20"	0.95"	0.040"	0.135"	-	250

Nylon Insulated with Insulation Grip Locking Forks

- Terminal Type Fork
- Terminal Style Locking
- Insulation Material Nylon with Insulation Grip
- Barrel Style Butted
- RoHS 2011/65/EU Yes
- Agency Approval 

Manufacturing Origin



Order No.	UPC	Conductor Size	Stud Size	Max. Lock Width	(W)	(C)	(L)	(E)	Thickness	Barrel I.D.	Max. Insul. Dia.	Term. per Carton	Term. per Case
MNG18-4FLX	051128-58810	22 - 18 AWG	4	0.27"	0.25"	0.25"	0.87"	0.69"	0.030"	0.070"	0.145"	100	500
MNG18-4FLK	054007-01355	22 - 18 AWG	4	0.27"	0.25"	0.25"	0.87"	0.69"	0.030"	0.070"	0.145"	-	1000
MNG18-6FLX	051128-58804	22 - 18 AWG	6	0.27"	0.25"	0.25"	0.87"	0.69"	0.030"	0.070"	0.145"	100	500
MNG18-6FLK	054007-01356	22 - 18 AWG	6	0.27"	0.25"	0.25"	0.87"	0.69"	0.030"	0.070"	0.145"	-	1000
MNG18-8FLX	051128-58805	22 - 18 AWG	8	0.34"	0.30"	0.25"	0.87"	0.69"	0.030"	0.070"	0.145"	100	500
MNG18-8FLK	054007-01357	22 - 18 AWG	8	0.34"	0.30"	0.25"	0.87"	0.69"	0.030"	0.070"	0.145"	-	1000
MNG18-10FLX	051128-58806	22 - 18 AWG	10	0.35"	0.32"	0.25"	0.87"	0.69"	0.030"	0.070"	0.145"	100	500
MNG18-10FLK	054007-01358	22 - 18 AWG	10	0.35"	0.32"	0.25"	0.87"	0.69"	0.030"	0.070"	0.145"	-	1000
MNG14-4FLX	051128-58801	16 - 14 AWG	4	0.27"	0.25"	0.25"	0.89"	0.71"	0.030"	0.090"	0.170"	100	500
MNG14-6FLX	051128-58802	16 - 14 AWG	6	0.27"	0.24"	0.25"	0.89"	0.71"	0.030"	0.090"	0.170"	100	500
MNG14-6FLK	054007-01867	16 - 14 AWG	6	0.27"	0.24"	0.25"	0.89"	0.71"	0.030"	0.090"	0.170"	-	1000
MNG14-8FLX	051128-58796	16 - 14 AWG	8	0.34"	0.30"	0.25"	0.89"	0.71"	0.030"	0.090"	0.170"	100	500
MNG14-8FLK	054007-01868	16 - 14 AWG	8	0.34"	0.30"	0.25"	0.89"	0.71"	0.030"	0.090"	0.170"	-	1000
MNG14-10FLX	051128-58797	16 - 14 AWG	10	0.35"	0.32"	0.25"	0.89"	0.71"	0.030"	0.090"	0.170"	100	500
MNG14-10FLK	054007-01869	16 - 14 AWG	10	0.35"	0.32"	0.25"	0.89"	0.71"	0.030"	0.090"	0.170"	-	1000
MNG14-14FLX	051128-58798	16 - 14 AWG	1/4"	0.48"	0.43"	0.40"	1.11"	0.86"	0.030"	0.090"	0.170"	100	500
MNG10-6FLK	054007-02106	12 - 10 AWG	6	0.30"	0.28"	0.28"	1.03"	0.83"	0.040"	0.135"	0.250"	-	500
MNG10-6FLX	051128-58794	12 - 10 AWG	6	0.30"	0.28"	0.28"	1.03"	0.83"	0.040"	0.135"	0.250"	50	500

3M™ Scotchlok™ Locking Forks

Nylon Insulated with Insulation Grip Locking Forks (continued)

Order No.	UPC	Conductor Size	Stud Size	Max. Lock Width	(W)	(C)	(L)	(E)	Thickness	Barrel I.D.	Max. Insul. Dia.	Term. per Carton	Term. per Case
MNG10-8FLK	054007-02107	12 - 10 AWG	8	0.35"	0.32"	0.28"	1.03"	0.83"	0.040"	0.135"	0.250"	-	500
MNG10-8FLX	051128-58795	12 - 10 AWG	8	0.35"	0.32"	0.28"	1.03"	0.83"	0.040"	0.135"	0.250"	50	500
MNG10-10FLK	054007-02108	12 - 10 AWG	10	0.36"	0.32"	0.28"	1.03"	0.83"	0.040"	0.135"	0.250"	-	500
MNG10-10FLX	051128-58791	12 - 10 AWG	10	0.36"	0.32"	0.28"	1.03"	0.83"	0.040"	0.135"	0.250"	50	500
MNG10-14FLK	054007-02109	12 - 10 AWG	1/4"	0.48"	0.43"	0.44"	1.24"	0.99"	0.040"	0.135"	0.250"	-	500
MNG10-14FLX	051128-58792	12 - 10 AWG	1/4"	0.48"	0.43"	0.44"	1.24"	0.99"	0.040"	0.135"	0.250"	50	500

Vinyl Insulated Brazed Seam Locking Forks

Terminal Type Fork
 Terminal Style Locking
 Insulation Material Vinyl
 Barrel Style Brazed
 RoHS 2011/65/EU Yes

Agency Approval



Manufacturing Origin

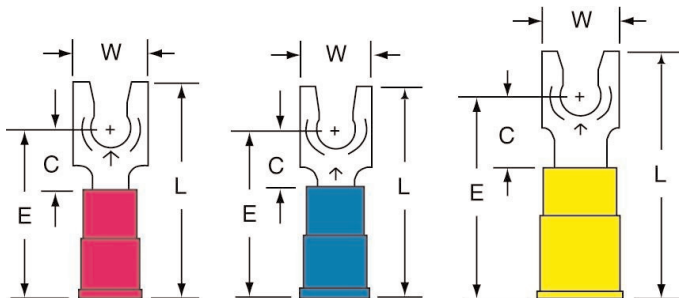

Order No.	UPC	Conductor Size	Stud Size	Max. Lock Width	(W)	(C)	(L)	(E)	Thickness	Barrel I.D.	Max. Insul. Dia.	Term. per Carton	Term. per Case
MV18-4FLX	051128-58849	22 - 18 AWG	4	0.27"	0.25"	0.25"	0.88"	0.70"	0.030"	0.070"	0.145"	100	500
MV18-4FLK	054007-13857	22 - 18 AWG	4	0.27"	0.25"	0.25"	0.88"	0.70"	0.030"	0.070"	0.145"	-	1000
MV18-6FLX	051128-58846	22 - 18 AWG	6	0.27"	0.25"	0.25"	0.88"	0.70"	0.030"	0.070"	0.145"	100	500
MV18-6FLK	054007-13865	22 - 18 AWG	6	0.27"	0.25"	0.25"	0.88"	0.70"	0.030"	0.070"	0.145"	-	1000
MV18-8FLX	051128-58847	22 - 18 AWG	8	0.34"	0.30"	0.25"	0.88"	0.70"	0.030"	0.070"	0.145"	100	500
MV18-8FLK	054007-13873	22 - 18 AWG	8	0.34"	0.30"	0.25"	0.88"	0.70"	0.030"	0.070"	0.145"	-	1000
MV18-10FLX	051128-58844	22 - 18 AWG	10	0.35"	0.32"	0.25"	0.88"	0.70"	0.030"	0.070"	0.145"	100	500
MV18-10FLK	054007-13891	22 - 18 AWG	10	0.35"	0.32"	0.25"	0.88"	0.70"	0.030"	0.070"	0.145"	-	1000
MV14-4FLX	051128-58838	16 - 14 AWG	4	0.27"	0.25"	0.25"	0.88"	0.70"	0.030"	0.090"	0.170"	100	500
MV14-6FLX	051128-58839	16 - 14 AWG	6	0.27"	0.25"	0.25"	0.88"	0.70"	0.030"	0.090"	0.170"	100	500
MV14-6FLK	054007-13907	16 - 14 AWG	6	0.27"	0.25"	0.25"	0.88"	0.70"	0.030"	0.090"	0.170"	-	1000
MV14-8FLX	051128-58836	16 - 14 AWG	8	0.34"	0.30"	0.25"	0.88"	0.70"	0.030"	0.090"	0.170"	100	500
MV14-8FLK	054007-13915	16 - 14 AWG	8	0.34"	0.30"	0.25"	0.88"	0.70"	0.030"	0.090"	0.170"	-	1000
MV14-10FLX	051128-58837	16 - 14 AWG	10	0.35"	0.32"	0.25"	0.88"	0.70"	0.030"	0.090"	0.170"	100	500
MV14-10FLK	054007-13923	16 - 14 AWG	10	0.35"	0.32"	0.25"	0.88"	0.70"	0.030"	0.090"	0.170"	-	1000
MV14-14FLX	051128-58835	16 - 14 AWG	1/4"	0.48"	0.43"	0.40"	1.10"	0.85"	0.030"	0.090"	0.170"	100	500
MV10-6FLX	051128-58832	12 - 10 AWG	6	0.30"	0.28"	0.28"	1.03"	0.83"	0.040"	0.135"	0.250"	50	500
MV10-6FLK	054007-13949	12 - 10 AWG	6	0.30"	0.28"	0.28"	1.03"	0.83"	0.040"	0.135"	0.250"	-	500
MV10-8FLX	051128-58829	12 - 10 AWG	8	0.35"	0.32"	0.28"	1.03"	0.83"	0.040"	0.135"	0.250"	50	500
MV10-8FLK	054007-13956	12 - 10 AWG	8	0.35"	0.32"	0.28"	1.03"	0.83"	0.040"	0.135"	0.250"	-	500
MV10-10FLX	051128-58830	12 - 10 AWG	10	0.36"	0.32"	0.28"	1.03"	0.83"	0.040"	0.135"	0.250"	50	500
MV10-10FLK	054007-13964	12 - 10 AWG	10	0.36"	0.32"	0.28"	1.03"	0.83"	0.040"	0.135"	0.250"	-	500
MV10-14FLX	051128-58828	12 - 10 AWG	1/4"	0.48"	0.43"	0.44"	1.24"	0.99"	0.040"	0.135"	0.250"	50	500
MV10-14FLK	054007-13972	12 - 10 AWG	1/4"	0.48"	0.43"	0.44"	1.24"	0.99"	0.040"	0.135"	0.250"	-	500

Vinyl Insulated Butted Seam Locking Forks

Terminal Type Fork
Terminal Style Locking
Insulation Material Vinyl
Barrel Style Butted
RoHS 2011/65/EU Yes
Agency Approval 
Manufacturing Origin 



Order No.	UPC	Conductor Size	Stud Size	Max. Lock Width	(W)	(C)	(L)	(E)	Thickness	Barrel I.D.	Max. Insul. Dia.	Term. per Carton	Term. per Case
MVU18-4FLK	054007-01359	22 - 18 AWG	4	0.27"	0.25"	0.25"	0.88"	0.70"	0.030"	0.070"	0.145"	-	1000
MVU18-6FLK	054007-01360	22 - 18 AWG	6	0.27"	0.25"	0.25"	0.88"	0.70"	0.030"	0.070"	0.145"	-	1000
MVU18-8FLK	054007-01361	22 - 18 AWG	8	0.34"	0.30"	0.25"	0.88"	0.70"	0.030"	0.070"	0.145"	-	1000
MVU18-10FLK	054007-01362	22 - 18 AWG	10	0.35"	0.32"	0.25"	0.88"	0.70"	0.030"	0.070"	0.145"	-	1000
MVU14-4FLK	054007-01871	16 - 14 AWG	4	0.27"	0.25"	0.25"	0.88"	0.70"	0.030"	0.090"	0.170"	-	1000
MVU14-6FLK	054007-01872	16 - 14 AWG	6	0.27"	0.25"	0.25"	0.88"	0.70"	0.030"	0.090"	0.170"	-	1000
MVU14-8FLK	054007-01873	16 - 14 AWG	8	0.34"	0.30"	0.25"	0.88"	0.70"	0.030"	0.090"	0.170"	-	1000
MVU14-10FLK	054007-01874	16 - 14 AWG	10	0.35"	0.32"	0.25"	0.88"	0.70"	0.030"	0.090"	0.170"	-	1000
MVU14-14FLK	054007-01875	16 - 14 AWG	1/4"	0.48"	0.43"	0.40"	1.10"	0.85"	0.030"	0.090"	0.170"	-	1000
MVU10-6FLK	054007-02114	12 - 10 AWG	6	0.30"	0.28"	0.28"	1.03"	0.83"	0.040"	0.135"	0.250"	-	500
MVU10-8FLK	054007-02115	12 - 10 AWG	8	0.35"	0.32"	0.28"	1.03"	0.83"	0.040"	0.135"	0.250"	-	500
MVU10-10FLK	054007-02116	12 - 10 AWG	10	0.36"	0.32"	0.28"	1.03"	0.83"	0.040"	0.135"	0.250"	-	500
MVU10-14FLK	054007-02117	12 - 10 AWG	1/4"	0.48"	0.43"	0.44"	1.24"	0.99"	0.040"	0.135"	0.250"	-	500

Non-Insulated Brazed Seam Locking Forks

Terminal Type Fork
 Terminal Style Locking
 Insulation Material Non-Insulated
 Barrel Style Brazed
 RoHS 2011/65/EU Yes

Agency Approval



Manufacturing Origin



Order No.	UPC	Conductor Size	Stud Size	Max. Lock Width	(W)	(C)	(L)	(E)	Thickness	Barrel I.D.	Term. per Carton	Term. per Case
M18-6FLK	054007-13733	22 - 18 AWG	6	0.27"	0.25"	0.25"	0.68"	0.50"	0.030"	0.070"	-	1000
M18-6FLX	051128-58850	22 - 18 AWG	6	0.27"	0.25"	0.25"	0.68"	0.50"	0.030"	0.070"	100	500
M18-8FLX	051128-58851	22 - 18 AWG	8	0.34"	0.30"	0.25"	0.68"	0.50"	0.030"	0.070"	100	500
M18-10FLX	051128-58848	22 - 18 AWG	10	0.35"	0.32"	0.25"	0.68"	0.50"	0.030"	0.070"	100	500
M14-6FLK	054007-13775	16 - 14 AWG	6	0.27"	0.25"	0.25"	0.68"	0.50"	0.030"	0.090"	-	1000
M14-6FLX	051128-58842	16 - 14 AWG	6	0.27"	0.25"	0.25"	0.68"	0.50"	0.030"	0.090"	100	500
M14-8FLX	051128-58843	16 - 14 AWG	8	0.34"	0.30"	0.25"	0.68"	0.50"	0.030"	0.090"	100	500
M14-10FLK	054007-13800	16 - 14 AWG	10	0.35"	0.32"	0.25"	0.68"	0.50"	0.030"	0.090"	-	1000
M14-10FLX	051128-58840	16 - 14 AWG	10	0.35"	0.32"	0.25"	0.68"	0.50"	0.030"	0.090"	100	500
M14-14FLX	051128-58841	16 - 14 AWG	1/4"	0.48"	0.43"	0.40"	0.90"	0.65"	0.030"	0.090"	100	500
M10-8FLX	051128-58833	12 - 10 AWG	8	0.35"	0.32"	0.28"	0.73"	0.53"	0.040"	0.135"	50	500
M10-10FLX	051128-58834	12 - 10 AWG	10	0.36"	0.32"	0.28"	0.73"	0.53"	0.040"	0.135"	50	500
M10-10FLK	054007-13832	12 - 10 AWG	10	0.36"	0.32"	0.28"	0.73"	0.53"	0.040"	0.135"	-	500
M10-14FLX	051128-58831	12 - 10 AWG	1/4"	0.48"	0.43"	0.44"	0.94"	0.69"	0.040"	0.135"	50	500
M10-14FLK	054007-13850	12 - 10 AWG	1/4"	0.48"	0.43"	0.44"	0.94"	0.69"	0.040"	0.135"	-	500

Non-Insulated Butted Seam Locking Forks

Terminal Type	Fork
Terminal Style	Locking
Insulation Material	Non-Insulated
Barrel Style	Butted
RoHS 2011/65/EU	Yes
Agency Approval	 
Manufacturing Origin	



Order No.	UPC	Conductor Size	Stud Size	Max. Lock Width	(W)	(C)	(L)	(E)	Thickness	Barrel I.D.	Term. per Carton	Term. per Case
MU18-4FLK	054007-01347	22 - 18 AWG	4	0.27"	0.25"	0.25"	0.68"	0.50"	0.030"	0.070"	-	1000
MU18-6FLK	054007-01348	22 - 18 AWG	6	0.27"	0.25"	0.25"	0.68"	0.50"	0.030"	0.070"	-	1000
MU18-6FLX	051128-59015	22 - 18 AWG	6	0.27"	0.25"	0.25"	0.68"	0.50"	0.030"	0.070"	100	500
MU18-8FLK	054007-01349	22 - 18 AWG	8	0.34"	0.30"	0.25"	0.68"	0.50"	0.030"	0.070"	-	1000
MU18-8FLX	051128-59016	22 - 18 AWG	8	0.34"	0.30"	0.25"	0.68"	0.50"	0.030"	0.070"	100	500
MU18-10FLK	054007-01350	22 - 18 AWG	10	0.35"	0.32"	0.25"	0.68"	0.50"	0.030"	0.070"	-	1000
MU18-10FLX	051128-59017	22 - 18 AWG	10	0.35"	0.32"	0.25"	0.68"	0.50"	0.030"	0.070"	100	500
MU14-6FLK	054007-01857	16 - 14 AWG	6	0.27"	0.25"	0.25"	0.68"	0.50"	0.030"	0.090"	-	1000
MU14-6FLX	051128-59018	16 - 14 AWG	6	0.27"	0.25"	0.25"	0.68"	0.50"	0.030"	0.090"	100	500
MU14-8FLK	054007-01858	16 - 14 AWG	8	0.34"	0.30"	0.25"	0.68"	0.50"	0.030"	0.090"	-	1000
MU14-8FLX	051128-59019	16 - 14 AWG	8	0.34"	0.30"	0.25"	0.68"	0.50"	0.030"	0.090"	100	500
MU14-10FLK	054007-01859	16 - 14 AWG	10	0.35"	0.32"	0.25"	0.68"	0.50"	0.030"	0.090"	-	1000
MU14-10FLX	051128-59020	16 - 14 AWG	10	0.35"	0.32"	0.25"	0.68"	0.50"	0.030"	0.090"	100	500
MU14-14FLK	054007-01860	16 - 14 AWG	1/4"	0.48"	0.43"	0.40"	0.90"	0.65"	0.030"	0.090"	-	1000
MU10-8FLK	054007-02103	12 - 10 AWG	8	0.35"	0.32"	0.28"	0.73"	0.53"	0.040"	0.135"	-	500
MU10-8FLX	051128-59021	12 - 10 AWG	8	0.35"	0.32"	0.28"	0.73"	0.53"	0.040"	0.135"	100	500
MU10-10FLK	054007-02104	12 - 10 AWG	10	0.36"	0.32"	0.28"	0.73"	0.53"	0.040"	0.135"	-	500
MU10-10FLX	051128-59022	12 - 10 AWG	10	0.36"	0.32"	0.28"	0.73"	0.53"	0.040"	0.135"	50	500
MU10-14FLK	054007-02105	12 - 10 AWG	1/4"	0.48"	0.43"	0.44"	0.94"	0.69"	0.040"	0.135"	-	500
MU10-14FLX	051128-59023	12 - 10 AWG	1/4"	0.48"	0.43"	0.44"	0.94"	0.69"	0.040"	0.135"	50	500

3M™ Scotchlok™ Butt Connectors

Heat Shrink Seamless Butt Connectors

Terminal Type: Butt
 Terminal Style: Standard
 Insulation Material: Heat Shrink
 Barrel Style: Seamless
 RoHS 2011/65/EU: Yes

Manufacturing Origin



Order No.	UPC	Conductor Size	(L)	Thickness	Barrel Length	Barrel I.D.	Terminals per Carton	Terminals per Case
MH18BCK	054007-06343	22 - 18 AWG	1.20"	0.031"	0.28"	0.062"	-	250
MH18BCX	051128-58909	22 - 18 AWG	1.20"	0.031"	0.28"	0.062"	25	125
MH14BCK	054007-06319	16 - 14 AWG	1.30"	0.031"	0.30"	0.095"	-	250
MH14BCX	051128-58897	16 - 14 AWG	1.30"	0.031"	0.30"	0.095"	25	125
MH10BCK	054007-06301	12 - 10 AWG	1.50"	0.031"	0.38"	0.142"	-	250
MH10BCX	051128-59093	12 - 10 AWG	1.50"	0.031"	0.38"	0.142"	25	125

Nylon Insulated Seamless Butt Connectors

Terminal Type: Butt
 Terminal Style: Standard
 Insulation Material: Nylon
 Barrel Style: Seamless
 RoHS 2011/65/EU: Yes

Agency Approval



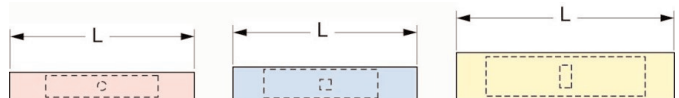

Except for MN24 Butt Connectors



Order No.	UPC	Conductor Size	(L)	Thickness	Barrel Length	Barrel I.D.	Max. Insul. Dia.	Terminals per Carton	Terminals per Case
MN18BCK-A	054007-15983	22 - 18 AWG	1.02"	0.031"	0.28"	0.062"	0.125"	-	10000
MN18BCX	051128-58647	22 - 18 AWG	1.02"	0.031"	0.28"	0.062"	0.125"	100	500
MN18BCX-A	051128-58999	22 - 18 AWG	1.02"	0.031"	0.28"	0.062"	0.125"	100	500
MN14BCK-A	054007-01819	16 - 14 AWG	1.02"	0.031"	0.30"	0.095"	0.155"	-	8000
MN14BCX	051128-58680	16 - 14 AWG	1.02"	0.031"	0.30"	0.095"	0.155"	100	500
MN14BCX-A	051128-59000	16 - 14 AWG	1.02"	0.031"	0.30"	0.095"	0.155"	100	500
MN10BCK-A	054007-02080	12 - 10 AWG	1.20"	0.038"	0.38"	0.142"	0.218"	-	4000
MN10BCX	051128-58723	12 - 10 AWG	1.20"	0.038"	0.38"	0.142"	0.218"	50	500
MN10BCX-A	051128-59001	12 - 10 AWG	1.20"	0.038"	0.38"	0.142"	0.218"	50	500

Nylon Insulated with Insulation Grip Butt Connectors

Terminal Type: Butt
 Terminal Style: Standard
 Insulation Material: Nylon with Insulation Grip
 Barrel Style: Butted
 RoHS 2011/65/EU: Yes
 Agency Approval: 
 Manufacturing Origin:  With U.S. and Global Content



Order No.	UPC	Conductor Size	(L)	Thickness	Barrel Length	Barrel I.D.	Max. Insul. Dia.	Terminals per Carton	Terminals per Case
MNG18BCK	054007-01313	22 - 18 AWG	1.00"	0.030"	0.25"	0.070"	0.145"	-	1000
MNG18BCX	051128-58648	22 - 18 AWG	1.00"	0.030"	0.25"	0.070"	0.145"	100	500
MNG14BCK	054007-01818	16 - 14 AWG	1.00"	0.030"	0.25"	0.090"	0.170"	-	1000
MNG14BCX	051128-58679	16 - 14 AWG	1.00"	0.030"	0.25"	0.090"	0.170"	100	500
MNG10BCK	054007-15967	12 - 10 AWG	1.15"	0.040"	0.25"	0.135"	0.250"	-	500
MNG10BCX	051128-58692	12 - 10 AWG	1.15"	0.040"	0.25"	0.135"	0.250"	50	500

Nylon Insulated with Insulation Grip Grease Filled Butt Connectors

Terminal Type: Butt
 Terminal Style: Moisture Resistant
 Insulation Material: Nylon with Insulation Grip
 Barrel Style: Butted
 RoHS 2011/65/EU: Yes
 Manufacturing Origin:  With U.S. and Global Content



Order No.	UPC	Conductor Size	(L)	Thickness	Barrel Length	Barrel I.D.	Max. Insul. Dia.	Terminals per Carton	Terminals per Case
MNG18BCMK-A	051138-98029	22 - 18 AWG	1.02"	0.030"	0.25"	0.070"	0.145"	-	1000
MNG18BCMX-A	051128-58993	22 - 18 AWG	1.02"	0.030"	0.25"	0.070"	0.145"	100	500
MNG14BCMK-A	051138-98035	16 - 14 AWG	1.06"	0.030"	0.25"	0.090"	0.170"	-	1000
MNG14BCMX-A	051128-58994	16 - 14 AWG	1.06"	0.030"	0.25"	0.090"	0.170"	100	500
MNG10BCMK-A	051138-98039	12 - 10 AWG	1.23"	0.040"	0.25"	0.135"	0.250"	-	500
MNG10BCMX-A	051128-58995	12 - 10 AWG	1.23"	0.040"	0.25"	0.135"	0.250"	50	500

3M™ Scotchlok™ Butt Connectors

Vinyl Insulated Seamless Butt Connectors

Terminal Type Butt
 Terminal Style Standard
 Insulation Material Vinyl
 Barrel Style Seamless
 RoHS 2011/65/EU Yes

Agency Approval  

Manufacturing Origin 



Order No.	UPC	Conductor Size	(L)	Thickness	Barrel Length	Barrel I.D.	Max. Insul. Dia.	Terminals per Carton	Terminals per Case
MV18BCK	054007-01312	22 - 18 AWG	1.02"	0.031"	0.28"	0.062"	0.125"	-	1000
MV18BCX	051128-58739	22 - 18 AWG	1.02"	0.031"	0.28"	0.062"	0.125"	100	500
MV14BCK	054007-01817	16 - 14 AWG	1.02"	0.031"	0.30"	0.095"	0.155"	-	1000
MV14BCX	051128-58740	16 - 14 AWG	1.02"	0.031"	0.30"	0.095"	0.155"	100	500
MV10BCK	054007-02078	12 - 10 AWG	1.20"	0.038"	0.38"	0.142"	0.218"	-	500
MV10BCX	051128-58767	12 - 10 AWG	1.20"	0.038"	0.38"	0.142"	0.218"	50	500

Vinyl Insulated Brazed Seam Butt Connectors

Terminal Type Butt
 Terminal Style Standard
 Insulation Material Vinyl
 Barrel Style Brazed
 RoHS 2011/65/EU Yes

Agency Approval  

Manufacturing Origin 



Order No.	UPC	Conductor Size	(L)	Thickness	Barrel Length	Barrel I.D.	Max. Insul. Dia.	Terminals per Carton	Terminals per Case
MV8BCK	054007-02144	8 AWG	1.50"	0.050"	0.38"	0.175"	0.300"	-	200
MV8BCX	051128-58773	8 AWG	1.50"	0.050"	0.38"	0.175"	0.300"	10	100
MV6BCK	054007-02173	6 AWG	1.71"	0.050"	0.47"	0.250"	0.400"	-	200
MV6BCX	051128-58991	6 AWG	1.71"	0.050"	0.47"	0.250"	0.400"	10	100
MV4BCK	054007-02198	4 AWG	2.17"	0.075"	0.53"	0.280"	0.480"	-	200
MV4BCX	051128-59003	4 AWG	2.17"	0.075"	0.53"	0.280"	0.480"	10	100

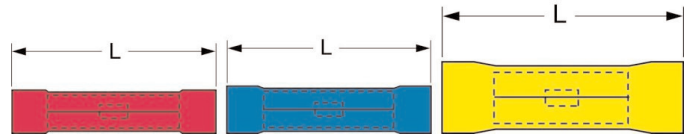

Vinyl Insulated Butted Seam Butt Connectors

Terminal Type: Butt
 Terminal Style: Standard
 Insulation Material: Vinyl
 Barrel Style: Butted
 RoHS 2011/65/EU: Yes
 Agency Approval: 
 Manufacturing Origin: 



Order No.	UPC	Conductor Size	(L)	Thickness	Barrel Length	Barrel I.D.	Max. Insul. Dia.	Terminals per Carton	Terminals per Case
MVU18BCK	054007-01315	22 - 18 AWG	1.00"	0.030"	0.25"	0.070"	0.145"	-	1000
MVU18BCX	051128-58817	22 - 18 AWG	1.00"	0.030"	0.25"	0.070"	0.145"	100	500
MVU14BCK	054007-01820	16 - 14 AWG	1.00"	0.030"	0.25"	0.090"	0.170"	-	1000
MVU14BCX	051128-58823	16 - 14 AWG	1.00"	0.030"	0.25"	0.090"	0.170"	100	500
MVU10BCK	054007-02081	12 - 10 AWG	1.02"	0.040"	0.25"	0.135"	0.250"	-	500
MVU10BCX	051128-58827	12 - 10 AWG	1.02"	0.040"	0.25"	0.135"	0.250"	50	500

Non-Insulated Seamless Butt Connectors

Terminal Type: Butt
 Terminal Style: Standard
 Insulation Material: Non-Insulated
 Barrel Style: Seamless
 RoHS 2011/65/EU: Yes
 Agency Approval: 
 Manufacturing Origin: 

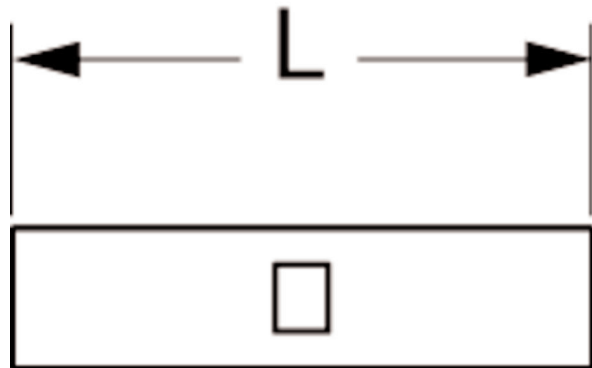

Order No.	UPC	Conductor Size	(L)	Thickness	Barrel Length	Barrel I.D.	Terminals per Carton	Terminals per Case
M18BCK	054007-01311	22 - 18 AWG	0.63"	0.031"	0.28"	0.062"	-	1000
M18BCX	051128-58649	22 - 18 AWG	0.63"	0.031"	0.28"	0.062"	100	500
M14BCK	054007-01816	16 - 14 AWG	0.66"	0.031"	0.30"	0.095"	-	1000
M14BCX	051128-58725	16 - 14 AWG	0.66"	0.031"	0.30"	0.095"	100	500
M10BCK	054007-02077	12 - 10 AWG	0.81"	0.038"	0.38"	0.142"	-	500
M10BCX	051128-58726	12 - 10 AWG	0.81"	0.038"	0.38"	0.142"	50	500

Non-Insulated Seamless Compression Butt Connectors

Terminal Type Butt
Terminal Style Compression Connector
Insulation Material Non-Insulated
Barrel Style Seamless
RoHS 2011/65/EU Yes
Agency Approval 
Manufacturing Origin 



Order No.	UPC	Conductor Size	(L)	Barrel I.D.	Terminals per Carton	Terminals per Case
MC2BCX	054007-09205	2 AWG	1.35"	0.341"	10	100
MC1BCX	054007-09206	1 AWG	1.35"	0.365"	10	100
MC1/OBCX	054007-09207	1/0 AWG	1.55"	0.412"	10	100
MC2/OBCX	054007-09208	2/0 AWG	1.80"	0.466"	10	100
MC3/OBCX	054007-09209	3/0 AWG	1.90"	0.516"	3	30
MC4/OBCX	054007-09210	4/0 AWG	2.00"	0.564"	3	30
MC250BCX	054007-09211	250 kcmil	2.00"	0.595"	3	30

Non-Insulated Brazed Seam Butt Connectors



Terminal Type Butt
Terminal Style Standard
Insulation Material Non-Insulated
Barrel Style Brazed
RoHS 2011/65/EU Yes
Agency Approval 
Manufacturing Origin 



Order No.	UPC	Conductor Size	(L)	Thickness	Barrel Length	Barrel I.D.	Terminals per Carton	Terminals per Case
M8BCK	054007-02143	8 AWG	0.81"	0.050"	0.38"	0.175"	-	200
M8BCX	051128-58727	8 AWG	0.81"	0.050"	0.38"	0.175"	10	100
M6BCK	054007-02172	6 AWG	1.02"	0.050"	0.47"	0.250"	-	200
M6BCX	054007-24225	6 AWG	1.02"	0.050"	0.47"	0.250"	20	200
M4BCK	054007-02197	4 AWG	1.13"	0.075"	0.53"	0.280"	-	200
M4BCX	051128-58728	4 AWG	1.13"	0.075"	0.53"	0.280"	10	100

3M™ Scotchlok™ Butt Connectors

Non-Insulated Butted Seam Butt Connectors

Terminal Type	Butt
Terminal Style	Standard
Insulation Material	Non-Insulated
Barrel Style	Butted
RoHS 2011/65/EU	Yes
Agency Approval	
Manufacturing Origin	



Order No.	UPC	Conductor Size	(L)	Thickness	Barrel Length	Barrel I.D.	Terminals per Carton	Terminals per Case
MU18BCX	051128-59006	22 - 18 AWG	0.56"	0.030"	0.25"	0.070"	100	500
MU14BCX	051128-59007	16 - 14 AWG	0.56"	0.030"	0.25"	0.090"	100	500
MU10BCX	051128-59008	12 - 10 AWG	0.56"	0.040"	0.25"	0.135"	50	500

3M™ Scotchlok™ Female Disconnects

Heat Shrink Nylon Fully Insulated Female Disconnects

Terminal Type	Disconnect
Terminal Style	Fully Insulated
Fastener Orientation	Female
Insulation Material	Heat Shrink
Barrel Style	Butted
RoHS 2011/65/EU	Yes
Manufacturing Origin	

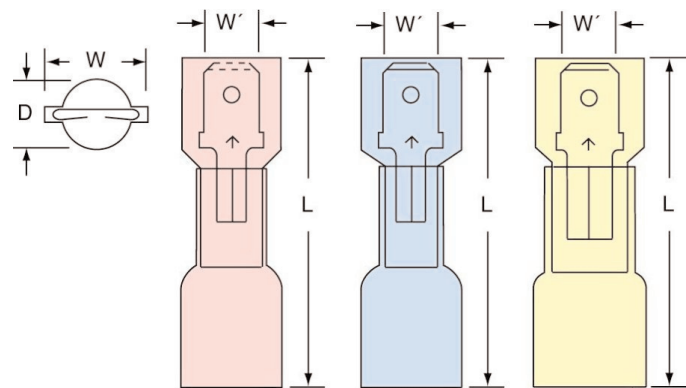

Order No.	UPC	Conductor Size	Male Tab Width (W')	(W)	(L)	Diameter (D)	Thickness	Barrel I.D.	Terminals per Carton	Terminals per Case
MNHU18-250DFIX	051128-58916	22 - 18 AWG	0.250"	0.37"	1.20"	0.23"	0.032"	0.080"	25	125
MNHU18-250DFIK	054007-06355	22 - 18 AWG	0.250"	0.37"	1.20"	0.23"	0.032"	0.080"	-	250
MNHU14-250DFIX	051128-58907	16 - 14 AWG	0.250"	0.37"	1.20"	0.23"	0.032"	0.080"	25	125
MNHU14-250DFIK	054007-06339	16 - 14 AWG	0.250"	0.37"	1.20"	0.23"	0.032"	0.080"	-	250
MNHU10-250DFIX	051128-58895	12 - 10 AWG	0.250"	0.39"	1.20"	0.32"	0.032"	0.165"	25	125
MNHU10-250DFIK	054007-06315	12 - 10 AWG	0.250"	0.39"	1.20"	0.32"	0.032"	0.165"	-	250

Nylon Fully Insulated with Insulation Grip Interlock Barrel Female Disconnects

Terminal Type Disconnect
 Terminal Style Fully Insulated
 Fastener Orientation Female
 Insulation Material Nylon with Insulation Grip
 Barrel Style Interlock Barrel
 Barrel Length 0.250"
 RoHS 2011/65/EU Yes

Agency Approval



Manufacturing Origin



Order No.	UPC	Conductor Size	Male Tab Width (W')	(L)	Thickness	Barrel I.D.	Max. Insul. Dia.	Terminals per Carton	Terminals per Case
MNGI18-250DFIK	054007-69567	22 - 18 AWG	0.250"	0.83"	0.032"	0.080"	0.145"	-	1000
MNGI18-250DFIX	051128-58924	22 - 18 AWG	0.250"	0.83"	0.032"	0.080"	0.145"	100	500
MNGI14-250DFIK	054007-69565	16 - 14 AWG	0.250"	0.83"	0.032"	0.080"	0.145"	-	1000
MNGI14-250DFIX	051128-58922	16 - 14 AWG	0.250"	0.83"	0.032"	0.080"	0.145"	100	500
MNGI10-250DFIK	054007-69563	12 - 10 AWG	0.250"	0.94"	0.032"	0.165"	0.250"	-	500
MNGI10-250DFIX	051128-58920	12 - 10 AWG	0.250"	0.94"	0.032"	0.165"	0.250"	50	500

Nylon Fully Insulated Interlock Barrel Female Disconnects

Terminal Type	Disconnect
Terminal Style	Fully Insulated
Fastener Orientation	Female
Insulation Material	Nylon
Barrel Style	Interlocking Barrel
Barrel Length	0.250"
Max. Insul. Dia.	0.145"
RoHS 2011/65/EU	Yes
Agency Approval	
Manufacturing Origin	



Order No.	UPC	Conductor Size	Male Tab Width (W')	(L)	Thickness	Barrel I.D.	Term. per Carton	Term. per Case
MNI18-250DFIX	051128-58933	22 - 18 AWG	0.250"	0.91"	0.032"	0.076"	100	500
MNI18-250DFIK	054007-69577	22 - 18 AWG	0.250"	0.91"	0.032"	0.076"	-	1000
MNI14-250DFIX	051128-58932	16 - 14 AWG	0.250"	0.91"	0.032"	0.076"	100	500
MNI14-250DFIK	054007-69575	16 - 14 AWG	0.250"	0.91"	0.032"	0.076"	-	1000
MNI10-250DFIX	051128-58930	12 - 10 AWG	0.250"	0.99"	0.032"	0.128"	50	500
MNI10-250DFIK	054007-69573	12 - 10 AWG	0.250"	0.99"	0.032"	0.128"	-	500

Nylon Fully Insulated with Insulation Grip Female Disconnects

Terminal Type Disconnect
 Terminal Style Fully Insulated
 Fastener Orientation Female
 Insulation Material Nylon with Insulation Grip
 Barrel Style Butted
 RoHS 2011/65/EU Yes

Agency Approval



Manufacturing Origin



Order No.	UPC	Conductor Size	Mates with Male Tab Width (W')	(L)	(W)	Diameter (D)	Thickness	Barrel I.D.	Max. Insul. Dia.	Term. per Carton	Term. per Case
MNG18-187DFIX	051128-58808	22 - 18 AWG	0.187"	0.81"	0.30"	0.23"	0.020"	0.085"	0.145"	100	500
MNG18-187DFIK	054007-11816	22 - 18 AWG	0.187"	0.81"	0.30"	0.23"	0.020"	0.085"	0.145"	-	1000
MNG18-250DFIX	051128-58809	22 - 18 AWG	0.250"	0.87"	0.37"	0.23"	0.032"	0.080"	0.145"	100	500
MNG18-250DFIK	054007-02293	22 - 18 AWG	0.250"	0.87"	0.37"	0.23"	0.032"	0.080"	0.145"	-	1000
MNG14-187DFIX	051128-58724	16 - 14 AWG	0.187"	0.81"	0.30"	0.23"	0.020"	0.085"	0.145"	100	500
MNG14-187DFIK	054007-15975	16 - 14 AWG	0.187"	0.81"	0.30"	0.23"	0.020"	0.085"	0.145"	-	1000
MNG14-250DFIX	051128-58800	16 - 14 AWG	0.250"	0.87"	0.37"	0.23"	0.032"	0.080"	0.145"	100	500
MNG14-250DFIK	054007-01841	16 - 14 AWG	0.250"	0.87"	0.37"	0.23"	0.032"	0.080"	0.145"	-	1000

Nylon Fully Insulated Butted Seam Female Disconnects

Terminal Type	Disconnect
Terminal Style	Fully Insulated
Fastener Orientation	Female
Insulation Material	Nylon
Barrel Style	Butted
RoHS 2011/65/EU	Yes
Agency Approval	
Manufacturing Origin	



Order No.	UPC	Conductor Size	Mates with Male Tab Width (W')	(W)	(L)	Diameter (D)	Thickness	Barrel I.D.	Max. Insul. Dia.	Terminals per Carton	Terminals per Case
MNU18-250DFIK	054007-02290	22 - 18 AWG	0.250"	0.37"	0.87"	0.23"	0.032"	0.080"	0.145"	-	1000
MNU18-250DFIX	051128-58776	22 - 18 AWG	0.250"	0.37"	0.87"	0.23"	0.032"	0.080"	0.145"	100	500
MNU18-187DFIK	054007-02370	22 - 18 AWG	0.187"	0.30"	0.81"	0.23"	0.020"	0.085"	0.145"	-	1000
MNU18-187DFIX	051128-58783	22 - 18 AWG	0.187"	0.30"	0.81"	0.23"	0.020"	0.085"	0.145"	100	500
MNU14-250DFIK	054007-02291	16 - 14 AWG	0.250"	0.37"	0.87"	0.23"	0.032"	0.080"	0.145"	-	1000
MNU14-250DFIX	051128-58777	16 - 14 AWG	0.250"	0.37"	0.87"	0.23"	0.032"	0.080"	0.145"	100	500
MNU14-187DFIK	054007-02384	16 - 14 AWG	0.187"	0.30"	0.81"	0.23"	0.020"	0.085"	0.145"	-	1000
MNU14-187DFIX	051128-58787	16 - 14 AWG	0.187"	0.30"	0.81"	0.23"	0.020"	0.085"	0.145"	100	500
MNU10-250DFIX	051128-58812	12 - 10 AWG	0.250"	-	-	0.99"	0.032"	0.128"	-	50	500

Nylon Insulated with Insulation Grip Interlock Barrel Female Disconnects

Terminal Type Disconnect
 Terminal Style Standard
 Fastener Orientation Female
 Insulation Material Nylon with Insulation Grip
 Barrel Style Interlocking Barrel
 RoHS 2011/65/EU Yes
 Agency Approval 

Manufacturing Origin 
 With U.S. and Global Content



Order No.	UPC	Conductor Size	Mates with Male Tab Width (W')	(L)	Thickness	Barrel I.D.	Max. Insul. Dia.	Terminals per Carton	Terminals per Case
MNGI18-250DFX	051128-58929	22 - 18 AWG	0.250"	0.83"	0.032"	0.076"	0.145"	100	500
MNGI18-250DFK	054007-69572	22 - 18 AWG	0.250"	0.83"	0.032"	0.076"	0.145"	-	1000
MNGI14-250DFX	051128-58927	16 - 14 AWG	0.250"	0.83"	0.032"	0.076"	0.145"	100	500
MNGI14-250DFK	054007-69570	16 - 14 AWG	0.250"	0.83"	0.032"	0.076"	0.145"	-	1000
MNGI10-250DFX	051128-58925	12 - 10 AWG	0.250"	0.94"	0.032"	0.128"	0.250"	50	500
MNGI10-250DFK	054007-69568	12 - 10 AWG	0.250"	0.94"	0.032"	0.128"	0.250"	-	500

Nylon Insulated with Insulation Grip Bullet Style Female Disconnects

Terminal Type Disconnect
 Terminal Style Bullet Snap Plug
 Fastener Orientation Female
 Insulation Material Nylon with Insulation Grip
 Barrel Style Butted
 RoHS 2011/65/EU Yes
 Manufacturing Origin Taiwan



Order No.	UPC	Conductor Size	Mating Snap Diameter (S)	(L)	Barrel I.D.	Max. Insul. Dia.	Terminals per Carton	Terminals per Case
MNG18-156DFIK-A	051138-98078	22 - 18 AWG	0.156"	0.99"	0.145"	0.150"	-	1000
MNG18-180DFIK-A	051138-98084	22 - 18 AWG	0.180"	1.00"	0.095"	0.150"	-	1000
MNG14-156DFIK-A	051138-98117	16 - 14 AWG	0.156"	0.99"	0.115"	0.190"	-	1000
MNG14-156DFIX-A	051128-58870	16 - 14 AWG	0.156"	0.99"	0.115"	0.190"	100	500
MNG14-180DFIK-A	051138-98127	16 - 14 AWG	0.180"	1.00"	0.115"	0.190"	-	1000
MNG14-180DFIX-A	051128-58869	16 - 14 AWG	0.180"	1.00"	0.115"	0.190"	100	500

Nylon Insulated with Insulation Grip Female Disconnects

Terminal Type	Disconnect
Terminal Style	Standard
Fastener Orientation	Female
Insulation Material	Nylon with Insulation Grip
Barrel Style	Butted
RoHS 2011/65/EU	Yes
Agency Approval	 Except for 110DF & 375DF Female Disconnects
Manufacturing Origin	 Product numbers ending with "-A" are made in Taiwan.

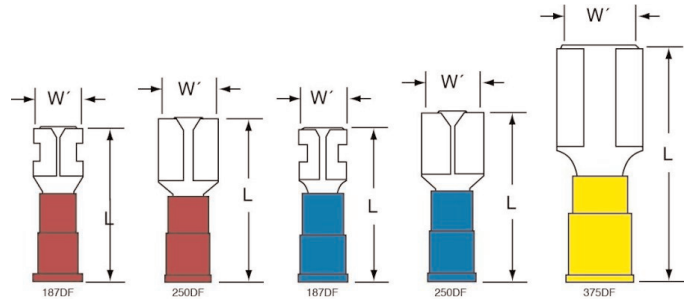

Order No.	UPC	Conductor Size	Mates with Male Tab Width (W')	Thickness	(L)	Barrel I.D.	Max. Insul. Dia.	Terminals per Carton	Terminals per Case
MNG18-110DFK-A	051128-57445	22 - 18 AWG	0.110"	0.020"	0.77"	0.080"	0.160"	-	1000
MNG18-187DFK	054007-02405	22 - 18 AWG	0.187"	0.020"	0.77"	0.085"	0.145"	-	1000
MNG18-250DFK	054007-02369	22 - 18 AWG	0.250"	0.032"	0.86"	0.080"	0.145"	-	1000
MNG18-250DFX	051128-58789	22 - 18 AWG	0.250"	0.032"	0.86"	0.080"	0.145"	100	500
MNG14-110DFK-A	051128-57437	16 - 14 AWG	0.110"	0.020"	0.77"	-	0.200"	-	1000
MNG14-187DFK	054007-01773	16 - 14 AWG	0.187"	0.020"	0.77"	0.085"	0.145"	-	1000
MNG14-187DFX	051128-58672	16 - 14 AWG	0.187"	0.020"	0.77"	0.085"	0.145"	100	500
MNG14-250DFK	054007-01774	16 - 14 AWG	0.250"	0.032"	0.86"	0.080"	0.145"	-	1000
MNG14-250DFX	051128-58673	16 - 14 AWG	0.250"	0.032"	0.86"	0.080"	0.145"	100	500
MNG10-375DFK	054007-02053	12 - 10 AWG	0.375"	0.050"	1.23"	0.175"	0.250"	-	500

Vinyl Insulated Interlock Barrel Female Disconnects

Terminal Type	Disconnect
Terminal Style	Standard
Fastener Orientation	Female
Insulation Material	Vinyl
Barrel Style	Interlocking Barrel
RoHS 2011/65/EU	Yes
Agency Approval	
Manufacturing Origin	

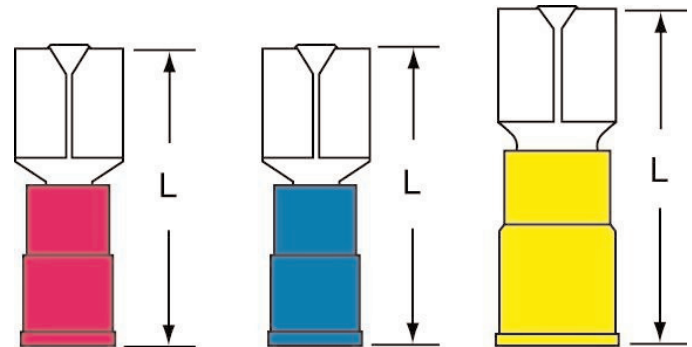

Order No.	UPC	Conductor Size	Mates with Male Tab Width (W')	Thickness	(L)	Barrel I.D.	Max. Insul. Dia.	Terminals per Carton	Terminals per Case
MVI18-250DFX	051128-58935	22 - 18 AWG	0.250"	0.032"	0.83"	0.076"	0.145"	100	500
MVI18-250DFK	054007-69582	22 - 18 AWG	0.250"	0.032"	0.83"	0.076"	0.145"	-	1000
MVI14-250DFX	051128-58938	16 - 14 AWG	0.250"	0.032"	0.83"	0.076"	0.145"	100	500
MVI14-250DFK	054007-69580	16 - 14 AWG	0.250"	0.032"	0.83"	0.076"	0.145"	-	1000
MVI10-250DFX	051128-58936	12 - 10 AWG	0.250"	0.032"	0.95"	0.128"	0.250"	50	500
MVI10-250DFK	054007-69578	12 - 10 AWG	0.250"	0.032"	0.95"	0.128"	0.250"	-	500

Vinyl Insulated with Insulation Grip Female Disconnects

Terminal Type	Disconnect
Terminal Style	Standard
Fastener Orientation	Female
Insulation Material	Vinyl with Insulation Grip
Barrel Style	Butted
RoHS 2011/65/EU	Yes
Manufacturing Origin	



Order No.	UPC	Conductor Size	Mates with Male Tab Width (W')	Thickness	(L)	Barrel I.D.	Max. Insul. Dia.	Terminals per Carton	Terminals per Case
MVG24-110/32DFX	051128-58998	26 - 24 AWG	0.110"	0.032"	0.63"	0.055"	0.093"	100	500
MVG24-110DFK	054007-95151	26 - 24 AWG	0.110"	0.020"	0.63"	0.055"	0.093"	-	1000

Vinyl Insulated Butted Seam Female Disconnects

Terminal Type	Disconnect
Terminal Style	Standard
Fastener Orientation	Female
Insulation Material	Vinyl
Barrel Style	Butted
RoHS 2011/65/EU	Yes
Agency Approval	 Except for 110DF Female Disconnects
Manufacturing Origin	 Product numbers ending with "-A" are made in Taiwan.



Order No.	UPC	Conductor Size	Mates with Male Tab Width (W')	Thickness	(L)	Barrel I.D.	Max. Insul. Dia.	Terminals per Carton	Terminals per Case
MVU18-187DFX	051128-59013	22 - 18 AWG	0.187"	0.020"	0.78"	0.085"	0.145"	100	500
MVU18-187DFK	054007-02368	22 - 18 AWG	0.187"	0.020"	0.78"	0.085"	0.145"	-	1000
MVU18-250DFX	051128-58790	22 - 18 AWG	0.250"	0.032"	0.87"	0.080"	0.145"	100	500
MVU18-250DFK	054007-01301	22 - 18 AWG	0.250"	0.032"	0.87"	0.080"	0.145"	-	1000
MVU14-110DFK-A	051128-57438	16 - 14 AWG	0.110"	0.020"	0.73"	-	0.180"	-	1000
MVU14-187DFX	051128-58670	16 - 14 AWG	0.187"	0.020"	0.78"	0.085"	0.145"	100	500
MVU14-187DFK	054007-01776	16 - 14 AWG	0.187"	0.020"	0.78"	0.085"	0.145"	-	1000
MVU14-250DFX	051128-58671	16 - 14 AWG	0.250"	0.032"	0.87"	0.080"	0.145"	100	500
MVU14-250DFK	054007-01777	16 - 14 AWG	0.250"	0.032"	0.87"	0.080"	0.145"	-	1000
MVU10-375DFK	054007-02055	12 - 10 AWG	0.375"	0.050"	1.23"	0.175"	0.250"	-	500

Non-Insulated Interlock Barrel Female Disconnects

Terminal Type Disconnect
 Terminal Style Standard
 Fastener Orientation Female
 Insulation Material Non-Insulated
 Barrel Style Interlocking Barrel
 RoHS 2011/65/EU Yes

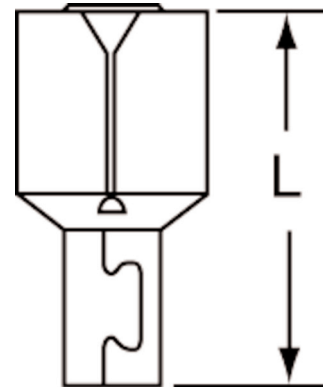
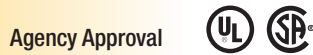

Order No.	UPC	Conductor Size	Mates with Male Tab Width (W')	(L)	Thickness	Barrel I.D.	Terminals per Carton	Terminals per Case
MI18-250DFK	054007-69561	22 - 18 AWG	0.250"	0.63"	0.032"	0.076"	-	1000
MI10-250DFX	051128-58860	12 - 10 AWG	0.250"	0.64"	0.032"	0.128"	50	500
MI10-250DFK	054007-69557	12 - 10 AWG	0.250"	0.64"	0.032"	0.128"	-	500

Non-Insulated Butted Seam Female Disconnects

Terminal Type Disconnect
 Terminal Style Standard
 Fastener Orientation Female
 Insulation Material Non-Insulated
 Barrel Style Butted
 RoHS 2011/65/EU Yes

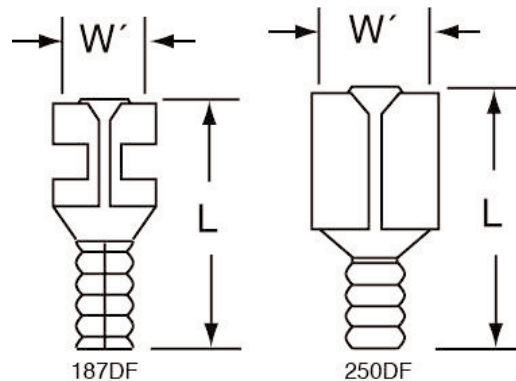

Order No.	UPC	Conductor Size	Mates with Male Tab Width (W')	(L)	Thickness	Barrel I.D.	Terminals per Carton	Terminals per Case
MU20-110/32DFK-A	051128-57616	26 - 20 AWG	0.110"	0.48"	0.032"	0.040"	-	1000
MU18-187DFX	051128-59014	22 - 18 AWG	0.187"	0.58"	0.020"	0.085"	100	500
MU18-187DFK	054007-02366	22 - 18 AWG	0.187"	0.58"	0.020"	0.085"	-	1000
MU18-250DFX	051128-58788	22 - 18 AWG	0.250"	0.66"	0.032"	0.080"	100	500
MU18-250DFK	054007-01300	22 - 18 AWG	0.250"	0.66"	0.032"	0.080"	-	1000
MU14-110DFX	051128-58706	16 - 14 AWG	0.110"	0.54"	0.020"	0.115"	100	500
MU14-110DFK	054007-13995	16 - 14 AWG	0.110"	0.54"	0.020"	0.115"	-	1000
MU14-187DFK	054007-01767	16 - 14 AWG	0.187"	0.58"	0.020"	0.085"	-	1000

Non-Insulated Butted Seam Female Disconnects (continued)

Order No.	UPC	Conductor Size	Mates with Male Tab Width (W')	(L)	Thickness	Barrel I.D.	Terminals per Carton	Terminals per Case
MU14-187DFX	051128-58707	16 - 14 AWG	0.187"	0.58"	0.020"	0.085"	100	500
MU14-250DFX	051128-58708	16 - 14 AWG	0.250"	0.66"	0.032"	0.080"	100	500
MU14-250DFK	054007-01768	16 - 14 AWG	0.250"	0.66"	0.032"	0.080"	-	1000

Non-Insulated Butted Seam Flag Female Disconnects

Terminal Type Disconnect
Terminal Style Flag
Fastener Orientation Female
Insulation Material Non-Insulated
Barrel Style Butted
RoHS 2011/65/EU Yes

Agency Approval

 Except for 187DF Flag Female Disconnects

Manufacturing Origin



Order No.	UPC	Conductor Size	Mates with Male Tab Width (W')	(L)	Thickness	Barrel I.D.	Terminals per Carton	Terminals per Case
MU18-187DF/FLAGX	051128-59092	22 - 18 AWG	0.187"	0.46"	0.020"	0.075"	100	500
MU18-187DF/FLAGK	054007-01302	22 - 18 AWG	0.187"	0.46"	0.020"	0.075"	-	1000
MU18-250DF/FLAGX	051128-59091	22 - 18 AWG	0.250"	0.50"	0.032"	0.075"	100	500
MU18-250DF/FLAGK	054007-01303	22 - 18 AWG	0.250"	0.66"	0.032"	0.080"	-	1000
MU14-187DF/FLAGX	051128-59089	16 - 14 AWG	0.187"	0.47"	0.020"	0.095"	100	500
MU14-187DF/FLAGK	054007-01778	16 - 14 AWG	0.187"	0.47"	0.020"	0.095"	-	1000
MU14-250DF/FLAGX	051128-59090	16 - 14 AWG	0.250"	0.51"	0.032"	0.095"	100	500
MU14-250DF/FLAGK	054007-01779	16 - 14 AWG	0.250"	0.51"	0.032"	0.095"	-	1000

Heat Shrink Nylon Fully Insulated Butted Seam Male Disconnects

Terminal Type	Disconnect
Terminal Style	Fully Insulated
Fastener Orientation	Male
Insulation Material	Heat Shrink
Barrel Style	Butted
RoHS 2011/65/EU	Yes
Manufacturing Origin	

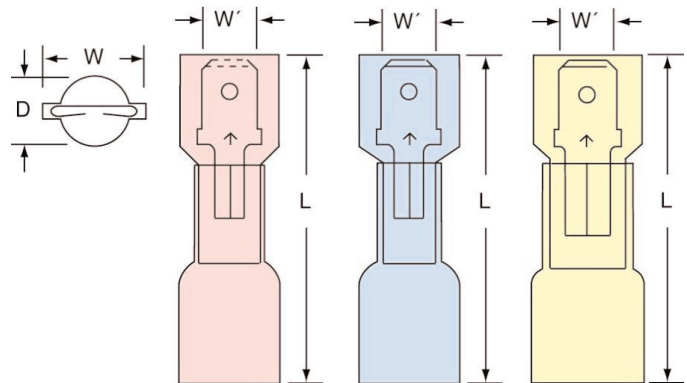

Order No.	UPC	Conductor Size	Male Tab Width (W')	(L)	(W)	Diameter (D)	Thickness	Barrel I.D.	Terminals per Carton	Terminals per Case
MNHU18-250DMIX	051128-58917	22 - 18 AWG	0.250"	1.20"	0.44"	0.30"	0.032"	0.065"	25	125
MNHU18-250DMIK	054007-06357	22 - 18 AWG	0.250"	1.20"	0.44"	0.30"	0.032"	0.065"	-	250
MNHU14-250DMIX	051128-58908	16 - 14 AWG	0.250"	1.20"	0.44"	0.30"	0.032"	0.085"	25	125
MNHU14-250DMIK	054007-06341	16 - 14 AWG	0.250"	1.20"	0.44"	0.30"	0.032"	0.085"	-	250
MNHU10-250DMIX	051128-58896	12 - 10 AWG	0.250"	1.20"	0.47"	0.39"	0.032"	0.150"	25	125
MNHU10-250DMIK	054007-06317	12 - 10 AWG	0.250"	1.20"	0.47"	0.39"	0.032"	0.150"	-	250

Nylon Fully Insulated with Insulation Grip Male Disconnects

Terminal Type	Disconnect
Terminal Style	Fully Insulated
Fastener Orientation	Male
Insulation Material	Nylon with Insulation Grip
Barrel Style	Butted
RoHS 2011/65/EU	Yes
Agency Approval	
Manufacturing Origin	

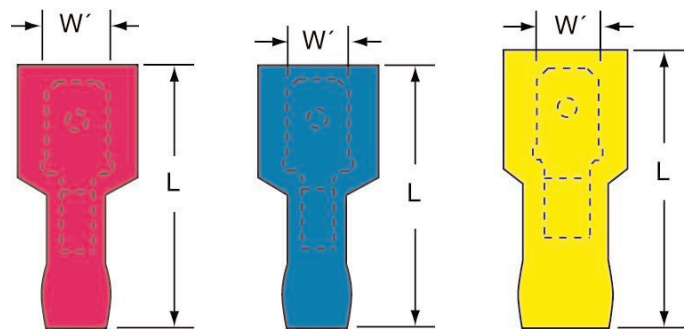

Order No.	UPC	Conductor Size	Male Tab Width (W')	(L)	(W)	Diameter (D)	Thickness	Barrel I.D.	Terminals per Carton	Terminals per Case
MNG18-187DMIX	051128-58807	22 - 18 AWG	0.187"	0.87"	0.37"	0.30"	0.020"	0.145"	100	500
MNG18-187DMIK	054007-11794	22 - 18 AWG	0.187"	0.87"	0.37"	0.30"	0.020"	0.145"	-	1000
MNG18-250DMIX	051128-58803	22 - 18 AWG	0.250"	0.95"	0.44"	0.30"	0.032"	0.145"	50	500
MNG18-250DMIK	054007-02302	22 - 18 AWG	0.250"	0.95"	0.44"	0.30"	0.032"	0.145"	-	1000
MNG14-187DMIX	051128-58799	16 - 14 AWG	0.187"	0.87"	0.37"	0.30"	0.020"	0.145"	100	500
MNG14-187DMIK	054007-02386	16 - 14 AWG	0.187"	0.87"	0.37"	0.30"	0.020"	0.145"	-	1000
MNG14-250DMIX	051128-58774	16 - 14 AWG	0.250"	0.95"	0.44"	0.30"	0.032"	0.170"	50	500

Nylon Fully Insulated with Insulation Grip Male Disconnects (continued)

Order No.	UPC	Conductor Size	Male Tab Width (W')	(L)	(W)	Diameter (D)	Thickness	Barrel I.D.	Terminals per Carton	Terminals per Case
MNG14-250DMIK	054007-02249	16 - 14 AWG	0.250"	0.95"	0.44"	0.30"	0.032"	0.170"	-	1000
MNG10-250DMIX	051128-58793	12 - 10 AWG	0.250"	1.05"	0.47"	0.39"	0.032"	0.250"	50	500
MNG10-250DMIK	054007-02303	12 - 10 AWG	0.250"	1.05"	0.47"	0.39"	0.032"	0.250"	-	500

Nylon Fully Insulated Butted Seam Male Disconnects

Terminal Type Disconnect
Terminal Style Fully Insulated
Fastener Orientation Male
Insulation Material Nylon
Barrel Style Butted
RoHS 2011/65/EU Yes
Agency Approval 
Manufacturing Origin 



Order No.	UPC	Conductor Size	Male Tab Width (W')	(L)	(W)	Diameter (D)	Thickness	Barrel I.D.	Max. Insul. Dia.	Terminals per Carton	Terminals per Case
MNU18-187DMIX	051128-58784	22 - 18 AWG	0.187"	0.87"	0.37"	0.30"	0.020"	0.080"	0.145"	100	500
MNU18-187DMIK	054007-02379	22 - 18 AWG	0.187"	0.87"	0.37"	0.30"	0.020"	0.080"	0.145"	-	1000
MNU18-250DMIX	051128-58778	22 - 18 AWG	0.250"	0.95"	0.44"	0.30"	0.032"	0.065"	0.145"	50	500
MNU18-250DMIK	054007-02299	22 - 18 AWG	0.250"	0.95"	0.44"	0.30"	0.032"	0.065"	0.145"	-	1000
MNU14-187DMIX	051128-58786	16 - 14 AWG	0.187"	0.87"	0.37"	0.30"	0.020"	0.080"	0.145"	100	500
MNU14-187DMIK	054007-02385	16 - 14 AWG	0.187"	0.87"	0.37"	0.30"	0.020"	0.080"	0.145"	-	1000
MNU14-250DMIK	054007-02300	16 - 14 AWG	0.250"	0.95"	0.44"	0.30"	0.032"	0.085"	0.170"	-	1000
MNU14-250DMIX	051128-58779	16 - 14 AWG	0.250"	0.95"	0.44"	0.30"	0.032"	0.085"	0.170"	50	500
MNU10-250DMIX	051128-58780	12 - 10 AWG	0.250"	1.05"	0.47"	0.39"	0.032"	0.150"	0.250"	50	500
MNU10-250DMIK	054007-02301	12 - 10 AWG	0.250"	1.05"	0.47"	0.39"	0.032"	0.150"	0.250"	-	500

Nylon Insulated with Insulation Grip Male Disconnects

Terminal Type Disconnect
 Terminal Style Standard
 Fastener Orientation Male
 Insulation Material Nylon
 Barrel Style Insulation Grip
 RoHS 2011/65/EU Yes
 Agency Approval 

Manufacturing Origin 
 With U.S. and Global Content



Order No.	UPC	Conductor Size	Male Tab Width (W')	(L)	Thickness	Barrel I.D.	Max. Insul. Dia.	Terminals per Carton	Terminals per Case
MNG18-187DMK	054007-02377	22 - 18 AWG	0.187"	0.84"	0.020"	0.080"	0.145"	-	1000
MNG18-250DMX	051128-58785	22 - 18 AWG	0.250"	0.92"	0.032"	0.065"	0.145"	100	500
MNG18-250DMK	054007-02378	22 - 18 AWG	0.250"	0.92"	0.032"	0.065"	0.145"	-	1000
MNG14-187DMX	051128-58677	16 - 14 AWG	0.187"	0.84"	0.020"	0.080"	0.145"	100	500
MNG14-187DMK	054007-01787	16 - 14 AWG	0.187"	0.84"	0.020"	0.080"	0.145"	-	1000
MNG14-250DMX	051128-58678	16 - 14 AWG	0.250"	0.94"	0.032"	0.085"	0.170"	100	500
MNG14-250DMK	054007-01788	16 - 14 AWG	0.250"	0.94"	0.032"	0.085"	0.170"	-	1000
MNG10-250DMX	051128-58721	12 - 10 AWG	0.250"	1.05"	0.032"	0.150"	0.250"	50	500
MNG10-250DMK	054007-02058	12 - 10 AWG	0.250"	1.05"	0.032"	0.150"	0.250"	-	500



Nylon Insulated with Insulation Grip Bullet Style Male Disconnects

Terminal Type Disconnect
 Terminal Style Bullet Snap Plug
 Fastener Orientation Male
 Insulation Material Nylon
 Barrel Style Insulation Grip
 RoHS 2011/65/EU Yes
 Manufacturing Origin Taiwan



Order No.	UPC	Conductor Size	Mating Snap Diameter (S)	(L)	Max. Insul. Dia.	Terminals per Carton	Terminals per Case
MNG18-156DMK-A	051138-98088	22 - 18 AWG	0.156"	0.87"	0.150"	-	1000
MNG18-180DMK-A	051138-98100	22 - 18 AWG	0.180"	0.87"	0.150"	-	1000
MNG14-156DMK-A	051138-98137	16 - 14 AWG	0.156"	0.87"	0.190"	-	1000
MNG14-156DMX-A	051128-58868	16 - 14 AWG	0.156"	0.87"	0.190"	100	500

Vinyl Insulated Butted Seam Male Disconnects

Terminal Type	Disconnect
Terminal Style	Standard
Fastener Orientation	Male
Insulation Material	Vinyl
Barrel Style	Butted
RoHS 2011/65/EU	Yes
Agency Approval	
Manufacturing Origin	

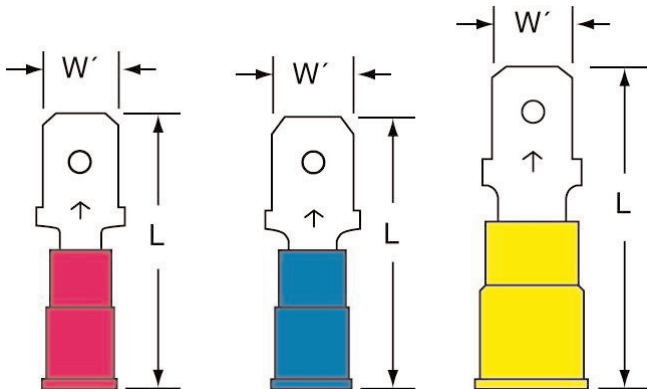

Order No.	UPC	Conductor Size	Male Tab Width (W')	(L)	Thickness	Barrel I.D.	Max. Insul. Dia.	Terminals per Carton	Terminals per Case
MVU18-187DMX	051128-59012	22 - 18 AWG	0.187"	0.85"	0.020"	0.080"	0.145"	100	500
MVU18-187DMK	054007-02375	22 - 18 AWG	0.187"	0.85"	0.020"	0.080"	0.145"	-	1000
MVU18-250DMX	051128-58782	22 - 18 AWG	0.250"	0.93"	0.032"	0.065"	0.145"	100	500
MVU18-250DMK	054007-02376	22 - 18 AWG	0.250"	0.93"	0.032"	0.065"	0.145"	-	1000
MVU14-187DMX	051128-58674	16 - 14 AWG	0.187"	0.85"	0.020"	0.080"	0.145"	100	500
MVU14-187DMK	054007-01789	16 - 14 AWG	0.187"	0.85"	0.020"	0.080"	0.145"	-	1000
MVU14-250DMX	051128-58676	16 - 14 AWG	0.250"	0.93"	0.032"	0.085"	0.170"	100	500
MVU14-250DMK	054007-01790	16 - 14 AWG	0.250"	0.93"	0.032"	0.085"	0.170"	-	1000
MVU10-250DMX	051128-58675	12 - 10 AWG	0.250"	1.05"	0.032"	0.150"	0.250"	50	500
MVU10-250DMK	054007-02059	12 - 10 AWG	0.250"	1.05"	0.032"	0.150"	0.250"	-	500

Vinyl Insulated Butted Seam Bullet Style Male Disconnects

Terminal Type	Disconnect
Terminal Style	Bullet Snap Plug
Fastener Orientation	Male
Insulation Material	Vinyl
Barrel Style	Butted
RoHS 2011/65/EU	Yes
Manufacturing Origin	Taiwan

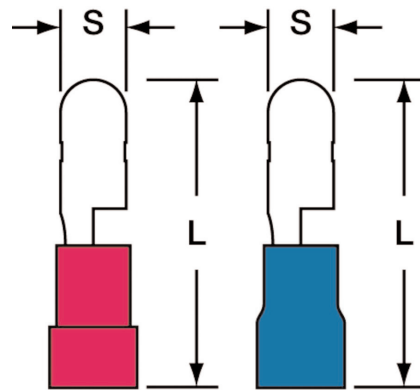

Order No.	UPC	Conductor Size	Mating Snap Diameter (S)	(L)	Max. Insul. Dia.	Terminals per Carton	Terminals per Case
MVU18-156DMK-A	051138-98094	22 - 18 AWG	0.156"	0.83"	0.150"	-	1000
MVU18-180DMK-A	051138-98104	22 - 18 AWG	0.180"	0.83"	0.150"	-	1000
MVU14-156DMK-A	051138-98149	16 - 14 AWG	0.156"	0.83"	0.170"	-	1000
MVU14-156DMX-A	051128-58867	16 - 14 AWG	0.156"	0.83"	0.170"	100	500
MVU14-180DMK-A	051138-98162	16 - 14 AWG	0.180"	0.83"	0.170"	-	1000
MVU14-180DMX-A	051128-58866	16 - 14 AWG	0.180"	0.83"	0.170"	100	500

Non-Insulated Butted Seam Male Disconnects

Terminal Type Disconnect
 Terminal Style Standard
 Fastener Orientation Male
 Insulation Material Non-Insulated
 Barrel Style Butted
 RoHS 2011/65/EU Yes



Order No.	UPC	Conductor Size	Male Tab Width (W')	(L)	Thickness	Barrel I.D.	Terminals per Carton	Terminals per Case
MU18-187DMX	051128-59009	22 - 18 AWG	0.187"	0.64"	0.020"	0.080"	100	500
MU18-187DMK	054007-02372	22 - 18 AWG	0.187"	0.64"	0.020"	0.080"	-	1000
MU18-250DMX	051128-59010	22 - 18 AWG	0.250"	0.73"	0.032"	0.065"	100	500
MU18-250DMK	054007-02364	22 - 18 AWG	0.250"	0.73"	0.032"	0.065"	-	1000
MU14-187DMX	051128-59011	16 - 14 AWG	0.187"	0.64"	0.020"	0.080"	100	500
MU14-187DMK	054007-01783	16 - 14 AWG	0.187"	0.64"	0.020"	0.080"	-	1000
MU14-250DMX	051128-58709	16 - 14 AWG	0.250"	0.73"	0.032"	0.085"	100	500
MU14-250DMK	054007-01784	16 - 14 AWG	0.250"	0.73"	0.032"	0.085"	-	1000
MU10-250DMX	051128-58691	12 - 10 AWG	0.250"	0.75"	0.032"	0.150"	50	500
MU10-250DMK	054007-02056	12 - 10 AWG	0.250"	0.75"	0.032"	0.150"	-	500

Nylon Insulated with Insulation Grip Piggy-Back Disconnects

Terminal Type	Disconnect
Terminal Style	Piggy-Back
Fastener Orientation	Male-Female
Insulation Material	Nylon
Barrel Style	Insulation Grip
RoHS 2011/65/EU	Yes
Manufacturing Origin	Taiwan



Order No.	UPC	Conductor Size	Mates with Male Tab Width (W')	(L)	Thickness	Max. Insul. Dia.	Term. per Carton	Term. per Case
MNG18-250DMFX-A	051138-98059	22 - 18 AWG	0.250"	0.91"	0.032"	0.150"	50	500
MNG14-250DMFK-A	051138-98067	16 - 14 AWG	0.250"	0.91"	0.032"	0.190"	-	1000
MNG14-250DMFX-A	051128-58873	16 - 14 AWG	0.250"	0.91"	0.032"	0.190"	100	500

Vinyl Insulated Butted Seam Piggy-Back Disconnects

Terminal Type	Disconnect
Terminal Style	Piggy-Back
Fastener Orientation	Male-Female
Insulation Material	Vinyl
Barrel Style	Butted
RoHS 2011/65/EU	Yes
Manufacturing Origin	Taiwan



Order No.	UPC	Conductor Size	Mates with Male Tab Width (W')	(L)	Thickness	Barrel Length	Barrel I.D.	Max. Insul. Dia.	Term. per Carton	Term. per Case
MVU18-250DMFX-A	051128-58874	22 - 18 AWG	0.250"	0.87"	0.032"	0.23"	0.070"	0.150"	100	500
MVU18-250DMFK-A	051138-98062	22 - 18 AWG	0.250"	0.87"	0.032"	0.23"	0.070"	0.150"	-	1000
MVU14-250DMFX-A	051128-58872	16 - 14 AWG	0.250"	0.87"	0.032"	0.23"	0.090"	0.170"	100	500
MVU14-250DMFK-A	051138-98073	16 - 14 AWG	0.250"	0.87"	0.032"	0.23"	0.090"	0.170"	-	1000

Non-Insulated Double Male-Female Adapters

Terminal Type Disconnect
Terminal Style Adapter
Fastener Orientation Double Male-Female
Insulation Material Non-Insulated
Barrel Style Butted
RoHS 2011/65/EU Yes

Agency Approval  Except for MA250DMFM-A Adapters

Manufacturing Origin  Product numbers ending with "-A" are made in Taiwan.



Order No.	UPC	Mates with Female and Male Tab Width (W')	(L)	Thickness	Terminals per Carton	Terminals per Case
MA250DMFMK-A	051128-57451	0.250"	0.70"	0.032"	-	500
MA250DMFMX-A	051128-58875	0.250"	0.70"	0.032"	100	500
MA250DMMFK	054007-02273	0.250"	0.76"	0.032"	-	500
MA250DMMFX	051128-58781	0.250"	0.76"	0.032"	50	500

Butted Seam 900°F (482°C) High Temperature Ring Tongues

Terminal Type	Ring
Terminal Style	High Temperature
Insulation Material	Non-Insulated
Barrel Style	Butted
RoHS 2011/65/EU	Yes
Manufacturing Origin	



Order No.	UPC	Conductor Size	Stud Size	(W)	(C)	(L)	(E)	Thickness	Barrel I.D.	Terminals per Carton	Terminals per Case
MU18-6RHT/SX	051128-58955	22 - 18 AWG	6	0.25"	0.22"	0.60"	0.47"	0.030"	0.070"	100	500
MU18-10RHTX	051128-58956	22 - 18 AWG	10	0.33"	0.29"	0.70"	0.54"	0.030"	0.070"	100	500
MU18-10RHTK	054007-01155	22 - 18 AWG	10	0.33"	0.29"	0.70"	0.54"	0.030"	0.070"	-	1000
MU14-6RHT/SX	051128-58975	16 - 14 AWG	6	0.25"	0.22"	0.60"	0.47"	0.030"	0.090"	100	500
MU14-6RHT/SK	054007-01758	16 - 14 AWG	6	0.25"	0.22"	0.60"	0.47"	0.030"	0.090"	-	1000
MU14-10RHTX	051128-58771	16 - 14 AWG	10	0.33"	0.29"	0.70"	0.54"	0.030"	0.090"	100	500
MU14-10RHTK	054007-01759	16 - 14 AWG	10	0.33"	0.29"	0.70"	0.54"	0.030"	0.090"	-	1000
MU14-14RHTX	051128-58976	16 - 14 AWG	1/4"	0.56"	0.40"	0.93"	0.65"	0.030"	0.090"	100	500
MU14-14RHTK	054007-01760	16 - 14 AWG	1/4"	0.56"	0.40"	0.93"	0.65"	0.030"	0.090"	-	1000
MU10-10RHTX	051128-58772	12 - 10 AWG	10	0.38"	0.29"	0.73"	0.54"	0.040"	0.135"	50	500
MU10-10RHTK	054007-02045	12 - 10 AWG	10	0.38"	0.29"	0.73"	0.54"	0.040"	0.135"	-	500
MU10-14RHTK	054007-02046	12 - 10 AWG	1/4"	0.59"	0.44"	0.99"	0.69"	0.040"	0.135"	-	500
MU8-14RHT/SK	054007-02142	8 AWG	1/4"	0.47"	0.40"	0.95"	0.71"	0.050"	0.185"	-	200
MU6-38RHTK	054007-02171	6 AWG	3/8"	0.63"	0.52"	1.22"	0.91"	0.050"	0.255"	-	200
MU4-38RHTK	054007-02196	4 AWG	3/8"	0.68"	0.53"	1.34"	1.00"	0.075"	0.285"	-	200

Butted Seam 900°F (482°C) High Temperature Standard Forks

Terminal Type	Fork
Terminal Style	High Temperature
Insulation Material	Non-Insulated
Barrel Style	Butted
RoHS 2011/65/EU	Yes
Manufacturing Origin	

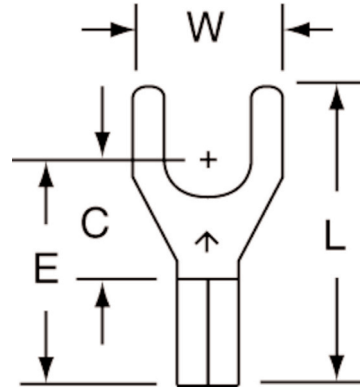

Order No.	UPC	Conductor Size	Stud Size	(W)	(C)	(L)	(E)	Thickness	Barrel I.D.	Terminals per Carton	Terminals per Case
MU18-10FHTK	054007-01333	22 - 18 AWG	10	0.34"	0.29"	0.70"	0.54"	0.030"	0.070"	-	1000
MU14-10FHTK	054007-01842	16 - 14 AWG	10	0.34"	0.29"	0.70"	0.54"	0.030"	0.090"	-	1000
MU10-10FHTK	054007-02095	12 - 10 AWG	10	0.38"	0.28"	0.73"	0.53"	0.040"	0.135"	-	500

Butted Seam 900°F (482°C) High Temperature Block Forks

Terminal Type	Fork
Terminal Style	High Temperature Block
Insulation Material	Non-Insulated
Barrel Style	Butted
RoHS 2011/65/EU	Yes
Manufacturing Origin	

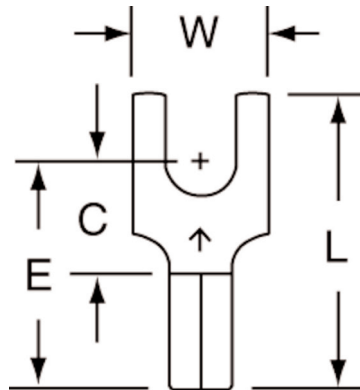

Order No.	UPC	Conductor Size	Stud Size	(W)	(C)	(L)	(E)	Thickness	Barrel I.D.	Terminals per Carton	Terminals per Case
MU18-6FBHTK	054007-01334	22 - 18 AWG	6	0.30"	0.25"	0.65"	0.50"	0.030"	0.070"	-	1000
MU14-6FBHTK	054007-01843	16 - 14 AWG	6	0.30"	0.25"	0.65"	0.50"	0.030"	0.090"	-	1000

Butted Seam 900°F (482°C) High Temperature Butt Connectors

Terminal Type	Butt
Terminal Style	High Temperature
Insulation Material	Non-Insulated
Barrel Style	Butted
RoHS 2011/65/EU	Yes
Manufacturing Origin	

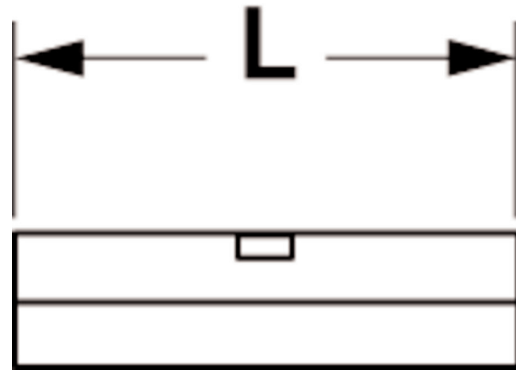

Order No.	UPC	Conductor Size	(L)	Thickness	Barrel Length	Barrel I.D.	Terminals per Carton	Terminals per Case
MU18BCHTX	051128-58957	22 - 18 AWG	0.56"	0.030"	0.25"	0.070"	100	500
MU18BCHTK	054007-01299	22 - 18 AWG	0.56"	0.030"	0.25"	0.070"	-	1000
MU14BCHTX	051128-58977	16 - 14 AWG	0.56"	0.030"	0.25"	0.090"	100	500
MU14BCHTK	054007-01761	16 - 14 AWG	0.56"	0.030"	0.25"	0.090"	-	1000
MU10BCHTX	051128-58989	12 - 10 AWG	0.56"	0.040"	0.25"	0.135"	50	500
MU10BCHTK	054007-02232	12 - 10 AWG	0.56"	0.040"	0.25"	0.135"	-	500

Butted Seam 900°F (482°C) High Temperature Female Disconnects

Terminal Type	Disconnect
Terminal Style	High Temperature
Fastener Orientation	Female
Insulation Material	Non-Insulated
Barrel Style	Butted
RoHS 2011/65/EU	Yes
Manufacturing Origin	



Order No.	UPC	Conductor Size	Mates with Male Tab Width (W')	(L)	Thickness	Barrel Length	Barrel I.D.	Terminals per Carton	Terminals per Case
MU14-187DFHTK	054007-01762	16 - 14 AWG	0.187"	0.58"	0.020"	0.25"	0.085"	-	1000
MU14-250DFHTK	054007-01763	16 - 14 AWG	0.250"	0.64"	0.032"	0.23"	0.095"	-	1000
MU14-250DFHTX	051128-58978	16 - 14 AWG	0.250"	0.64"	0.032"	0.23"	0.095"	100	500

Butted Seam Flag 900°F (482°C) High Temperature Female Disconnects

Terminal Type	Disconnect
Terminal Style	High Temperature Flag
Fastener Orientation	Female
Insulation Material	Non-Insulated
Barrel Style	Butted
RoHS 2011/65/EU	Yes
Manufacturing Origin	



Order No.	UPC	Conductor Size	Mates with Male Tab Width (W')	(L)	Thickness	Barrel Length	Barrel I.D.	Terminals per Carton	Terminals per Case
MU14-250DFHT/FLAGK	054007-01839	16 - 14 AWG	0.250"	0.51"	0.032"	0.26"	0.095"	-	1000

Butted Seam 900°F (482°C) High Temperature Male Disconnects

Terminal Type	Disconnect
Terminal Style	High Temperature
Fastener Orientation	Male
Insulation Material	Non-Insulated
Barrel Style	Butted
RoHS 2011/65/EU	Yes
Manufacturing Origin	



Order No.	UPC	Conductor Size	Male Tab Width (W')	(L)	Thickness	Barrel Length	Barrel I.D.	Terminals per Carton	Terminals per Case
MU14-250DMHTX	051128-58979	16 - 14 AWG	0.250"	0.73"	0.032"	0.25"	0.090"	100	500
MU14-250DMHTK	054007-01765	16 - 14 AWG	0.250"	0.73"	0.032"	0.25"	0.090"	-	1000

Nylon Insulated with Insulation Grip Pin Terminals

Terminal Type	Pin
Insulation Material	Nylon
Barrel Style	Insulation Grip
RoHS 2011/65/EU	Yes
Manufacturing Origin	Taiwan



Order No.	UPC	Conductor Size	(L)	Pin Length (PL)	Pin Diameter	Max. Insul. Dia.	Terminals per Carton	Terminals per Case
MNG18-47PX-A	051128-58845	22 - 18 AWG	0.90"	0.47"	0.075"	0.170"	100	500
MNG14-47PK-A	051138-98166	16 - 14 AWG	0.90"	0.47"	0.075"	0.200"	-	1000
MNG14-47PX-A	051128-58775	16 - 14 AWG	0.90"	0.47"	0.075"	0.200"	100	500
MNG10-55PK-A	051138-98177	12 - 10 AWG	1.06"	0.55"	0.110"	0.270"	-	500
MNG10-55PX-A	051128-58864	12 - 10 AWG	1.06"	0.55"	0.110"	0.270"	50	500

Vinyl Insulated Butted Seam Pin Terminals

Terminal Type	Pin
Insulation Material	Vinyl
Barrel Style	Butted
RoHS 2011/65/EU	Yes
Manufacturing Origin	Taiwan



Order No.	UPC	Conductor Size	(L)	Max. Insul. Dia.	Pin Length (PL)	Pin Diameter	Terminals per Carton	Terminals per Case
MVU18-47PX-A	051128-58871	22 - 18 AWG	0.90"	0.150"	0.47"	0.075"	100	500
MVU18-47PK-A	051138-98111	22 - 18 AWG	0.90"	0.150"	0.47"	0.075"	-	1000
MVU14-47PX-A	051128-58865	16 - 14 AWG	0.90"	0.170"	0.47"	0.075"	100	500
MVU14-47PK-A	051138-98171	16 - 14 AWG	0.90"	0.170"	0.47"	0.075"	-	1000
MVU10-55PX-A	051128-58863	12 - 10 AWG	1.06"	0.250"	0.55"	0.110"	50	500
MVU10-55PK-A	051138-98182	12 - 10 AWG	1.06"	0.250"	0.55"	0.110"	-	500

Non-Insulated Butted Seam Pin Terminals

Terminal Type	Pin
Insulation Material	Non-Insulated
Barrel Style	Butted
RoHS 2011/65/EU	Yes
Manufacturing Origin	Taiwan



Order No.	UPC	Conductor Size	(L)	Pin Length (PL)	Pin Diameter	Terminals per Carton	Terminals per Case
MU18-47PX-A	051128-58877	22 - 18 AWG	0.73"	0.47"	0.080"	100	500
MU14-47PK-A	051128-57441	16 - 14 AWG	0.73"	0.47"	0.080"	-	1000
MU14-47PX-A	051128-58876	16 - 14 AWG	0.73"	0.47"	0.080"	100	500
MU10-55PX-A	051128-58754	12 - 10 AWG	0.81"	0.55"	0.110"	50	500

Closed End Connectors

3M™ Scotchlok™ electrical crimp sleeve connectors make fast work of splicing 22 to 10 AWG copper conductors. Smooth flared entry makes wire insertion fast — simply twist conductors together and crimp. The S-11-A and S-31-A connectors are insulated, closed-end crimp sleeve connectors with a copper insert. The rugged and resilient nylon insulator allows these connectors to be used in light fixtures, appliances and other electrical OEM applications.

Terminal Type	Closed End
Insulation Material	Nylon
Maximum Voltage	600 Volt
Maximum Operating Temperature (°F)	221 °F
Maximum Operating Temperature (°C)	105 °C
Manufacturing Origin	Taiwan



S-31

Order No.	UPC	Maximum Wire Gauge	Minimum Wire Gauge	(L)	Cu Solid/Stranded Wire Combinations	Terminals per Carton	Terminals per Case
S-11-A (BULK)	051138-98052	22 AWG	16 AWG	0.83"	2- 5 #22; 1-4 #22 with 1-2 #20; 1-3 #22 with 1 #18; 1 #22 with 1 #16; 2-3 #20	-	10000
S-11-A (BOXED)	051128-58997	22 AWG	16 AWG	0.83"	2-5 #22; 1-4 #22 with 1-2 #20; 1-3 #22 with 1 #18; 1 #22 with 1 #16; 2-3 #20	100	500
S-31-A (BULK)	051138-98044	18 AWG	10 AWG	1.00"	1 #22 with 1 #12 or #10; 1 #22 with 2 #14 or #16; 1 #22 with 1 #20 with 1 #12 or #14; 1 #22 with 1 #18 with 1 #12 or #14; 1 #22 with 1 #16 with 1 #12 or #14; 1 #22 with 1 #14 with 1 #12; 1-2 #20 with 1-2 #14; 1-2 #20 with 1 #12; 1 #20 with 1 #10; 1 #20 with 1 #16 with 1 #12; 1 #18 with 1 #14; 1 #18 with 1 #12; 1 #18 with 2 #16; 1 #18 with 1 #16 with 1 #12 or #14; 1 #16 with 1 #12 or #14; 3 #16; 1 #14 with 1 #12; 2 #14.	-	5000
S-31-A (BOXED)	051128-58996	18 AWG	10 AWG	1.00"	1 #22 with 1 #12 or #10; 1 #22 with 2 #14 or #16; 1 #22 with 1 #20 with 1 #12 or #14; 1 #22 with 1 #18 with 1 #12 or #14; 1 #22 with 1 #16 with 1 #12 or #14; 1 #22 with 1 #14 with 1 #12; 1-2 #20 with 1-2 #14; 1-2 #20 with 1 #12; 1 #20 with 1 #10; 1 #20 with 1 #16 with 1 #12; 1 #18 with 1 #14; 1 #18 with 1 #12; 1 #18 with 2 #16; 1 #18 with 1 #16 with 1 #12 or #14; 1 #16 with 1 #12 or #14; 3 #16; 1 #14 with 1 #12; 2 #14.	50	500

Vinyl Insulated Butted Seam Parallel Connectors

Terminal Type Parallel Connector
 Insulation Material Vinyl
 Barrel Style Butted
 RoHS 2011/65/EU Yes

Manufacturing Origin



Order No.	UPC	Conductor Size	(L)	Thickness	Barrel I.D.	Max. Insul. Dia.	Cu Stranded Wire Combinations	Terminals per Case	Terminals per Carton
MVU18PCK	054007-01318	22 - 18 AWG	0.67"	0.030"	0.070"	0.145"	1 #22 to 1 #22, 20, 18, 16; 1 #20 to 1 #20, 18, 16; 1 #18 to 1 #18	1000	
MVU14PCK	054007-01824	16 - 14 AWG	0.67"	0.030"	0.090"	0.170"	1 #22 to 1 #22, 20, 18, 16, 14; 1 #20 to 1 #20, 18, 16, 14; 1 #18 to 1 #18, 16, 14; 1 #16 to 1 #16.	1000	-
MVU10PCK	054007-02084	12 - 10 AWG	0.87"	0.040"	0.135"	0.250"	1 #18 to 1 #18, 16, 14, 12, 10; 1 #16 to 1 #16, 14, 12, 10; 1 #14 to 1 #14, 12.	500	-

3M™ Highland™ Terminals

3M Highland terminals, disconnects, and connectors are for use in the assembly and maintenance of electrical systems. 3M Highland terminals offer effective and reliable performance in a variety of types of general applications. Available in low quantity, reclosable bags, 3M Highland terminals are the optimal choice for smaller jobs.



Section	Page
3M™ Highland™ Terminals	71-77
3M™ Highland™ Ring Tongues.....	72
Vinyl Insulated Butted Seam – Ring Tongues.....	72
3M™ Highland™ Standard Forks.....	73
Vinyl Insulated Butted Seam – Standard Forks.....	73
3M™ Highland™ Block Forks	74
Vinyl Insulated Butted Seam – Block Forks	74
3M™ Highland™ Locking Forks.....	75
Vinyl Insulated Butted Seam – Locking Forks.....	75
3M™ Highland™ Butt Splices.....	75
Vinyl Insulated Butted Seam – Butt Splices.....	75
3M™ Highland™ Female Disconnects	76
Nylon Fully Insulated Butted Seam – Female Disconnects.....	76
Vinyl Insulated Butted Seam – Female Disconnects	76
3M™ Highland™ Male Disconnects.....	77
Nylon Fully Insulated Butted Seam – Male Disconnects	77
Vinyl Insulated Butted Seam – Male Disconnects.....	77

3M™ Highland™ Terminals: 3M™ Highland™ Ring Tongues

Vinyl Insulated Butted Seam – Ring Tongues

Terminal Type Ring
 Terminal Style Standard
 Insulation Material Vinyl
 Barrel Style Butted

RoHS 2011/65/EU Yes

Agency Approval



Manufacturing Origin

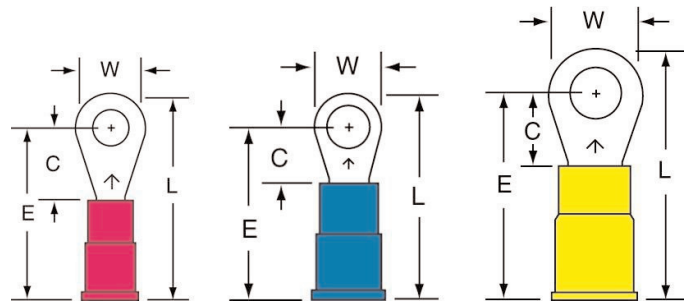

Order No.	UPC	Conductor Size	Stud Size	Terminals per Bag
RV18-6Q	051128-60045	22 - 18 AWG	6	25
RV18-10Q	051128-60043	22 - 18 AWG	10	25
RV18-8Q	051128-60046	22 - 18 AWG	8	25
RV18-14Q	051128-60044	22 - 18 AWG	1/4"	25
RV14-6Q	051128-60041	16 - 14 AWG	6	25
RV14-10Q	051128-60038	16 - 14 AWG	10	25
RV14-8Q	051128-60042	16 - 14 AWG	8	25
RV14-14Q	051128-60039	16 - 14 AWG	1/4"	25
RV14-516Q	051128-60040	16 - 14 AWG	5/16"	25
RV10-10Q	051128-60032	12 - 10 AWG	10	25
RV10-6Q	051128-60036	12 - 10 AWG	6	25
RV10-8Q	051128-60037	12 - 10 AWG	8	25
RV10-14Q	051128-60033	12 - 10 AWG	1/4"	25
RV10-516Q	051128-60035	12 - 10 AWG	5/16"	25
RV10-38Q	051128-60034	12 - 10 AWG	3/8"	25

Vinyl Insulated Butted Seam – Standard Forks

Terminal Type	Fork
Terminal Style	Standard
Insulation Material	Vinyl
Barrel Style	Butted
RoHS 2011/65/EU	Yes
Agency Approval	
Manufacturing Origin	



Order No.	UPC	Conductor Size	Stud Size	Terminals per Bag
FV14-6Q	051128-60012	16 - 14 AWG	6	25
FV14-8Q	051128-60013	16 - 14 AWG	8	25
FV14-10Q	051128-60011	16 - 14 AWG	10	25
FV10-8Q	051128-60010	12 - 10 AWG	8	25
FV10-10Q	051128-60009	12 - 10 AWG	10	25

Vinyl Insulated Butted Seam – Block Forks

Terminal Type Fork
 Terminal Style Block
 Insulation Material Vinyl
 Barrel Style Butted
 RoHS 2011/65/EU Yes

Agency Approval



Manufacturing Origin



Order No.	UPC	Conductor Size	Stud Size	Terminals per Bag
BFV18-6Q	051128-59994	22 - 18 AWG	6	25
BFV18-8Q	051128-59995	22 - 18 AWG	8	25
BFV18-10Q	051128-59993	22 - 18 AWG	10	25
BFV14-6Q	051128-59991	16 - 14 AWG	6	25
BFV14-8Q	051128-59992	16 - 14 AWG	8	25
BFV14-10Q	051128-59990	16 - 14 AWG	10	25
BFV10-6Q	051128-59988	12 - 10 AWG	6	25
BFV10-8Q	051128-59989	12 - 10 AWG	8	25
BFV10-10Q	051128-59987	12 - 10 AWG	10	25

3M™ Highland™ Terminals: 3M™ Highland™ Locking Forks

Vinyl Insulated Butted Seam – Locking Forks

Terminal Type Fork
Terminal Style Locking
Insulation Material Vinyl
Barrel Style Butted
RoHS 2011/65/EU Yes
Agency Approval 
Manufacturing Origin 



Order No.	UPC	Conductor Size	Stud Size	Terminals per Bag
LFV18-8Q	051128-60021	22 - 18 AWG	8	25
LFV18-6Q	051128-60020	22 - 18 AWG	6	25
LFV14-8Q	051128-60019	16 - 14 AWG	8	25
LFV14-6Q	051128-60018	16 - 14 AWG	6	25
LFV14-10Q	051128-60017	16 - 14 AWG	10	25
LFV10-6Q	051128-60015	12 - 10 AWG	6	25
LFV10-8Q	051128-60016	12 - 10 AWG	8	25
LFV10-10Q	051128-60014	12 - 10 AWG	10	25

3M™ Highland™ Terminals: 3M™ Highland™ Butt Splices

Vinyl Insulated Butted Seam – Butt Splices

Terminal Type Butt
Terminal Style Standard
Insulation Material Vinyl
Barrel Style Butted
RoHS 2011/65/EU Yes
Agency Approval 
Manufacturing Origin 



Order No.	UPC	Conductor Size	Terminals per Bag
BSV18Q	051128-59998	22 - 18 AWG	25
BSV14Q	051128-59997	16 - 14 AWG	25
BSV10Q	051128-59996	12 - 10 AWG	25



Nylon Fully Insulated Butted Seam – Female Disconnects

Terminal Type Disconnect
Terminal Style Fully Insulated
Fastener Orientation Female
Insulation Material Nylon
Barrel Style Butted
RoHS 2011/65/EU Yes
Agency Approval 
Manufacturing Origin 



Order No.	UPC	Conductor Size	Mates with Male Tab Width (W')	Terminals per Bag
FDI18-187Q	051128-60002	22 - 18 AWG	0.187"	25
FDI18-250Q	051128-60003	22 - 18 AWG	0.250"	25
FDI14-187Q	051128-60000	16 - 14 AWG	0.187"	25
FDI14-250Q	051128-60001	16 - 14 AWG	0.250"	25
FDI10-250Q	051128-59999	12 - 10 AWG	0.250"	25

Vinyl Insulated Butted Seam – Female Disconnects

Terminal Type Disconnect
Terminal Style Standard
Fastener Orientation Female
Insulation Material Vinyl
Barrel Style Butted
RoHS 2011/65/EU Yes
Agency Approval 
Manufacturing Origin 



Order No.	UPC	Conductor Size	Mates with Male Tab Width (W')	Terminals per Bag
FDV18-187Q	051128-60007	22 - 18 AWG	0.187"	25
FDV18-250Q	051128-60008	22 - 18 AWG	0.250"	25
FDV14-187Q	051128-60005	16 - 14 AWG	0.187"	25
FDV14-250Q	051128-60006	16 - 14 AWG	0.250"	25
FDV10-250Q	051128-60004	12 - 10 AWG	0.250"	25

Nylon Fully Insulated Butted Seam – Male Disconnects

Terminal Type	Disconnect
Terminal Style	Fully Insulated
Fastener Orientation	Male
Insulation Material	Nylon
Barrel Style	Butted
RoHS 2011/65/EU	Yes
Agency Approval	 
Manufacturing Origin	



Order No.	UPC	Conductor Size	Mates with Male Tab Width (W')	Terminals per Bag
MTI18-187Q	051128-60025	22 - 18 AWG	0.187"	25
MTI18-250Q	051128-60026	22 - 18 AWG	0.250"	25
MTI14-187Q	051128-60023	16 - 14 AWG	0.187"	25
MTI14-250Q	051128-60024	16 - 14 AWG	0.250"	25
MTI10-250Q	051128-60022	12 - 10 AWG	0.250"	25

Vinyl Insulated Butted Seam – Male Disconnects

Terminal Type	Disconnect
Terminal Style	Standard
Fastener Orientation	Male
Insulation Material	Vinyl
Barrel Style	Butted
RoHS 2011/65/EU	Yes
Agency Approval	 
Manufacturing Origin	



Order No.	UPC	Conductor Size	Mates with Male Tab Width (W')	Terminals per Bag
MTV18-187Q	051128-60030	22 - 18 AWG	0.187"	25
MTV18-250Q	051128-60031	22 - 18 AWG	0.250"	25
MTV14-187Q	051128-60028	16 - 14 AWG	0.187"	25
MTV14-250Q	051128-60029	16 - 14 AWG	0.250"	25
MTV10-250Q	051128-60027	12 - 10 AWG	0.250"	25

Kits and Tools

3M™ Scotchlok™ Terminal Kit STK-1 (Filled)

The 3M™ Scotchlok™ Terminal Kit is filled with 3M's most frequently purchased low voltage termination products, including 14 of our most popular terminals.

The STK-1 kit is constructed of durable metal with individual product compartments. While the compartments keep you organized, the rugged metal frame protects the contents even in harsh environments. This kit contains: 1 3M™ Scotchlok™ Crimping Tool TH-440; 1 3M™ ScotchCode™ Tape Dispenser STD-0-9; 100 3M™ Cable Ties 06225; 100 3M™ Cable Ties 06226; 50 3M™ Highland™ Ring Tongue Terminal RV18-6; 50 3M™ Highland™ Ring Tongue Terminal RV18-8; 50 3M™ Highland™ Ring Tongue Terminal RV14-6; 50 3M™ Highland™ Ring Tongue Terminal RV14-8; 50 3M™ Highland™ Ring Tongue Terminal RV14-10; 25 3M™ Highland™ Ring Tongue Terminal RV10-10; 50 3M™ Highland™ Block Fork Terminal BFV14-8; 50 3M™ Highland™ Block Fork Terminal BFV14-10; 50 3M™ Highland™ Block Fork Terminal BFV18-8; 50 3M™ Highland™ Block Fork Terminal BFV18-6; 50 3M™ Highland™ Butt Connector BSV18; 50 3M™ Highland™ Butt Connector BSV14; 25 3M™ Highland™ Butt Connector BSV10; 50 3M™ Highland™ Female Disconnect FDV14-250





Order No.	UPC	Description	Color
STK-1	051138-25348	Overall box size is 13-3/4" L x 10" W x 2-1/2" H.	Red

3M™ Scotchlok™ Terminal Boxes (Empty)

Manufacturing Origin



	RED-TERMINAL-BOX	CLEAR-TERMINAL-BOX
		
UPC	054007-11900	051128-57758
Description	This metal case with plastic insert tray is divided into 14 terminal compartments, one tool compartment and two miscellaneous compartments. Order contents separately.	This plastic organizing box for terminals is divided into 13 compartments, including one sized to hold a crimping tool. Order contents separately.
Color	Red	Clear

3M™ Tools

Manufacturing Origin



	TH-440	TH-450	TR-482	TR-490
				
UPC	054007-30120	054007-49575	054007-11902	054007-70481
Product Name	3M™ Scissors, Style TH-440	3M™ Scissors, Style TH-450	3M™ Ratchet, Style TR-482	3M™ Ratchet, Style TR-490
Description	High carbon, heat-treated steel crimping tool that has a unique design that provides a high strength/weight ratio that crimps a broad range of 22-10 AWG terminals and connectors.	One of the most versatile heavy-duty tools 3M has offered. It is made of high-strength, heat-treated carbon steel.	This tool crimps the barrel and insulation grip simultaneously on 22–10 AWG insulated terminals and connectors. The 3M™ Ratchet Style TR-482 will crimp nylon or vinyl insulated, butted or brazed seam terminals and connectors.	This tool crimps the barrel and insulation grip independently on 22–10 AWG insulated and non-insulated terminals and connectors, nylon or vinyl insulated, butted or brazed seam.
Range	22-10 AWG	26-6 AWG	22-10 AWG	22-10 AWG



Index by Product Number

Product Number	Page	Product Number	Page	Product Number	Page
BFV10-10Q	74	M10-12RK	18	M14-6FX	26
BFV10-6Q	74	M10-14FLK	38	M14-6R/LK	18
BFV10-8Q	74	M10-14FLX	38	M14-6R/SK	18
BFV14-10Q	74	M10-14R/SK	18	M14-6R/SX	18
BFV14-6Q	74	M10-14R/SX	18	M14-8FBK	30
BFV14-8Q	74	M10-38R/SK	18	M14-8FBX	30
BFV18-10Q	74	M10-38R/SX	18	M14-8FLX	38
BFV18-6Q	74	M10-4R/SK	18	M14-8FX	26
BFV18-8Q	74	M10-516R/SX	18	M14-8R/LK	18
BSV10Q	75	M10-6FBK	30	M14-8R/LX	18
BSV14Q	75	M10-6FBX	30	M14BCK	43
BSV18Q	75	M10-6FK	26	M14BCX	43
CLEAR-TERMINAL-BOX	78	M10-6FX	26	M18-10FBK	30
FDI10-250Q	76	M10-6RK	18	M18-10FBX	30
FDI14-187Q	76	M10-6RX	18	M18-10FLX	38
FDI14-250Q	76	M10-8FBK	30	M18-10FX	26
FDI18-187Q	76	M10-8FBX	30	M18-10R/LK	18
FDI18-250Q	76	M10-8FK	26	M18-10R/LX	18
FDV10-250Q	76	M10-8FLX	38	M18-14R/SX	18
FDV14-187Q	76	M10-8FX	26	M18-38RX	18
FDV14-250Q	76	M10-8RK	18	M18-4R/SX	18
FDV18-187Q	76	M10-8RX	18	M18-6FB/SX	30
FDV18-250Q	76	M10BCK	43	M18-6FBX	30
FV10-10Q	73	M10BCX	43	M18-6FLK	38
FV10-8Q	73	M14-10FBX	30	M18-6FLX	38
FV14-10Q	73	M14-10FFBK	33	M18-6FX	26
FV14-6Q	73	M14-10FK	26	M18-6R/SK	18
FV14-8Q	73	M14-10FLK	38	M18-6R/SX	18
LFV10-10Q	75	M14-10FLX	38	M18-8FBK	30
LFV10-6Q	75	M14-10FX	26	M18-8FBX	30
LFV10-8Q	75	M14-10R/LK	18	M18-8FLX	38
LFV14-10Q	75	M14-10R/LX	18	M18-8FX	26
LFV14-6Q	75	M14-10RK	18	M18-8R/LK	18
LFV14-8Q	75	M14-14FLX	38	M18-8R/LX	18
LFV18-6Q	75	M14-14R/SK	18	M18BCK	43
LFV18-8Q	75	M14-14R/SX	18	M18BCX	43
M10-10FBK	30	M14-38RX	18	M4-10RX	19
M10-10FBX	30	M14-4R/SX	18	M4-12R/SK	19
M10-10FFBK	33	M14-516R/SK	18	M4-14RK	19
M10-10FK	26	M14-6FB/SK	30	M4-14RX	19
M10-10FLK	38	M14-6FB/SX	30	M4-38RK	19
M10-10FLX	38	M14-6FBK	30	M4-38RX	19
M10-10FX	26	M14-6FBX	30	M4-516RK	19
M10-10RK	18	M14-6FLK	38	M4-516RX	19
M10-10RX	18	M14-6FLX	38	M4BCK	44

Index by Product Number

Product Number	Page	Product Number	Page	Product Number	Page
M4BCX.....	44	MC3/0-12RX.....	22	MH18-10FLX.....	34
M6-10R/SK.....	19	MC3/0-38RX.....	22	MH18-10R/LK.....	12
M6-10R/SX.....	19	MC3/0BCX.....	44	MH18-10R/LX.....	12
M6-12R/SK.....	19	MC4/0-12RX.....	22	MH18-6FLK.....	34
M6-14R/SK.....	19	MC4/0-38RX.....	22	MH18-6FLX.....	34
M6-14R/SX.....	19	MC4/0BCX.....	44	MH18-6R/LK.....	12
M6-38RK.....	19	MH10-10FLK.....	35	MH18-6R/LX.....	12
M6-38RX.....	19	MH10-10FLX.....	35	MH18-8FLK.....	34
M6-516RK.....	19	MH10-10RK.....	12	MH18-8FLX.....	34
M6-516RX.....	19	MH10-10RX.....	12	MH18-8R/LK.....	12
M6BCK.....	44	MH10-14FLK.....	35	MH18-8R/LX.....	12
M6BCX.....	44	MH10-14FLX.....	35	MH18BCK.....	40
M8-10R/SK.....	19	MH10-14RK.....	12	MH18BCX.....	40
M8-10R/SX.....	18	MH10-14RX.....	12	MI10-250DFK.....	54
M8-12R/SK.....	19	MH10-38RK.....	12	MI10-250DFX.....	54
M8-14R/SK.....	19	MH10-38RX.....	12	MI18-250DFK.....	54
M8-14R/SX.....	19	MH10-8FLK.....	35	MN10BCK-A.....	40
M8-38RK.....	19	MH10-8FLX.....	35	MN10BCX.....	40
M8-38RX.....	19	MH10-8RK.....	12	MN10BCX-A.....	40
M8-516RK.....	19	MH10-8RX.....	12	MN14BCK-A.....	40
M8-516RX.....	19	MH10BCK.....	40	MN14BCX.....	40
M8BCK.....	44	MH10BCX.....	40	MN14BCX-A.....	40
M8BCX.....	44	MH14-10FLK.....	35	MN18BCK-A.....	40
MA250DMFMK-A.....	62	MH14-10FLX.....	34	MN18BCX.....	40
MA250DMFMX-A.....	62	MH14-10R/LK.....	12	MN18BCX-A.....	40
MA250DMMFK.....	62	MH14-10R/LX.....	12	MN24-2RK.....	15
MA250DMMFX.....	62	MH14-14FLK.....	35	MN24-4RK.....	15
MC1/0-12RX.....	22	MH14-14FLX.....	35	MN24-6RK.....	15
MC1/0-14RX.....	22	MH14-14R/SK.....	12	MN24-8RK.....	15
MC1/0-38RX.....	22	MH14-14R/SX.....	12	MN4-10RK.....	14
MC1/0BCX.....	44	MH14-38RK.....	12	MN4-12R/SK.....	14
MC1-14RX.....	22	MH14-38RX.....	12	MN4-14RK.....	14
MC1-38RX.....	22	MH14-516R/SK.....	12	MN4-38RK.....	14
MC1-516RX.....	22	MH14-516R/SX.....	12	MN4-38RX.....	14
MC1BCX.....	44	MH14-6FLK.....	34	MN4-516RK.....	14
MC2/0-12RX.....	22	MH14-6FLX.....	34	MN6-10R/SK.....	14
MC2/0-38RX.....	22	MH14-6R/LK.....	12	MN6-12R/SK.....	14
MC2/0BCX.....	44	MH14-6R/LX.....	12	MN6-14R/SK.....	14
MC2-14RX.....	22	MH14-8FLK.....	34	MN6-14R/SX.....	14
MC2-38RX.....	22	MH14-8FLX.....	34	MN6-38RK.....	14
MC250-12RX.....	22	MH14-8R/LK.....	12	MN6-38RX.....	14
MC250-38RX.....	22	MH14-8R/LX.....	12	MN6-516RK.....	14
MC250BCX.....	44	MH14BCK.....	40	MN8-10R/SK.....	14
MC2-516RX.....	22	MH14BCX.....	40	MN8-12R/SK.....	15
MC2BCX.....	44	MH18-10FLK.....	34	MN8-14R/SK.....	14

Index by Product Number

Product Number	Page	Product Number	Page	Product Number	Page
MN8-14R/SX.....	14	MNG10-8FLX.....	36	MNG14-250DMIX.....	56
MN8-38RK.....	15	MNG10-8FX.....	23	MNG14-250DMK.....	58
MN8-38RX.....	14	MNG10-8RK.....	14	MNG14-250DMX.....	58
MN8-516RK.....	14	MNG10-8RX.....	14	MNG14-38RK.....	13
MNG10-10FBK.....	27	MNG10BCK.....	41	MNG14-38RX.....	13
MNG10-10FBX.....	27	MNG10BCMKA.....	41	MNG14-47PK-A.....	67
MNG10-10FFBK.....	32	MNG10BCMXA.....	41	MNG14-47PX-A.....	67
MNG10-10FFBX.....	32	MNG10BCX.....	41	MNG14-4FB/SK.....	27
MNG10-10FK.....	23	MNG14-10FBK.....	27	MNG14-4FLX.....	35
MNG10-10FLK.....	36	MNG14-10FBX.....	27	MNG14-4R/SX.....	13
MNG10-10FLX.....	36	MNG14-10FFBK.....	32	MNG14-516R/SK.....	13
MNG10-10FX.....	23	MNG14-10FFBX.....	32	MNG14-516R/SX.....	13
MNG10-10RK.....	14	MNG14-10FK.....	23	MNG14-610RX.....	21
MNG10-10RX.....	14	MNG14-10FLK.....	35	MNG14-6FB/SK.....	27
MNG10-14FLK.....	36	MNG14-10FLX.....	35	MNG14-6FB/SX.....	27
MNG10-14FLX.....	36	MNG14-10FX.....	23	MNG14-6FBK.....	27
MNG10-14R/SK.....	14	MNG14-10R/LK.....	13	MNG14-6FBX.....	27
MNG10-14R/SX.....	14	MNG14-10R/LX.....	13	MNG14-6FFB/SX.....	32
MNG10-250DMIK.....	57	MNG14-10RK.....	13	MNG14-6FFBK.....	32
MNG10-250DMIX.....	57	MNG14-10RX.....	13	MNG14-6FLK.....	35
MNG10-250DMK.....	58	MNG14-110DFK-A.....	51	MNG14-6FLX.....	35
MNG10-250DMX.....	58	MNG14-14FLX.....	35	MNG14-6FX.....	23
MNG10-375DFK.....	51	MNG14-14R/SK.....	13	MNG14-6R/SK.....	13
MNG10-38R/SK.....	14	MNG14-14R/SX.....	13	MNG14-6R/SX.....	13
MNG10-38R/SX.....	14	MNG14-156DFIK-A.....	50	MNG14-8FBK.....	27
MNG10-4R/SK.....	13	MNG14-156DFIX-A.....	50	MNG14-8FBX.....	27
MNG10-516R/SK.....	14	MNG14-156DMKA.....	58	MNG14-8FFBK.....	32
MNG10-516R/SX.....	14	MNG14-156DMXA.....	58	MNG14-8FFBX.....	32
MNG10-55PK-A.....	67	MNG14-180DFIK-A.....	50	MNG14-8FK.....	23
MNG10-55PX-A.....	67	MNG14-180DFIX-A.....	50	MNG14-8FLK.....	35
MNG10-610RX.....	21	MNG14-187DFIK.....	48	MNG14-8FLX.....	35
MNG10-6FBK.....	27	MNG14-187DFIX.....	48	MNG14-8FX.....	23
MNG10-6FBX.....	27	MNG14-187DFK.....	51	MNG14-8R/LK.....	13
MNG10-6FFBX.....	32	MNG14-187DFX.....	51	MNG14-8R/LX.....	13
MNG10-6FLK.....	35	MNG14-187DMIK.....	56	MNG14-8R/SK.....	13
MNG10-6FLX.....	35	MNG14-187DMIX.....	56	MNG14-8R/SX.....	13
MNG10-6FX.....	23	MNG14-187DMK.....	58	MNG14-8RK.....	13
MNG10-6RK.....	13	MNG14-187DMX.....	58	MNG14-8RX.....	13
MNG10-6RX.....	14	MNG14-250DFIK.....	48	MNG14BCK.....	41
MNG10-8FBK.....	27	MNG14-250DFIX.....	48	MNG14BCMKA.....	41
MNG10-8FBX.....	27	MNG14-250DFK.....	51	MNG14BCMXA.....	41
MNG10-8FFBK.....	32	MNG14-250DFX.....	51	MNG14BCX.....	41
MNG10-8FFBX.....	32	MNG14-250DMFK-A.....	61	MNG18-10FBK.....	27
MNG10-8FK.....	23	MNG14-250DMFX-A.....	61	MNG18-10FBX.....	27
MNG10-8FLK.....	36	MNG14-250DMIK.....	57	MNG18-10FFBK.....	32

Index by Product Number

Product Number	Page	Product Number	Page	Product Number	Page
MNG18-10FFBX	32	MNG18-6FLX	35	MNI18-250DFIK	47
MNG18-10FLK	35	MNG18-6FX	23	MNI18-250DFIX	47
MNG18-10FLX	35	MNG18-6R/SK	13	MNU10-250DFIX	49
MNG18-10FX	23	MNG18-6R/SX	13	MNU10-250DMIK	57
MNG18-10R/LK	13	MNG18-8FBK	27	MNU10-250DMIX	57
MNG18-10R/LX	13	MNG18-8FBX	27	MNU14-187DFIK	49
MNG18-110DFK-A	51	MNG18-8FFBK	32	MNU14-187DFIX	49
MNG18-14R/SK	13	MNG18-8FFBX	32	MNU14-187DMIK	57
MNG18-14R/SX	13	MNG18-8FLK	35	MNU14-187DMIX	57
MNG18-156DFIK-A	50	MNG18-8FLX	35	MNU14-250DFIK	49
MNG18-156DMK-A	58	MNG18-8FX	23	MNU14-250DFIX	49
MNG18-180DFIK-A	50	MNG18-8R/LK	13	MNU14-250DMIK	57
MNG18-180DMK-A	58	MNG18-8R/LX	13	MNU14-250DMIX	57
MNG18-187DFIK	48	MNG18BCK	41	MNU18-187DFIK	49
MNG18-187DFIX	48	MNG18BCMKA	41	MNU18-187DFIX	49
MNG18-187DFK	51	MNG18BCMXA	41	MNU18-187DMIK	57
MNG18-187DMIK	56	MNG18BCX	41	MNU18-187DMIX	57
MNG18-187DMIX	56	MNGI10-250DFIK	46	MNU18-250DFIK	49
MNG18-187DMK	58	MNGI10-250DFIX	46	MNU18-250DFIX	49
MNG18-250DFIK	48	MNGI10-250DFK	50	MNU18-250DMIK	57
MNG18-250DFIX	48	MNGI10-250DFX	50	MNU18-250DMIX	57
MNG18-250DFK	51	MNGI14-250DFIK	46	MTI10-250Q	77
MNG18-250DFX	51	MNGI14-250DFIX	46	MTI14-187Q	77
MNG18-250DMFX-A	61	MNGI14-250DFK	50	MTI14-250Q	77
MNG18-250DMIK	56	MNGI14-250DFX	50	MTI18-187Q	77
MNG18-250DMIX	56	MNGI18-250DFIK	46	MTI18-250Q	77
MNG18-250DMK	58	MNGI18-250DFIX	46	MTV10-250Q	77
MNG18-250DMX	58	MNGI18-250DFK	50	MTV14-187Q	77
MNG18-38RK	13	MNGI18-250DFX	50	MTV14-250Q	77
MNG18-38RX	13	MNHU10-250DFIK	45	MTV18-187Q	77
MNG18-47PX-A	67	MNHU10-250DFIX	45	MTV18-250Q	77
MNG18-4FB/SK	27	MNHU10-250DMIK	56	MU10-10FBK	31
MNG18-4FLK	35	MNHU10-250DMIX	56	MU10-10FHTK	64
MNG18-4FLX	35	MNHU14-250DFIK	45	MU10-10FK	26
MNG18-4R/SK	13	MNHU14-250DFIX	45	MU10-10FLK	39
MNG18-4R/SX	13	MNHU14-250DMIK	56	MU10-10FLX	39
MNG18-516R/SX	13	MNHU14-250DMIX	56	MU10-10RHTK	63
MNG18-610RX	21	MNHU18-250DFIK	45	MU10-10RHTX	63
MNG18-6FB/SK	27	MNHU18-250DFIX	45	MU10-10RK	20
MNG18-6FB/SX	27	MNHU18-250DMIK	56	MU10-14FLK	39
MNG18-6FBK	27	MNHU18-250DMIX	56	MU10-14FLX	39
MNG18-6FBX	27	MNI10-250DFIK	47	MU10-14R/SK	20
MNG18-6FFB/SX	32	MNI10-250DFIX	47	MU10-14RHTK	63
MNG18-6FFBK	32	MNI14-250DFIK	47	MU10-250DMK	60
MNG18-6FLK	35	MNI14-250DFIX	47	MU10-250DMX	60

Index by Product Number

Product Number	Page	Product Number	Page	Product Number	Page
MU10-4R/SK.....	20	MU14-250DMHTX	66	MU18-47PX-A.....	68
MU10-55PX-A.....	68	MU14-250DMK.....	60	MU18-4FB/SK.....	31
MU10-6FBK.....	31	MU14-250DMX.....	60	MU18-4FLK.....	39
MU10-6RK.....	20	MU14-47PK-A.....	68	MU18-4R/SK.....	20
MU10-6RX.....	20	MU14-47PX-A.....	68	MU18-6FB/SK.....	31
MU10-8FBK.....	31	MU14-4FB/SK.....	31	MU18-6FBHTK.....	64
MU10-8FFBK.....	34	MU14-4R/SK.....	20	MU18-6FBK.....	31
MU10-8FLK.....	39	MU14-6FB/SK.....	31	MU18-6FFBK.....	34
MU10-8FLX.....	39	MU14-6FBHTK.....	64	MU18-6FK.....	26
MU10-8RK.....	20	MU14-6FLK.....	39	MU18-6FLK.....	39
MU10-8RX.....	20	MU14-6FLX.....	39	MU18-6FLX.....	39
MU10BCHTK.....	65	MU14-6R/SK.....	20	MU18-6R/SK.....	20
MU10BCHTX.....	65	MU14-6RHT/SK.....	63	MU18-6RHT/SX.....	63
MU10BCX.....	45	MU14-6RHT/SX.....	63	MU18-8FBK.....	31
MU14-10FBK.....	31	MU14-8FBK.....	31	MU18-8FLK.....	39
MU14-10FHTK.....	64	MU14-8FFBK.....	34	MU18-8FLX.....	39
MU14-10FK.....	26	MU14-8FLK.....	39	MU18-8R/LK.....	20
MU14-10FLK.....	39	MU14-8FLX.....	39	MU18-8RLX.....	20
MU14-10FLX.....	39	MU14-8R/LK.....	20	MU18BCHTK.....	65
MU14-10R/LK.....	20	MU14-8RLX.....	20	MU18BCHTX.....	65
MU14-10RHTK.....	63	MU14BCHTK.....	65	MU18BCX.....	45
MU14-10RHTX.....	63	MU14BCHTX.....	65	MU20-110/32DFK-A.....	54
MU14-10RK.....	20	MU14BCX.....	45	MU4-38RHTK.....	63
MU14-10RX.....	20	MU18-10FBK.....	31	MU6-38RHTK.....	63
MU14-110DFK.....	54	MU18-10FHTK.....	64	MU8-14RHT/SK.....	63
MU14-110DFX.....	54	MU18-10FLK.....	39	MV10-10FBK.....	28
MU14-14FLK.....	39	MU18-10FLX.....	39	MV10-10FBX.....	28
MU14-14R/SK.....	20	MU18-10R/LK.....	20	MV10-10FK.....	24
MU14-14RHTK.....	63	MU18-10RHTK.....	63	MV10-10FLK.....	36
MU14-14RHTX.....	63	MU18-10RHTX.....	63	MV10-10FLX.....	36
MU14-187DF/FLAGK.....	55	MU18-10RX.....	20	MV10-10FX.....	24
MU14-187DF/FLAGX.....	55	MU18-14R/SK.....	20	MV10-10RK.....	16
MU14-187DFHTK.....	65	MU18-187DF/FLAGK.....	55	MV10-10RX.....	16
MU14-187DFK.....	54	MU18-187DF/FLAGX.....	55	MV10-12RK.....	16
MU14-187DFX.....	55	MU18-187DFK.....	54	MV10-12RX.....	16
MU14-187DMK.....	60	MU18-187DFX.....	54	MV10-14FLK.....	36
MU14-187DMX.....	60	MU18-187DMK.....	60	MV10-14FLX.....	36
MU14-250DF/FLAGK.....	55	MU18-187DMX.....	60	MV10-14R/SK.....	16
MU14-250DF/FLAGX.....	55	MU18-250DF/FLAGK.....	55	MV10-14R/SX.....	16
MU14-250DFHT/FLAGK.....	66	MU18-250DF/FLAGX.....	55	MV10-38R/SK.....	16
MU14-250DFHTK.....	65	MU18-250DFK.....	54	MV10-38R/SX.....	16
MU14-250DFHTX.....	65	MU18-250DFX.....	54	MV10-4R/SK.....	16
MU14-250DFK.....	55	MU18-250DMK.....	60	MV10-516R/SK.....	16
MU14-250DFX.....	55	MU18-250DMX.....	60	MV10-516R/SX.....	16
MU14-250DMHTK.....	66	MU18-38RK.....	20	MV10-610RK.....	21

Index by Product Number

Product Number	Page	Product Number	Page	Product Number	Page
MV10-610RX.....	21	MV14-6FLK.....	36	MV18-8FK.....	24
MV10-6FBK.....	28	MV14-6FLX.....	36	MV18-8FLK.....	36
MV10-6FBX.....	28	MV14-6FX.....	24	MV18-8FLX.....	36
MV10-6FLK.....	36	MV14-6R/SK.....	15	MV18-8FX.....	24
MV10-6FLX.....	36	MV14-6R/SX.....	15	MV18-8R/LK.....	15
MV10-6FX.....	24	MV14-8FBK.....	28	MV18-8R/LX.....	15
MV10-6RK.....	16	MV14-8FBX.....	28	MV18BCK.....	42
MV10-6RX.....	16	MV14-8FK.....	24	MV18BCX.....	42
MV10-8FBK.....	28	MV14-8FLK.....	36	MV4BCK.....	42
MV10-8FBX.....	28	MV14-8FLX.....	36	MV4BCX.....	42
MV10-8FK.....	24	MV14-8FX.....	24	MV6BCK.....	42
MV10-8FLK.....	36	MV14-8R/LK.....	15	MV6BCX.....	42
MV10-8FLX.....	36	MV14-8R/LX.....	15	MV8BCK.....	42
MV10-8FX.....	24	MV14-8R/SK.....	15	MV8BCX.....	42
MV10-8RK.....	16	MV14BCK.....	42	MVG24-110/32DFX.....	52
MV10-8RX.....	16	MV14BCX.....	42	MVG24-110DFK.....	52
MV10BCK.....	42	MV18-10FBK.....	28	MVI10-250DFK.....	52
MV10BCX.....	42	MV18-10FBX.....	28	MVI10-250DFX.....	52
MV14-10FBK.....	28	MV18-10FLK.....	36	MVI14-250DFK.....	52
MV14-10FBX.....	28	MV18-10FLX.....	36	MVI14-250DFX.....	52
MV14-10FK.....	24	MV18-10FX.....	24	MVI18-250DFK.....	52
MV14-10FLK.....	36	MV18-10R/LK.....	15	MVI18-250DFX.....	52
MV14-10FLX.....	36	MV18-10R/LX.....	15	MVU10-10FBK.....	29
MV14-10FX.....	24	MV18-14R/SK.....	15	MVU10-10FBX.....	29
MV14-10R/LK.....	15	MV18-14R/SX.....	15	MVU10-10FFBK.....	33
MV14-10R/LX.....	15	MV18-38RX.....	15	MVU10-10FK.....	25
MV14-10RK.....	15	MV18-4FLK.....	36	MVU10-10FLK.....	37
MV14-14FLX.....	36	MV18-4FLX.....	36	MVU10-10FX.....	25
MV14-14R/SK.....	15	MV18-4R/SK.....	15	MVU10-10RK.....	17
MV14-14R/SX.....	15	MV18-4R/SX.....	15	MVU10-10RX.....	17
MV14-38RK.....	16	MV18-516R/SX.....	15	MVU10-14FLK.....	37
MV14-38RX.....	16	MV18-610RK.....	21	MVU10-14R/SK.....	17
MV14-4FB/SK.....	28	MV18-610RX.....	21	MVU10-14R/SX.....	17
MV14-4FLX.....	36	MV18-6FB/SK.....	28	MVU10-250DMK.....	59
MV14-4R/SK.....	15	MV18-6FB/SX.....	28	MVU10-250DMX.....	59
MV14-4R/SX.....	15	MV18-6FBK.....	28	MVU10-375DFK.....	53
MV14-516R/SK.....	16	MV18-6FBX.....	28	MVU10-38R/SK.....	17
MV14-516R/SX.....	15	MV18-6FK.....	24	MVU10-38R/SX.....	17
MV14-610RK.....	21	MV18-6FLK.....	36	MVU10-38RX.....	17
MV14-610RX.....	21	MV18-6FLX.....	36	MVU10-4R/SK.....	17
MV14-6FB/SK.....	28	MV18-6FX.....	24	MVU10-516R/SK.....	17
MV14-6FB/SX.....	28	MV18-6R/SK.....	15	MVU10-55PK-A.....	67
MV14-6FBK.....	28	MV18-6R/SX.....	15	MVU10-55PX-A.....	67
MV14-6FBX.....	28	MV18-8FBK.....	28	MVU10-6FBK.....	29
MV14-6FK.....	24	MV18-8FBX.....	28	MVU10-6FBX.....	29

Index by Product Number

Product Number	Page	Product Number	Page	Product Number	Page
MVU10-6FFBK	33	MVU14-38R/SX	17	MVU18-187DFK	53
MVU10-6FK	25	MVU14-38RK	17	MVU18-187DFX	53
MVU10-6FLK	37	MVU14-47PK-A	67	MVU18-187DMK	59
MVU10-6FX	25	MVU14-47PX-A	67	MVU18-187DMX	59
MVU10-6RK	17	MVU14-4FB/SK	29	MVU18-250DFK	53
MVU10-6RX	17	MVU14-4FLK	37	MVU18-250DFX	53
MVU10-8FBK	29	MVU14-4R/SK	17	MVU18-250DMFK-A	61
MVU10-8FBX	29	MVU14-516R/SK	17	MVU18-250DMFX-A	61
MVU10-8FFBK	33	MVU14-6FB/SK	29	MVU18-250DMK	59
MVU10-8FK	25	MVU14-6FB/SX	29	MVU18-250DMX	59
MVU10-8FLK	37	MVU14-6FBK	29	MVU18-38RK	16
MVU10-8FX	25	MVU14-6FBX	29	MVU18-47PK-A	67
MVU10-8R/SX	17	MVU14-6FFBK	33	MVU18-47PX-A	67
MVU10-8RK	17	MVU14-6FK	25	MVU18-4FB/SK	29
MVU10-8RX	17	MVU14-6FLK	37	MVU18-4FLK	37
MVU10BCK	43	MVU14-6FX	25	MVU18-4R/SK	16
MVU10BCX	43	MVU14-6R/SK	17	MVU18-516R/SK	16
MVU10PCK	70	MVU14-6R/SX	17	MVU18-6FB/SK	29
MVU14-10FBK	29	MVU14-8FBK	29	MVU18-6FBK	29
MVU14-10FBX	29	MVU14-8FBX	29	MVU18-6FBX	29
MVU14-10FFBK	33	MVU14-8FFBK	33	MVU18-6FFBK	33
MVU14-10FK	25	MVU14-8FK	25	MVU18-6FK	25
MVU14-10FLK	37	MVU14-8FLK	37	MVU18-6FLK	37
MVU14-10FX	25	MVU14-8FX	25	MVU18-6FX	25
MVU14-10R/LK	17	MVU14-8R/LK	17	MVU18-6R/SK	16
MVU14-10RK	17	MVU14-8R/SK	17	MVU18-6R/SX	16
MVU14-10RX	17	MVU14-8R/SX	17	MVU18-8FBK	29
MVU14-110DFK-A	53	MVU14-8RK	17	MVU18-8FBX	29
MVU14-14FLK	37	MVU14-8RX	17	MVU18-8FFBK	33
MVU14-14R/SK	17	MVU14BCK	43	MVU18-8FK	25
MVU14-14R/SX	17	MVU14BCX	43	MVU18-8FLK	37
MVU14-156DMK-A	59	MVU14PCK	70	MVU18-8FX	25
MVU14-156DMX-A	59	MVU18-10FBK	29	MVU18-8R/LK	16
MVU14-180DMK-A	59	MVU18-10FBX	29	MVU18-8R/LX	16
MVU14-180DMX-A	59	MVU18-10FFBK	33	MVU18-8R/SX	16
MVU14-187DFK	53	MVU18-10FK	25	MVU18BCK	43
MVU14-187DFX	53	MVU18-10FLK	37	MVU18BCX	43
MVU14-187DMK	59	MVU18-10FX	25	MVU18PCK	70
MVU14-187DMX	59	MVU18-10R/LK	16	RED-TERMINAL-BOX	78
MVU14-250DFK	53	MVU18-10R/LX	16	RV10-10Q	72
MVU14-250DFX	53	MVU18-10RX	16	RV10-14Q	72
MVU14-250DMFK-A	61	MVU18-14R/SK	16	RV10-38Q	72
MVU14-250DMFX-A	61	MVU18-14R/SX	16	RV10-516Q	72
MVU14-250DMK	59	MVU18-156DMK-A	59	RV10-6Q	72
MVU14-250DMX	59	MVU18-180DMK-A	59	RV10-8Q	72

Index by Product Number

Product Number	Page
RV14-10Q.....	72
RV14-14Q.....	72
RV14-516Q.....	72
RV14-6Q.....	72
RV14-8Q.....	72
RV18-10Q.....	72
RV18-14Q.....	72
RV18-6Q.....	72
RV18-8Q.....	72
STK-1.....	78
TH-440.....	79
TH-450.....	79
TR-482.....	79
TR-490.....	79

3M, Scotchlok, Highland and Scotchcode are trademarks of 3M Company.

The images, pictures, and illustrations found in this catalog are for illustration purposes only. Check the Product Technical Data Sheets for actual product details.

3M products listed in this publication that are associated with a U.S.A. flag are manufactured in the USA as of the date of publication. 3M products offered on a government contract that require country of origin representation must be certified by 3M's Trade Compliance Department (contact your customer service support team to request a certification).

"RoHS 2011/65/EU" means that the product or part does not contain any of the substances in excess of the maximum concentration values ("MCVs") in EU RoHS Directive 2011/65/EU. The MCVs are by weight in homogeneous materials. This information represents 3M's knowledge and belief, which may be based in whole or in part on information provided by third party suppliers to 3M.

Important Notice

Before using this product, you must evaluate it and determine if it is suitable for your intended application. You assume all risks and liability associated with such use.

Warranty; Limited Remedy; Limited Liability.

3M's product warranty is stated in its Product Literature available upon request. **3M MAKES NO OTHER WARRANTIES INCLUDING, BUT NOT LIMITED TO, ANY IMPLIED WARRANTY OF MERCHANTABILITY OR FITNESS FOR A PARTICULAR PURPOSE.** If this product is defective within the warranty period stated above, your exclusive remedy shall be, at 3M's option, to replace or repair the 3M product or refund the purchase price of the 3M product. **Except where prohibited by law, 3M will not be liable for any indirect, special, incidental or consequential loss or damage arising from this 3M product, regardless of the legal theory asserted.**

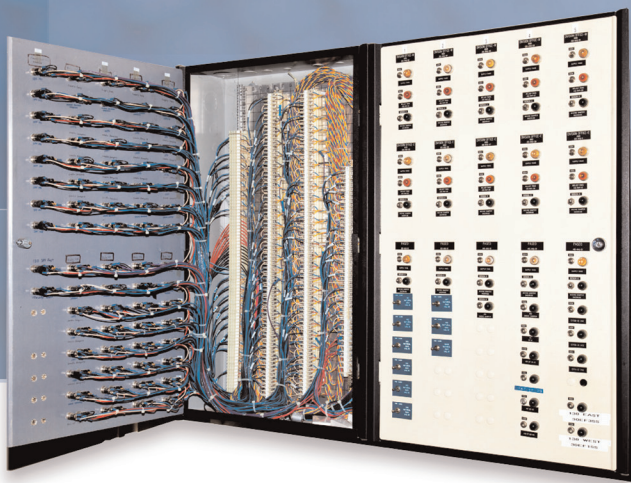

Electrical Markets Division

6801 River Place Blvd.
Austin, TX 78726-9000
800/245 3573
Fax 800/245 0329
www.3M.com/electrical

Please recycle. Printed in USA.
© 3M 2013. All rights reserved.
80-6016-0536-5 (08115.0) GP-2



Компания «ЭлектроПласт» предлагает заключение долгосрочных отношений при поставках импортных электронных компонентов на взаимовыгодных условиях!

Наши преимущества:

- Оперативные поставки широкого спектра электронных компонентов отечественного и импортного производства напрямую от производителей и с крупнейших мировых складов;
- Поставка более 17-ти миллионов наименований электронных компонентов;
- Поставка сложных, дефицитных, либо снятых с производства позиций;
- Оперативные сроки поставки под заказ (от 5 рабочих дней);
- Экспресс доставка в любую точку России;
- Техническая поддержка проекта, помощь в подборе аналогов, поставка прототипов;
- Система менеджмента качества сертифицирована по Международному стандарту ISO 9001;
- Лицензия ФСБ на осуществление работ с использованием сведений, составляющих государственную тайну;
- Поставка специализированных компонентов (Xilinx, Altera, Analog Devices, Intersil, Interpoint, Microsemi, Aeroflex, Peregrine, Syfer, Eurofarad, Texas Instrument, Miteq, Cobham, E2V, MA-COM, Hittite, Mini-Circuits, General Dynamics и др.);

Помимо этого, одним из направлений компании «ЭлектроПласт» является направление «Источники питания». Мы предлагаем Вам помощь Конструкторского отдела:

- Подбор оптимального решения, техническое обоснование при выборе компонента;
- Подбор аналогов;
- Консультации по применению компонента;
- Поставка образцов и прототипов;
- Техническая поддержка проекта;
- Защита от снятия компонента с производства.



Как с нами связаться

Телефон: 8 (812) 309 58 32 (многоканальный)

Факс: 8 (812) 320-02-42

Электронная почта: org@eplast1.ru

Адрес: 198099, г. Санкт-Петербург, ул. Калинина, дом 2, корпус 4, литера А.