

MAX6072

High-Precision, Dual-Output Series Voltage Reference

General Description

The MAX6072 is a dual-output precision series voltage reference. The product features two outputs, $+V_{REF}$ and $+V_{REF}/2$. The device exhibits a very low $1/f$ noise of 2ppm (peak-to-peak). Each output can source and sink 10mA and has an independent sense line. This product has a temperature drift of 6ppm/ $^{\circ}$ C (max) over the ambient temperature range of -40° C to $+125^{\circ}$ C and an initial accuracy of 0.04%. Three pairs of output voltages are available: 5V/2.5V, 4.096V/2.048V, and 2.5V/1.25V. The product operates with an input voltage range of 2.8V to 5.5V and has sufficient headroom for the highest voltage. It consumes a mere 150 μ A (typ) of quiescent supply current per reference. The dual voltage outputs make this device ideal for precision ADC applications where the input signal needs to be referred to $V_{REF}/2$.

The MAX6072 is available in a 10-pin μ MAX[®] package and is specified for operation over the extended -40° C to $+125^{\circ}$ C industrial temperature range.

Applications

- ADC/DAC References and Common-Mode Set-Point
- Test and Measurement/ATE
- High-Accuracy Industrial and Process Control
- Portable Medical

Benefits and Features

- Low Temperature Coefficient Ensures Stable System Over Wide Temperature Ranges
 - A-grade: 6ppm/ $^{\circ}$ C (max)
 - B-grade: 8ppm/ $^{\circ}$ C (max)
- Excellent Long-Term Drift Ensures Accurate Signal Chain Readings Over Time
 - 15ppm Drift Over 1,000 Hours
- Dual References (V_{REF} and $V_{REF}/2$) Provide ADC/DAC Reference and Common-Mode Reference
 - MAX6072__50: $V_{REF} = 5V$, $V_{REF}/2 = 2.5V$
 - MAX6072__41: $V_{REF} = 4.096V$, $V_{REF}/2 = 2.048V$
 - MAX6072__25: $V_{REF} = 2.5V$, $V_{REF}/2 = 1.25V$
- Low Thermal Hysteresis Ensures Consistent Results Through Temperature Cycles
 - 85ppm
 - 2.5ppm Thermal Hysteresis Tracking
- Separate Enable-Control for Each Output Allows Independent Control
- Low Power for Battery-/Loop-Powered Sensors: 150 μ A/Reference

Typical Operating Circuit and Ordering Information appears at end of data sheet.

For related parts and recommended products to use with this part, refer to www.maximintegrated.com/MAX6072.related.

Dual Reference Selector Guide

PART	OUTPUT VOLTAGES (V)	ACCURACY (%)	TEMPERATURE COEFFICIENT (ppm/ $^{\circ}$ C)
MAX6072AAUB50	5/2.5	0.05	6
MAX6072BAUB50	5/2.5	0.08	8
MAX6072AAUB41	4.096/2.048	0.05	6
MAX6072BAUB41	4.096/2.048	0.08	8
MAX6072AAUB25	2.5/1.25	0.05	6
MAX6072BAUB25	2.5/1.25	0.08	8

μ MAX is a registered trademark of Maxim Integrated Products, Inc.



Absolute Maximum Ratings

IN1, IN2 to GND	-0.3V to +6V	Operating Temperature Range	-40°C to +125°C
OUT1F to GND	-0.3V to the lower of (V _{IN1} + 0.3V), +6V	Storage Temperature	-65°C to +150°C
OUT2F to GND	-0.3V to the lower of (V _{IN2} + 0.3V), +6V	Junction Temperature	+150°C
OUT1S, OUT2S to GND	-0.3V to +6V	Lead Temperature (soldering, 10s)	+300°C
EN1, EN2 to GND	-0.3V to +6V	Soldering Temperature	+260°C
Continuous Power Dissipation (T _A = +70°C)			
μMAX (derate 5.6mW/°C above +70°C)	444mW		

Stresses beyond those listed under "Absolute Maximum Ratings" may cause permanent damage to the device. These are stress ratings only, and functional operation of the device at these or any other conditions beyond those indicated in the operational sections of the specifications is not implied. Exposure to absolute maximum rating conditions for extended periods may affect device reliability.

Package Thermal Characteristics (Note 1)

μMAX			
Junction-to-Ambient Thermal Resistance (θ _{JA})	180°C/W	Junction-to-Case Thermal Resistance (θ _{JC})	42°C/W

Note 1: Package thermal resistances were obtained using the method described in JEDEC specification JESD51-7, using a four-layer board. For detailed information on package thermal considerations, refer to www.maximintegrated.com/thermal-tutorial.

MAX6072_50 Electrical Characteristics (V_{REF1}: V_{OUT1F} = 5V, V_{REF2}: V_{OUT2F} = 2.5V)

(V_{IN1} = V_{EN1} = V_{IN2} = V_{EN2} = +5.5V, I_{OUT} = 0mA, C_{OUT} = 0.1μF, T_A = -40°C to +125°C, unless otherwise noted. Typical values are at T_A = +25°C.) (Note 2)

PARAMETER	SYMBOL	CONDITIONS	MIN	TYP	MAX	UNITS
OUTPUT						
Output Voltage Accuracy (OUT1F and OUT2F)		MAX6072A_50, T _A = +25°C	-0.05		+0.05	%
		MAX6072B_50, T _A = +25°C	-0.08		+0.08	
Output Voltage Temperature Drift (OUT1F and OUT2F) (Note 3)	TCV _{OUT}	MAX6072A_50		1.5	6	ppm/°C
		MAX6072B_50		2.0	8	
Output Voltage Temperature Drift Tracking (OUT1F and OUT2F) (Note 3)	ΔTC	MAX6072A_50		0.4		ppm/°C
		MAX6072B_50		0.4		
Line Regulation		OUT1F, 5.2V < V _{IN1} < 5.5V	T _A = +25°C	200	620	μV/V
			T _A = -40°C to +125°C		700	
		OUT2F, 2.8V < V _{IN2} < 5.5V	T _A = +25°C	60	260	
			T _A = -40°C to +125°C		275	
Load Regulation		0mA < I _{OUT} < 10mA, sink	OUT1F	160	290	μV/mA
				0mA < I _{OUT} < 10mA, source	160	
		0mA < I _{OUT} < 10mA, sink	OUT2F	80	185	
				0mA < I _{OUT} < 10mA, source	75	

**MAX6072_50 Electrical Characteristics (V_{REF1}: V_{OUT1F} = 5V, V_{REF2}: V_{OUT2F} = 2.5V)
(continued)**

(V_{IN1} = V_{EN1} = V_{IN2} = V_{EN2} = +5.5V, I_{OUT} = 0mA, C_{OUT} = 0.1μF, T_A = -40°C to +125°C, unless otherwise noted. Typical values are at T_A = +25°C.) (Note 2)

PARAMETER	SYMBOL	CONDITIONS		MIN	TYP	MAX	UNITS
Dropout Voltage		I _{OUT} = 10mA, T _A = -40°C to +125°C	OUT1F (Note 6)	60	150		mV
			OUT2F (Note 4)	110	230		
Output Current (OUT1F and OUT2F)	I _{OUT}			-10		+10	mA
Short-Circuit Current (OUT1F and OUT2F)	I _{SC}	Sourcing to ground			25		mA
		Sinking from V _{IN}			25		
Thermal Hysteresis (Note 5)		OUT1F			85		ppm
		OUT2F			85		
Thermal Hysteresis Tracking (Note 5)		OUT2F to OUT1F			2.5		ppm
Long-Term Stability		OUT1F, 1000 hours at T _A = +25°C			15		ppm
		OUT2F, 1000 hours at T _A = +25°C			15		
Long-Term Drift Tracking					5		ppm
DYNAMIC CHARACTERISTICS							
Noise Voltage	e _{OUT}	1/f noise, 0.1Hz to 10Hz, C _{OUT} = 0.1μF	OUT1F		9		μV _{P-P}
			OUT2F		4.8		
		Thermal noise, 10Hz to 10kHz, C _{OUT} = 0.1μF	OUT1F		15		μV _{RMS}
			OUT2F		6		
Noise Voltage Spectral Density		Thermal noise, f= 1kHz, C _{OUT} = 0.1μF	OUT1F		120		nV/√Hz
			OUT2F		60		
Ripple Rejection		Frequency = 60Hz	OUT1F		74		dB
			OUT2F		84		
Turn- On Settling Time	t _R	Settling to 0.01%, C _{OUT} = 0.1μF	OUT1F		50		μs
			OUT2F		30		
Enable Settling Time	t _{EN}	Settling to 0.01%, C _{OUT} = 0.1μF	OUT1F		100		μs
			OUT2F		75		

**MAX6072_50 Electrical Characteristics (V_{REF1}: V_{OUT1F} = 5V, V_{REF2}: V_{OUT2F} = 2.5V)
(continued)**

(V_{IN1} = V_{EN1} = V_{IN2} = V_{EN2} = +5.5V, I_{OUT} = 0mA, C_{OUT} = 0.1μF, T_A = -40°C to +125°C, unless otherwise noted. Typical values are at T_A = +25°C.) (Note 2)

PARAMETER	SYMBOL	CONDITIONS	MIN	TYP	MAX	UNITS
Capacitive-Load Stability Range (OUT1F, OUT2F)		I _{OUT} ≤ 10mA	0.1		10	μF
INPUT (IN1 and IN2)						
Supply Voltage	V _{IN}	Guaranteed by line regulation	OUT1F	5.2	5.5	V
			OUT2F	2.8	5.5	
REF1 Quiescent Supply Current	I _{IN}	T _A = +25°C		160	270	μA
		T _A = -40°C to +125°C			350	
REF2 Quiescent Supply Current	I _{IN}	T _A = +25°C		150	245	μA
		T _A = -40°C to +125°C			320	
Shutdown Supply Current per Reference	I _{SD}	V _{EN} = 0V		0.85	28	μA
ENABLE (EN1 and EN2)						
Enable Input Current	I _{EN}		-1		+1	μA
Enable Logic- High	V _{IH}		0.7 x V _{IN}			V
Enable Logic- Low	V _{IL}				0.3 x V _{IN}	V

MAX6072_41 Electrical Characteristics (V_{REF1}: V_{OUT1F} = 4.096V, V_{REF2}: V_{OUT2F} = 2.048V)

(V_{IN1} = V_{EN1} = V_{IN2} = V_{EN2} = +5V, I_{OUT} = 0mA, C_{OUT} = 0.1μF, T_A = -40°C to +125°C, unless otherwise noted. Typical values are at T_A = +25°C.) (Note 2)

PARAMETER	SYMBOL	CONDITIONS	MIN	TYP	MAX	UNITS	
OUTPUT							
Output Voltage Accuracy (OUT1F and OUT2F)		MAX6072A_41, T _A = +25°C	-0.05		+0.05	%	
		MAX6072B_41, T _A = +25°C	-0.08		+0.08		
Output Voltage Temperature Drift (OUT1F and OUT2F) (Note 3)	TCV _{OUT}	MAX6072A_41		1.5	6	ppm/°C	
		MAX6072B_41		2.0	8		
Output Voltage Temperature Drift Tracking (OUT1F and OUT2F) (Note 3)	ΔTC	MAX6072A_41		0.4		ppm/°C	
		MAX6072B_41		0.4			
Line Regulation		OUT1F, 4.3V < V _{IN1} < 5.5V	T _A = +25°C		100	450	μV/V
			T _A = -40°C to +125°C			485	
		OUT2F, 2.7V < V _{IN2} < 5.5V	T _A = +25°C		50	250	
			T _A = -40°C to +125°C			270	

MAX6072_41 Electrical Characteristics (V_{REF1}: V_{OUT1F} = 4.096V, V_{REF2}: V_{OUT2F} = 2.048V) (continued)

(V_{IN1} = V_{EN1} = V_{IN2} = V_{EN2} = +5V, I_{OUT} = 0mA, C_{OUT} = 0.1μF, T_A = -40°C to +125°C, unless otherwise noted. Typical values are at T_A = +25°C.) (Note 2)

PARAMETER	SYMBOL	CONDITIONS		MIN	TYP	MAX	UNITS
Load Regulation		0mA < I _{OUT} < 10mA, sink	OUT1F		125	260	μV/mA
		0mA < I _{OUT} < 10mA, source			135	300	
		0mA < I _{OUT} < 10mA, sink	OUT2F		135	260	
		0mA < I _{OUT} < 10mA, source			135	250	
Dropout Voltage		I _{OUT} = 10mA, T _A = -40°C to +125°C (Note 6)	OUT1F		75	150	mV
Output Current (OUT1F and OUT2F)	I _{OUT}			-10		+10	mA
Short-Circuit Current (OUT1F and OUT2F)	I _{SC}	Sourcing to ground			25		mA
		Sinking from V _{IN}			25		
Thermal Hysteresis (Note 5)		OUT1F			85		ppm
		OUT2F			85		
Thermal Hysteresis Tracking (Note 5)		OUT2F to OUT1F			2.5		ppm
Long-Term Stability		OUT1F, 1000 hours at T _A = +25°C			15		ppm
		OUT2F, 1000 hours at T _A = +25°C			15		
Long-Term Drift Matching					5		ppm
DYNAMIC CHARACTERISTICS							
Noise Voltage	e _{OUT}	1/f noise, 0.1Hz to 10Hz, C _{OUT} = 0.1μF	OUT1F		9.6		μV _{P-P}
			OUT2F		6.4		
		Thermal noise, 10Hz to 10kHz, C _{OUT} = 0.1μF	OUT1F		12		μV _{RMS}
			OUT2F		8.6		

MAX6072_41 Electrical Characteristics (V_{REF1}: V_{OUT1F} = 4.096V, V_{REF2}: V_{OUT2F} = 2.048V) (continued)

(V_{IN1} = V_{EN1} = V_{IN2} = V_{EN2} = +5V, I_{OUT} = 0mA, C_{OUT} = 0.1μF, T_A = -40°C to +125°C, unless otherwise noted. Typical values are at T_A = +25°C.) (Note 2)

PARAMETER	SYMBOL	CONDITIONS	MIN	TYP	MAX	UNITS
Noise Voltage Spectral Density		Thermal noise, f= 1kHz, C _{OUT} = 0.1μF	OUT1F	110		nV/√Hz
			OUT2F	75		
Ripple Rejection		Frequency = 60Hz	OUT1F	80		dB
			OUT2F	86		
Turn- On Settling Time	t _R	Settling to 0.01%, C _{OUT} = 0.1μF	OUT1F	40		μs
			OUT2F	25		
Enable Settling Time	t _{EN}	Settling to 0.01%, C _{OUT} = 0.1μF	OUT1F	85		μs
			OUT2F	65		
Capacitive- Load Stability Range (OUT1F, OUT2F)		I _{OUT} ≤ 10mA	0.1		10	μF
INPUT (IN1 and IN2)						
Supply Voltage	V _{IN}	Guaranteed by line regulation	OUT1F	4.3	5.5	V
			OUT2F	2.7	5.5	
REF1 Quiescent Supply Current	I _{IN}	T _A = +25°C		150	265	μA
		T _A = -40°C to +125°C			350	
REF2 Quiescent Supply Current	I _{IN}	T _A = +25°C		130	220	μA
		T _A = -40°C to +125°C			280	
Shutdown Supply Current per Reference	I _{SD}	V _{EN} = 0V		0.85	28	μA
ENABLE (EN1 and EN2)						
Enable Input Current	I _{EN}		-1		+1	μA
Enable Logic- High	V _{IH}		0.7 x V _{IN}			V
Enable Logic- Low	V _{IL}			0.3 x V _{IN}		V

MAX6072_25 Electrical Characteristics (V_{REF1}: V_{OUT1F} = 2.5V, V_{REF2}: V_{OUT2F} = 1.25V)

(V_{IN1} = V_{EN1} = V_{IN2} = V_{EN2} = +5V, I_{OUT} = 0mA, C_{OUT} = 0.1μF, T_A = -40°C to +125°C, unless otherwise noted. Typical values are at T_A = +25°C.) (Note 2)

PARAMETER	SYMBOL	CONDITIONS	MIN	TYP	MAX	UNITS
OUTPUT						
Output Voltage Accuracy (OUT1F and OUT2F)		MAX6072A_25, T _A = +25°C	-0.05		+0.05	%
		MAX6072B_25, T _A = +25°C	-0.08		+0.08	
Output Voltage Temperature Drift (OUT1F and OUT2F, Note 3)	TCV _{OUT}	MAX6072A_25		1.5	6	ppm/°C
		MAX6072B_25		2.0	8	
Output Voltage Temperature Drift Tracking (OUT1F and OUT2F) (Note 3)	ΔTC	MAX6072A_25		0.4		ppm/°C
		MAX6072B_25		0.4		
Line Regulation		OUT1F, 2.8V < V _{IN1} < 5.5V	T _A = +25°C	60	260	μV/V
			T _A = -40°C to +125°C		275	
		OUT2F, 2.75V < V _{IN2} < 5.5V	T _A = +25°C	13	190	
			T _A = -40°C to +125°C		200	
Load Regulation		0mA < I _{OUT} < 10mA, sink	OUT1F	80	185	μV/mA
				75	190	
		0mA < I _{OUT} < 10mA, source	OUT2F	70	185	
				100	190	
Dropout Voltage		I _{OUT} = 10mA, T _A = -40°C to +125°C (Note 6)	OUT1F	110	230	mV
Output Current (OUT1F and OUT2F)	I _{OUT}		-10		+10	mA
Short-Circuit Current (OUT1F and OUT2F)	I _{SC}	Sourcing to ground		25		mA
		Sinking from V _{IN}		25		
Thermal Hysteresis (Note 5)		OUT1F		85		ppm
		OUT2F		85		
Thermal Hysteresis Tracking (Note 5)		OUT2F to OUT1F		2.5		ppm
Long-Term Stability		OUT1F, 1000 hours at T _A = +25°C		15		ppm
		OUT2F, 1000 hours at T _A = +25°C		20		

**MAX6072_25 Electrical Characteristics (V_{REF1}: V_{OUT1F} = 2.5V, V_{REF2}: V_{OUT2F} = 1.25V)
(continued)**

(V_{IN1} = V_{EN1} = V_{IN2} = V_{EN2} = +5V, I_{OUT} = 0mA, C_{OUT} = 0.1μF, T_A = -40°C to +125°C, unless otherwise noted. Typical values are at T_A = +25°C.) (Note 2)

PARAMETER	SYMBOL	CONDITIONS	MIN	TYP	MAX	UNITS
Long-Term Drift Tracking				7		ppm
DYNAMIC CHARACTERISTICS						
Noise Voltage	e _{OUT}	1/f noise, 0.1Hz to 10Hz, C _{OUT} = 0.1μF	OUT1F	4.8		μV _{P-P}
			OUT2F	3.6		
		Thermal noise, 10Hz to 10kHz, C _{OUT} = 0.1μF	OUT1F	6		μV _{RMS}
			OUT2F	5		
Noise Voltage Spectral Density		Thermal noise, f = 1kHz, C _{OUT} = 0.1μF	OUT1F	60		nV/√Hz
			OUT2F	50		
Ripple Rejection		Frequency = 60Hz	OUT1F	84		dB
			OUT2F	100		
Turn-On Settling Time	t _R	Settling to 0.01%, C _{OUT} = 0.1μF	OUT1F	30		μs
			OUT2F	20		
Enable Settling Time	t _{EN}	Settling to 0.01%, C _{OUT} = 0.1μF	OUT1F	75		μs
			OUT2F	60		
Capacitive-Load Stability Range (OUT1F, OUT2F)		I _{OUT} ≤ 10mA	0.1		10	μF
INPUT (IN1 and IN2)						
Supply Voltage	V _{IN}	Guaranteed by line regulation	OUT1F	2.8	5.5	V
			OUT2F	2.75	5.5	
REF1 Quiescent Supply Current	I _{IN}	T _A = +25°C		150	245	μA
		T _A = -40°C to +125°C			320	
REF2 Quiescent Supply Current	I _{IN}	T _A = +25°C		130	210	μA
		T _A = -40°C to +125°C			260	
Shutdown Supply Current per Reference	I _{SD}	V _{EN} = 0V		0.6	28	μA

**MAX6072_25 Electrical Characteristics (V_{REF1}: V_{OUT1F} = 2.5V, V_{REF2}: V_{OUT2F} = 1.25V)
(continued)**

(V_{IN1} = V_{EN1} = V_{IN2} = V_{EN2} = +5V, I_{OUT} = 0mA, C_{OUT} = 0.1μF, T_A = -40°C to +125°C, unless otherwise noted. Typical values are at T_A = +25°C.) (Note 2)

PARAMETER	SYMBOL	CONDITIONS	MIN	TYP	MAX	UNITS
ENABLE (EN1 and EN2)						
Enable Input Current	I _{EN}		-1		+1	μA
Enable Logic-High	V _{IH}		0.7 x V _{INL}			V
Enable Logic-Low	V _{IL}			0.3 x V _{INL}		V

- Note 2:** All devices are 100% production tested at T_A = +25°C. Specifications over the entire operating temperature range are guaranteed by design and characterization. Typical specifications are at T_A = +25°C.
- Note 3:** Temperature coefficient is calculated using the “box method” which measures temperature drift as the maximum voltage variation over a specified temperature range. The unit of measurement is ppm/°C. Temperature coefficient matching (ΔTC) is calculated using the “box method” which measures temperature drift as the maximum variation of the difference between the normalized output voltages, V_{OUT2_NORM} and V_{OUT1_NORM} (over a specified temperature range). The unit of measurement is ppm/°C, V_{OUT_NORM} = [(V_{OUT}(T) - V_{OUT}(25°C))/V_{OUT}(25°C)]
- Note 4:** Dropout voltage is defined as the minimum differential voltage (V_{IN} - V_{OUT}) at which V_{OUT} decreases by 0.2% from its original value at V_{IN} = 5.0V.
- Note 5:** Thermal hysteresis is defined as the change in +25°C output voltage before and after cycling the device from T_{MAX} to T_{MIN}. Thermal hysteresis matching is defined as the difference of the thermal hysteresis for each output (OUT1 and OUT2): ΔTH = TH_{OUT2} - TH_{OUT1}
- Note 6:** Dropout voltage is defined as the minimum differential voltage (V_{IN} - V_{OUT}) at which V_{OUT} decreases by 0.2% from its original value at V_{IN} = 5.5V.

Typical Operating Characteristics

($V_{IN1} = V_{IN2} = V_{EN1} = V_{EN2} = +5.5V$ (MAX6072_50), $V_{IN1} = V_{IN2} = V_{EN1} = V_{EN2}$ (MAX6072_41 and MAX6072_25), $I_{OUT} = 0mA$, $C_{OUT} = 0.1\mu F$, $T_A = +25^\circ C$, unless otherwise noted.)

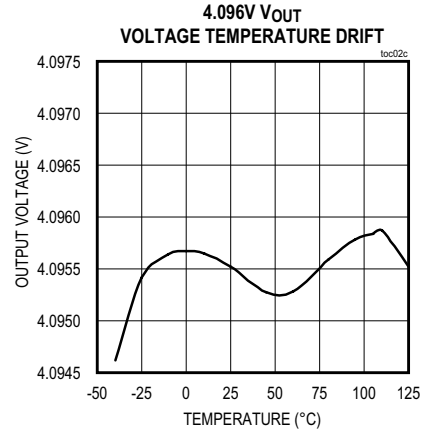
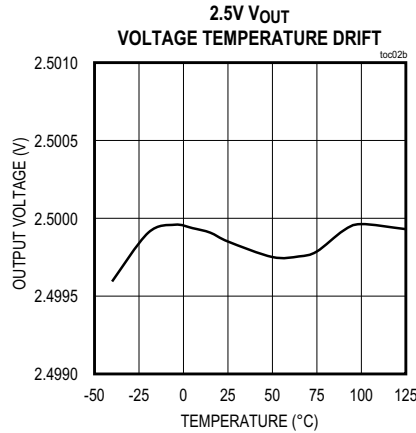
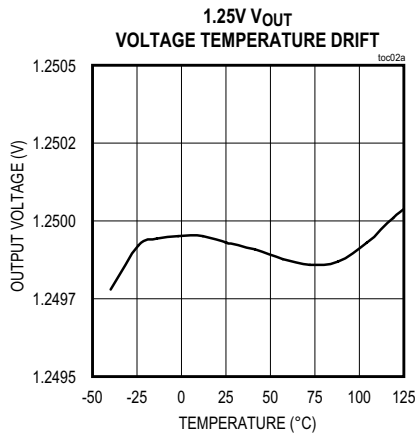
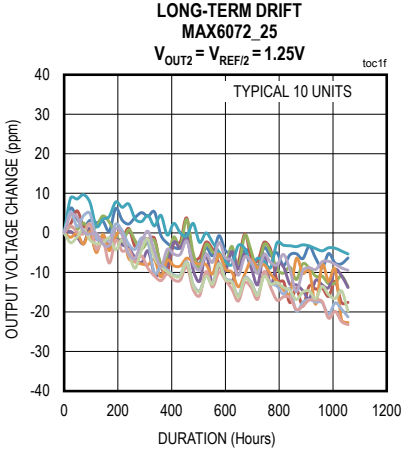
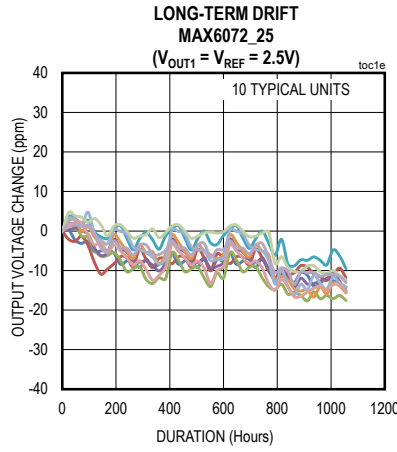
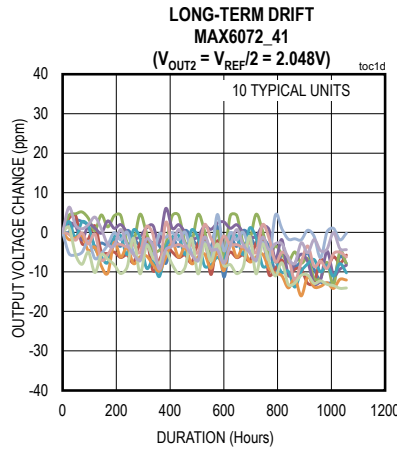
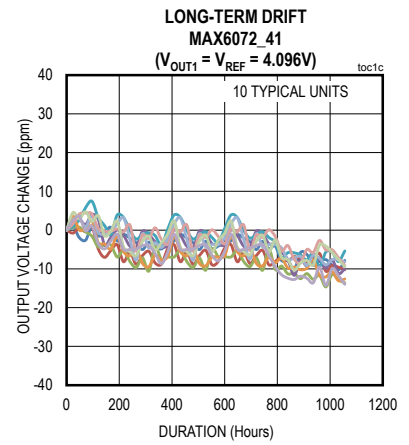
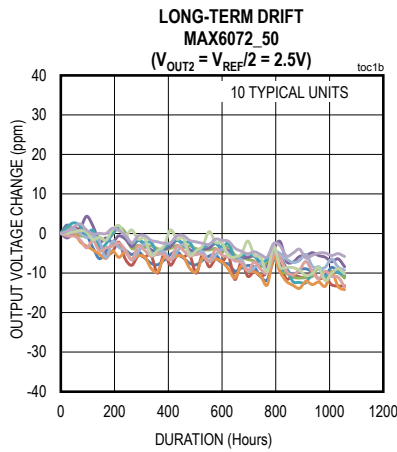
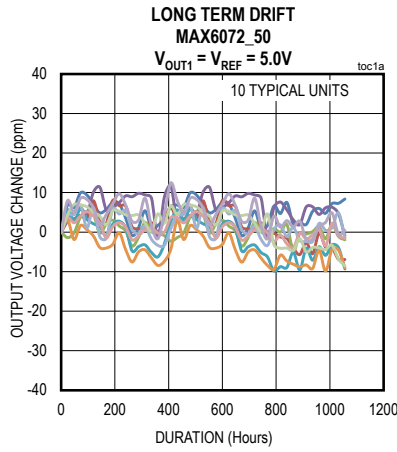

Typical Operating Characteristics (continued)

($V_{IN1} = V_{IN2} = V_{EN1} = V_{EN2} = +5.5V$ (MAX6072_50), $V_{IN1} = V_{IN2} = V_{EN1} = V_{EN2}$ (MAX6072_41 and MAX6072_25), $I_{OUT} = 0mA$, $C_{OUT} = 0.1\mu F$, $T_A = +25^\circ C$, unless otherwise noted.)

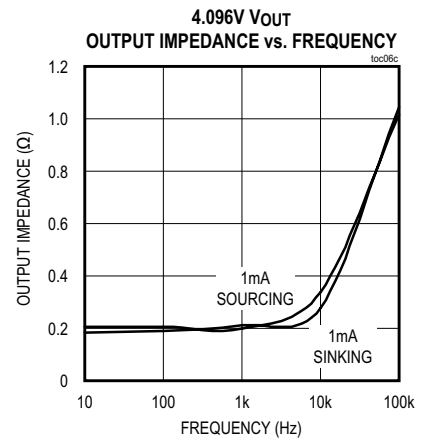
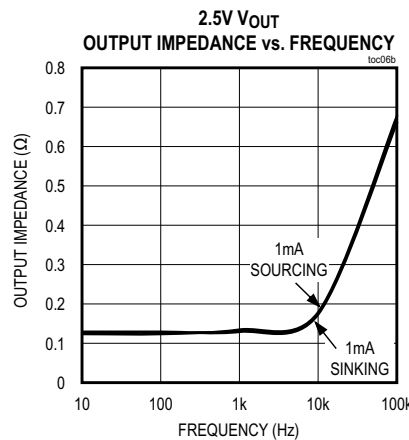
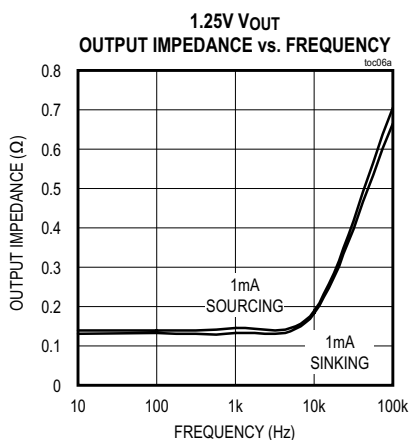
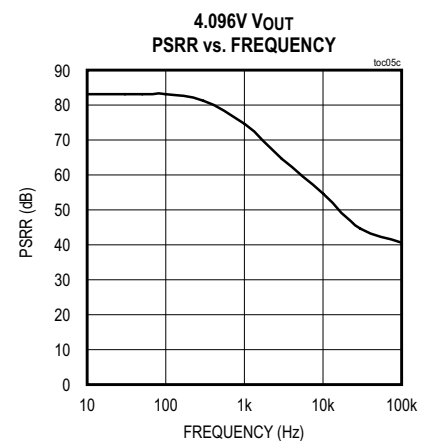
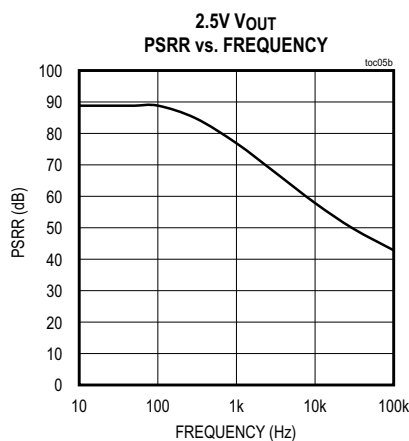
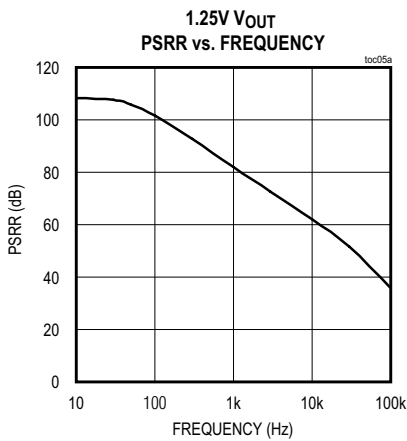
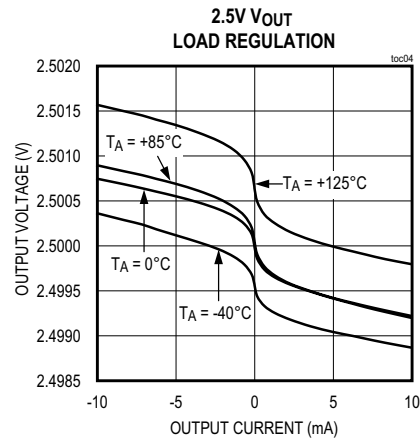
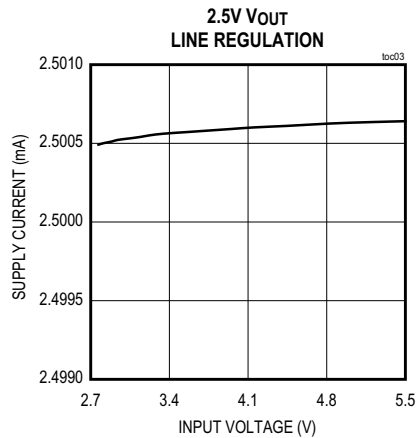

Typical Operating Characteristics (continued)

($V_{IN1} = V_{IN2} = V_{EN1} = V_{EN2} = +5.5V$ (MAX6072_50), $V_{IN1} = V_{IN2} = V_{EN1} = V_{EN2}$ (MAX6072_41 and MAX6072_25), $I_{OUT} = 0mA$, $C_{OUT} = 0.1\mu F$, $T_A = +25^\circ C$, unless otherwise noted.)

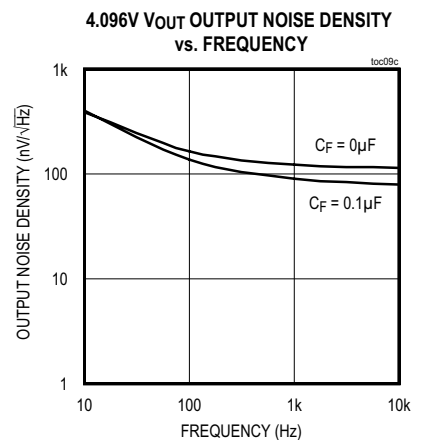
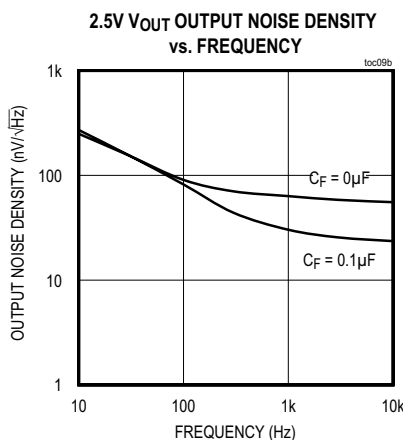
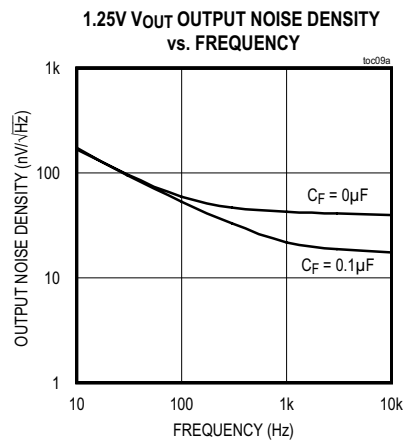
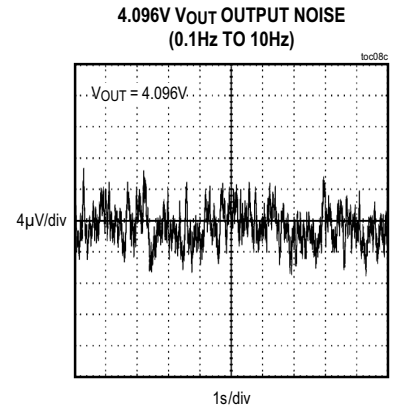
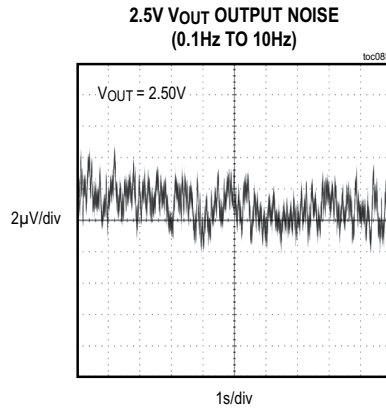
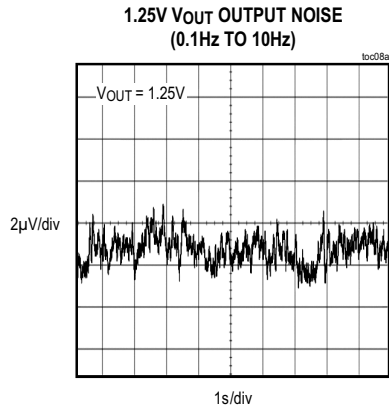
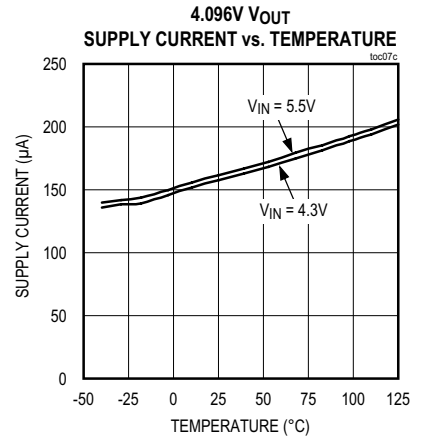
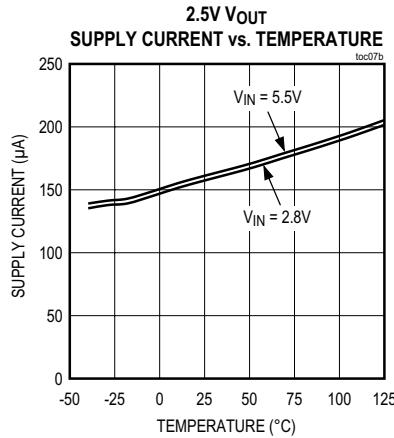
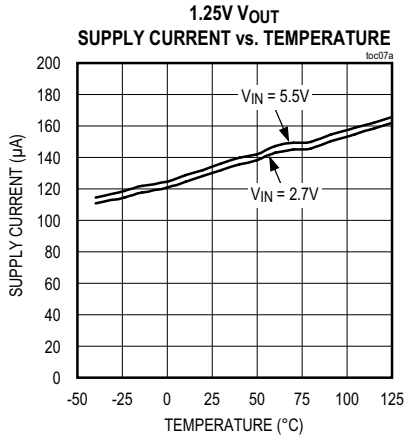

Typical Operating Characteristics (continued)

($V_{IN1} = V_{IN2} = V_{EN1} = V_{EN2} = +5.5V$ (MAX6072_50), $V_{IN1} = V_{IN2} = V_{EN1} = V_{EN2}$ (MAX6072_41 and MAX6072_25), $I_{OUT} = 0mA$, $C_{OUT} = 0.1\mu F$, $T_A = +25^\circ C$, unless otherwise noted.)

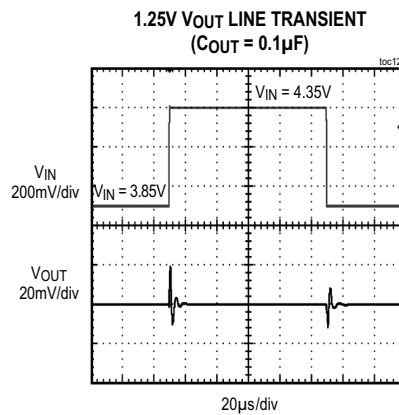
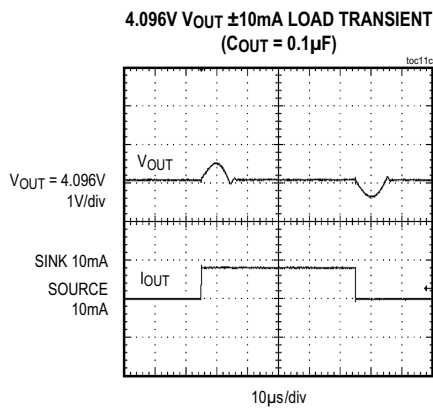
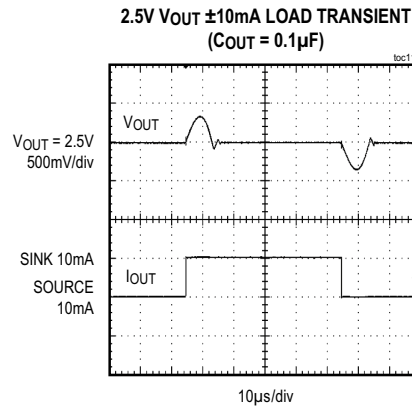
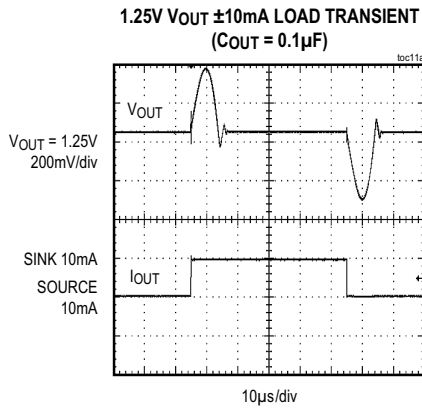
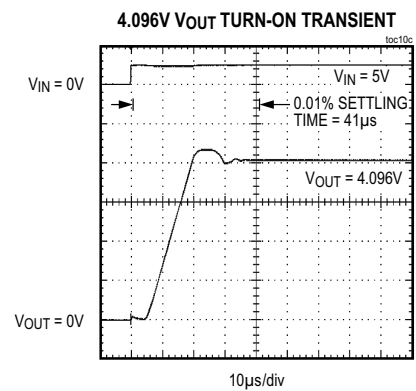
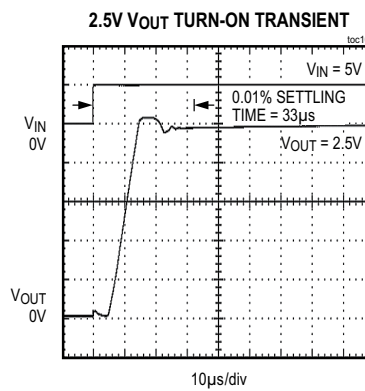
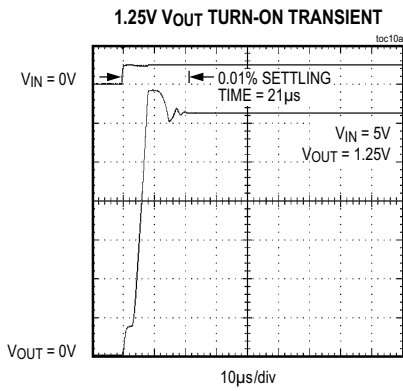

Typical Operating Characteristics (continued)

($V_{IN1} = V_{IN2} = V_{EN1} = V_{EN2} = +5.5V$ (MAX6072_50), $V_{IN1} = V_{IN2} = V_{EN1} = V_{EN2}$ (MAX6072_41 and MAX6072_25), $I_{OUT} = 0mA$, $C_{OUT} = 0.1\mu F$, $T_A = +25^\circ C$, unless otherwise noted.)

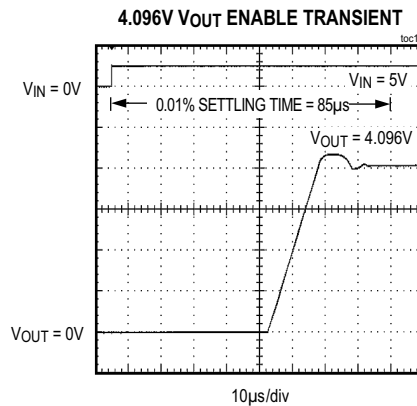
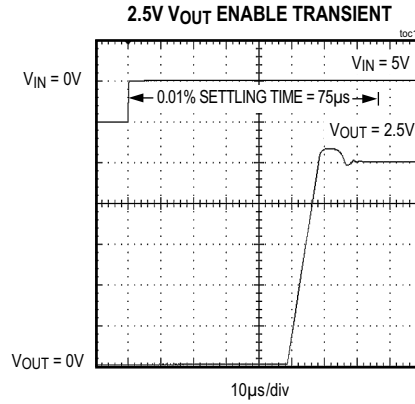
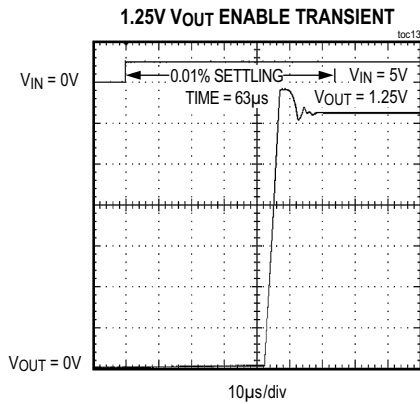
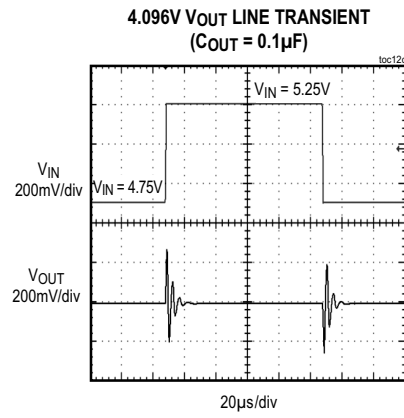
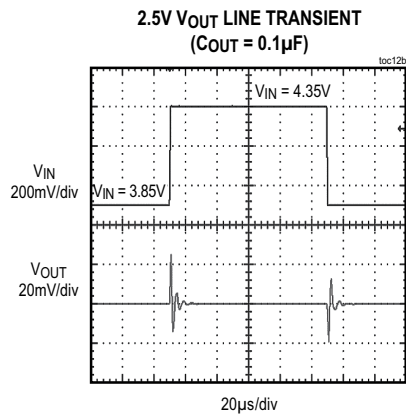

Pin Configuration

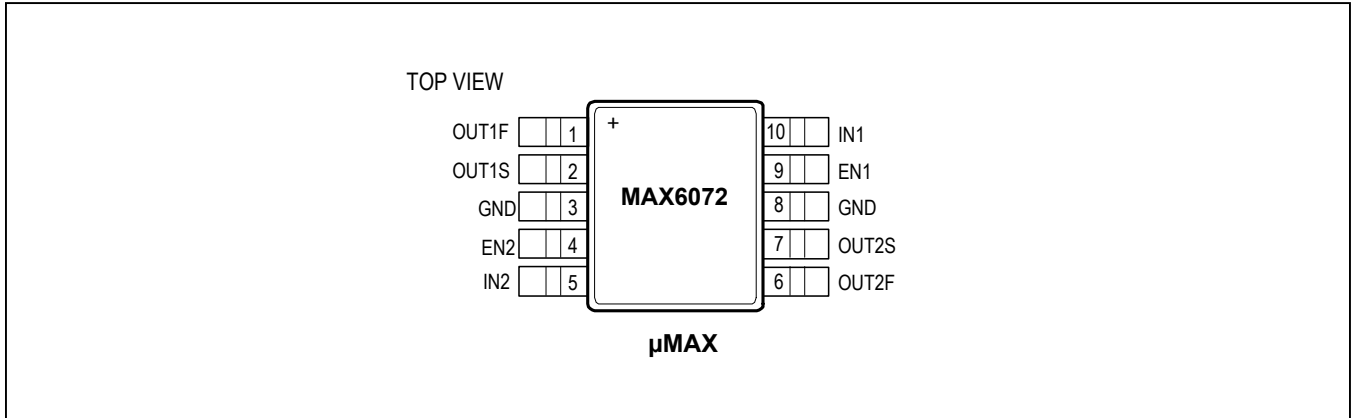

Pin Description

PIN	NAME	FUNCTION
1	OUT1F	V_{REF} Reference 1 (V_{OUT1F}) Force Output. Short OUT1F to OUT1S as close as possible to the load. Bypass with a capacitor (0.1 μ F to 10 μ F) to GND.
2	OUT1S	V_{REF} Voltage Reference 1 (V_{OUT1S}) Sense
3, 8	GND	Ground. Both the pins 3 and 8 must be externally connected to a solid ground plane.
4	EN2	Voltage Reference 2 Enable Input. Drive high to enable V_{REF2} . Drive low to disable V_{REF2} .
5	IN2	Voltage Reference 2 Supply Input
6	OUT2F	$V_{REF}/2$ Voltage Reference 2 (V_{OUT2F}) Force Output. Short OUT2F to OUT2S as close as possible to the load. Bypass with a capacitor (0.1 μ F to 10 μ F) to GND.
7	OUT2S	$V_{REF}/2$ Voltage Reference 2 (V_{OUT2S}) Sense
9	EN1	Voltage Reference 1 Enable Input. Drive high to enable V_{REF1} . Drive low to disable V_{REF1} .
10	IN1	Voltage Reference 1 Supply Input

Functional Diagram

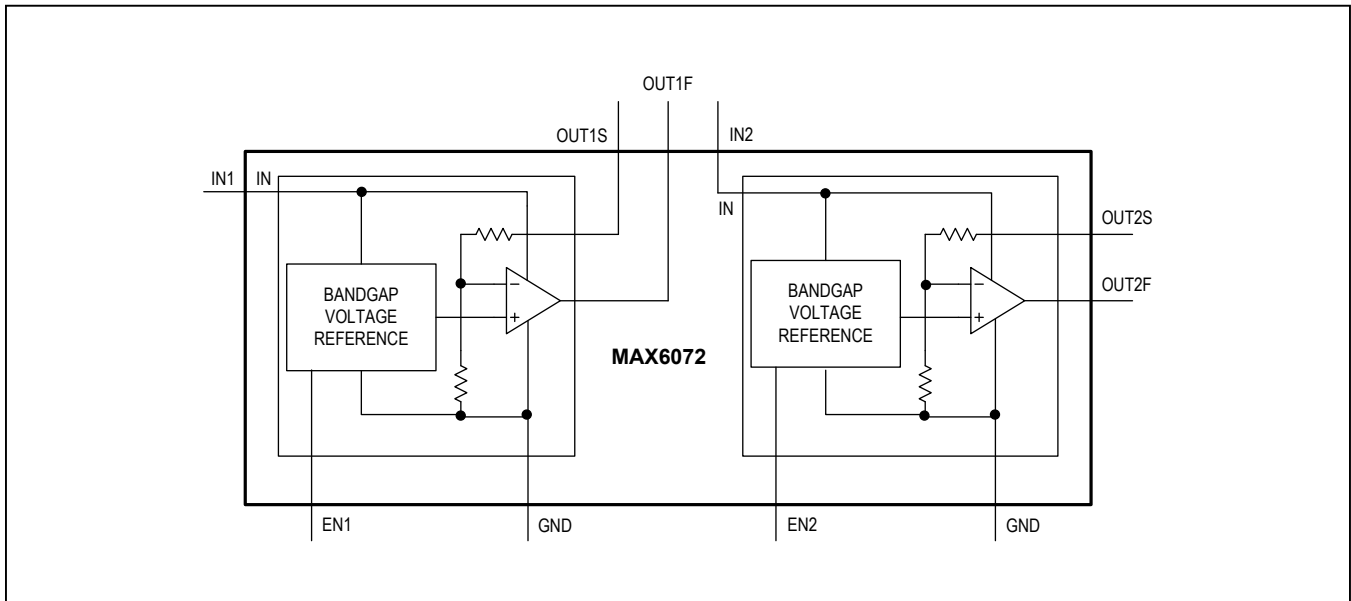

Detailed Description

Output Force and Sense

The MAX6072 provides independent Kelvin connections for the power-circuit output (OUTF) supplying current to the load and the circuit input regulating the voltage applied to that load (OUTS). This configuration allows for the cancellation of the voltage drop on the lines connecting the MAX6072 and the load. When using the Kelvin connection made possible by the independent current and voltage connections, connect OUTF to the load and connect OUTS to OUTF at the point where the voltage accuracy is most needed (see [Figure 1](#)).

Output Bypassing

The MAX6072 requires an output capacitor between 0.1µF and 10µF. Place the output capacitor as close to OUT_F as possible. For applications driving switching capacitive loads or rapidly changing load currents, use a 10µF capacitor in parallel with a 0.1µF capacitor. Larger capacitor values reduce transients on the reference output.

Supply Voltage

Each of the MAX6072 references offers individual supply voltage inputs (IN1 and IN2). IN1 supplies the power to VREF1 and IN2 for VREF2. Each of the two references can be powered up separately or from the same supply voltage by shorting IN1 and IN2 together.

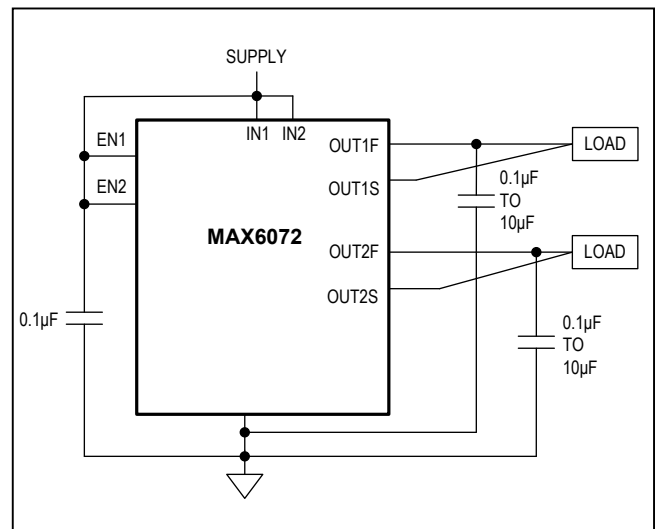

Figure 1. Reference Output Kelvin Connection

Thermal Hysteresis

Thermal hysteresis is the change of output voltage at $T_A = +25^\circ\text{C}$ before and after the device is cycled over its entire operating temperature range. The typical thermal hysteresis value is 85ppm.

Turn-On Time

The device typically turns on and settles to within 0.01% of their final value in 25 μs to 40 μs . The turn-on time can increase up to 4ms with the device operating at the minimum dropout voltage and the maximum load.

Applications Information

Accurate Reference by Using the Other Reference Output as the Supply Input

In certain applications where only a single reference is required, the dual reference can be used as a single reference output when one of its references (V_{OUT1F} where $V_{OUT1F} > V_{OUT2F}$) is used as the supply input for the second internal reference of the part (see Figure 2). By doing so, the output reference accuracy is improved as the PSRR performance improves. Since both the refer-

ences are present in the same package, they exhibit the same thermal trend in variation.

Dual Referencing Fully Differential Amplifier and ADC

Applications employing a fully differential amplifier and ADC in a signal chain typically require maintaining the input(s) at half the V_{REF} (V) for the common-mode voltage being applied to the ADC. For this purpose, either a second reference with the value $V_{REF_DIFF_AMP} = V_{REF}/2$, or an op amp is often used as output common-mode biasing. The MAX6072A/B series is used with ease in these situations, where $V_{REF_DIFF_AMP}$ can be referenced from the V_{REF2} available from the part. This way, both the V_{REF} and $V_{REF}/2$ to the ADC and the differential amplifier are provided by the same part providing improved accuracy and lesser board space. See [Figure 3](#).

The [Typical Operating Circuit](#) shows MAX6072A_41 used in a signal chain, performing single-ended to differential conversion.

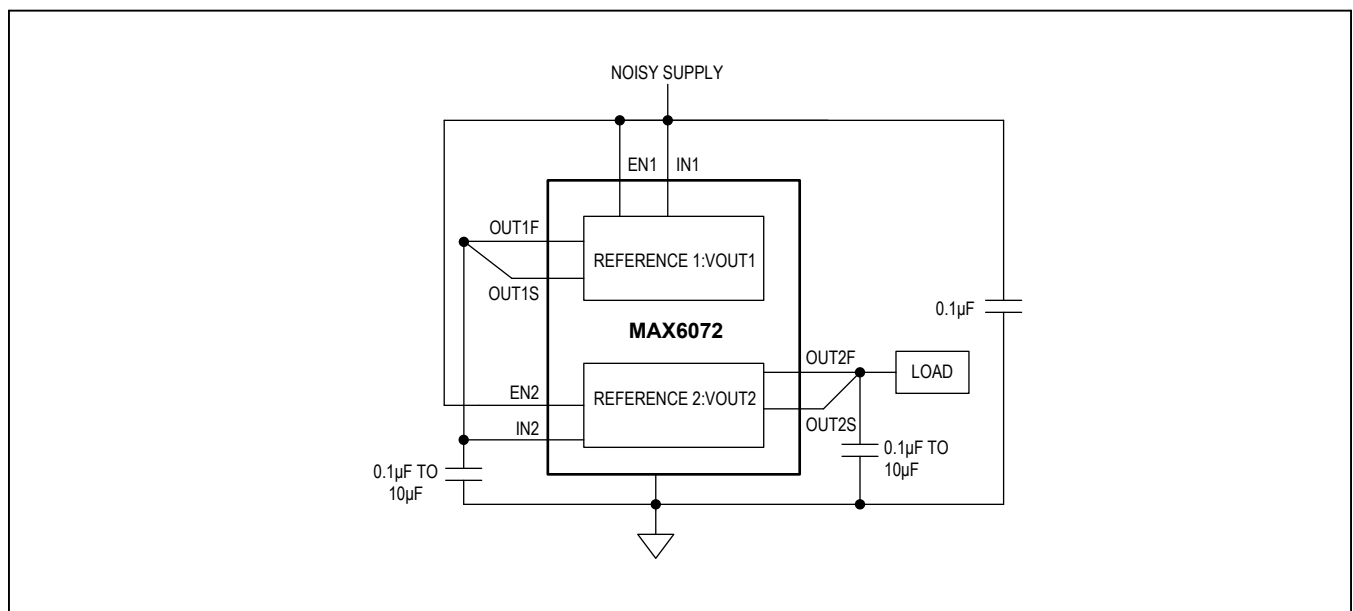

Figure 2. Increasing the Accuracy of Reference

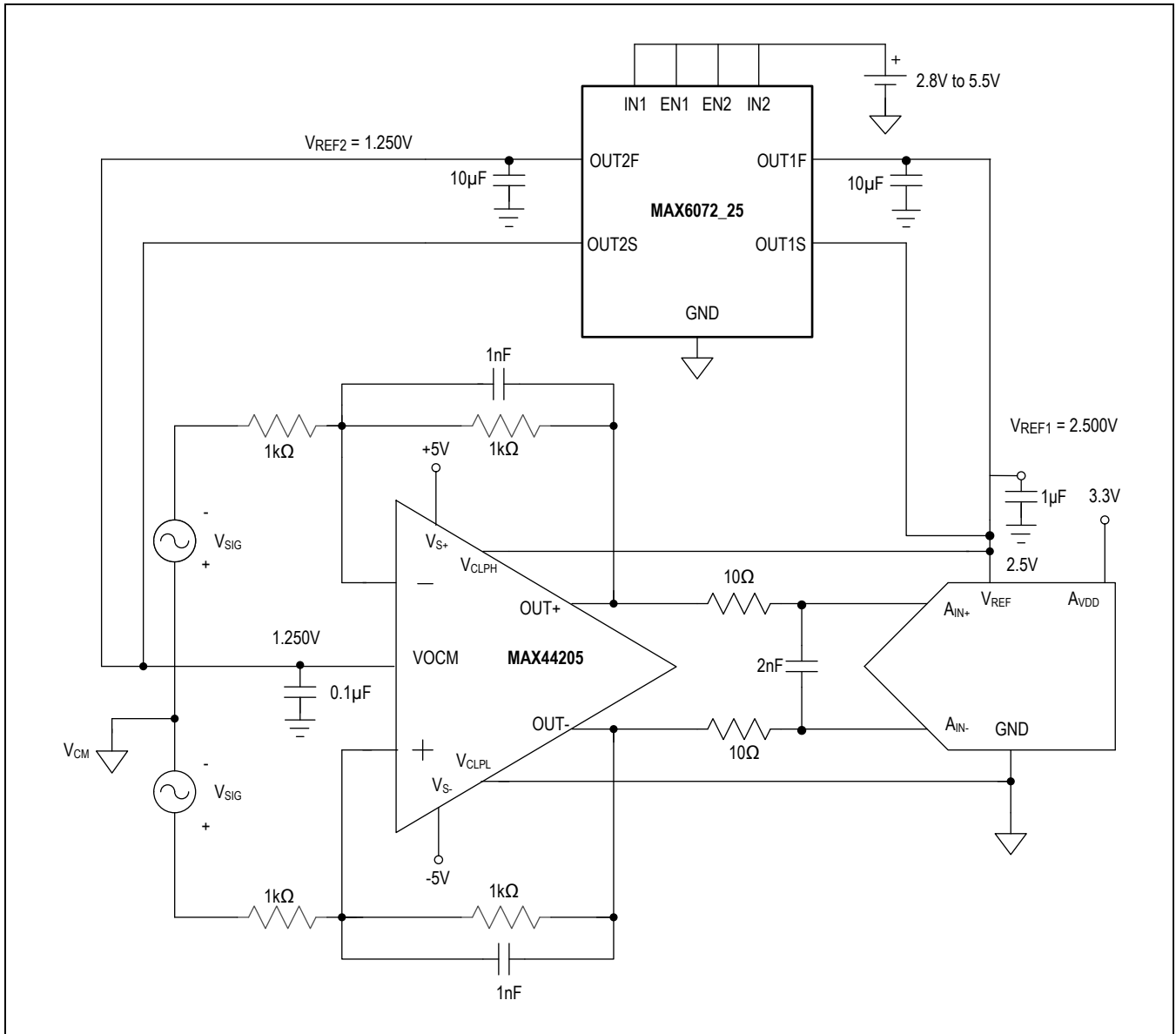
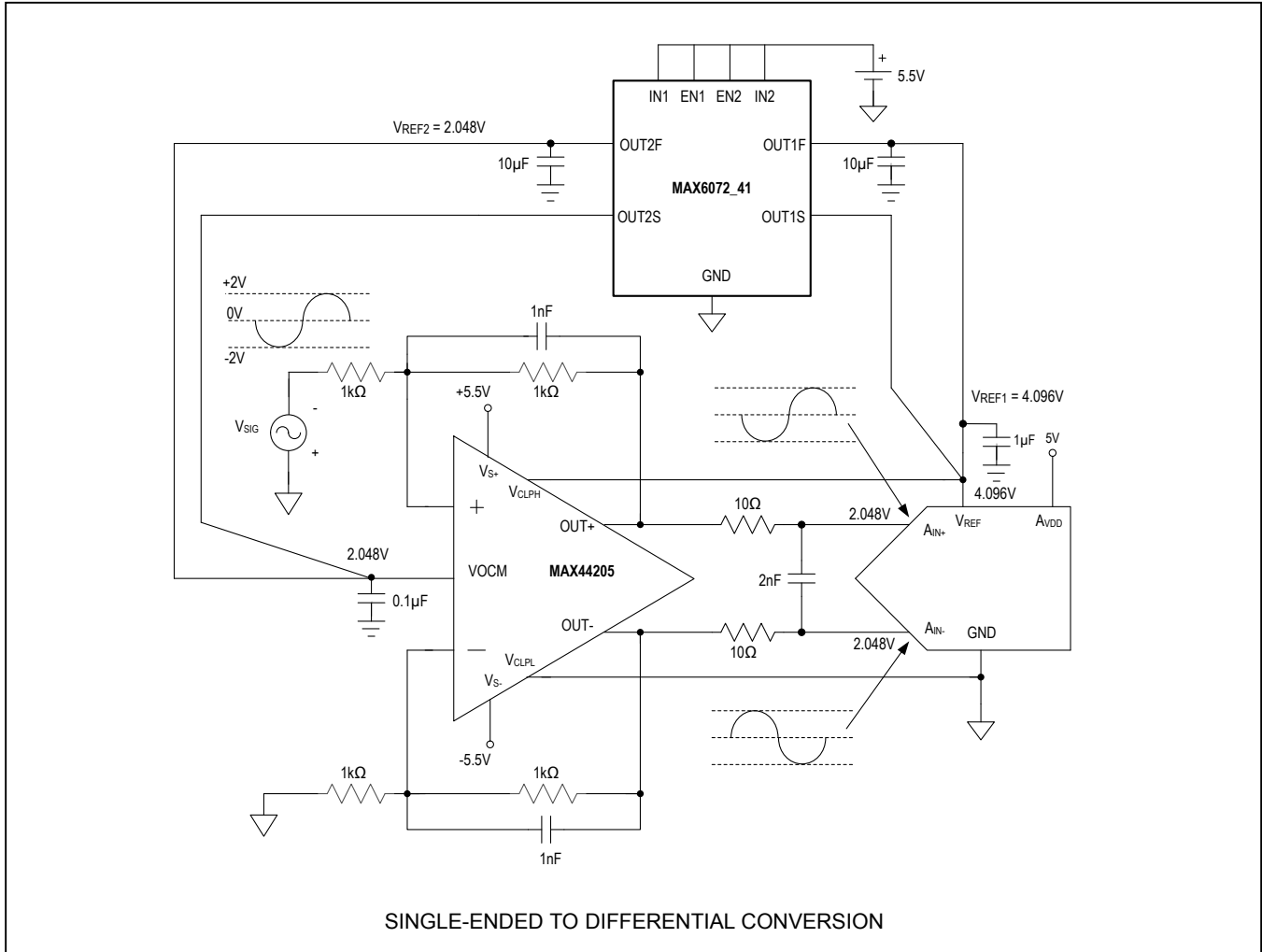

Figure 3. Fully Differential Amplifier and ADC with Dual Referencing from MAX6072_25

Typical Operating Circuit



Ordering Information

PART	PIN-PACKAGE	V _{REF1} /V _{REF2}
MAX6072AAUB25+	10 μ MAX	2.500V/1.250V
MAX6072AAUB41+	10 μ MAX	4.096V/2.048V
MAX6072AAUB50+	10 μ MAX	5.000V/2.500V
MAX6072BAUB25+	10 μ MAX	2.500V/1.250V
MAX6072BAUB41+	10 μ MAX	4.096V/2.048V
MAX6072BAUB50+	10 μ MAX	5.000V/2.500V

Note: All devices are specified over the -40°C to +125°C operating temperature range.

+Denotes a lead(Pb)-free/RoHS-compliant package.

Chip Information

PROCESS: BiCMOS

Package Information

For the latest package outline information and land patterns (footprints), go to www.maximintegrated.com/packages. Note that a "+", "#", or "-" in the package code indicates RoHS status only. Package drawings may show a different suffix character, but the drawing pertains to the package regardless of RoHS status.

PACKAGE TYPE	PACKAGE CODE	OUTLINE NO.	LAND PATTERN NO.
10 μ MAX	U10M+5	21-0061	90-0330

Revision History

REVISION NUMBER	REVISION DATE	DESCRIPTION	PAGES CHANGED
0	12/14	Initial release	—

For pricing, delivery, and ordering information, please contact Maxim Direct at 1-888-629-4642, or visit Maxim Integrated's website at www.maximintegrated.com.

Maxim Integrated cannot assume responsibility for use of any circuitry other than circuitry entirely embodied in a Maxim Integrated product. No circuit patent licenses are implied. Maxim Integrated reserves the right to change the circuitry and specifications without notice at any time. The parametric values (min and max limits) shown in the Electrical Characteristics table are guaranteed. Other parametric values quoted in this data sheet are provided for guidance.



Компания «ЭлектроПласт» предлагает заключение долгосрочных отношений при поставках импортных электронных компонентов на взаимовыгодных условиях!

Наши преимущества:

- Оперативные поставки широкого спектра электронных компонентов отечественного и импортного производства напрямую от производителей и с крупнейших мировых складов;
- Поставка более 17-ти миллионов наименований электронных компонентов;
- Поставка сложных, дефицитных, либо снятых с производства позиций;
- Оперативные сроки поставки под заказ (от 5 рабочих дней);
- Экспресс доставка в любую точку России;
- Техническая поддержка проекта, помощь в подборе аналогов, поставка прототипов;
- Система менеджмента качества сертифицирована по Международному стандарту ISO 9001;
- Лицензия ФСБ на осуществление работ с использованием сведений, составляющих государственную тайну;
- Поставка специализированных компонентов (Xilinx, Altera, Analog Devices, Intersil, Interpoint, Microsemi, Aeroflex, Peregrine, Syfer, Eurofarad, Texas Instrument, Miteq, Cobham, E2V, MA-COM, Hittite, Mini-Circuits, General Dynamics и др.);

Помимо этого, одним из направлений компании «ЭлектроПласт» является направление «Источники питания». Мы предлагаем Вам помощь Конструкторского отдела:

- Подбор оптимального решения, техническое обоснование при выборе компонента;
- Подбор аналогов;
- Консультации по применению компонента;
- Поставка образцов и прототипов;
- Техническая поддержка проекта;
- Защита от снятия компонента с производства.



Как с нами связаться

Телефон: 8 (812) 309 58 32 (многоканальный)

Факс: 8 (812) 320-02-42

Электронная почта: org@eplast1.ru

Адрес: 198099, г. Санкт-Петербург, ул. Калинина, дом 2, корпус 4, литера А.