

**Product Summary** (@ T<sub>A</sub> = +25°C)

V <sub>RRM</sub> (V)	I <sub>O</sub> (A)	V <sub>F(MAX)</sub> (V)	I <sub>R(MAX)</sub> (μA)
800	1	1.85	5

**Features and Benefits**

- Glass Passivated Die Construction
- Ideally Suited for Use in Very High Frequency Switching
- Ultra-Fast Recovery Time for High Efficiency
- Soft Recovery Characteristics
- Surge Overload Rating to 30A Peak
- **Lead-Free Finish; RoHS Compliant (Notes 1 & 2)**
- **Halogen and Antimony Free. "Green" Device (Note 3)**

**Description and Applications**

The US1KSAFS is a rectifier packaged in the SMA-FS package. Providing ultra-fast recovery time for high efficiency, this device is ideal for use in applications such as:

- Power Supply
- Smartphone Chargers
- Inverters
- Free Wheeling Diodes

**Mechanical Data**

- Case: SMA-FS
- Case Material: Molded Plastic, "Green" Molding Compound. UL Flammability Classification Rating 94V-0
- Moisture Sensitivity: Level 1 per J-STD-020
- Terminals: Finish - Matte Tin Annealed over Copper Leadframe. Solderable per MIL-STD-202, Method 208
- Polarity: Cathode Band
- Weight: 0.033 grams (Approximate)

SMA-FS

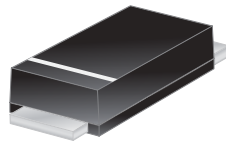

Top View

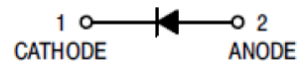

Schematic View

**Ordering Information** (Note 4)

Part Number	Qualification	Case	Packaging
US1KSAFS-13	Commercial	SMA-FS	10,000/Tape & Reel

- Notes:
1. EU Directive 2002/95/EC (RoHS) & 2011/65/EU (RoHS 2) compliant. All applicable RoHS exemptions applied.
  2. See [http://www.diodes.com/quality/lead\\_free.html](http://www.diodes.com/quality/lead_free.html) for more information about Diodes Incorporated's definitions of Halogen- and Antimony-free, "Green" and Lead-free.
  3. Halogen- and Antimony-free "Green" products are defined as those which contain <900ppm bromine, <900ppm chlorine (<1500ppm total Br + Cl) and <1000ppm antimony compounds.
  4. For packaging details, go to our website at <http://www.diodes.com/products/packages.html>.

**Marking Information**

U1KS = Product Type Marking Code  
 311 = Manufacturers' Code Marking  
 YWW = Date Code Marking  
 Y = Last Digit of Year (ex: 6 for 2016)  
 WW = Week Code (01 to 53)

**Maximum Ratings** (@T<sub>A</sub> = +25°C, unless otherwise specified.)

Single phase, half wave, 60Hz, resistive or inductive load.  
For capacitive load, derate current by 20%.

Characteristic	Symbol	Value	Unit
Peak Repetitive Reverse Voltage	V <sub>RRM</sub>	800	V
Working Peak Reverse Voltage	V <sub>RWM</sub>		
DC Blocking Voltage (Note 5)	V <sub>R</sub>		
RMS Reverse Voltage	V <sub>R(RMS)</sub>	560	V
Average Rectified Output Current @T <sub>A</sub> = +40°C	I <sub>O</sub>	1.0	A
Non-Repetitive Peak Forward Surge Current 8.3ms Single Half Sine-Wave Superimposed on Rated Load	I <sub>FSM</sub>	30	A
Maximum Full Load Reverse Current, Full Cycle Average, 0.375"(9.5mm) Length at T <sub>A</sub> = +55°C	I <sub>R(AV)</sub>	100	μA

**Thermal Characteristics**

Characteristic	Symbol	Value	Unit
Typical Thermal Resistance, Junction to Case (Note 8)	R <sub>θJC</sub>	25	°C/W
Typical Thermal Resistance, Junction to Ambient (Note 8)	R <sub>θJA</sub>	150	°C/W
Operating and Storage Temperature Range	T <sub>J</sub> , T <sub>STG</sub>	-55 to +150	°C

**Electrical Characteristics** (@T<sub>A</sub> = +25°C, unless otherwise specified.)

Characteristic	Symbol	Value	Unit
Reverse Breakdown Voltage (Note 5) @I <sub>R</sub> = 5μA	V <sub>(BR)R</sub>	800	V
Maximum Forward Voltage Drop @I <sub>F</sub> = 1.0A	V <sub>F</sub>	1.85	V
Peak Reverse Current @T <sub>A</sub> = +25°C	I <sub>R</sub>	5.0	μA
at Rated DC Blocking Voltage (Note 5) @T <sub>A</sub> = +100°C		50	
Maximum Reverse Recovery Time (Note 6)	t <sub>RR</sub>	75	ns
Typical Total Capacitance (Note 7)	C <sub>T</sub>	5	pF

- Notes:
5. Short duration pulse test used to minimize self-heating effect.
  6. Measured with I<sub>F</sub> = 0.5A, I<sub>R</sub> = 1.0A, I<sub>RR</sub> = 0.25A. See figure 7.
  7. Measured at 1.0MHz and applied reverse voltage of 4.0V DC.
  8. Device mounted on FR-4 substrate, 1"x1", 2oz, single-sided, PC boards with 0.1"x0.15" copper pad.
  9. Device mounted on FR-4 substrate, 0.4"x0.5", 2oz, single-sided, PC boards with 0.2"x0.25" copper pad.

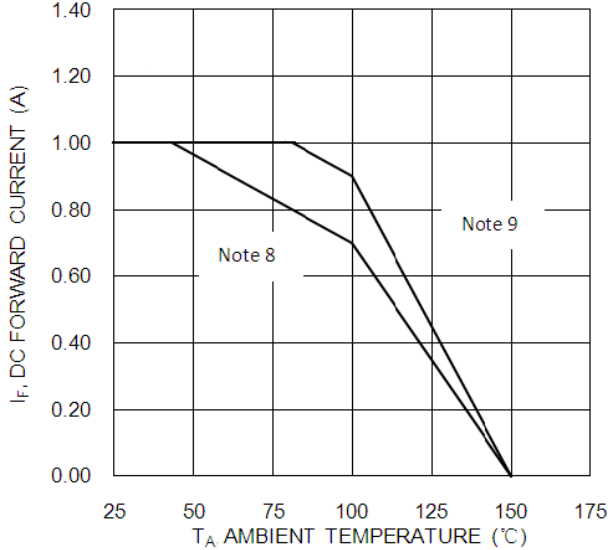

Figure 1. DC Forward Current Derating

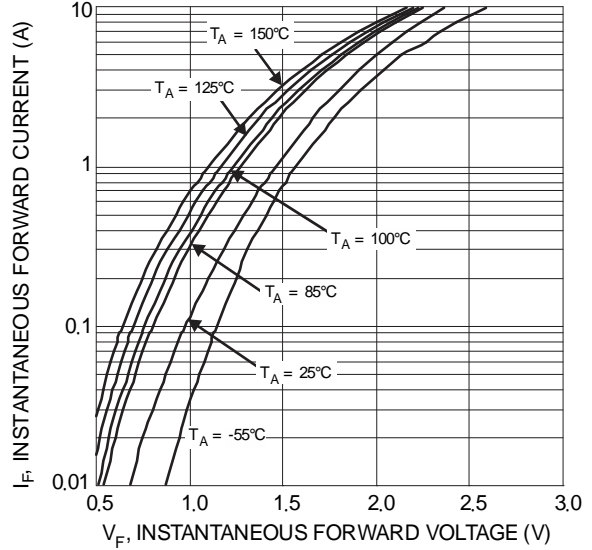

Figure 2 Typical Forward Characteristics

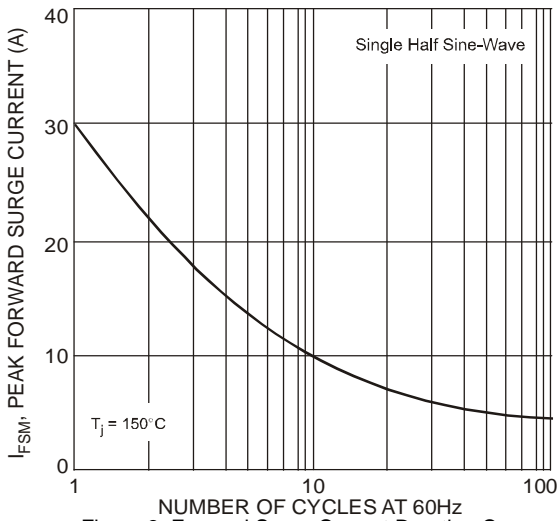

Figure 3. Forward Surge Current Derating Curve

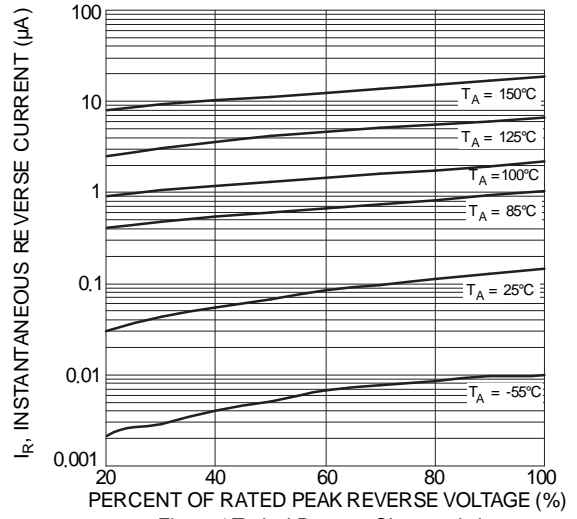

Figure 4 Typical Reverse Characteristics

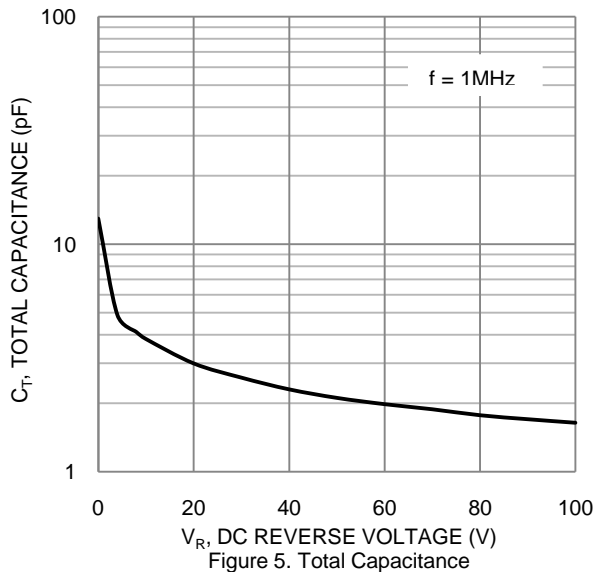

Figure 5. Total Capacitance

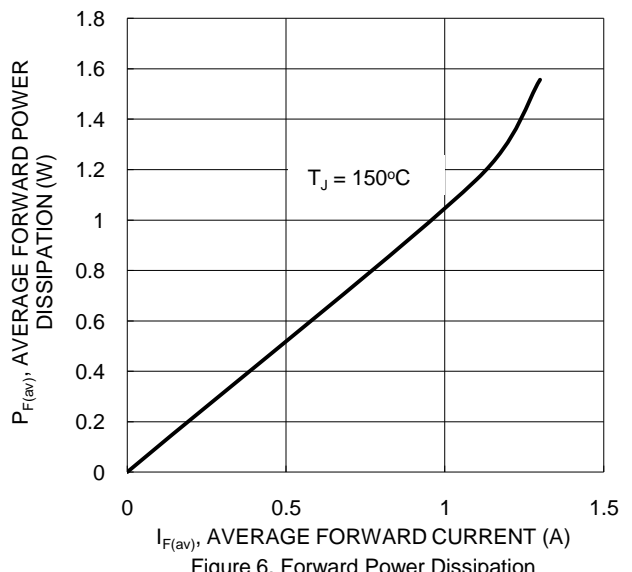
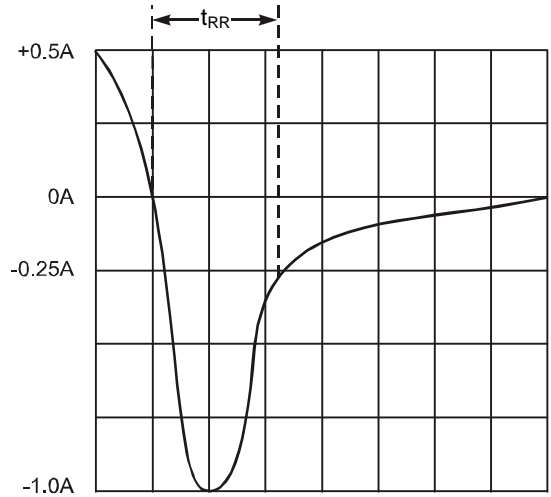
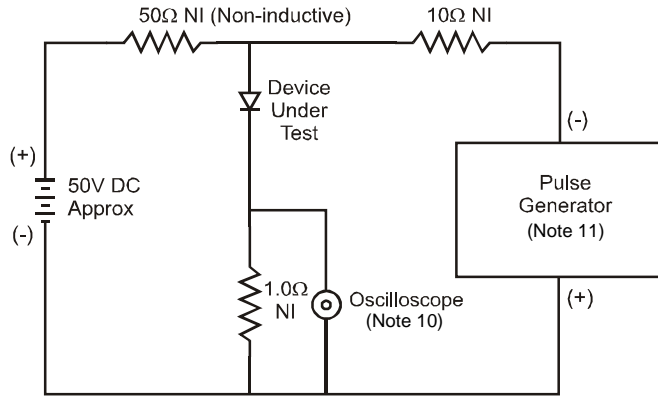

Figure 6. Forward Power Dissipation



Set time base for 50/100 ns/cm

Notes:  
10. Rise Time = 7.0ns max. Input Impedance = 1.0MΩ, 22pF.  
11. Rise Time = 10ns max. Input Impedance = 50Ω.

Figure 7. Reverse Recovery Time Characteristic and Test Circuit

## Package Outline Dimensions

Please see <http://www.diodes.com/package-outlines.html> for the latest version.

### SMA-FS

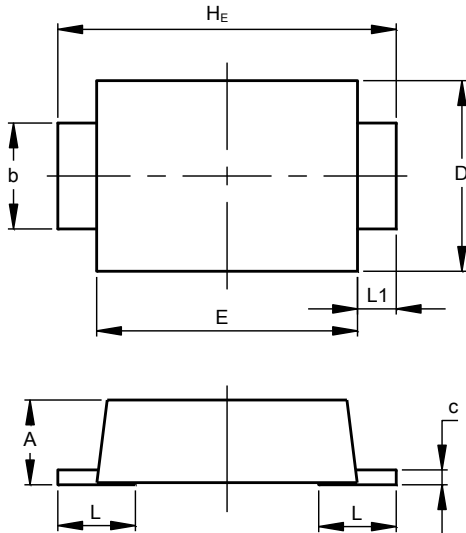

SMA-FS		
Dim	Min	Max
A	0.90	1.20
b	1.30	1.50
c	0.11	0.21
D	2.30	2.70
E	3.30	3.70
HE	4.40	4.80
L	0.70	1.10
L1	0.45	0.65
All Dimensions in mm		

## Suggested Pad Layout

Please see <http://www.diodes.com/package-outlines.html> for the latest version.

### SMA-FS

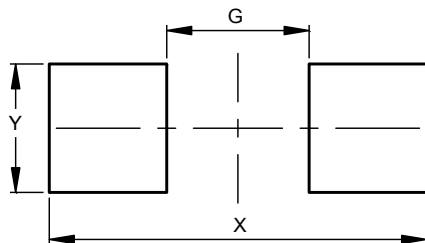

Dimensions	Value (in mm)
G	2.10
X	5.30
Y	1.77

**IMPORTANT NOTICE**

DIODES INCORPORATED MAKES NO WARRANTY OF ANY KIND, EXPRESS OR IMPLIED, WITH REGARDS TO THIS DOCUMENT, INCLUDING, BUT NOT LIMITED TO, THE IMPLIED WARRANTIES OF MERCHANTABILITY AND FITNESS FOR A PARTICULAR PURPOSE (AND THEIR EQUIVALENTS UNDER THE LAWS OF ANY JURISDICTION).

Diodes Incorporated and its subsidiaries reserve the right to make modifications, enhancements, improvements, corrections or other changes without further notice to this document and any product described herein. Diodes Incorporated does not assume any liability arising out of the application or use of this document or any product described herein; neither does Diodes Incorporated convey any license under its patent or trademark rights, nor the rights of others. Any Customer or user of this document or products described herein in such applications shall assume all risks of such use and will agree to hold Diodes Incorporated and all the companies whose products are represented on Diodes Incorporated website, harmless against all damages.

Diodes Incorporated does not warrant or accept any liability whatsoever in respect of any products purchased through unauthorized sales channel. Should Customers purchase or use Diodes Incorporated products for any unintended or unauthorized application, Customers shall indemnify and hold Diodes Incorporated and its representatives harmless against all claims, damages, expenses, and attorney fees arising out of, directly or indirectly, any claim of personal injury or death associated with such unintended or unauthorized application.

Products described herein may be covered by one or more United States, international or foreign patents pending. Product names and markings noted herein may also be covered by one or more United States, international or foreign trademarks.

This document is written in English but may be translated into multiple languages for reference. Only the English version of this document is the final and determinative format released by Diodes Incorporated.

**LIFE SUPPORT**

Diodes Incorporated products are specifically not authorized for use as critical components in life support devices or systems without the express written approval of the Chief Executive Officer of Diodes Incorporated. As used herein:

A. Life support devices or systems are devices or systems which:

1. are intended to implant into the body, or
2. support or sustain life and whose failure to perform when properly used in accordance with instructions for use provided in the labeling can be reasonably expected to result in significant injury to the user.

B. A critical component is any component in a life support device or system whose failure to perform can be reasonably expected to cause the failure of the life support device or to affect its safety or effectiveness.

Customers represent that they have all necessary expertise in the safety and regulatory ramifications of their life support devices or systems, and acknowledge and agree that they are solely responsible for all legal, regulatory and safety-related requirements concerning their products and any use of Diodes Incorporated products in such safety-critical, life support devices or systems, notwithstanding any devices- or systems-related information or support that may be provided by Diodes Incorporated. Further, Customers must fully indemnify Diodes Incorporated and its representatives against any damages arising out of the use of Diodes Incorporated products in such safety-critical, life support devices or systems.

Copyright © 2016, Diodes Incorporated

[www.diodes.com](http://www.diodes.com)



Компания «ЭлектроПласт» предлагает заключение долгосрочных отношений при поставках импортных электронных компонентов на взаимовыгодных условиях!

Наши преимущества:

- Оперативные поставки широкого спектра электронных компонентов отечественного и импортного производства напрямую от производителей и с крупнейших мировых складов;
- Поставка более 17-ти миллионов наименований электронных компонентов;
- Поставка сложных, дефицитных, либо снятых с производства позиций;
- Оперативные сроки поставки под заказ (от 5 рабочих дней);
- Экспресс доставка в любую точку России;
- Техническая поддержка проекта, помощь в подборе аналогов, поставка прототипов;
- Система менеджмента качества сертифицирована по Международному стандарту ISO 9001;
- Лицензия ФСБ на осуществление работ с использованием сведений, составляющих государственную тайну;
- Поставка специализированных компонентов (Xilinx, Altera, Analog Devices, Intersil, Interpoint, Microsemi, Aeroflex, Peregrine, Syfer, Eurofarad, Texas Instrument, Miteq, Cobham, E2V, MA-COM, Hittite, Mini-Circuits, General Dynamics и др.);

Помимо этого, одним из направлений компании «ЭлектроПласт» является направление «Источники питания». Мы предлагаем Вам помощь Конструкторского отдела:

- Подбор оптимального решения, техническое обоснование при выборе компонента;
- Подбор аналогов;
- Консультации по применению компонента;
- Поставка образцов и прототипов;
- Техническая поддержка проекта;
- Защита от снятия компонента с производства.



#### Как с нами связаться

**Телефон:** 8 (812) 309 58 32 (многоканальный)

**Факс:** 8 (812) 320-02-42

**Электронная почта:** [org@eplast1.ru](mailto:org@eplast1.ru)

**Адрес:** 198099, г. Санкт-Петербург, ул. Калинина, дом 2, корпус 4, литера А.