



| Parameter                        | Rating | Units |
|----------------------------------|--------|-------|
| Breakdown Voltage $BV_{CEO}$     | 30     | $V_P$ |
| Current Transfer Ratio (Typical) | 300    | %     |
| Saturation Voltage               | 0.5    | V     |
| Input Control Current            | 1      | mA    |

### Features

- 3750V<sub>rms</sub> Input/Output Isolation
- Low Drive Power Requirements (TTL/CMOS Compatible)
- No Moving Parts
- High Reliability
- Arc-Free With No Snubbing Circuits
- No EMI/RFI Generation
- Small 6-Pin Package, Thru-Hole or Surface Mount
- Machine Insertable, Wave Solderable
- Surface Mount Tape & Reel Version Available

### Applications

- Telecom Switching
- Tip/Ring Circuits
- Modem Switching (Laptop, Notebook, Pocket Size)
- Loop Detect
- Ringing Detect
- Current Sensing

### Description

The LDA100 is a bidirectional-input optocoupler with a single-transistor output. Optically coupled technology provides a 3750V<sub>rms</sub> isolation barrier between the input and the output.

### Approvals

- UL Recognized Component: File E76270
- CSA Certified Component: Certificate 1175739
- EN/IEC 60950-1 Certified Component:  
TUV Certificate B 09 07 49410 006

### Ordering Information

| Part Number | Description                     |
|-------------|---------------------------------|
| LDA100      | 6-Pin DIP (50/Tube)             |
| LDA100S     | 6-Pin Surface Mount (50/Tube)   |
| LDA100STR   | 6-Pin Surface Mount (1000/Reel) |

### Pin Configuration

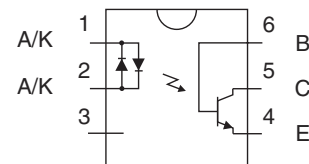

### Absolute Maximum Ratings @ 25°C

| Parameter                          | Ratings     | Units            |
|------------------------------------|-------------|------------------|
| Breakdown Voltage                  | 30          | V <sub>P</sub>   |
| Input Control Current              | 50          | mA               |
| Peak (10ms)                        | 1           | A                |
| Power Dissipation                  |             |                  |
| Input <sup>1</sup>                 | 150         | mW               |
| Phototransistors <sup>2</sup>      | 150         |                  |
| Isolation Voltage, Input to Output | 3750        | V <sub>rms</sub> |
| Operational Temperature            | -40 to +85  | °C               |
| Storage Temperature                | -40 to +125 | °C               |

<sup>1</sup> Derate linearly 1.33mW / °C

<sup>2</sup> Derate linearly 2mW / °C

Absolute Maximum Ratings are stress ratings. Stresses in excess of these ratings can cause permanent damage to the device. Functional operation of the device at conditions beyond those indicated in the operational sections of this data sheet is not implied.

### Electrical Characteristics @ 25°C (Unless Otherwise Noted)

| Parameters                        | Conditions                                    | Symbol               | Min | Typ | Max | Units |
|-----------------------------------|---|----------------------|-----|-----|-----|-------|
| <b>Output Characteristics</b>     |   |                      |     |     |     |       |
| Phototransistor Breakdown Voltage | I <sub>C</sub> =10μA                          | BV <sub>CEO</sub>    | 30  | 85  | -   | V     |
| Phototransistor Dark Current      | V <sub>CE</sub> =5V, I <sub>F</sub> =0mA      | I <sub>CEO</sub>     | -   | -   | 500 | nA    |
| Saturation Voltage                | I <sub>C</sub> =2mA, I <sub>F</sub> =1mA      | V <sub>CE(sat)</sub> | -   | -   | 0.5 | V     |
| Current Transfer Ratio            | I <sub>F</sub> =1mA, V <sub>CE</sub> =0.5V    | CTR                  | 33  | 300 | -   | %     |
| Output Capacitance                | 25V, f=1MHz                                   | C <sub>OUT</sub>     | -   | 6   | -   | pF    |
| <b>Input Characteristics</b>      |   |                      |     |     |     |       |
| Input Control Current             | I <sub>C</sub> =0.33mA, V <sub>CE</sub> =0.5V | I <sub>F</sub>       | -   | -   | 1   | mA    |
| Input Voltage Drop                | I <sub>F</sub> =5mA                           | V <sub>F</sub>       | 0.9 | 1.2 | 1.4 | V     |
| <b>Common Characteristics</b>     |   |                      |     |     |     |       |
| Input to Output Capacitance       | -   | C <sub>I/O</sub>     | -   | 3   | -   | pF    |

### Switching Characteristics @ 25°C

| Characteristic | Symbol           | Test Condition  | Typ | Units |
|----------------|------------------|---|-----|-------|
| Turn-On Time   | t <sub>on</sub>  | V <sub>CC</sub> =5V, I <sub>F</sub> =2mA, R <sub>L</sub> =1KΩ | 7   | μs    |
| Turn-Off Time  | t <sub>off</sub> |   | 20  |       |

Switching Time Test Circuit

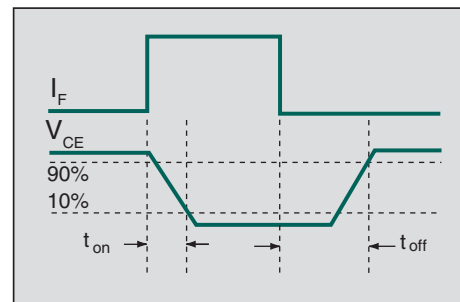
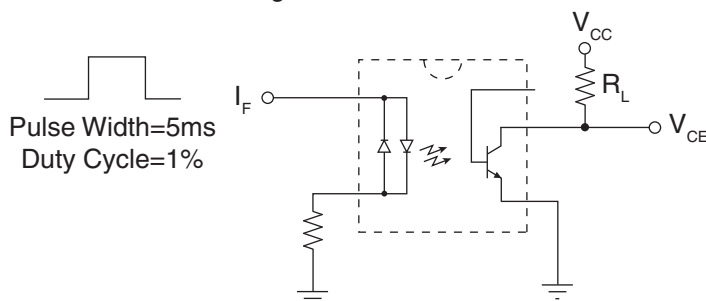

PERFORMANCE DATA @25°C (Unless Otherwise Noted)\*

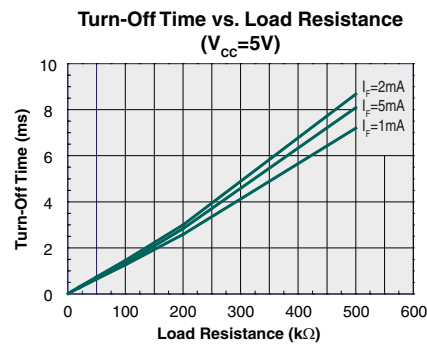
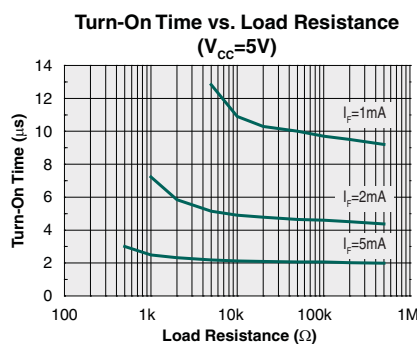
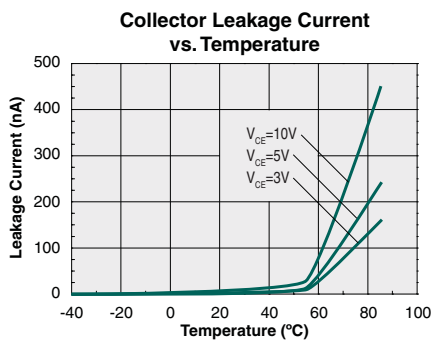
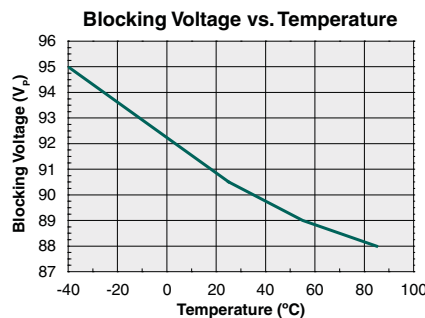
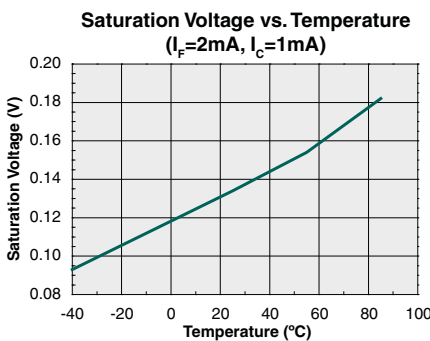
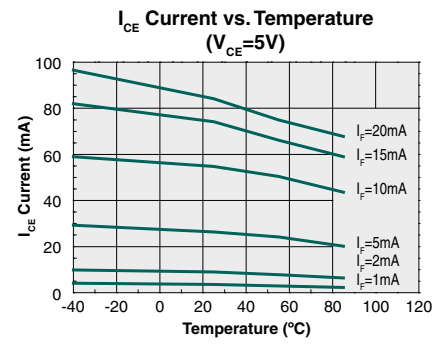
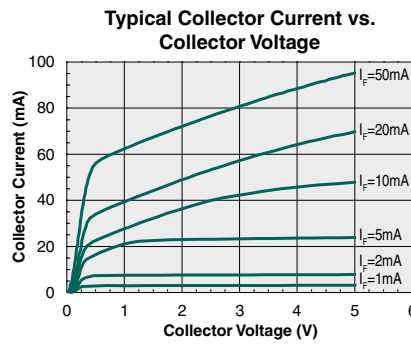
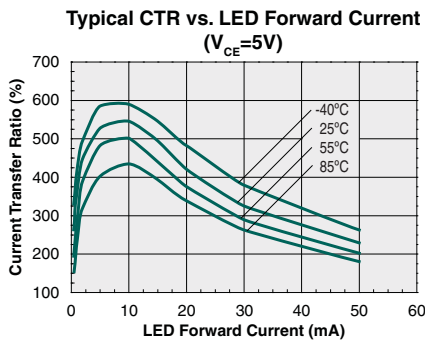
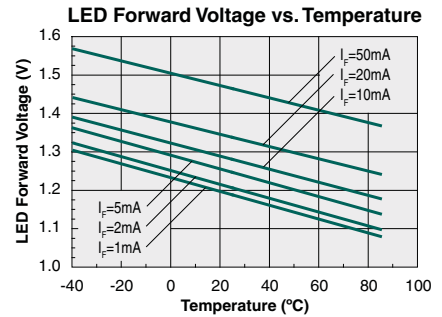
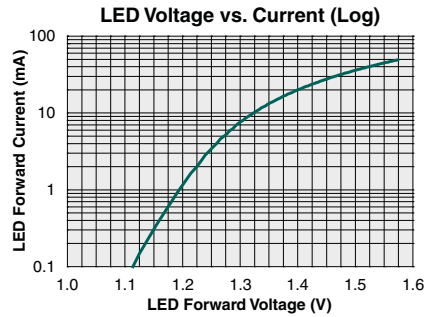
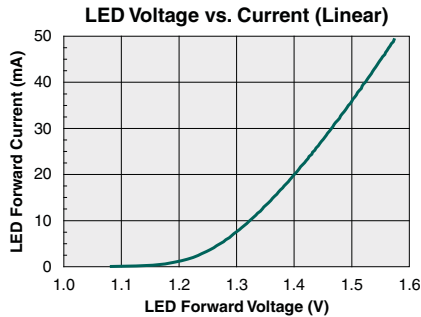

\*The Performance data shown in the graphs above is typical of device performance. For guaranteed parameters not indicated in the written specifications, please contact our application department.

## Manufacturing Information

### Moisture Sensitivity



All plastic encapsulated semiconductor packages are susceptible to moisture ingress. IXYS Integrated Circuits Division classified all of its plastic encapsulated devices for moisture sensitivity according to the latest version of the joint industry standard, **IPC/JEDEC J-STD-020**, in force at the time of product evaluation. We test all of our products to the maximum conditions set forth in the standard, and guarantee proper operation of our devices when handled according to the limitations and information in that standard as well as to any limitations set forth in the information or standards referenced below.

Failure to adhere to the warnings or limitations as established by the listed specifications could result in reduced product performance, reduction of operable life, and/or reduction of overall reliability.

This product carries a **Moisture Sensitivity Level (MSL) rating** as shown below, and should be handled according to the requirements of the latest version of the joint industry standard **IPC/JEDEC J-STD-033**.

| Device           | Moisture Sensitivity Level (MSL) Rating |
|------------------|---|
| LDA100 / LDA100S | MSL 1                                   |

### ESD Sensitivity



This product is **ESD Sensitive**, and should be handled according to the industry standard **JESD-625**.

### Reflow Profile

This product has a maximum body temperature and time rating as shown below. All other guidelines of **J-STD-020** must be observed.

| Device           | Maximum Temperature x Time |
|------------------|----------------------------|
| LDA100 / LDA100S | 250°C for 30 seconds       |

### Board Wash

IXYS Integrated Circuits Division recommends the use of no-clean flux formulations. However, board washing to remove flux residue is acceptable. Since IXYS Integrated Circuits Division employs the use of silicone coating as an optical waveguide in many of its optically isolated products, the use of a short drying bake could be necessary if a wash is used after solder reflow processes. Chlorine- or Fluorine-based solvents or fluxes should not be used. Cleaning methods that employ ultrasonic energy should not be used.



**Mechanical Dimensions**

**LDA100**

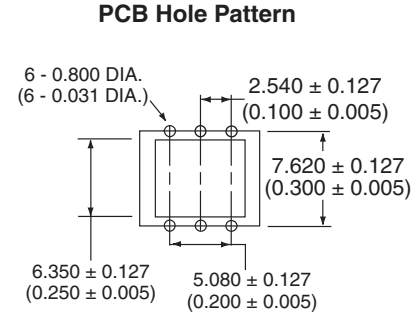
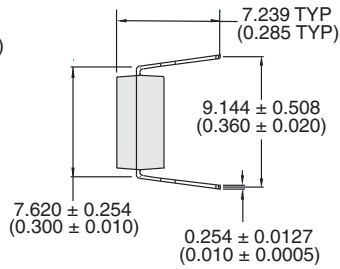
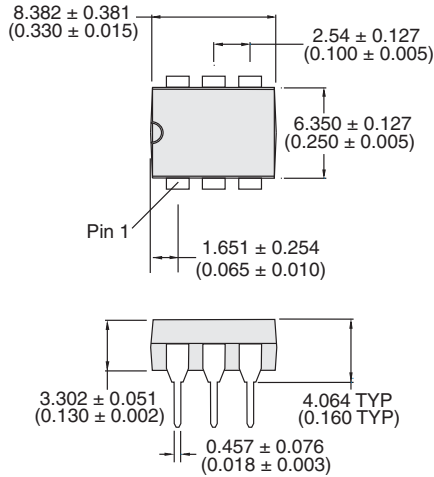

Dimensions  
mm  
(inches)

**LDA100S**

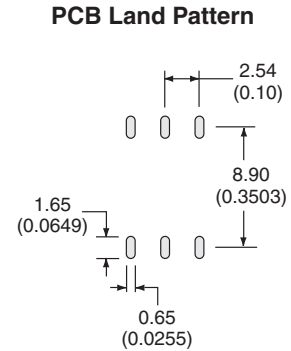
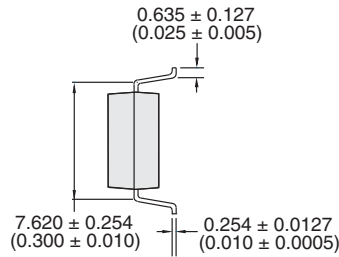
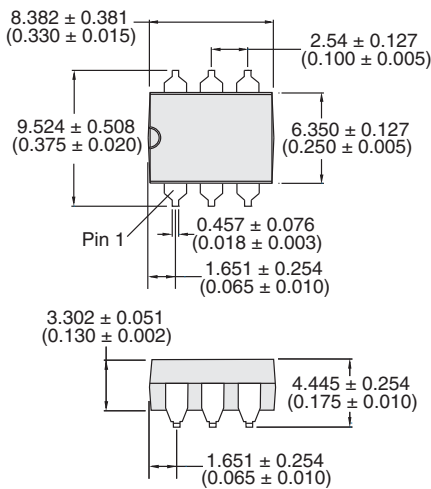

Dimensions  
mm  
(inches)

## LDA100STR Tape & Reel

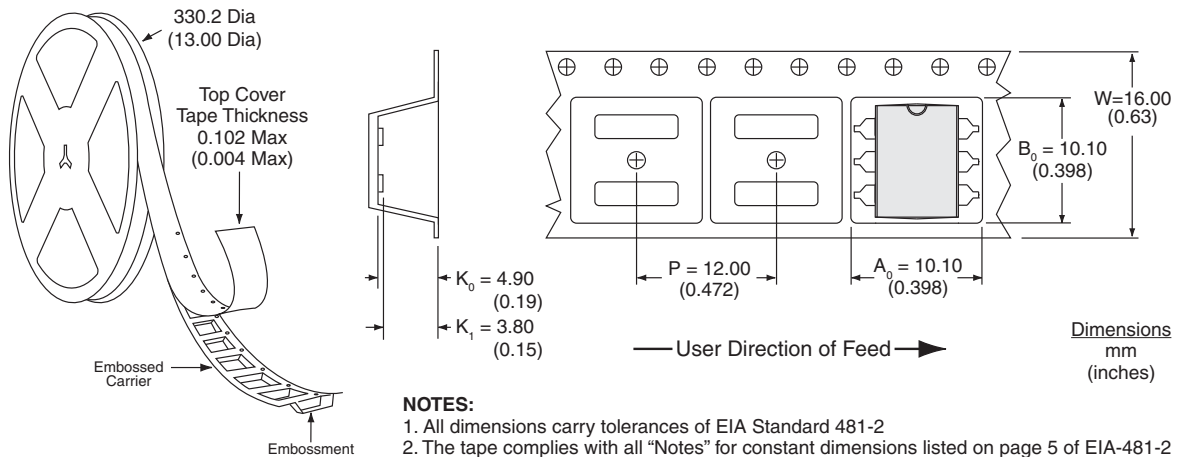

For additional information please visit our website at: [www.ixysic.com](http://www.ixysic.com)

IXYS Integrated Circuits Division makes no representations or warranties with respect to the accuracy or completeness of the contents of this publication and reserves the right to make changes to specifications and product descriptions at any time without notice. Neither circuit patent licenses nor indemnity are expressed or implied. Except as set forth in IXYS Integrated Circuits Division's Standard Terms and Conditions of Sale, IXYS Integrated Circuits Division assumes no liability whatsoever, and disclaims any express or implied warranty, relating to its products including, but not limited to, the implied warranty of merchantability, fitness for a particular purpose, or infringement of any intellectual property right.

The products described in this document are not designed, intended, authorized or warranted for use as components in systems intended for surgical implant into the body, or in other applications intended to support or sustain life, or where malfunction of IXYS Integrated Circuits Division's product may result in direct physical harm, injury, or death to a person or severe property or environmental damage. IXYS Integrated Circuits Division reserves the right to discontinue or make changes to its products at any time without notice.



Компания «ЭлектроПласт» предлагает заключение долгосрочных отношений при поставках импортных электронных компонентов на взаимовыгодных условиях!

Наши преимущества:

- Оперативные поставки широкого спектра электронных компонентов отечественного и импортного производства напрямую от производителей и с крупнейших мировых складов;
- Поставка более 17-ти миллионов наименований электронных компонентов;
- Поставка сложных, дефицитных, либо снятых с производства позиций;
- Оперативные сроки поставки под заказ (от 5 рабочих дней);
- Экспресс доставка в любую точку России;
- Техническая поддержка проекта, помощь в подборе аналогов, поставка прототипов;
- Система менеджмента качества сертифицирована по Международному стандарту ISO 9001;
- Лицензия ФСБ на осуществление работ с использованием сведений, составляющих государственную тайну;
- Поставка специализированных компонентов (Xilinx, Altera, Analog Devices, Intersil, Interpoint, Microsemi, Aeroflex, Peregrine, Syfer, Eurofarad, Texas Instrument, Miteq, Cobham, E2V, MA-COM, Hittite, Mini-Circuits, General Dynamics и др.);

Помимо этого, одним из направлений компании «ЭлектроПласт» является направление «Источники питания». Мы предлагаем Вам помощь Конструкторского отдела:

- Подбор оптимального решения, техническое обоснование при выборе компонента;
- Подбор аналогов;
- Консультации по применению компонента;
- Поставка образцов и прототипов;
- Техническая поддержка проекта;
- Защита от снятия компонента с производства.



#### Как с нами связаться

**Телефон:** 8 (812) 309 58 32 (многоканальный)

**Факс:** 8 (812) 320-02-42

**Электронная почта:** [org@eplast1.ru](mailto:org@eplast1.ru)

**Адрес:** 198099, г. Санкт-Петербург, ул. Калинина, дом 2, корпус 4, литера А.