

HOUSING

FIRST CIRCUIT INDICATOR

FCI PART NUMBER AND DATE CODE

HOLD DOWN SEE NOTES 8

SIGNAL CONTACT POWER CONTACTS



25Sx10P CONFIGURATION SHOWN  
HOLD DOWN TYPE

SCREW MOUNT SEE NOTES 9

25Sx10P CONFIGURATION SHOWN  
SCREW MOUNT TYPE

NOTES:

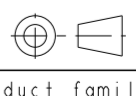
- HOUSING MATERIAL: GF LCP, COLOR: BLACK, UL 94 V-0 RATED  
SIGNAL CONTACT MATERIAL: PHOSPHOR BRONZE  
SIGNAL PIN OVERMOLD MATERIAL: GF POLYESTER  
POWER CONTACT MATERIAL: COPPER ALLOY
- PLATING ON SIGNAL CONTACTS: 1.27µm MIN Ni UNDERPLATING ALL OVER WITH 0.76µm MIN GXT IN CONTACT MATING AREA, AND 0.5µm MIN MATTE TIN ON TAIL AREA.  
  
PLATING ON POWER CONTACTS: 1.27µm MIN Ni UNDERPLATING ALL OVER WITH 0.76µm MIN GXT IN CONTACT MATING AREA, AND 0.5µm MIN MATTE TIN ON TAIL AREA.  
  
PLATING ON HOLD DOWN IF APPLICABLE: 1.27µm MIN Ni, UNDERPLATING ALL OVER WITH 0.76µm MIN MATTE TIN OVER.
- LUBRICATION: LUBRICATE ON CONTACT AREA.
- RECOMMENDED PCB THICKNESS IS:  
FOR PRESS FIT APPLICATION: 1.4mm MIN  
FOR SOLDER APPLICATION: 1.40mm THROUGH 2.62mm.
- FOR SCREW MOUNT APPLICATIONS, A #4-40 UNC PAN SCREW WITH HEX NUT IS RECOMMENDED (SUPPLIED BY CUSTOMER).
- FOR PRESS FIT  $\varnothing 0.61 \pm 0.05\text{mm}$ , FOR SOLDER  $\varnothing 0.90 \pm 0.05\text{mm}$ .
- UNPLATED HOLES.
- HOLD DOWN APPLICATION NEEDED.
- SCREW MOUNT APPLICATION NEEDED.
- PRODUCT SPECIFICATION: GS-12-1064  
APPLICATION SPECIFICATION: GS-20-0362

spec ref	SEE NOTE 10	dr	Zhang Hong-Tu	2012/08/13	projection	MM	size	A2	scale	1:1	
tolerance std	TOLERANCES UNLESS OTHERWISE SPECIFIED	eng	De-Ming Lu	2017/05/09			ecn no	ELX-DG-18076-1			
ISO 406		chr	Fancy Zhang	2017/05/23			rel level	Released			
ISO 1101		appr	Pei-Ming Zheng	2017/05/26			product family	PwrLoPro			
surface	linear	0.X	±0.30		PWR LoPro HEADER ASSEMBLY		dwg no	10122460		rev	H
		0.XX	±0.20		RA, PASSIVE GUIDE,S+P						
		0.XXX	±0.10		cat. no.	-	Product - Customer Drw	sheet 1 of 10			
ISO 1302	angular	0°	±2°								

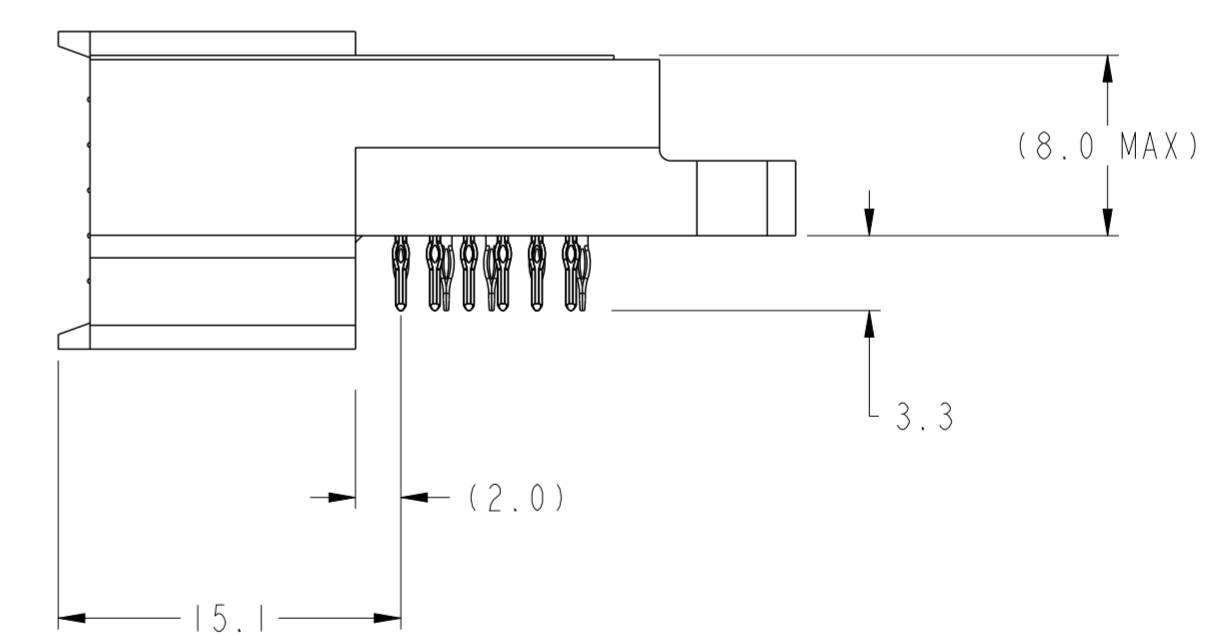
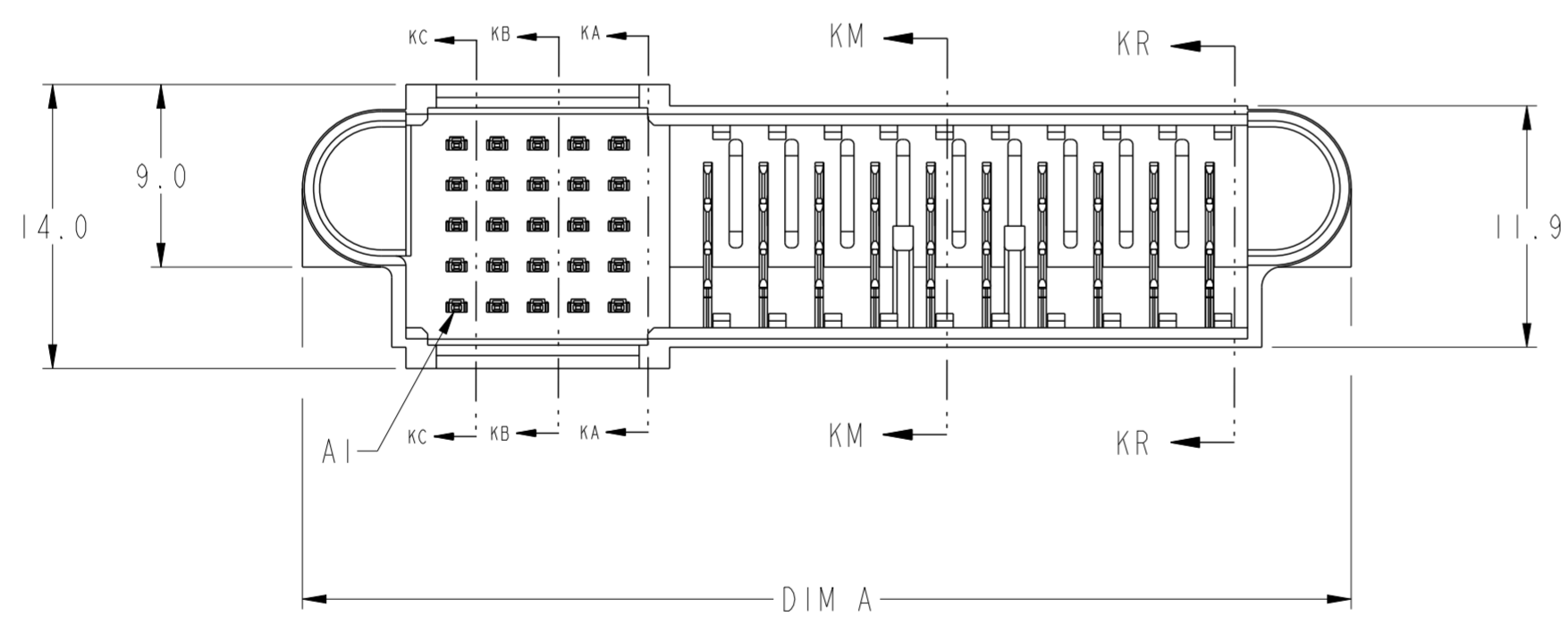
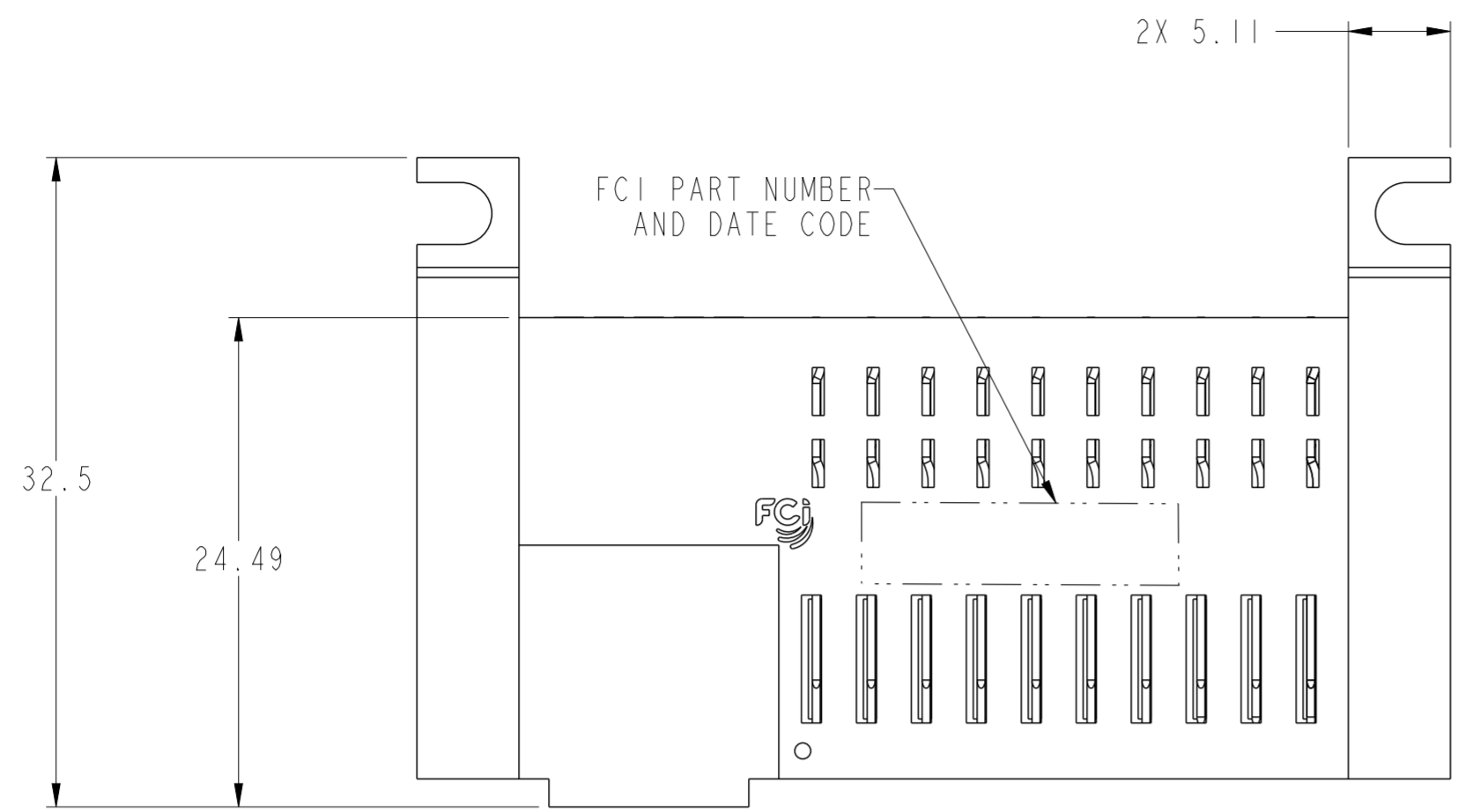

SCREW MOUNT TYPE AS SHOWN

spec ref	SEE NOTE 10	dr	Zhang Hong-Tu	2012/08/13	projection	MM	size	A2	scale	3:1
tolerance std	ISO 406 ISO 1101	eng	De-Ming Lu	2017/05/09			ecn no	ELX-DG-18076-1		
surface	TOLERANCES UNLESS OTHERWISE SPECIFIED linear 0.X ±0.30 0.XX ±0.20 0.XXX ±0.10 angular 0° ±2°	chr	Fancy Zhang	2017/05/23			rel level	Released		
ISO 1302		appr	Pai-Ming Zheng	2017/05/26			product family	PwrLoPro		
		<b>Amphenol FCI</b>			title PWR LoPro HEADER ASSEMBLY RA, PASSIVE GUIDE,S+P		dwg no 10122460	rev H	Product - Customer Drw sheet 2 of 10	

PDS: Rev :H

STATUS:Released

Printed: May 26, 2017

Amphenol FCI

© 2016 APCI

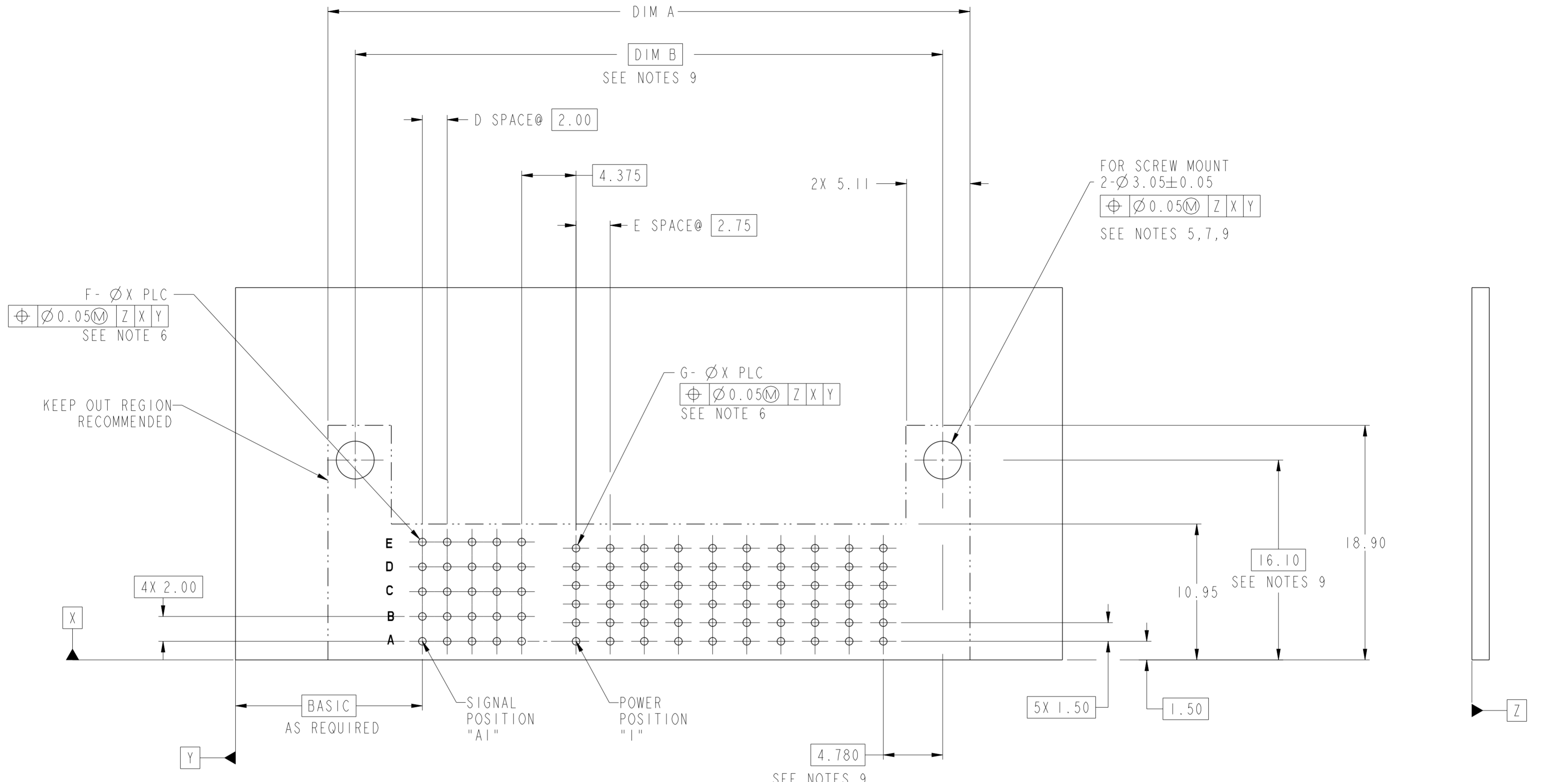

10122460-002LF AS SHOWN  
 RECOMMENDED PRINTED CIRCUIT BOARD LAYOUT SEE NOTE 4  
 FOR 10122460-XXXLF SCREW MOUNT TYPE  
 (AS VIEWED FROM COMPONENT SIDE)

spec ref	SEE NOTE 10	dr	Zhang Hong-Tu	2012/08/13	projection	MM	size	A2	scale	3:1
tolerance std	ISO 406 ISO 1101	eng	De-Ming Lu	2017/05/09		MM	ecn no	ELX-DG-18076-1	rel level	Released
TOLERANCES UNLESS OTHERWISE SPECIFIED		chr	Fancy Zhang	2017/05/23						
		appr	Pei-Ming Zheng	2017/05/26						
surface	linear	0.X	$\pm 0.30$		product family		PwrLoPro	title PWR LoPro HEADER ASSEMBLY RA, PASSIVE GUIDE,S+P	dwg no 10122460	rev H
		0.XX	$\pm 0.20$		cat. no.		-			
	angular	0°	$\pm 2^\circ$		Product - Customer Drw		sheet 3 of 10			

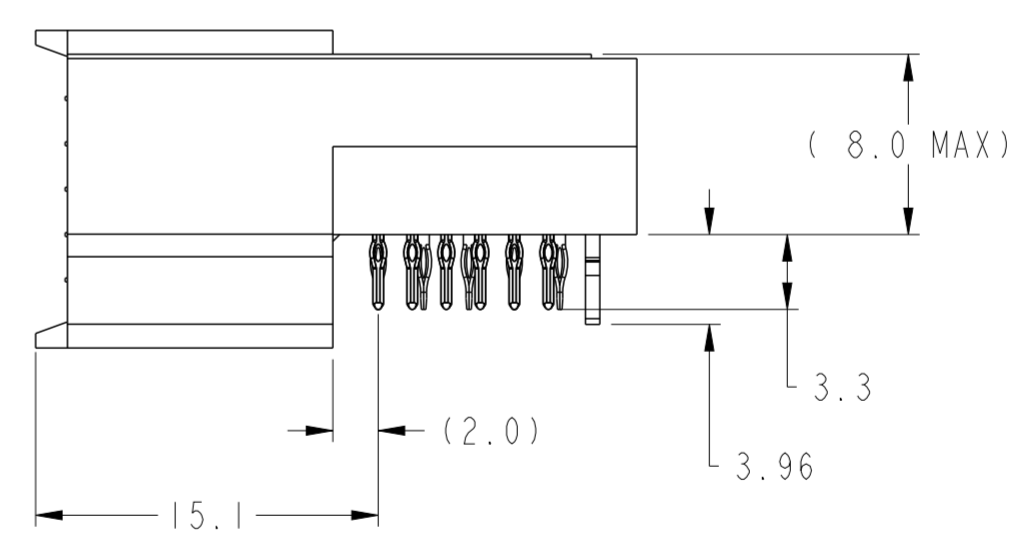
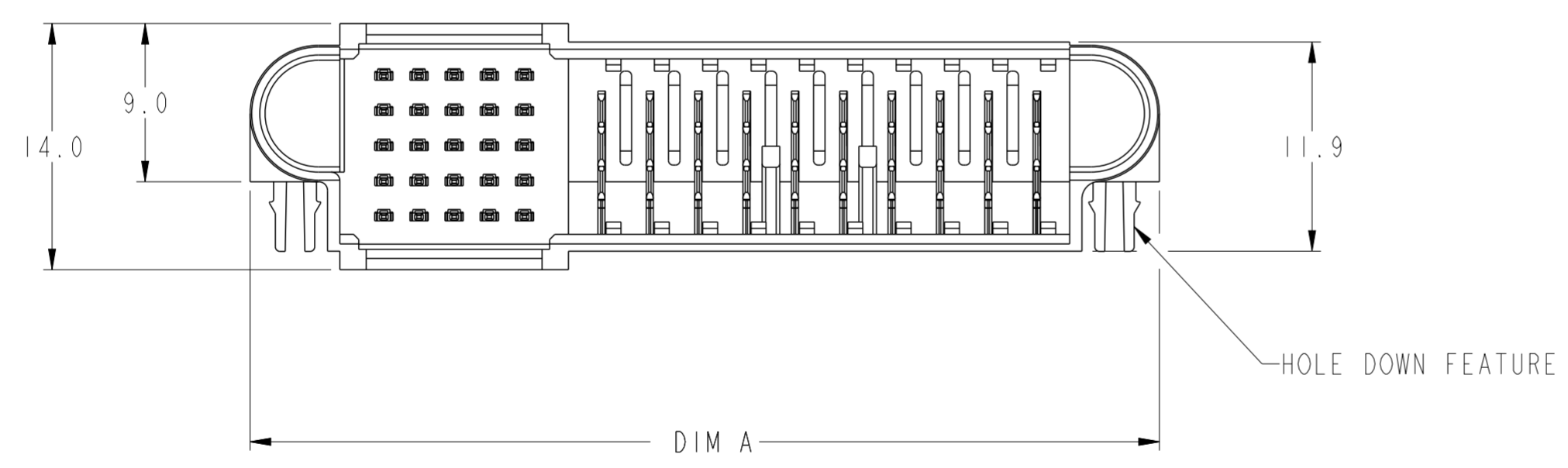
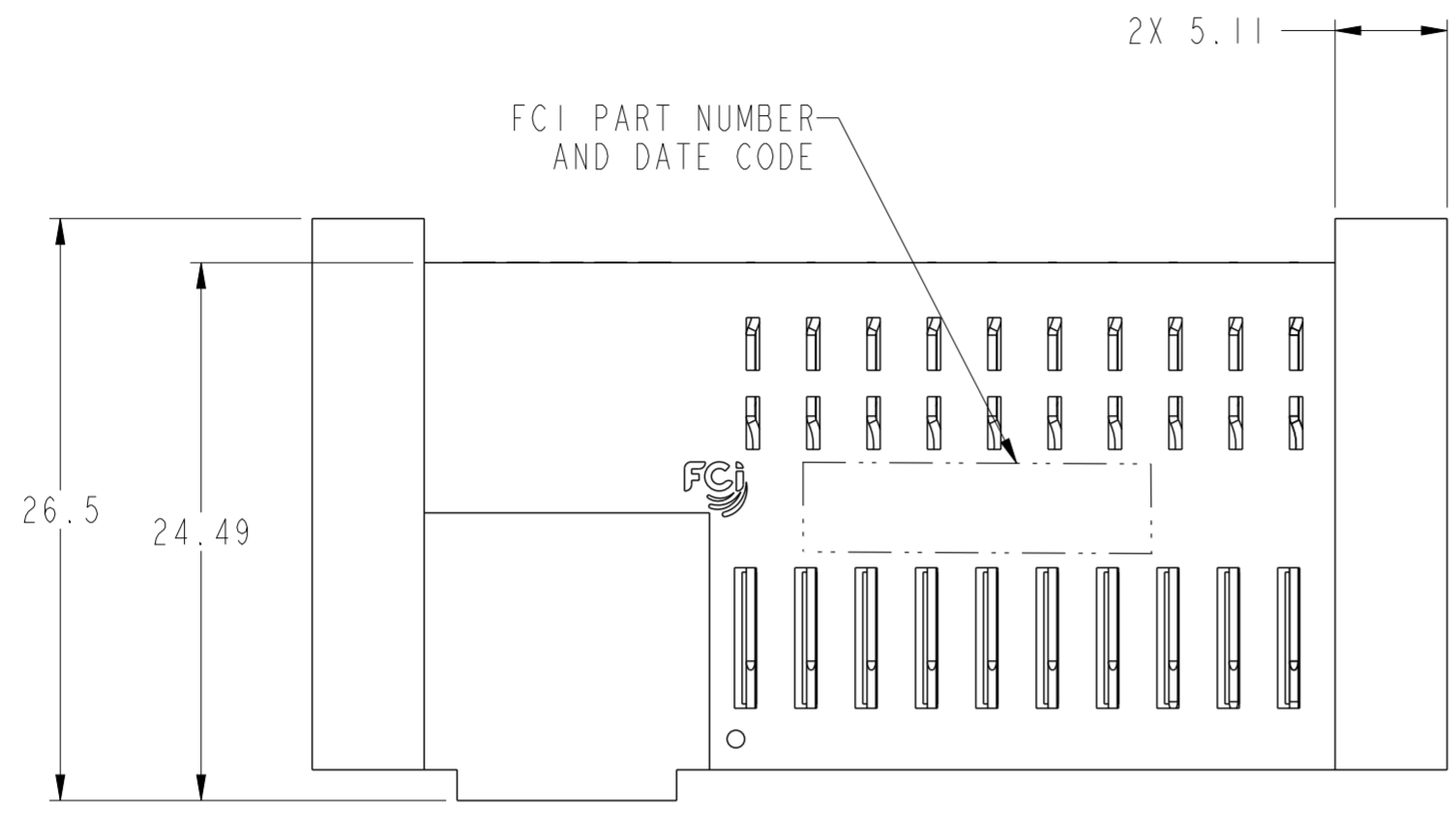

HOLE DOWN TYPE AS SHOWN

spec ref	SEE NOTE 10	dr	Zhang Hong-Tu	2012/08/13	projection	MM	size	A2	scale	3:1
tolerance std	TOLERANCES UNLESS OTHERWISE SPECIFIED	eng	De-Ming Lu	2017/05/09			ecn no	ELX-DG-18076-1	rel level	Released
ISO 406 ISO 1101		chr	Fancy Zhang	2017/05/23						
surface	linear 0.X ±0.30 0.XX ±0.20 0.XXX ±0.10 angular 0° ±2°	appr	Pei-Ming Zheng	2017/05/26	product family	PwrLoPro	rel level	Released	rev	H
ISO 1302		Amphenol FCi	PWR LoPro HEADER ASSEMBLY		cat. no.	-	Product - Customer Drw	sheet 4 of 10		

PDS: Rev :H

STATUS:Released

Printed: May 26, 2017

Amphenol  
FCi

© 2016 AFci

Amphenol  
FCi

© 2016 AFci

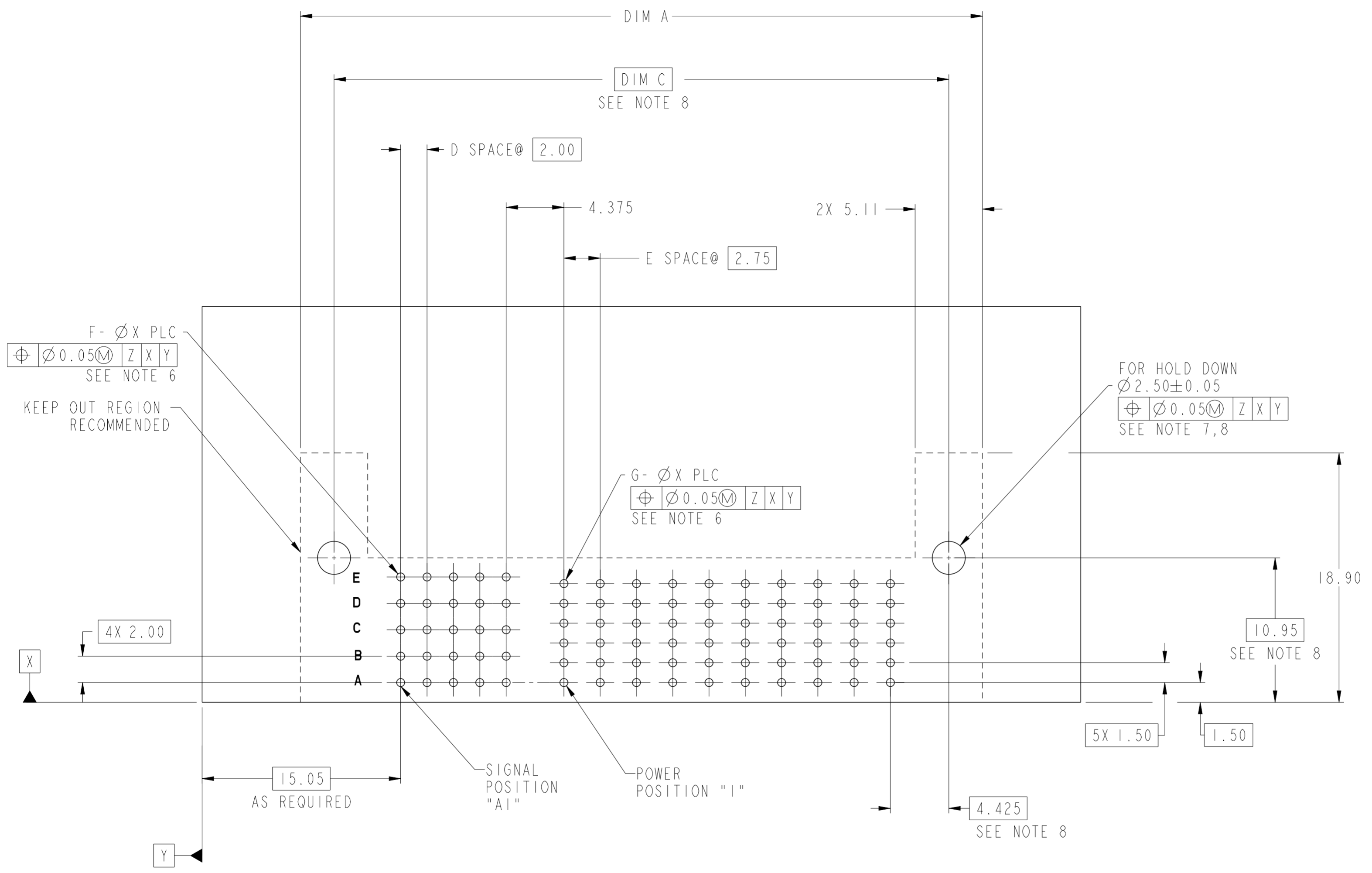

10122460-003LF AS SHOWN  
 RECOMMENDED PRINTED CIRCUIT BOARD LAYOUT SEE NOTE 4  
 FOR 10122460-XXXLF HOLD DOWN TYPE  
 (AS VIEWED FROM COMPONENT SIDE)

spec ref	SEE NOTE 10	dr	Zhang Hong-Tu	2012/08/13	projection	MM	size	A2	scale	4:1
tolerance std	ISO 406 ISO 1101	eng	De-Ming Lu	2017/05/09		MM	ecn no	ELX-DG-18076-1	rel level	Released
surface	linear	0.X	±0.30							
		0.XX	±0.20							
	angular	0°	±2°	0.XXX	±0.10	product family	PwrLoPro	rel level	Released	
		Amphenol FCi	PWR LoPro HEADER ASSEMBLY		RA, PASSIVE GUIDE,S+P	cat. no.	10122460	rev	H	
							Product - Customer Drw	sheet 5 of 10		

PDS: Rev :H

STATUS:Released

Printed: May 26, 2017

PART NUMBER	CONFIGURATION	DIM "A"	DIM "B" FOR SCREW MOUNT	DIM "C" FOR HOLD DOWN	"D" SPACES	"E" SPACES	"F" QTY.	"G" QTY.	MOUNTING FEATURE
10122460-001LF	35S+18P	77.71	-	72.60	6	17	35	108	HOLD DOWN
10122460-003LF	25S+10P	51.71	-	46.6	4	9	25	60	HOLD DOWN
10122460-004LF	25S+8P	46.21	-	41.1	4	7	25	48	HOLD DOWN
10122460-005LF	25S+10P	51.71	-	46.6	4	9	25	60	HOLD DOWN
10122460-006LF	25S+8P	46.21	-	41.1	4	7	25	48	HOLD DOWN
10122460-007LF	25S+10P	51.71	47.31	-	4	9	25	60	SCREW MOUNT
10122460-008LF	15S+2P	25.71	-	15.1	2	1	15	12	HOLD DOWN
10122460-009LF	25S+10P	51.71	-	46.6	4	9	25	60	HOLD DOWN
10122460-010LF	35S+20P	83.21	-	78.1	6	19	35	120	HOLD DOWN
10122460-011LF	25S+02P	29.71	-	24.6	4	1	25	12	HOLD DOWN
10122460-013LF	25S+10P	51.71	47.31	-	4	9	25	60	SCREW MOUNT

Amphenol  
FCI

© 2016 AFCI

spec ref	SEE NOTE 10	dr	Zhang Hong-Tu	2012/08/13	projection	MM	size	A2	scale	3:1
tolerance std	TOLERANCES UNLESS OTHERWISE SPECIFIED	eng	De-Ming Lu	2017/05/09		←	ecn no	ELX-DG-18076-1		
ISO 406		chr	Fancy Zhang	2017/05/23			rel level	Released		
ISO 1101		appr	Pai-Ming Zheng	2017/05/26			product family	PwrLoPro		
surface	linear	0.X	±0.30	Amphenol FCI	PWR LoPro HEADER ASSEMBLY	RA, PASSIVE GUIDE,S+P	div no	10122460	rev	H
ISO 1302	0.XX	±0.20								
	0.XXX	±0.10								
angular	0°	±2°	cat. no.	-	Product - Customer Drw	sheet 6 of 10				

PDS: Rev :H

STATUS:Released

Printed: May 26, 2017

CUSTOMER LOADING WORKSHEET FOR SIGNAL & POWER SEQUENCING LEVELS

PWR LO PRO - MATING FACE OF HEADER CONNECTOR(4)

E																																		
D																																		
C																																		
B																																		
A																																		
ROWS	MOUNTING FEATURE(3)	1	2	3	4	5	6	7	8	1	2	3	4	5	6	7	8	9	10	11	12	13	14	15	16	17	18	19	20	21	22	23	24	MOUNTING FEATURE(3)
		SIGNAL CONTACTS(2)								POWER CONTACTS(1)																								

- 1). LOAD WITH CHOICE OF 2 POWER CONTACT MATING LEVELS, SEE SECTIONS KM & KR FOR AVAILABLE LEVEL OPTIONS.
- 2). LOAD WITH CHOICE OF 3 SIGNAL CONTACT MATING LEVELS, SEE SECTIONS KA,KB,&KC FOR AVAILABLE LEVEL OPTIONS.
- 3). MOUNTING FEATURE OPTION "X"  
 - H : HOLD DOWN TYPE  
 - S : SCREW MOUNT TYPE
- 4). CUSTOMER LOADING WORKSHEET SHOWN AT MAXMUM SIZE CONFIGURATION (40Sx24P), SIGNALS AVAILABLE IN 2,3,4 THRU 8 POSITIONS, POWERS AVAILABLE IN 4,6,8 THRU 24 POSITIONS IN EVEN QUANTITIES ONLY.

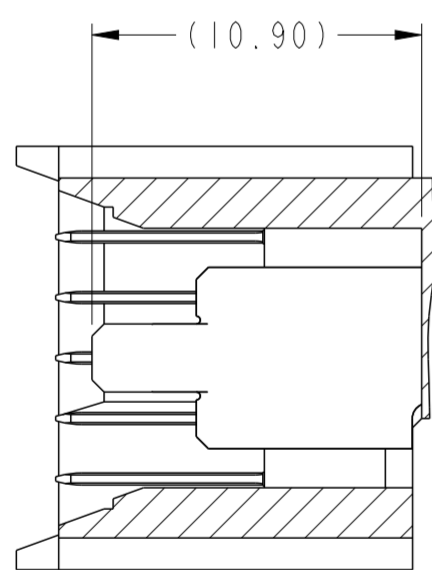

POWER SECTION KM-KM LEVEL 1: LONGEST MATING CONTACTS

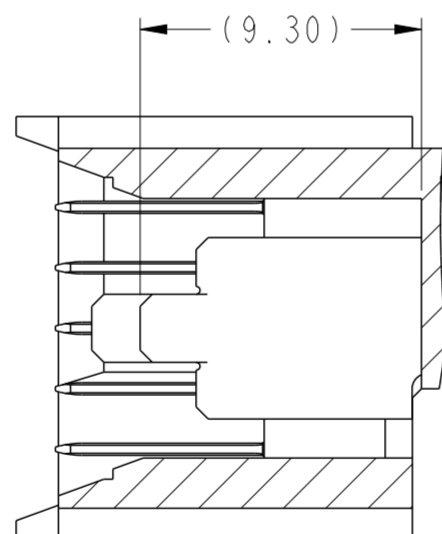

POWER SECTION KR-KR LEVEL 2: SHORTEST MATING CONTACTS

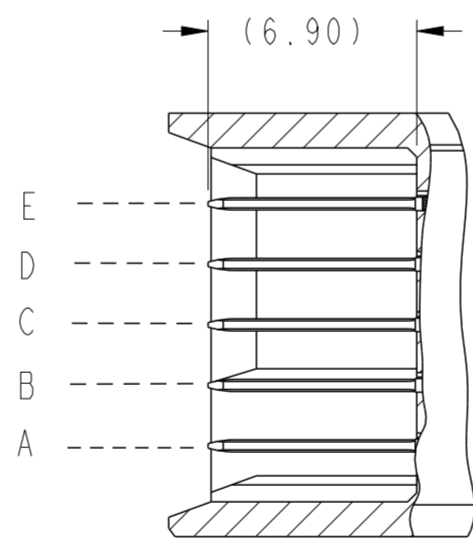

SIGNAL SECTION KA-KA LEVEL 2: ALL LONGEST CONTACTS

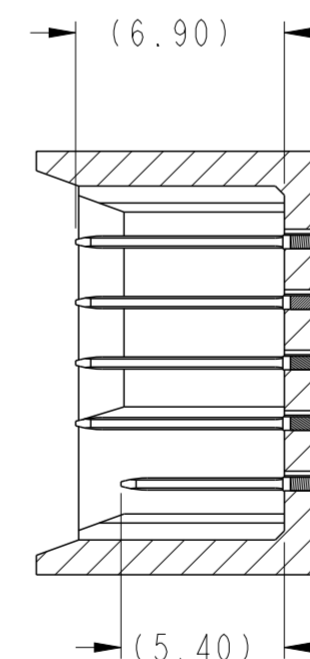

SIGNAL SECTION KB-KB LEVEL 32222 (MIXED): ROW "A", SHORTEST CONTACT ROW "B" THRU "E", LONGEST CONTACTS

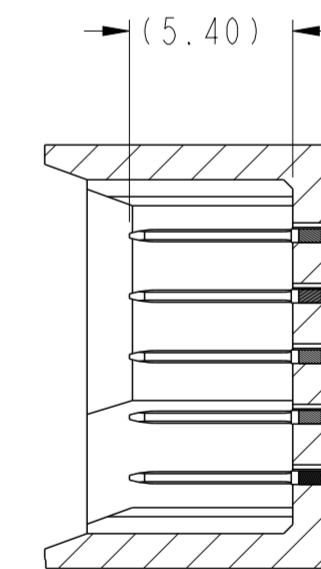

SIGNAL SECTION KC-KC LEVEL 3: ALL SHORTEST CONTACTS

Amphenol FCI

© 2016 AFCI

spec ref	SEE NOTE 10	dr	Zhang Hong-Tu	2012/08/13	projection	MM	size	A2	scale	1:1					
tolerance std	ISO 406 ISO 1101	eng	De-Ming Lu	2017/05/09			ecn no	ELX-DG-18076-1	rel level	Released					
surface	linear	0.X	±0.30	Amphenol FCI							PWR LoPro HEADER ASSEMBLY	cat. no.	-	Product - Customer Drw	sheet 7 of 10
		0.XX	±0.20												
	angular	0°	±2°												

PDS: Rev :H

STATUS:Released

Printed: May 26, 2017

PART NUMBER	ROWS	SIGNALS							POWERS																	
		1	2	3	4	5	6	7	1	2	3	4	5	6	7	8	9	10	11	12	13	14	15	16	17	18
10122460-001LF 35S + 18P	E																									
	D																									
	C																									
	B																									
	A																									

PART NUMBER	ROWS	SIGNALS					POWERS																		
		1	2	3	4	5	1	2	3	4	5	6	7	8	9	10									
10122460-003LF 25S + 10P	E																								
	D																								
	C																								
	B																								
	A																								

PART NUMBER	ROWS	SIGNALS					POWERS																		
		1	2	3	4	5	1	2	3	4	5	6	7	8											
10122460-004LF 25S + 8P	E																								
	D																								
	C																								
	B																								
	A																								

PART NUMBER	ROWS	SIGNALS					POWERS																		
		1	2	3	4	5	1	2	3	4	5	6	7	8	9	10									
10122460-005LF 25S + 10P	E																								
	D																								
	C																								
	B																								
	A																								

VIEWED FROM MATING FACE:

Amphenol  
FCi

© 2016 AFCI

spec ref	SEE NOTE 10	dr	Zhang Hong-Tu	2012/08/13	projection	MM	size	A2	scale	1:1
tolerance std	TOLERANCES UNLESS OTHERWISE SPECIFIED	eng	De-Ming Lu	2017/05/09		←	ecn no	ELX-DG-18076-1	rel level	Released
ISO 406		chr	Fancy Zhang	2017/05/23						
ISO 1101		appr	Pei-Ming Zheng	2017/05/26						
surface	linear	0.X	±0.30	Amphenol FCi	PWR LoPro HEADER ASSEMBLY	RA, PASSIVE GUIDE,S+P	dvw no	10122460	rev	H
ISO 1302	0.XX	±0.20								
	0.XXX	±0.10								
angular	0°	±2°	cat. no.	-	Product - Customer Drw	sheet 8 of 10				

PDS: Rev :H

STATUS:Released

Printed: May 26, 2017





PART NUMBER	ROWS	SIGNALS					POWERS									
		1	2	3	4	5	1	2	3	4	5	6	7	8		
10122460-006LF 25S + 8P	E	H	2	2	32222	2	2	-	-	2	2	2	2	2	-	H
	D															
	C															
	B															
	A															

PART NUMBER	ROWS	SIGNALS					POWERS											
		1	2	3	4	5	1	2	3	4	5	6	7	8	9	10		
10122460-007LF 25S + 10P	E	S	2	2	2	2	3	2	2	2	2	2	2	2	2	2	2	S
	D																	
	C																	
	B																	
	A																	

PART NUMBER	ROWS	SIGNALS			POWERS			
		1	2	3	1	2		
10122460-008LF 15S + 2P	E	H	32222	2	2	-	2	H
	D							
	C							
	B							
	A							

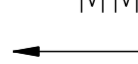
PART NUMBER	ROWS	SIGNALS					POWERS											
		1	2	3	4	5	1	2	3	4	5	6	7	8	9	10		
10122460-009LF 25S + 10P	E	H	2	2	3	2	2	2	2	2	2	2	2	2	2	2	2	H
	D																	
	C																	
	B																	
	A																	

spec ref	SEE NOTE 10	dr	Zhang Hong-Tu	2012/08/13	projection	MM	size	A2	scale	1:1
tolerance std	TOLERANCES UNLESS OTHERWISE SPECIFIED	eng	De-Ming Lu	2017/05/09			ecn no	ELX-DG-18076-1	rel level	Released
ISO 406		chr	Fancy Zhang	2017/05/23						
ISO 1101		appr	Pei-Ming Zheng	2017/05/26						
surface	linear	0.X	±0.30		title PWR LoPro HEADER ASSEMBLY RA, PASSIVE GUIDE,S+P	dwg no 10122460	rev H	cat. no. -	Product - Customer Drw	sheet 9 of 10
ISO 1302	0.XXX	±0.20								
	angular	0°	±2°							

Amphenol FCI

© 2016 AFCI

PART NUMBER	ROWS	SIGNALS							POWERS																			
		1	2	3	4	5	6	7	1	2	3	4	5	6	7	8	9	10	11	12	13	14	15	16	17	18	19	20
10122460-010LF 35S + 20P	E																											
	D																											
	C	3	3	3	3	3	3	3	2	2	2	-	-	-	-	-	-	-	-	2	2	2	2	2	2	2	2	
	B																											
	A																											

PART NUMBER	ROWS	SIGNALS					POWERS	
		1	2	3	4	5	1	2
10122460-011LF 25S + 02P	E							
	D							
	C	2	32222	2	32222	2	1	2
	B							
	A							

PART NUMBER	ROWS	SIGNALS					POWERS										
		1	2	3	4	5	1	2	3	4	5	6	7	8	9	10	
10122460-013LF 25S + 10P	E																
	D																
	C	2	2	2	2	3	2	2	2	2	2	2	2	2	2	2	
	B																
	A																

CODE	DESCRIPTION
1	FOR LEVEL 1
2	FOR LEVEL 2
32222	FOR LEVEL 32222 (MIXED)
3	FOR LEVEL 3

Amphenol  
FCi

© 2016 AFci

spec ref	SEE NOTE 10	dr	Zhang Hong-Tu	2012/08/13	projection	MM	size	A2	scale	1:1		
tolerance std	TOLERANCES UNLESS OTHERWISE SPECIFIED	eng	De-Ming Lu	2017/05/09		MM	A2	1:1	ecn no	ELX-DG-18076-1		
ISO 406		chr	Fancy Zhang	2017/05/23						rel level	Released	
ISO 1101		appr	Pei-Ming Zheng	2017/05/26						product family	PwrLoPro	
surface	linear	0.X	±0.30	<b>Amphenol FCi</b>	PWR LoPro HEADER ASSEMBLY	RA, PASSIVE GUIDE,S+P	10122460	rev	H			
ISO 1302	0.XX	±0.20	cat. no.							-	Product - Customer Drw	sheet 10 of 10
	0.XXX	±0.10										
angular	0°	±2°	PDS: Rev :H		STATUS:Released		Printed: May 26, 2017					



Компания «ЭлектроПласт» предлагает заключение долгосрочных отношений при поставках импортных электронных компонентов на взаимовыгодных условиях!

Наши преимущества:

- Оперативные поставки широкого спектра электронных компонентов отечественного и импортного производства напрямую от производителей и с крупнейших мировых складов;
- Поставка более 17-ти миллионов наименований электронных компонентов;
- Поставка сложных, дефицитных, либо снятых с производства позиций;
- Оперативные сроки поставки под заказ (от 5 рабочих дней);
- Экспресс доставка в любую точку России;
- Техническая поддержка проекта, помощь в подборе аналогов, поставка прототипов;
- Система менеджмента качества сертифицирована по Международному стандарту ISO 9001;
- Лицензия ФСБ на осуществление работ с использованием сведений, составляющих государственную тайну;
- Поставка специализированных компонентов (Xilinx, Altera, Analog Devices, Intersil, Interpoint, Microsemi, Aeroflex, Peregrine, Syfer, Eurofarad, Texas Instrument, Miteq, Cobham, E2V, MA-COM, Hittite, Mini-Circuits, General Dynamics и др.);

Помимо этого, одним из направлений компании «ЭлектроПласт» является направление «Источники питания». Мы предлагаем Вам помощь Конструкторского отдела:

- Подбор оптимального решения, техническое обоснование при выборе компонента;
- Подбор аналогов;
- Консультации по применению компонента;
- Поставка образцов и прототипов;
- Техническая поддержка проекта;
- Защита от снятия компонента с производства.



#### Как с нами связаться

**Телефон:** 8 (812) 309 58 32 (многоканальный)

**Факс:** 8 (812) 320-02-42

**Электронная почта:** [org@eplast1.ru](mailto:org@eplast1.ru)

**Адрес:** 198099, г. Санкт-Петербург, ул. Калинина, дом 2, корпус 4, литера А.