

Click [here](#) for production status of specific part numbers.

MAX40016

4-Decade Current Sense Amplifier with Integrated Current Sense Element

General Description

The MAX40016 is a very wide range current sense amplifier (CSA) with internal sense element that senses from less than 300 μ A to greater than 3A current range. The 4-decade sensed current functions with 1% (typical) gain error and offers three, multiplexed programmable output ranges in order to interface with 12-bit ADCs. Having an integrated sense element has the extra advantage that the entire current measuring path can be factory-trimmed, saving the user from having to calibrate independent sense resistors and CSAs. The MAX40016 (WLP package) drops a typical of 60mV at 3A from the voltage input to load output.

The MAX40016's integrated current-sensing element saves the space and cost of an external high-power, precision current sense resistor. The MAX40016 is offered in an ultra-tiny, 1.98mm x 1.31mm, 15-bump wafer-level package (WLP), further reducing board space. The MAX40016 is also available in a 4mm x 4mm 16-pin TQFN package.

The MAX40016 operates with a supply voltage from 2.5V to 5.5V. The device features a low-power mode in which the current-sensing element remains on, but the outputs are turned off to reduce the total supply current below 10 μ A (max).

The MAX40016 also includes a committed on-board amplifier with an internal gain of 1.5V/V. The MAX40016 operates over the -40°C to +125°C temperature range.

Applications

- Mobile Devices
- RF Power Monitoring
- Portable Instruments

Benefits and Features

- Integrated Current Sense Element Saves The Space and Cost of Expensive Precision Sense Resistors
- 4-Decade Measurement Range
 - Maintains Accuracy from < 300 μ A to > 3A
- Withstands Overloads to 4A
- Low Voltage Drop Across Sense Element
 - 60mV (Active Mode, 3A Load, WLP Package)
 - 35mV (Low Power Mode, 3A Load, WLP Package)
- Three Multiplexed Scaling Resistor Outputs Allow Full Dynamic Range while Interfaced to 12-bit ADCs
- +2.5V to +5.5V Input Supply Voltage Range
- Low Power Mode Reduces Supply Current to 10 μ A Max
- Space-Saving
 - Tiny 1.98mm x 1.3mm, 15-Bump WLP
 - 4mm x 4mm 16-Pin TQFN
- -40°C to +125°C Operating Temperature Range

[Ordering Information](#) appears at end of data sheet.

Simplified Block Diagram

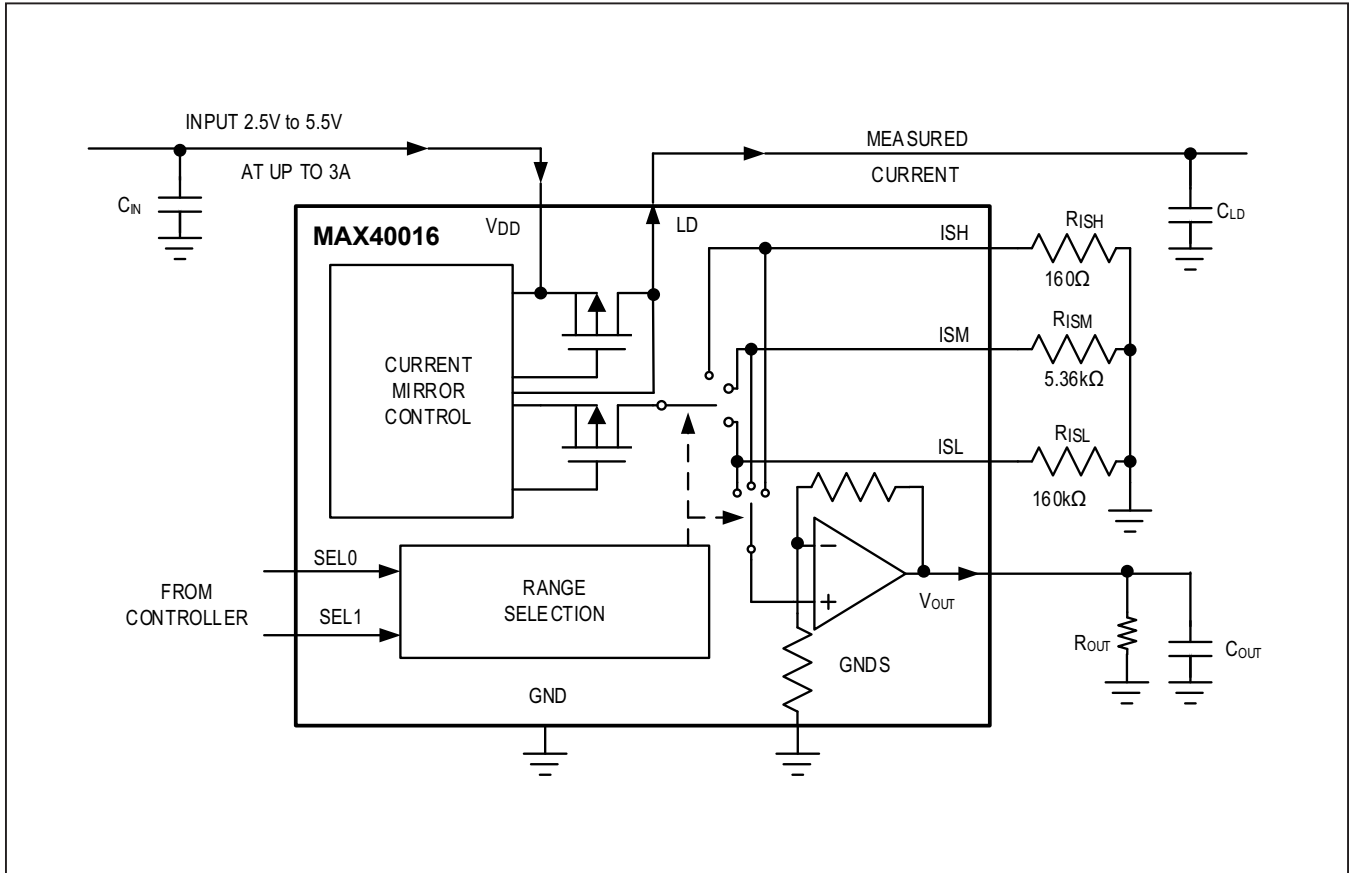

Absolute Maximum Ratings

V _{DD} to GND	-0.3V to +6V	Continuous Power Dissipation (T _A = +70°C)
GND to GNDS	-0.3V to +0.3V	15-Bump WLP (derate 14.39mW/°C above +70°C)
SEL0, SEL1, ISL, ISM, ISH, V _{OUT} to GND	-0.3V to V _{DD} +0.3V	16-Pin TQFN (derate 25mW/°C above +70°C)
V _{DD} to LD	-0.3V to 0.3V	Operating Temperature Range
LD to GND	V _{DD} - 0.3V to V _{DD} + 0.3V	Junction Temperature
Maximum Current		Storage Temperature Range
(All pins except V _{DD} , LD, continuous).....	20mA	Soldering Temperature (reflow)
Current from V _{DD} to LD (Continuous).....	4A	

Stresses beyond those listed under "Absolute Maximum Ratings" may cause permanent damage to the device. These are stress ratings only, and functional operation of the device at these or any other conditions beyond those indicated in the operational sections of the specifications is not implied. Exposure to absolute maximum rating conditions for extended periods may affect device reliability.

Package Information

15 WLP

PACKAGE CODE	N151B1+1
Outline Number	21-100213
Land Pattern Number	Refer to Application Note 1891
THERMAL RESISTANCE, MULTI-LAYER BOARD:	
Junction to Ambient (θ _{JA})	69.5°C/W
Junction to Case (θ _{JC})	N/A

16 TQFN

PACKAGE CODE	T1644+4
Outline Number	21-0139
Land Pattern Number	90-0070
THERMAL RESISTANCE, MULTI-LAYER BOARD:	
Junction to Ambient (θ _{JA})	40°C/W
Junction to Case (θ _{JC})	6°C/W

For the latest package outline information and land patterns (footprints), go to www.maximintegrated.com/packages. Note that a "+", "#", or "-" in the package code indicates RoHS status only. Package drawings may show a different suffix character, but the drawing pertains to the package regardless of RoHS status.

Package thermal resistances were obtained using the method described in JEDEC specification JESD51-7, using a four-layer board. For detailed information on package thermal considerations, refer to www.maximintegrated.com/thermal-tutorial.

Electrical Characteristics

(V_{DD} = 3.6V, I_{LD} = 300mA, C_{LD} = 10µF, SEL0 = V_{DD}, SEL1 = V_{DD} (ISH range is selected), T_A = T_{MIN} to T_{MAX}, unless otherwise noted. Typical values are at T_A = +25°C (Note 1))

PARAMETER	SYMBOL	CONDITIONS	MIN	TYP	MAX	UNITS
CURRENT SENSING						
Supply Voltage	V _{DD}	Guaranteed by PSRR	2.5		5.5	V
Supply Current (Active)	I _{DD}	No I _{LD} current, V _{ISX} = 0V		0.8	1.2	mA
Supply Current (Low-Power Mode)	I _{DD_LP}	Low-power mode (SEL0 = 0V, SEL1 = 0V), no I _{LD} current, V _{ISX} = 0V		5	10	µA
Power-Up Time		Measure at 50% of V _{OUT} .		100		µs
Power Supply Rejection Ratio	PSRR	ΔGain Error/ΔV _{DD} , measured at ISX (Note 2)	-0.6	+0.2	+0.6	%/V

Electrical Characteristics (continued)

(V_{DD} = 3.6V, I_{LD} = 300mA, C_{LD} = 10μF, SEL0 = V_{DD}, SEL1 = V_{DD} (ISH range is selected), T_A = T_{MIN} to T_{MAX}, unless otherwise noted. Typical values are at T_A = +25°C (Note 1))

PARAMETER	SYMBOL	CONDITIONS	MIN	TYP	MAX	UNITS	
Voltage Drop (V _{DD} to LD) (WLP)		Active mode, I _{LD} = 3A (Note 6)	-40°C < T _A < +85°C	60	90	mV	
			-40°C < T _A < +125°C		100		
		Active mode, I _{LD} = 2A	-40°C < T _A < +85°C	50	80		
			-40°C < T _A < +125°C		95		
		Low power mode, I _{LD} = 3A (Note 6)	-40°C < T _A < +85°C	35	50		
			-40°C < T _A < +125°C		55		
Low power mode, I _{LD} = 2A	-40°C < T _A < +85°C	23	35				
	-40°C < T _A < +125°C		35				
Voltage Drop (V _{DD} to LD) (TQFN)		Active mode, I _{LD} = 3A (Note 6)	-40°C < T _A < +85°C	160	230	mV	
			-40°C < T _A < +125°C	160	250		
		Active mode, I _{LD} = 2A	-40°C < T _A < +85°C	120	180		
			-40°C < T _A < +125°C	120	200		
		Low power mode, I _{LD} = 3A (Note 6)	-40°C < T _A < +85°C	150	220		
			-40°C < T _A < +125°C	150	230		
Low power mode, I _{LD} = 2A	-40°C < T _A < +85°C	100	150				
	-40°C < T _A < +125°C	100	160				
Current Gain	G _I	I _{ISX} /I _{LD} , measured at ISX		2		mA/A	
Current Gain Error	G _{I_ERR}	R _{ISX} = 160Ω, I _{LD} = 3A (Note 6)	-40°C < T _A < +85°C	-4	+0.9	+4	%
			-40°C < T _A < +125°C	-4	+0.9	+4	
		R _{ISX} = 160Ω, I _{LD} = 300mA	-40°C < T _A < +85°C	-3.5	+0.9	+3.5	
			-40°C < T _A < +125°C	-4		+4	
		R _{ISX} = 5.36kΩ, I _{LD} = 30mA	-40°C < T _A < +85°C	-3.5	+0.7	+3.5	
			-40°C < T _A < +125°C	-4		+4	
		R _{ISX} = 160kΩ, I _{LD} = 3mA	-40°C < T _A < +85°C	-6	+1.4	+6	
			-40°C < T _A < +125°C	-7		+7	
R _{ISX} = 160kΩ, I _{LD} = 1mA	-40°C < T _A < +85°C	-12	+1.7	+12			
	-40°C < T _A < +125°C	-15		+15			
R _{ISX} = 160kΩ, I _{LD} = 300μA	-40°C < T _A < +85°C	-25	+2.8	+25			
	-40°C < T _A < +125°C	-30		+30			
Nonlinearity Current Gain Error	G _{I_ERR(NON)}	Measured at ISX	R _{ISX} = 160Ω, I _{LD} = 30mA to 3A	0.4		%	
			R _{ISX} = 5.36kΩ, I _{LD} = 3mA to 30mA	0.8			
			R _{ISX} = 160kΩ, I _{LD} = 300μA to 3mA	1.7			

Electrical Characteristics (continued)

(V_{DD} = 3.6V, I_{LD} = 300mA, C_{LD} = 10µF, SEL0 = V_{DD}, SEL1 = V_{DD} (ISH range is selected), T_A = T_{MIN} to T_{MAX}, unless otherwise noted. Typical values are at T_A = +25°C (Note 1))

PARAMETER	SYMBOL	CONDITIONS		MIN	TYP	MAX	UNITS
CMRR_ISX (Note 3)		Measured at ISX, 0V < V _{ISX} < 1.1V	R _{ISX} = 160Ω, I _{LD} = 2A		0.02		%V
			R _{ISX} = 5.36kΩ, I _{LD} = 100mA		0.02		
			R _{ISX} = 160kΩ, I _{LD} = 1mA		0.06		
ISX Residual Current		I _{LD} = 0		20		nA	
AMPLIFIER/DC CHARACTERISTICS							
Typical Input Voltage		Guaranteed by Output Amplifier Gain Error			0.01 to 1.0		V
Offset Voltage	V _{OS}	Input referred (Note 4)			20		µV
PSRR_VOUT		ΔV _{OUT} /ΔV _{DD} , V _{ISX} = 1.0V, 2.5V < V _{DD} < 5.5V			0.2		mV/V
Output Amplifier Gain	G _V				1.5		V/V
Output Amplifier Gain Error	G _{V_ERR}	0.01V < V _{ISX} < 1V		-1	+0.2	+1	%
Output Load Regulation		ΔV _{OUT} /ΔI _{OUT} , sourcing 0 and 2mA, V _{ISX} = 1.0V,			0.1	1	Ω
		ΔV _{OUT} /ΔI _{OUT} , sinking 0 and 500µA, V _{ISX} = 10mV			0.1	1	
Leakage Current Into V _{OUT} (Low Power Mode)		SEL0 = 0V, SEL1 = 0V, at V _{OUT} = 1.5V			5	100	nA
Max Sink Current		V _{ISX} = 0V, V _{OUT} = 1.65V, pulsed test			28		mA
Max Source Current		V _{ISX} = 1.1V, V _{OUT} = 0V, pulsed test			28		mA
Total Transimpedance Gain		R _{ISX} connected to ISX pins			0.003 x R _{ISX}		
Total Transimpedance Gain Error (Measured at V _{OUT})		R _{ISX} = 160Ω, I _{LD} = 3A (Note 6)	-40°C < T _A < +85°C	-4	+0.9	+4	%
			-40°C < T _A < +125°C	-4	+0.9	+4	
		R _{ISX} = 160Ω, I _{LD} = 300mA	-40°C < T _A < +85°C	-3.5	1	+3.5	
			-40°C < T _A < +125°C	-4		+4	
		R _{ISX} = 5.36kΩ, I _{LD} = 30mA	-40°C < T _A < +85°C	-3.5	+0.8	+3.5	
			-40°C < T _A < +125°C	-4		+4	
		R _{ISX} = 160kΩ, I _{LD} = 3mA	-40°C < T _A < +85°C	-6	+1.5	+6	
			-40°C < T _A < +125°C	-7		+7	
		R _{ISX} = 160kΩ, I _{LD} = 1mA	-40°C < T _A < +85°C	-12	+1.8	+12	
			-40°C < T _A < +125°C	-15		+15	
		R _{ISX} = 160kΩ, I _{LD} = 300µA	-40°C < T _A < +85°C	-25	+3	+25	
			-40°C < T _A < +125°C	-30		+30	

Electrical Characteristics (continued)

($V_{DD} = 3.6V$, $I_{LD} = 300mA$, $C_{LD} = 10\mu F$, $SEL0 = V_{DD}$, $SEL1 = V_{DD}$ (ISH range is selected), $T_A = T_{MIN}$ to T_{MAX} , unless otherwise noted. Typical values are at $T_A = +25^\circ C$ (Note 1))

PARAMETER	SYMBOL	CONDITIONS	MIN	TYP	MAX	UNITS
Nonlinearity Total Transimpedance Gain Error (Measured at V_{OUT})		$R_{ISX} = 160\Omega$, $I_{LD} = 100mA$ to $3A$		0.4		%
		$R_{ISX} = 5.36k\Omega$, $I_{LD} = 3mA$ to $100mA$		0.8		
		$R_{ISX} = 160k\Omega$, $I_{LD} = 300\mu A$ to $3mA$		1.7		
AMPLIFIER/AC CHARACTERISTICS						
Small Signal Bandwidth		$R_{ISX} = 160k\Omega$, $I_{LD} = 3mA$ DC and $30\mu A_{App}$, $C_{LD} = 0$		1		MHz
		$R_{ISX} = 160\Omega$, $I_{LD} = 300mA_{DC}$ and $3mA_{App}$, $C_{LD} = 0$		0.7		
Large Signal Bandwidth		$R_{ISX} = 160\Omega$, $I_{LD} = 2A_{DC}$ and $1A_{App}$, $C_{LD} = 0$		300		kHz
Load Transient Response Time		$R_{ISX} = 160k\Omega$, $I_{LD} = 1mA \leftrightarrow 2mA$		220		μs
		$R_{ISX} = 5.36k\Omega$, $I_{LD} = 30mA \leftrightarrow 60mA$		70		μs
		$R_{ISX} = 160\Omega$, $I_{LD} = 1A \leftrightarrow 2A$		60		μs
Output Noise 1/f		0.1Hz to 10Hz		25		μV_{PP}
Output Integrated Noise		100Hz to 10kHz		11		μV_{RMS}
RANGE SELECT INPUTS (SEL0, SEL1)						
Input High Level	V_{IH}	SEL0 and SEL1	1			V
Input Low Level	V_{IL}	SEL0 and SEL1			0.5	V
Input Current	I_{IH}	$V_{IH} = V_{DD}$, SEL0 and SEL1 have weak pulldowns			0.5	μA
	I_{IL}	$V_{IL} = 0V$, SEL0 and SEL1 have weak pulldowns			0.5	
Low Power Mode, Sleep Delay	t_{DIS}	$I_{LD} = 30mA$ (Note 5)		5		μs
Low Power Mode, Waking Delay	t_{EN}	$R_{ISX} = 160\Omega$, $I_{LD} = 300mA$ (Note 5)		30		μs
		$R_{ISX} = 5.36k\Omega$, $I_{LD} = 30mA$ (Note 5)		50		
		$R_{ISX} = 160k\Omega$, $I_{LD} = 1mA$ (Note 6)		550		
Range Control Delay		Measured from 50% level of SEL0 or SEL1 to the 50% rise of the ISX current		6		μs

Note 1: Limits are 100% tested at $T_A = +25^\circ C$. Limits over the temperature range and relevant supply voltage range are guaranteed by design and characterization.

Note 2: ISX is any one of the ISL, ISM or ISH pins.

Note 3: $CMRR_{ISX}$ is calculated as $(\Delta I_{ISX} / I_{ISX}) / \Delta V_{ISX}$.

Note 4: Guaranteed by circuit architecture.

Note 5: Measured from 50% level of SEL0 or SEL1 edge to 50% reduction in the ISX current.

Note 6: Guaranteed by design.

Typical Operating Characteristics

$V_{DD} = 3.6V$, $I_{LD} = 300mA$, $C_{LD} = 10\mu F$, $R_{OUT} = 10k\Omega$, $C_{OUT} = 10pF$, $R_{ISH} = 160\Omega$, $R_{ISM} = 5.36k\Omega$, $R_{ISL} = 160k\Omega$ (per the MAX40016 EV kit). Typical values are at $T_A = +25^\circ C$, unless otherwise noted. (ISX is any one of the ISL, ISM or ISH pins.)

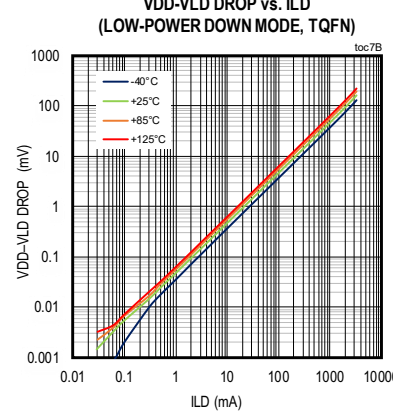
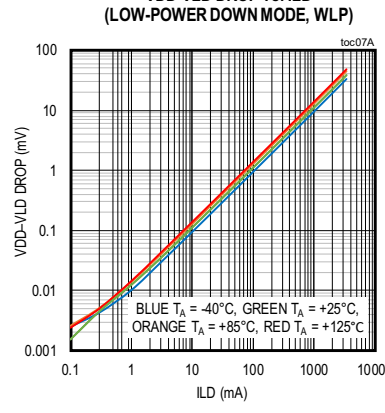
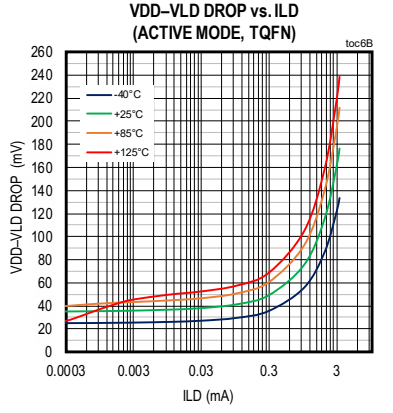
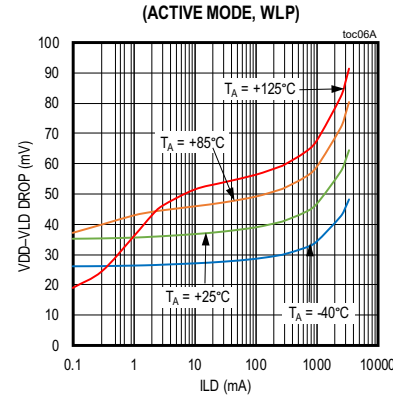
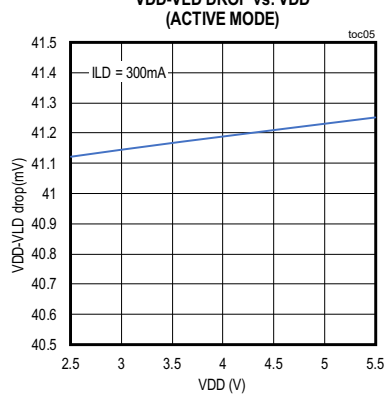
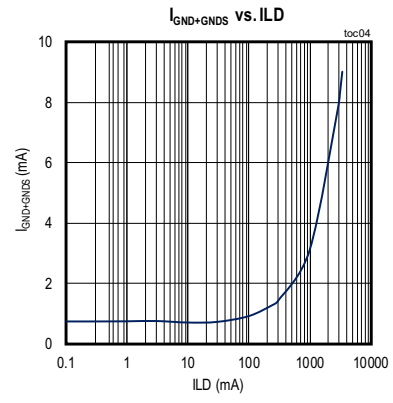
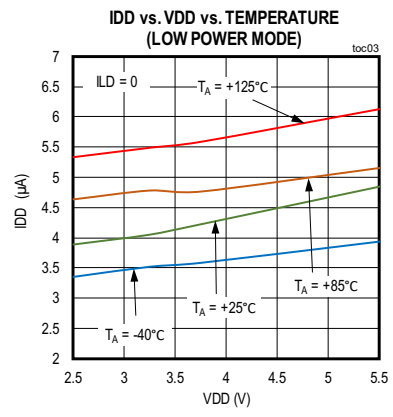
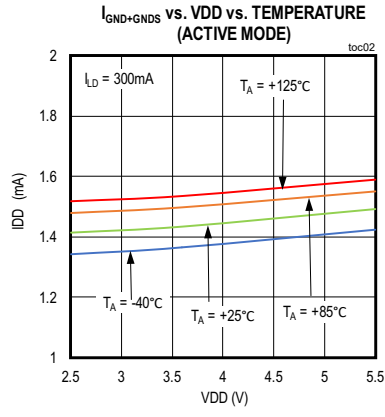

Typical Operating Characteristics (continued)

$V_{DD} = 3.6V$, $I_{LD} = 300mA$, $C_{LD} = 10\mu F$, $R_{OUT} = 10k\Omega$, $C_{OUT} = 10pF$, $R_{ISH} = 160\Omega$, $R_{ISM} = 5.36k\Omega$, $R_{ISL} = 160k\Omega$ (per the MAX40016 EV kit). Typical values are at $T_A = +25^\circ C$, unless otherwise noted. (ISX is any one of the ISL, ISM or ISH pins.)



Typical Operating Characteristics (continued)

$V_{DD} = 3.6V$, $I_{LD} = 300mA$, $C_{LD} = 10\mu F$, $R_{OUT} = 10k\Omega$, $C_{OUT} = 10pF$, $R_{ISX} = 160\Omega$, $R_{ISM} = 5.36k\Omega$, $R_{ISL} = 160k\Omega$ (per the MAX40016 EV kit). Typical values are at $T_A = +25^\circ C$, unless otherwise noted. (ISX is any one of the ISL, ISM or ISH pins.)

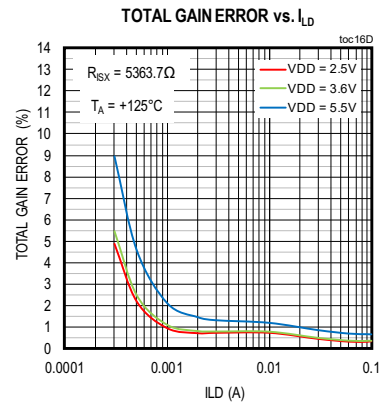
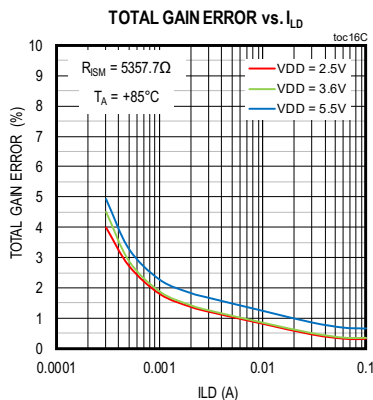
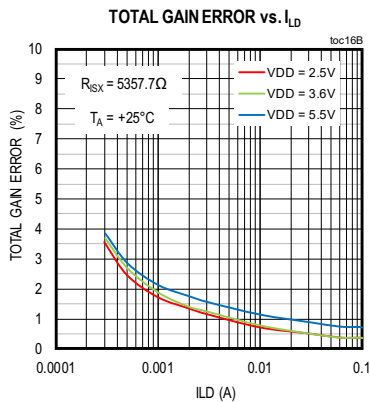
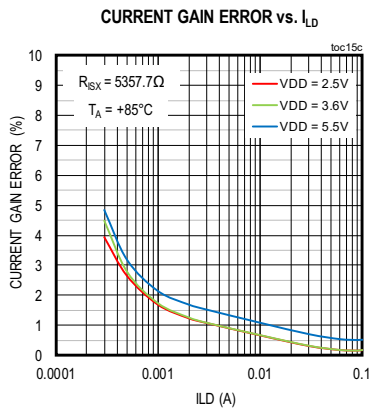
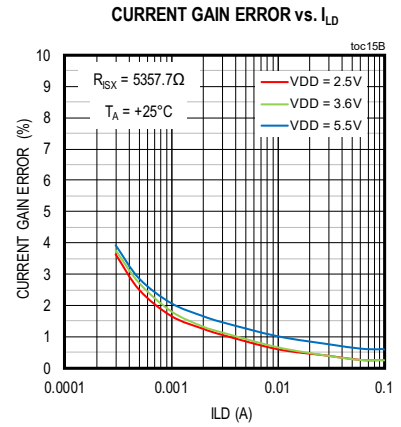

Typical Operating Characteristics (continued)

$V_{DD} = 3.6V$, $I_{LD} = 300mA$, $C_{LD} = 10\mu F$, $R_{OUT} = 10k\Omega$, $C_{OUT} = 10pF$, $R_{ISX} = 160\Omega$, $R_{ISM} = 5.36k\Omega$, $R_{ISL} = 160k\Omega$ (per the MAX40016 EV kit). Typical values are at $T_A = +25^\circ C$, unless otherwise noted. (ISX is any one of the ISL, ISM or ISH pins.)

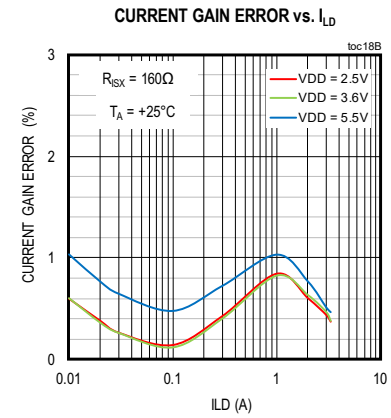
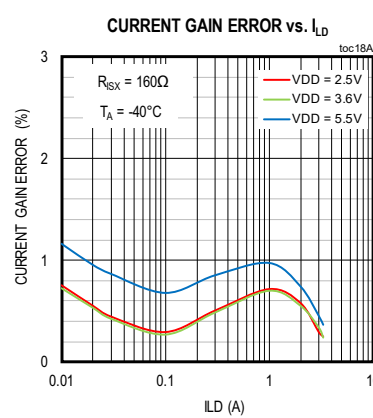
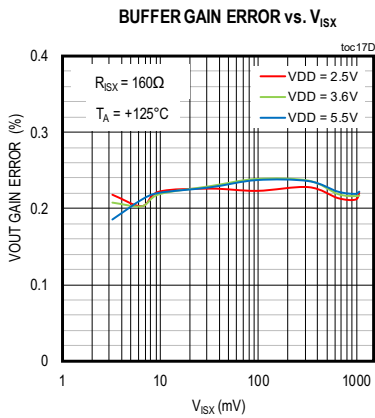

Typical Operating Characteristics (continued)

$V_{DD} = 3.6V$, $I_{LD} = 300mA$, $C_{LD} = 10\mu F$, $R_{OUT} = 10k\Omega$, $C_{OUT} = 10pF$, $R_{ISX} = 160\Omega$, $R_{ISH} = 160\Omega$, $R_{ISM} = 5.36k\Omega$, $R_{ISL} = 160k\Omega$ (per the MAX40016 EV kit). Typical values are at $T_A = +25^\circ C$, unless otherwise noted. (ISX is any one of the ISL, ISM or ISH pins.)

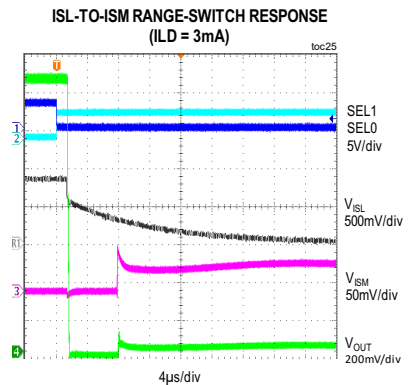
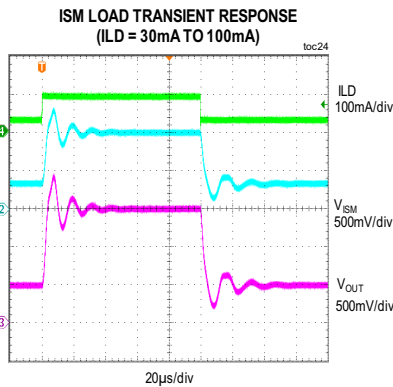
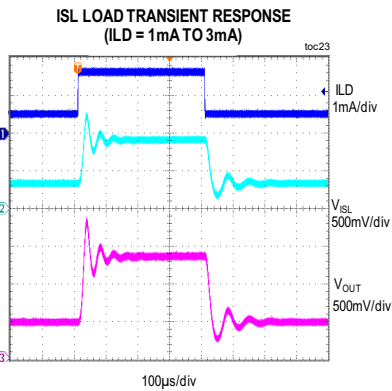
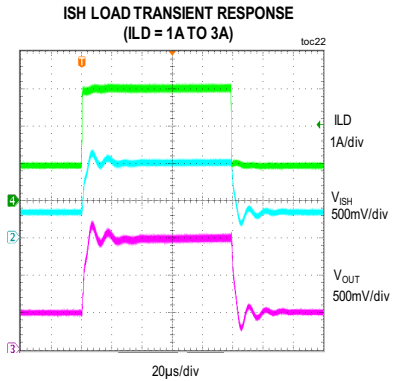
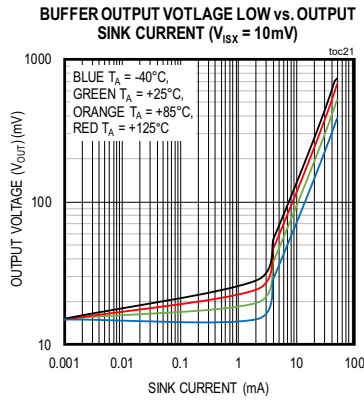
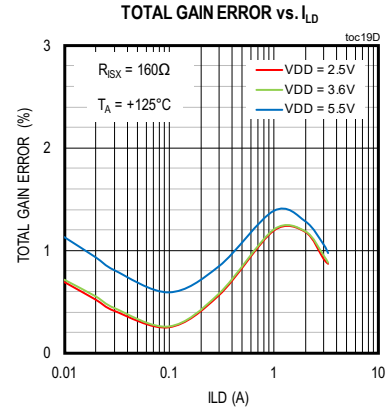

Typical Operating Characteristics (continued)

$V_{DD} = 3.6V$, $I_{LD} = 300mA$, $C_{LD} = 10\mu F$, $R_{OUT} = 10k\Omega$, $C_{OUT} = 10pF$, $R_{ISH} = 160\Omega$, $R_{ISM} = 5.36k\Omega$, $R_{ISL} = 160k\Omega$ (per the MAX40016 EV kit). Typical values are at $T_A = +25^\circ C$, unless otherwise noted. (ISX is any one of the ISL, ISM or ISH pins.)

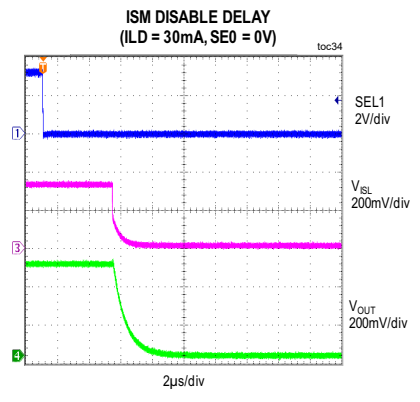
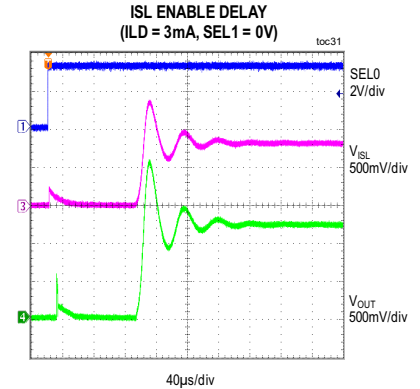

Typical Operating Characteristics (continued)

$V_{DD} = 3.6V$, $I_{LD} = 300mA$, $C_{LD} = 10\mu F$, $R_{OUT} = 10k\Omega$, $C_{OUT} = 10pF$, $R_{ISH} = 160\Omega$, $R_{ISM} = 5.36k\Omega$, $R_{ISL} = 160k\Omega$ (per the MAX40016 EV kit). Typical values are at $T_A = +25^\circ C$, unless otherwise noted. (ISX is any one of the ISL, ISM or ISH pins.)

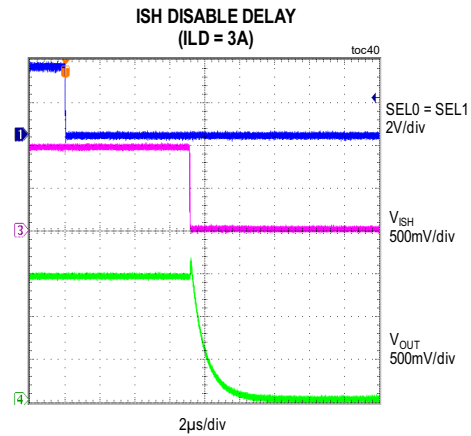
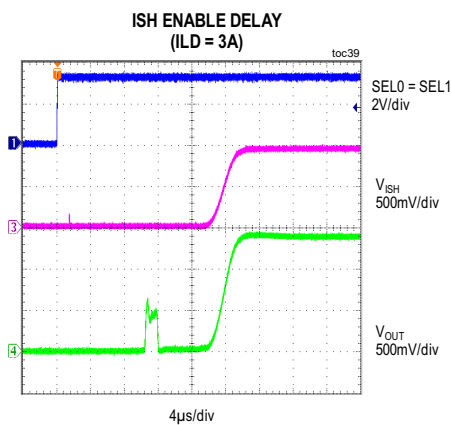
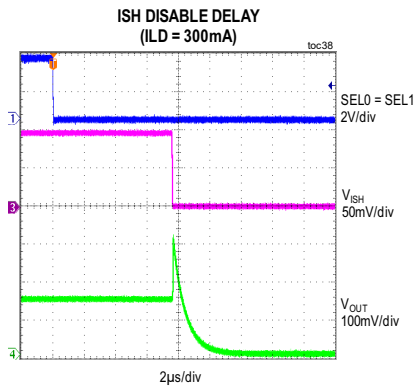
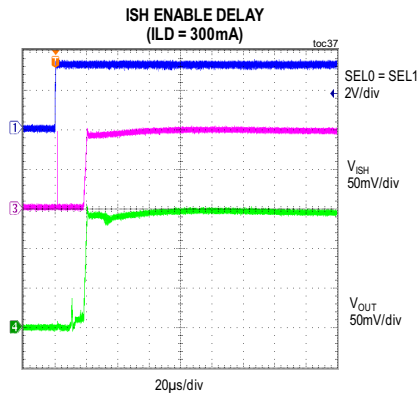
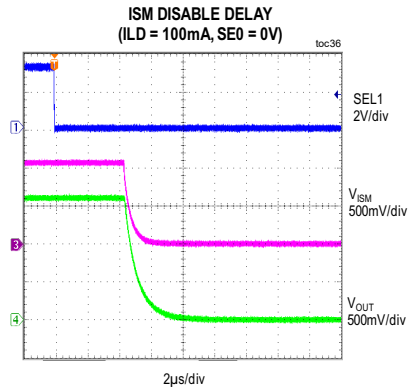
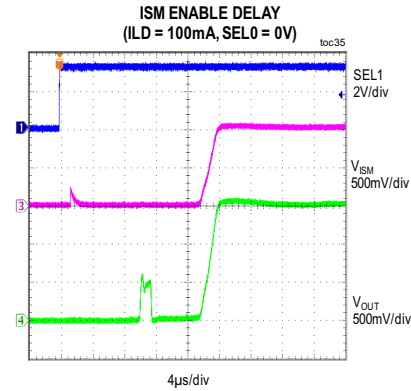

Typical Operating Characteristics (continued)

$V_{DD} = 3.6V$, $I_{LD} = 300mA$, $C_{LD} = 10\mu F$, $R_{OUT} = 10k\Omega$, $C_{OUT} = 10pF$, $R_{ISH} = 160\Omega$, $R_{ISM} = 5.36k\Omega$, $R_{ISL} = 160k\Omega$ (per the MAX40016 EV kit). Typical values are at $T_A = +25^\circ C$, unless otherwise noted. (ISX is any one of the ISL, ISM or ISH pins.)

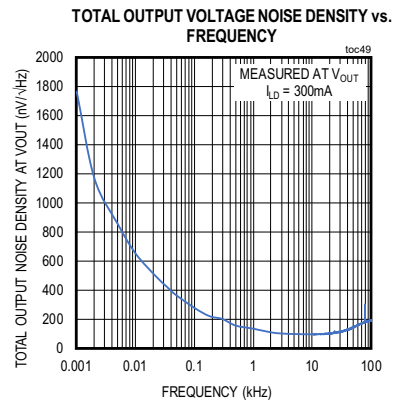
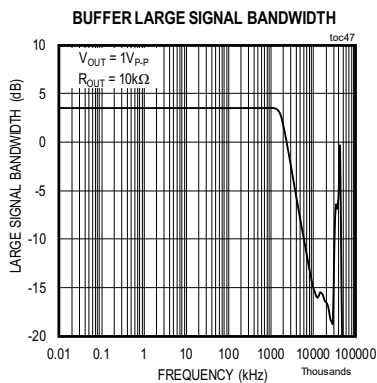
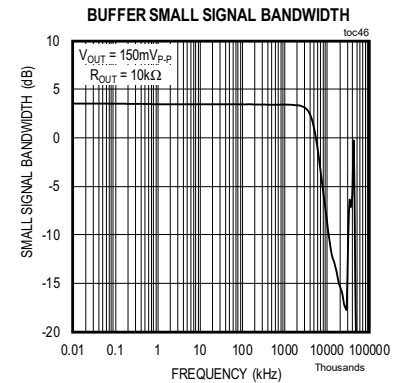
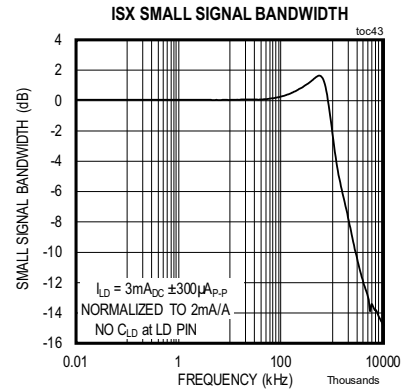
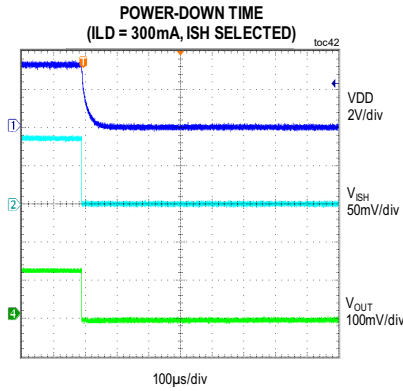

Pin Configuration



Pin Description

PIN		NAME	FUNCTION
WLP	TQFN		
C1, A2, B2, C2	1, 4, 5, 16	V _{DD}	Device V _{DD} Supply and Measured Current Input. Bypass V _{DD} to GND with a 0.1µF and a 10µF ceramic capacitors in parallel as close to the device as possible.
A3, B3, C3	6, 7, 15	LD	Measured Current Output. Connect LD to the load side. Bypass LD to GND with a 10µF ceramic capacitor.
C5	11	ISH*	High Current Range Output. Connect a resistor from ISH to GND to scale the V _{OUT} range.
A4	8	ISM*	Middle Current Range Output. Connect a resistor from ISM to GND to scale the V _{OUT} range.
A5	9	ISL*	Low Current Range Output. Connect a resistor from ISL to GND to scale the V _{OUT} range.
B4	12	GNDS	Ground. Return of the output amplifier's gain setting network. Connect GNDS to GND.
C4	13	GND	Circuit Ground. All signals are referenced to GND.
B1	2	SEL0	Logic Selection Input 0 (see Table 1).
A1	3	SEL1	Logic Selection Input 1 (see Table 1).
B5	10	V _{OUT}	Amplifier Output Voltage. V _{OUT} is proportional to the V _{DD} to ILD current. The scaling factor depends on the resistor values on the ISL, ISM, and ISH inputs.
—	14	N.C.	No Connect. Internally not connected.
—	EP	EP	Exposed Pad. Internally connected to GND. Connect to a large ground plane to maximize thermal performance. Do not use EP as the only ground connection.

*ISL, ISM, and ISH are electrically identical and named to differentiate among the three selectable outputs. Each output when selected is able to support the full-scale sense current range.

Detailed Description

The MAX40016 CSA contains an integrated current-sensing element saving the space and cost of an external sense resistor. Having an integrated sense element has the extra advantage that the entire current measuring path can be factory trimmed, saving the user from having to calibrate independent sense resistors and CSAs.

The CSA has a low power mode in which the current-sensing element remains on, but the output and internal circuitry are turned off to bring the total supply current well below 10 μ A. In this mode, the pass element is turned fully on and will therefore drop slightly less voltage than while it is measuring current. Low power mode is selected by applying a logic-low to both SEL0 and SEL1 (see [Table 1](#)).

Three multiplexed scaling outputs from the wide range CSA allow the use of different scaling resistors so that a 12-bit ADC can be sufficient with simple resistor range selection. If only one output is used, an ADC with at least 15 bits of resolution will be needed to realize the full dynamic range of the CSA. See the applications section for details. Each of the scaled outputs are available as a voltage from the V_{OUT} pin.

The V_{OUT} amplifier output is capable of driving a wide range of ADCs and has a gain of 1.5V/V to provide a full-scale of 1.5V. Most of the values shown in this document are for a full-scale output of 1.5V, suited for 1.8V controllers with embedded 10 to 16-bit ADCs.

The MAX40016 senses from less than 300 μ A to greater than 3A current range. The output maintains less than 5% error specification over a 10,000:1 ratio. In theory, this requires an ADC with a resolution exceeding 13 bits to realize its full dynamic range. While such ADCs are readily available, the system microcontroller already has an embedded 12-bit ADC in many cases.

The three multiplexed scaling current outputs from MAX40016 allow the span to be divided into three ranges that are well within a lower-resolution ADC's capability. Note that it is the same current that is switched to one of the three outputs at a time. The ISH, ISM and ISL pin names are mainly to indicate which output pin is selected. The MAX40016 has its ranges selected using the SEL0 and SEL1 pins. See [Current Sense Range Selection \(SEL0, SEL1\)](#) section and ([Table 1](#)) for all the modes.

Scaling Resistors

The multiplexed scaling resistors' values (R_{ISH}, R_{ISM}, R_{ISL}) should be chosen to suit the ADC's full-scale, usually defined by its reference voltage (V_{REF}). Care should be taken to account for all tolerances to avoid overloading the ADC. The typical current from the MAX40016's ISL, or ISM, or ISH pin is specified as 2mA/A. The internal amplifier has a gain of 1.5V/V. Resistors of 0.1% are readily available and so the nominal resistance value is given by:

$$R_{ISX} = \frac{V_{REF} / 1.5}{(I_{FS} \times 0.002)} (\Omega)$$

The R_{ISX} determined from the above equation, where the voltage across the scaling resistor should be limited to 1V, which corresponds to 1.5V full-scale after the amplifier. The closest E192 available value is 167 Ω which gives very little over-current margin. A 160 Ω R_{ISX} value offers a little more margin towards a conservative design.

Current Sense Range Selection (SEL0, SEL1)

SEL0 and SEL1 are digital inputs decoded to control the mirroring of the sense current on the V_{DD} to LD path to one of three scaled current outputs (ISH, ISM, or ISL), as shown in [Table 1](#). When both SEL0 and SEL1 are at logic 0, the MAX40016 enters its low power operating mode.

Table 1. Current Sense Range Selection

SEL0	SEL1	OPERATING MODE/RANGE
0	0	Low Power Mode is Enabled. V _{OUT} is high impedance. In low power mode, the current-sensing element still passes current just as an external sense resistor would. There is no capability to turn off the current.
0	1	Middle Current Sense Range (ISM) is Enabled. The resistor R _{ISM} connected at this current output terminal defines the full-scale voltage of 1V to the internal amplifier.
1	0	Low Current Sense Range (ISL) is Enabled. The resistor R _{ISL} connected at this current output terminal defines the full-scale voltage of 1V to the internal amplifier.
1	1	High Current Sense Range (ISH) is Enabled. The resistor R _{ISH} connected at this current output terminal defines the full-scale voltage of 1V to the internal amplifier.

Note: ISL, ISM, ISH can support all current range from low end to high end. The only difference is that they are selected by different SEL0/SEL1 combination.

Low Power Mode

The MAX40016 has a low power mode that is activated by pulling both SEL0 and SEL1 low. In this mode, all of the internal circuitry is shut down to save power. The output amplifier is placed in a high impedance state to allow multiplexing of the output line with another MAX40016 for example. In low power mode, the current-sensing element still passes current just as an external sense resistor would. There is no capability to turn off the current.

ISX Residual Current

When at no load current ($I_{LD} = 0$), there is a small internal residual current at ISX pin due to the internal current mirror block mechanism. This residual current is not an offset current and should not have effect when there is a load current being sensed. Refer to [Typical Operating Characteristics](#) for the typical information of this residual current over the the temperature range and V_{DD} supply voltage range.

Device Power Up

Initially, the MAX40016 powers up in low power mode, regardless of the state of SEL0 and SEL1. After the power-up delay time (100 μ s), the part reverts to the mode selected by SEL0 and SEL1.

Applications Information

ESD Clamps

The diagram shows the internal ESD clamping diodes that protect the MAX40016 against electrostatic discharge.

Power Supplies and Bypassing

The MAX40016 operates from single supply voltage +2.5V to +5.5V. The V_{DD} supply input is also the measured

current input terminal. Pay extra attention to bypassing and grounding the MAX40016. Peak supply and measured output currents may exceed 3A when the load side experiences large current transients with large external capacitive loads. Supply drops and ground shifts may degrade the device performance. Ground shifts due to insufficient device grounding may also disturb other circuits sharing the same AC ground return path. Any series inductance in the V_{DD} , LD and/or GND paths can cause oscillations due to the very high di/dt when switching the MAX40016 with any capacitive load. Bypass V_{DD} supply to ground with a 0.1 μ F in parallel with a 10 μ F ceramic capacitors as close as possible to the device. Bypass the measured current output, LD terminal, with a 10 μ F ceramic capacitor or larger depending on the sensing load current, additional bypassing may be needed to keep the device stable during large load output transitions.

Layout Guidelines

Due to the high currents that may flow through the integrated sensing element based on the application, take care to eliminate solder and parasitic trace resistance from causing errors. Using thicker copper in the PCB construction for these high currents is recommended. Use of Kelvin (force and sense) PCB layout techniques or use of a multilayer PCB with separate ground, power supply and load planes is recommended for noisy digital environments (see the MAX40016EVKIT# data sheet for a layout example). Keep digital signals far away from the sensitive analog inputs. Unshielded long traces at the input and output sense terminals of the device can degrade performance due to noise pick-up.

Application Information



Figure 1. Functional Diagram Showing ESD Clamps

Typical Application Circuits

When the chosen ADC has sufficient resolution to handle the MAX40016 full dynamic range (4-decade of sensing range), only the R_{ISH} resistor is required (Figure 2). For a full-scale of 3A the value of R_{ISH} is 160Ω for a 1V full-scale at the ISH pin, which corresponds to 1.5V output at V_{OUT} .

Determining the nominal value of R_{ISH} :

The amplifier has a nominal gain of 1.5V/V and the output full-scale voltage is optimized to be 1.5V. So the full-scale voltage across R_{ISH} is 1V.

The current division factor F_{DV} (from sensing channel to ISH) is 500 (i.e., 2mA/A).

The full-scale sensed current (I_{FS}) is divided by F_{DV} and the divided current flows through R_{ISH} .

Thus, $I_{RSH} = I_{FS}/F_{DV}$, giving $R_{ISH} = F_{DV}/I_{FS}$.

Example #1: Using a MAX11214 (24-bit at 64ksps).

The high sampling rate of the MAX11214 renders an anti-aliasing filter unnecessary. Only the R_{ISH} resistor is needed to define the gain and the internal programmable gain amplifier inside the ADC allows the selection of reference voltages to match with the 1.5V full-scale from MAX40016. Alternatively, the MAX40016's output buffer can be bypassed and the ADC can be connected directly to the ISH pin, to read the voltage across R_{ISH} directly (see Figure 3). If the PCB layout requires a long distance between the MAX40016 and the ADC, the current output from ISH should be run across the PCB and the R_{ISH} terminating resistor placed as close as possible to the ADC's input. This helps reduce errors caused by voltage drops across the PCB.

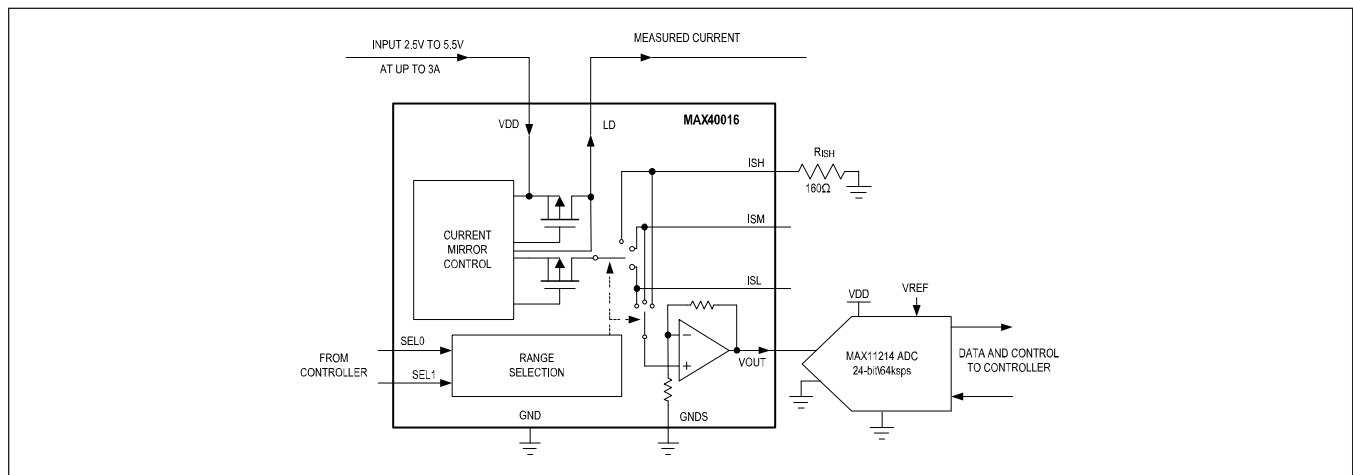

Figure 2. Using the MAX40016 with MAX11214 24-Bit, 64ksps ADC (Single Scaling Resistor with Internal Buffer)

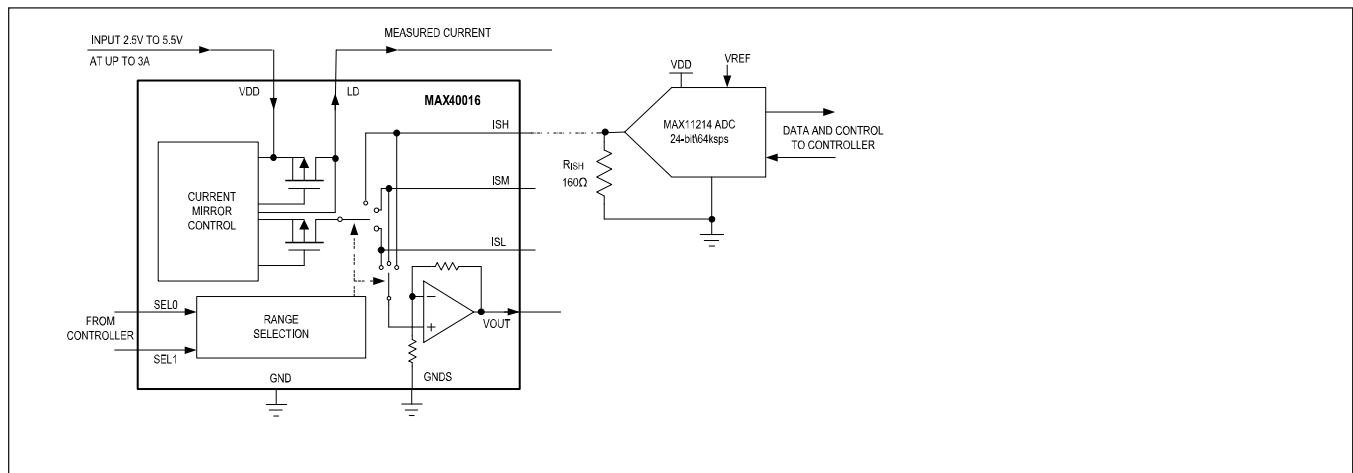

Figure 3. Using the MAX40016 with MAX11214 24-Bit, 64ksps ADC (Single Scaling Resistor without Internal Buffer)

Implementation with Lower Resolution ADCs

When two or three ranges are required, as in the case of a 10-bit to 12-bit ADC, the higher range resistor (R_{ISH}) is calculated as described above. Calculating R_{ISM} and or R_{ISL} follows the same method with the only difference being the full-scale current is now the lower-range full-scale current. Exactly where it is optimum to arrange this current will depend on the system. Typically splitting the ranges in the region of 30:1 is suitable for most applications. Using $R_{ISH} = 160\Omega$, $R_{ISM} = 5.3k\Omega$, and $R_{ISL} = 160k\Omega$ to split the range up equally (Figure 4). However, this range transition value can be chosen such that the most commonly expected readings would have the better resolution. Selecting too low a transition point leads to more, presumably unnecessary, quantization noise in the higher range.

Example #2: Using an Embedded 12-bit ADC

The following example uses a typical moderate-speed SAR ADC with a 25pF sampling capacitor (C_{IN}) and 1.5us acquisition time (T_{ACQ}).

In the idle state, the ADC's input impedance is high. When the ADC begins its acquisition phase the input impedance becomes C_{IN} in series with R_{IN} . The amplifier is thus presented with a transient change in load impedance. Adding an RC network (R_F and C_F), as shown in Figure 4, serves to reduce the load transient seen by the amplifier.

Begin by selecting the value of C_F which serves as a "charge reservoir" for the ADC's input stage. When the ADC begins its acquisition phase, C_F should be able to provide the charge required by the internal sampling capacitor (C_{IN}) without excessive droop. A sufficiently large C_F therefore reduces the load transient seen by the amplifier. It is generally appropriate to target between 2% and 5% droop at ADC input. This then results in a value of C_F that is between 20 and 50 times the value of C_{IN} . For the capacitor type use a C0G (or NP0) ceramic chip capacitor and place it between ADC input and the ground plane, as close as possible to the ADC. In this example, with $C_{IN} = 25pF$, the external capacitance value should be between 500pF and 1,250pF and a good choice is a 1.2nF C0G capacitor.



Figure 4. Using the MAX40016 with an Embedded 12-Bit ADC

The next step is to choose the value of R_F . Two characteristics of the ADC should be considered when calculating R_F : the acquisition time of converter (T_{ACQ}) and the ADC sampling capacitance (C_{IN}). In addition, the RC network will require several time constants to settle once the sampling switch is closed. If the ADC's resolution is 12 bits, and the input needs to settle to less than 0.5LSB, then 9 time constants will be required. Because settling must occur during the acquisition period, $R_F * C_F * 9$ must be less than or equal to T_{ACQ} if the error introduced by

the external RC network is to be less than 0.5LSB. This results in a value of 139Ω or less for R_F .

Finally, to ensure stability, the cutoff frequency of the R_F - C_F low-pass filter should be smaller than the gain-bandwidth product of the amplifier. Choosing 130Ω and 1.2nF yields about 1MHz which is smaller than the 1.5MHz gain-bandwidth product of the amplifier. Note that Voltage at ISH, ISM, ISL pins should not exceed 1.1V for proper operation (see *Input Voltage Range Under Amplifier* section of the [Electrical Characteristics](#) table).

Ordering Information

PART	TEMP RANGE	PIN-PACKAGE	TOP MARK
MAX40016ANL+T	-40°C to +125°C	15 WLP	+AAB
MAX40016ATE+T	-40°C to +125°C	16 TQFN	—

+Denotes a lead(Pb)-free/RoHS-compliant package.
T = Denotes tape-and-reel.

Revision History

REVISION NUMBER	REVISION DATE	DESCRIPTION	PAGES CHANGED
0	1/18	Initial release	—
1	8/18	Updated <i>Benefits and Features</i> , <i>Absolute Maximum Ratings</i> , <i>Package Information</i> , <i>Electrical Characteristics</i> , <i>Typical Operating Characteristics</i> , <i>Pin Description</i> , and <i>Ordering Information</i>	1, 3–5, 7–15, 22
2	11/18	Updated <i>General Description</i> , <i>Benefits and Features</i> , data sheet title, <i>Simplified Block Diagram</i> , <i>Typical Operating Characteristics</i> global conditions and graphs, and <i>Typical Application Circuits</i>	1, 2, 7, 14, 21

For pricing, delivery, and ordering information, please visit Maxim Integrated's online storefront at <https://www.maximintegrated.com/en/storefront/storefront.html>.

Maxim Integrated cannot assume responsibility for use of any circuitry other than circuitry entirely embodied in a Maxim Integrated product. No circuit patent licenses are implied. Maxim Integrated reserves the right to change the circuitry and specifications without notice at any time. The parametric values (min and max limits) shown in the Electrical Characteristics table are guaranteed. Other parametric values quoted in this data sheet are provided for guidance.



Компания «ЭлектроПласт» предлагает заключение долгосрочных отношений при поставках импортных электронных компонентов на взаимовыгодных условиях!

Наши преимущества:

- Оперативные поставки широкого спектра электронных компонентов отечественного и импортного производства напрямую от производителей и с крупнейших мировых складов;
- Поставка более 17-ти миллионов наименований электронных компонентов;
- Поставка сложных, дефицитных, либо снятых с производства позиций;
- Оперативные сроки поставки под заказ (от 5 рабочих дней);
- Экспресс доставка в любую точку России;
- Техническая поддержка проекта, помощь в подборе аналогов, поставка прототипов;
- Система менеджмента качества сертифицирована по Международному стандарту ISO 9001;
- Лицензия ФСБ на осуществление работ с использованием сведений, составляющих государственную тайну;
- Поставка специализированных компонентов (Xilinx, Altera, Analog Devices, Intersil, Interpoint, Microsemi, Aeroflex, Peregrine, Syfer, Eurofarad, Texas Instrument, Miteq, Cobham, E2V, MA-COM, Hittite, Mini-Circuits, General Dynamics и др.);

Помимо этого, одним из направлений компании «ЭлектроПласт» является направление «Источники питания». Мы предлагаем Вам помощь Конструкторского отдела:

- Подбор оптимального решения, техническое обоснование при выборе компонента;
- Подбор аналогов;
- Консультации по применению компонента;
- Поставка образцов и прототипов;
- Техническая поддержка проекта;
- Защита от снятия компонента с производства.



Как с нами связаться

Телефон: 8 (812) 309 58 32 (многоканальный)

Факс: 8 (812) 320-02-42

Электронная почта: org@eplast1.ru

Адрес: 198099, г. Санкт-Петербург, ул. Калинина, дом 2, корпус 4, литера А.