

FEATURES

- JESD204B (Subclass 1) coded serial digital outputs
 - 2.0 W total power at 1 GSPS (default settings)
 - 1.5 W total power at 500 MSPS (default settings)
 - SFDR = 85 dBFS at 340 MHz, 80 dBFS at 985 MHz
 - SNR = 65.3 dBFS at 340 MHz ($A_{IN} = -1.0$ dBFS),
60.5 dBFS at 985 MHz
 - ENOB = 10.8 bits at 10 MHz
 - DNL = ± 0.5 LSB
 - INL = ± 2.5 LSB
 - Noise density = -154 dBFS/Hz at 1 GSPS
 - 1.25 V, 2.5 V, and 3.3 V dc supply operation
 - No missing codes
 - Internal ADC voltage reference
 - Flexible input range
 - AD9690-1000: 1.46 V p-p to 1.94 V p-p (1.70 V p-p nominal)
 - AD9690-500: 1.46 V p-p to 2.06 V p-p (2.06 V p-p nominal)
 - Programmable termination impedance
 - 400 Ω , 200 Ω , 100 Ω , and 50 Ω differential
 - 2 GHz usable analog input full power bandwidth
 - Amplitude detect bits for efficient AGC implementation
 - 2 integrated wideband digital processors
 - 12-bit NCO, up to 4 cascaded half-band filters
 - Differential clock input
 - Integer clock divide by 1, 2, 4, or 8
 - Flexible JESD204B lane configurations
 - Small signal dither
- ## APPLICATIONS
- Communications
 - Multiband, multimode digital receivers
 - 3G/4G, TD-SCDMA, W-CDMA, GSM, LTE
 - General-purpose software radios
 - Ultrawideband satellite receivers
 - Instrumentation
 - Radars
 - Signals intelligence (SIGINT)
 - DOCSIS 3.0 CMTS upstream receive paths
 - HFC digital reverse path receivers
 - Wideband digital predistortion

FUNCTIONAL BLOCK DIAGRAM

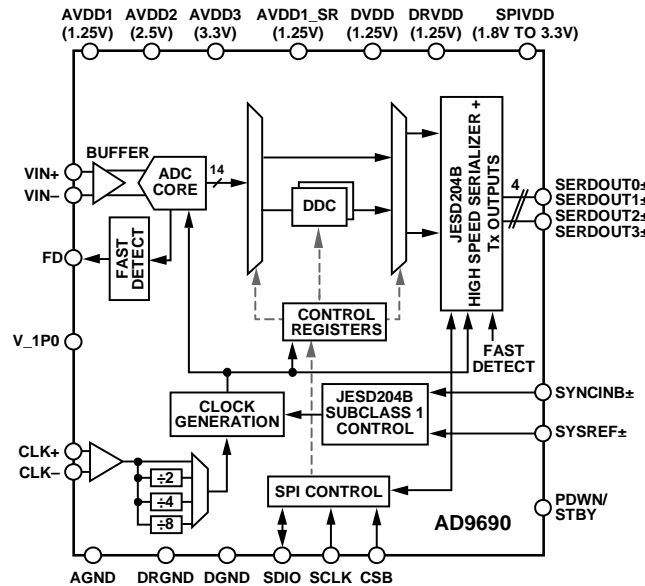

Figure 1.

PRODUCT HIGHLIGHTS

1. Wide full power bandwidth supports IF sampling of signals up to 2 GHz.
2. Buffered inputs with programmable input termination eases filter design and implementation.
3. Two integrated wideband decimation filters and numerically controlled oscillator (NCO) blocks supporting multiband receivers.
4. Flexible serial port interface (SPI) controls various product features and functions to meet specific system requirements.
5. Programmable fast overrange detection.
6. 9 mm × 9 mm, 64-lead LFCSP.

TABLE OF CONTENTS

Features	1	DDC NCO Plus Mixer Loss and SFDR.....	42
Applications.....	1	Numerically Controlled Oscillator	42
Functional Block Diagram	1	FIR Filters	44
Product Highlights	1	General Description.....	44
Revision History	3	Half-Band Filters	45
General Description	4	DDC Gain Stage	47
Specifications.....	5	DDC Complex—Real Conversion	47
DC Specifications	5	DDC Example Configurations	48
AC Specifications.....	6	Digital Outputs	49
Digital Specifications	7	Introduction to the JESD204B Interface	49
Switching Specifications	8	JESD204B Overview	49
Timing Specifications	9	Functional Overview	50
Absolute Maximum Ratings.....	11	JESD204B Link Establishment	50
Thermal Characteristics	11	Physical Layer (Driver) Outputs	52
ESD Caution.....	11	JESD204B Tx Converter Mapping.....	54
Pin Configuration and Function Descriptions.....	12	Configuring the JESD204B Link.....	55
Typical Performance Characteristics	14	Multichip Synchronization.....	57
AD9690-1000.....	14	SYSREF± Setup/Hold Window Monitor.....	59
AD9690-500.....	18	Test Modes.....	61
Equivalent Circuits	22	ADC Test Modes	61
Theory of Operation	24	JESD204B Block Test Modes	62
ADC Architecture	24	Serial Port Interface.....	64
Analog Input Considerations.....	24	Configuration Using the SPI.....	64
Voltage Reference	28	Hardware Interface.....	64
Clock Input Considerations	29	SPI Accessible Features.....	64
ADC Overrange and Fast Detect.....	31	Memory Map	65
ADC Overrange.....	31	Reading the Memory Map Register Table.....	65
Fast Threshold Detection (FD).....	31	Memory Map Register Table.....	66
Signal Monitor	32	Applications Information	77
SPORT Over JESD204B.....	32	Power Supply Recommendations.....	77
Digital Downconverter (DDC).....	35	Exposed Pad Thermal Heat Slug Recommendations.....	77
DDC I/Q Input Selection	35	AVDD1_SR (Pin 57) and AGND (Pin 56 and Pin 60).....	77
DDC I/Q Output Selection	35	Outline Dimensions	78
DDC General Description	35	Ordering Guide	78
Frequency Translation	41		
General Description.....	41		

REVISION HISTORY

5/2017—Rev. A to Rev. B

Changes to Junction Temperature Range Parameter, Table 6 ...11
Updated Outline Dimensions.....78
Changes to Ordering Guide.....78

7/2016—Rev. 0 to Rev. A

Changes to General Description Section4
Changes to Ordering Guide.....78

1/2015—Revision 0: Initial Version

GENERAL DESCRIPTION

The [AD9690](#) is a 14-bit, 1 GSPS/500 MSPS analog-to-digital converter (ADC). The device has an on-chip buffer and sample-and-hold circuit designed for low power, small size, and ease of use. This device is designed for sampling wide bandwidth analog signals of up to 2 GHz. The [AD9690](#) is optimized for wide input bandwidth, high sampling rate, excellent linearity, and low power in a small package.

The ADC core features a multistage, differential pipelined architecture with integrated output error correction logic. The ADC features wide bandwidth inputs supporting a variety of user-selectable input ranges. An integrated voltage reference eases design considerations.

The analog input and clock signals are differential inputs. The ADC data output is internally connected to two digital down-converters (DDCs). Each DDC consists of four cascaded signal processing stages: a 12-bit frequency translator (NCO), and four half-band decimation filters.

In addition to the DDC blocks, the [AD9690](#) has several functions that simplify the automatic gain control (AGC) function in the communications receiver.

The programmable threshold detector allows monitoring of the incoming signal power using the fast detect output bits of the ADC. If the input signal level exceeds the programmable threshold, the fast detect indicator goes high. Because this threshold indicator has low latency, the user can quickly turn down the system gain to avoid an overrange condition at the ADC input.

Users can configure the Subclass 1 JESD204B-based high speed serialized output in a variety of one-, two-, or four-lane configurations, depending on the DDC configuration and the acceptable lane rate of the receiving logic device. Multiple device synchronization is supported through the SYSREF± and SYNCINB± input pins.

The [AD9690](#) has flexible power-down options that allow significant power savings when desired. All of these features can be programmed using a 1.8 V to 3.3 V capable 3-wire SPI.

The [AD9690](#) is available in a Pb-free, 64-lead LFCSP and is specified over the -40°C to +85°C industrial temperature range. This product may be protected by one or more U.S. or international patents

SPECIFICATIONS

DC SPECIFICATIONS

AVDD1 = 1.25 V, AVDD2 = 2.5 V, AVDD3 = 3.3 V, AVDD1_SR = 1.25 V, DVDD = 1.25 V, DRVDD = 1.25 V, SPIVDD = 1.8 V, specified maximum sampling rate for each speed grade, $A_{IN} = -1.0$ dBFS, clock divider = 2, default SPI settings, $T_A = 25^\circ\text{C}$, unless otherwise noted.

Table 1.

Parameter	Temperature	AD9690-500			AD9690-1000			Unit
		Min	Typ	Max	Min	Typ	Max	
RESOLUTION	Full	14			14			Bits
ACCURACY		Guaranteed			Guaranteed			
No Missing Codes	Full							
Offset Error	Full	-0.3	0	+0.3	-0.31	0	+0.31	% FSR
Gain Error	Full	-6	0	+6	-6	0	+6	% FSR
Differential Nonlinearity (DNL)	Full	-0.6	± 0.5	+0.7	-0.7	± 0.5	+0.8	LSB
Integral Nonlinearity (INL)	Full	-4.5	± 2.5	+5.0	-5.7	± 2.5	+6.9	LSB
TEMPERATURE DRIFT								
Offset Error	25°C	-9			-14			ppm/°C
Gain Error	25°C	± 25			± 13.8			ppm/°C
INTERNAL VOLTAGE REFERENCE								
Voltage	Full	1.0			1.0			V
INPUT-REFERRED NOISE								
$V_{REF} = 1.0$ V	25°C	2.06			2.63			LSB rms
ANALOG INPUTS								
Differential Input Voltage Range (Programmable)	Full	1.46	2.06	2.06	1.46	1.70	1.94	V p-p
Common-Mode Voltage (V_{CM})	25°C	2.05			2.05			V
Differential Input Capacitance	25°C	1.5			1.5			pF
Analog Input Full Power Bandwidth	25°C	2			2			GHz
POWER SUPPLY								
AVDD1	Full	1.22	1.25	1.28	1.22	1.25	1.28	V
AVDD2	Full	2.44	2.5	2.56	2.44	2.5	2.56	V
AVDD3	Full	3.2	3.3	3.4	3.2	3.3	3.4	V
AVDD1_SR	Full	1.22	1.25	1.28	1.22	1.25	1.28	V
DVDD	Full	1.22	1.25	1.28	1.22	1.25	1.28	V
DRVDD	Full	1.22	1.25	1.28	1.22	1.25	1.28	V
SPIVDD	Full	1.7	1.8	3.4	1.7	1.8	3.4	V
I_{AVDD1}	Full	245		286	370		409	mA
I_{AVDD2}	Full	279		343	370		456	mA
I_{AVDD3}	Full	61		75	83		100	mA
I_{AVDD1_SR}	Full	16		18	15		18	mA
I_{DVDD}^1	Full	73		107	129		159	mA
I_{DRVDD}^1	Full	109		181	147		175	mA
I_{SPIVDD}	Full	5		6	5		6	mA
POWER CONSUMPTION								
Total Power Dissipation (Including Output Drivers) ¹	Full	1.5			2.0			W
Power-Down Dissipation	Full	600			700			mW
Standby ²	Full	900			1100			mW

¹ Default mode. No DDCs used. 500 MSPS is L = 2, M = 1, and F = 1; 1000 MSPS is L = 4, M = 1, and F = 1. Power dissipation on DRVDD changes with lane rate and number of lanes used. Care must be taken to ensure that the serial line rate for a given configuration is within the supported range of 3.125 Gbps to 12.5 Gbps.

² Can be controlled by the SPI.

AC SPECIFICATIONS

AVDD1 = 1.25 V, AVDD2 = 2.5 V, AVDD3 = 3.3 V, AVDD1_SR = 1.25 V, DVDD = 1.25 V, DRVDD = 1.25 V, SPIVDD = 1.8 V, specified maximum sampling rate for each speed grade, $A_{IN} = -1.0$ dBFS, clock divider = 2, default SPI settings, $T_A = 25^\circ\text{C}$, unless otherwise noted.

Table 2.

Parameter ¹	Temperature	AD9690-500			AD9690-1000			Unit
		Min	Typ	Max	Min	Typ	Max	
ANALOG INPUT FULL SCALE	Full	2.06			1.7			V p-p
NOISE DENSITY ²	Full	-153			-154			dBFS/Hz
SIGNAL-TO-NOISE RATIO (SNR) ³								
$f_{IN} = 10$ MHz	25°C		69.2		67.2		dBFS	
$f_{IN} = 170$ MHz	Full	67.8	69.0		65.1	66.6	dBFS	
$f_{IN} = 340$ MHz	25°C		68.6		65.3		dBFS	
$f_{IN} = 450$ MHz	25°C		68.0		64.0		dBFS	
$f_{IN} = 765$ MHz	25°C		64.4		61.5		dBFS	
$f_{IN} = 985$ MHz	25°C		63.8		60.5		dBFS	
$f_{IN} = 1950$ MHz	25°C		60.5		57.0		dBFS	
SNR AND DISTORTION RATIO (SINAD) ³								
$f_{IN} = 10$ MHz	25°C		69.0		67.1		dBFS	
$f_{IN} = 170$ MHz	Full	66.6	68.8		65.0	66.4	dBFS	
$f_{IN} = 340$ MHz	25°C		68.4		65.2		dBFS	
$f_{IN} = 450$ MHz	25°C		67.9		63.8		dBFS	
$f_{IN} = 765$ MHz	25°C		64.2		62.1		dBFS	
$f_{IN} = 985$ MHz	25°C		63.6		61.1		dBFS	
$f_{IN} = 1950$ MHz	25°C		60.3		56.0		dBFS	
EFFECTIVE NUMBER OF BITS (ENOB)								
$f_{IN} = 10$ MHz	25°C		11.2		10.8		Bits	
$f_{IN} = 170$ MHz	Full	10.8	11.1		10.5	10.7	Bits	
$f_{IN} = 340$ MHz	25°C		11.1		10.5		Bits	
$f_{IN} = 450$ MHz	25°C		11.0		10.3		Bits	
$f_{IN} = 765$ MHz	25°C		10.4		10.0		Bits	
$f_{IN} = 985$ MHz	25°C		10.3		9.8		Bits	
$f_{IN} = 1950$ MHz	25°C		9.7		9.0		Bits	
SPURIOUS-FREE DYNAMIC RANGE (SFDR) ³								
$f_{IN} = 10$ MHz	25°C		83		88		dBFS	
$f_{IN} = 170$ MHz	Full	80	88		75	85	dBFS	
$f_{IN} = 340$ MHz	25°C		83		85		dBFS	
$f_{IN} = 450$ MHz	25°C		81		82		dBFS	
$f_{IN} = 765$ MHz	25°C		80		82		dBFS	
$f_{IN} = 985$ MHz	25°C		75		80		dBFS	
$f_{IN} = 1950$ MHz	25°C		70		68		dBFS	
WORST HARMONIC, SECOND OR THIRD ³								
$f_{IN} = 10$ MHz	25°C		-83		-88		dBFS	
$f_{IN} = 170$ MHz	Full		-88	-75	-85	-75	dBFS	
$f_{IN} = 340$ MHz	25°C		-83		-85		dBFS	
$f_{IN} = 450$ MHz	25°C		-81		-82		dBFS	
$f_{IN} = 765$ MHz	25°C		-80		-82		dBFS	
$f_{IN} = 985$ MHz	25°C		-75		-80		dBFS	
$f_{IN} = 1950$ MHz	25°C		-70		-68		dBFS	

Parameter ¹	Temperature	AD9690-500			AD9690-1000			Unit
		Min	Typ	Max	Min	Typ	Max	
WORST OTHER, EXCLUDING SECOND OR THIRD HARMONIC ³								
$f_{IN} = 10$ MHz	25°C		-95			-95		dBFS
$f_{IN} = 170$ MHz	Full		-95	-82		-94	-81	dBFS
$f_{IN} = 340$ MHz	25°C		-93			-88		dBFS
$f_{IN} = 450$ MHz	25°C		-93			-86		dBFS
$f_{IN} = 765$ MHz	25°C		-88			-81		dBFS
$f_{IN} = 985$ MHz	25°C		-89			-82		dBFS
$f_{IN} = 1950$ MHz	25°C		-84			-75		dBFS
TWO-TONE INTERMODULATION DISTORTION (IMD), A_{IN1} AND $A_{IN2} = -7$ dBFS								
$f_{IN1} = 185$ MHz, $f_{IN2} = 188$ MHz	25°C		-88			-87		dBFS
$f_{IN1} = 338$ MHz, $f_{IN2} = 341$ MHz	25°C		-88			-88		dBFS
FULL POWER BANDWIDTH ⁴	25°C		2			2		GHz

¹ See the [AN-835 Application Note](#), *Understanding High Speed ADC Testing and Evaluation*, for definitions and for details on how these tests were completed.

² Noise density is measured at a low analog input frequency (30 MHz).

³ See Table 10 for the recommended settings for full-scale voltage and buffer current.

⁴ Measured with the circuit shown in Figure 64.

DIGITAL SPECIFICATIONS

AVDD1 = 1.25 V, AVDD2 = 2.5 V, AVDD3 = 3.3 V, AVDD1_SR = 1.25 V, DVDD = 1.25 V, DRVDD = 1.25 V, SPIVDD = 1.8 V, specified maximum sampling rate for each speed grade, $A_{IN} = -1.0$ dBFS, clock divider = 2, default SPI settings, $T_A = 25^\circ\text{C}$, unless otherwise noted.

Table 3.

Parameter	Temperature	Min	Typ	Max	Unit
CLOCK INPUTS (CLK+, CLK-)					
Logic Compliance	Full		LVDS/LVPECL		
Differential Input Voltage	Full	600	1200	1800	mV p-p
Input Common-Mode Voltage	Full		0.85		V
Input Resistance (Differential)	Full		35		k Ω
Input Capacitance	Full			2.5	pF
SYSREF INPUTS (SYSREF+, SYSREF-)					
Logic Compliance	Full		LVDS/LVPECL		
Differential Input Voltage	Full	400	1200	1800	mV p-p
Input Common-Mode Voltage	Full	0.6	0.85	2.0	V
Input Resistance (Differential)	Full		35		k Ω
Input Capacitance (Differential)	Full			2.5	pF
LOGIC INPUTS (SDI, SCLK, CSB, PDWN/STBY)					
Logic Compliance	Full		CMOS		
Logic 1 Voltage	Full		$0.8 \times \text{SPIVDD}$		V
Logic 0 Voltage	Full	0	$0.2 \times \text{SPIVDD}$		V
Input Resistance	Full		30		k Ω
LOGIC OUTPUT (SDIO)					
Logic Compliance	Full		CMOS		
Logic 1 Voltage ($I_{OH} = 800 \mu\text{A}$)	Full		$0.8 \times \text{SPIVDD}$		V
Logic 0 Voltage ($I_{OL} = 50 \mu\text{A}$)	Full		$0.2 \times \text{SPIVDD}$		V
SYNCIN INPUT (SYNCINB+/SYNCINB-)					
Logic Compliance	Full		LVDS/LVPECL/CMOS		
Differential Input Voltage	Full	400	1200	1800	mV p-p
Input Common-Mode Voltage	Full	0.6	0.85	2.0	V
Input Resistance (Differential)	Full		35		k Ω
Input Capacitance	Full			2.5	pF

Parameter	Temperature	Min	Typ	Max	Unit
LOGIC OUTPUT (FD)					
Logic Compliance	Full		CMOS		
Logic 1 Voltage	Full	0.8	SPIVDD		V
Logic 0 Voltage	Full	0	0		V
Input Resistance	Full		30		k Ω
DIGITAL OUTPUTS (SERDOUT _{X±} , X = 0 TO 3)					
Logic Compliance	Full		CML		
Differential Output Voltage	Full	360		770	mV p-p
Output Common-Mode Voltage (V _{CM})					
AC Coupled	25°C	0		1.8	V
Short-Circuit Current (I _{DSHORT})	25°C	-100		+100	mA
Differential Return Loss (RL _{DIFF}) ¹	25°C	8			dB
Common-Mode Return Loss (RL _{CM}) ¹	25°C	6			dB
Differential Termination Impedance	Full	80	100	120	Ω

¹ Differential and common-mode return loss is measured from 100 MHz to 0.75 MHz \times baud rate.

SWITCHING SPECIFICATIONS

AVDD1 = 1.25 V, AVDD2 = 2.5 V, AVDD3 = 3.3 V, AVDD1_SR = 1.25 V, DVDD = 1.25 V, DRVDD = 1.25 V, SPIVDD = 1.8 V, specified maximum sampling rate for each speed grade, A_{IN} = -1.0 dBFS, default SPI settings, T_A = 25°C, unless otherwise noted.

Table 4.

Parameter	Temperature	AD9690-500			AD9690-1000			Unit
		Min	Typ	Max	Min	Typ	Max	
CLOCK								
Clock Rate (at CLK+/CLK- Pins)	Full	0.3		4	0.3		4	GHz
Maximum Sample Rate ¹	Full	500			1000			MSPS
Minimum Sample Rate ²	Full	300			300			MSPS
Clock Pulse Width High	Full	1000			500			ps
Clock Pulse Width Low	Full	1000			500			ps
OUTPUT PARAMETERS								
Unit Interval (UI) ³	Full	80	200		80	100		ps
Rise Time (t _R) (20% to 80% into 100 Ω Load)	25°C	24	32		24	32		ps
Fall Time (t _F) (20% to 80% into 100 Ω Load)	25°C	24	32		24	32		ps
PLL Lock Time	25°C		2			2		ms
Data Rate (NRZ) ⁴	25°C	3.125	5	12.5	3.125	10	12.5	Gbps
LATENCY ⁵								
Pipeline Latency	Full		55			55		Clock cycles
Fast Detect Latency	Full			28			28	Clock cycles
Wake-Up Time ⁶								
Standby	25°C		1			1		ms
Power-Down	25°C			4			4	ms
APERTURE								
Aperture Delay (t _A)	Full		530			530		ps
Aperture Uncertainty (Jitter, t _J)	Full		55			55		fs rms
Out-of-range Recovery Time	Full		1			1		Clock Cycles

¹ The maximum sample rate is the clock rate after the divider.

² The minimum sample rate operates at 300 MSPS with L = 2 or L = 1.

³ Baud rate = 1/UI. A subset of this range can be supported.

⁴ Default L = 4. This number can be changed based on the sample rate and decimation ratio.

⁵ No DDCs used. L = 2, M = 1, F = 1.

⁶ Wake-up time is defined as the time required to return to normal operation from power-down mode.

TIMING SPECIFICATIONS

Table 5.

Parameter	Test Conditions/Comments	Min	Typ	Max	Unit
CLK+ to SYSREF+ TIMING REQUIREMENTS					
t_{SU_SR}	Device clock to SYSREF+ setup time		117		ps
t_{H_SR}	Device clock to SYSREF+ hold time		-96		ps
SPI TIMING REQUIREMENTS					
t_{DS}	Setup time between the data and the rising edge of SCLK	2			ns
t_{DH}	Hold time between the data and the rising edge of SCLK	2			ns
t_{CLK}	Period of the SCLK	40			ns
t_S	Setup time between CSB and SCLK	2			ns
t_H	Hold time between CSB and SCLK	2			ns
t_{HIGH}	Minimum period that SCLK must be in a logic high state	10			ns
t_{LOW}	Minimum period that SCLK must be in a logic low state	10			ns
t_{EN_SDIO}	Time required for the SDIO pin to switch from an input to an output relative to the SCLK falling edge (not shown in Figure 4)	10			ns
t_{DIS_SDIO}	Time required for the SDIO pin to switch from an output to an input relative to the SCLK rising edge (not shown in Figure 4)	10			ns

Timing Diagrams

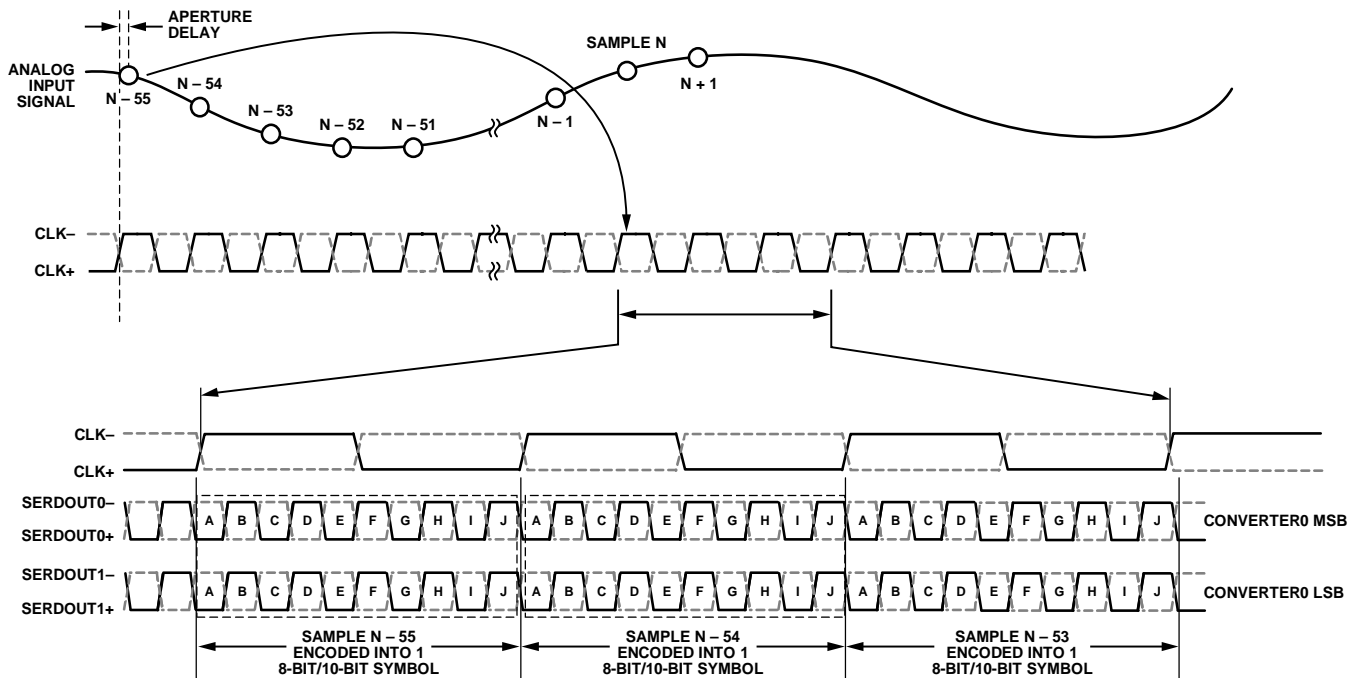

Figure 2. Data Output Timing (Full Bandwidth Mode; L = 2; M = 1; F = 1)

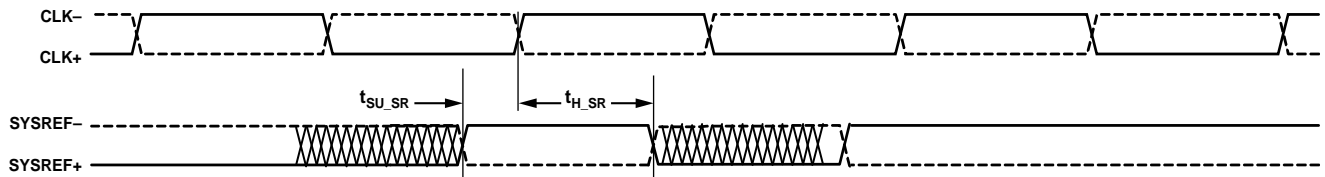

Figure 3. SYSREF± Setup and Hold Timing

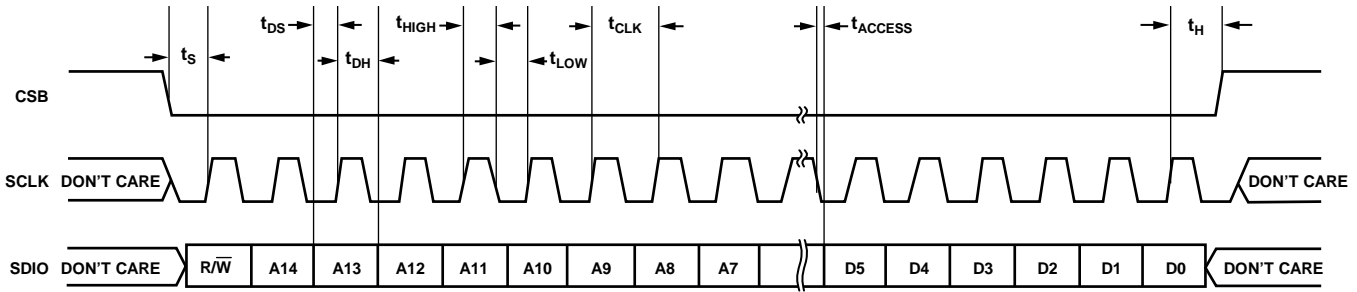

Figure 4. Serial Port Interface Timing Diagram

12834-004

ABSOLUTE MAXIMUM RATINGS

Table 6.

Parameter	Rating
Electrical	
AVDD1 to AGND	1.32 V
AVDD1_SR to AGND	1.32 V
AVDD2 to AGND	2.75 V
AVDD3 to AGND	3.63 V
DVDD to DGND	1.32 V
DRVDD to DRGND	1.32 V
SPIVDD to AGND	3.63 V
AGND to DRGND	-0.3 V to +0.3 V
VIN± to AGND	3.2 V
SCLK, SDIO, CSB to AGND	-0.3 V to SPIVDD + 0.3 V
PDWN/STBY to AGND	-0.3 V to SPIVDD + 0.3 V
Environmental	
Operating Temperature Range	-40°C to +85°C
Junction Temperature Range	-40°C to +125°C
Storage Temperature Range (Ambient)	-65°C to +150°C

Stresses at or above those listed under Absolute Maximum Ratings may cause permanent damage to the product. This is a stress rating only; functional operation of the product at these or any other conditions above those indicated in the operational section of this specification is not implied. Operation beyond the maximum operating conditions for extended periods may affect product reliability.

THERMAL CHARACTERISTICS

Typical θ_{JA} , θ_{JB} , and θ_{JC} are specified vs. the number of printed circuit board (PCB) layers in different airflow velocities (in m/sec). Airflow increases heat dissipation effectively reducing θ_{JA} and θ_{JB} . In addition, metal in direct contact with the package leads and exposed pad from metal traces, through holes, ground, and power planes, reduces θ_{JA} . Thermal performance for actual applications requires careful inspection of the conditions in an application. The use of appropriate thermal management techniques is recommended to ensure that the maximum junction temperature does not exceed the limits shown in Table 6.

Table 7. Thermal Resistance Values

PCB Type	Airflow Velocity (m/sec)	θ_{JA}	Ψ_{JB}	θ_{JC_TOP}	θ_{JC_BOT}	Unit
JEDEC	0.0	17.8 ^{1,2}	6.3 ^{1,3}	4.7 ^{1,4}	1.2 ^{1,4}	°C/W
2s2p	1.0	15.6 ^{1,2}	5.9 ^{1,3}	N/A ⁵		°C/W
Board	2.5	15.0 ^{1,2}	5.7 ^{1,3}	N/A ⁵		°C/W

¹ Per JEDEC 51-7, plus JEDEC 51-5 2s2p test board.

² Per JEDEC JESD51-2 (still air) or JEDEC JESD51-6 (moving air).

³ Per JEDEC JESD51-8 (still air).

⁴ Per MIL-STD 883, Method 1012.1.

⁵ N/A means not applicable.

ESD CAUTION



ESD (electrostatic discharge) sensitive device. Charged devices and circuit boards can discharge without detection. Although this product features patented or proprietary protection circuitry, damage may occur on devices subjected to high energy ESD. Therefore, proper ESD precautions should be taken to avoid performance degradation or loss of functionality.

PIN CONFIGURATION AND FUNCTION DESCRIPTIONS

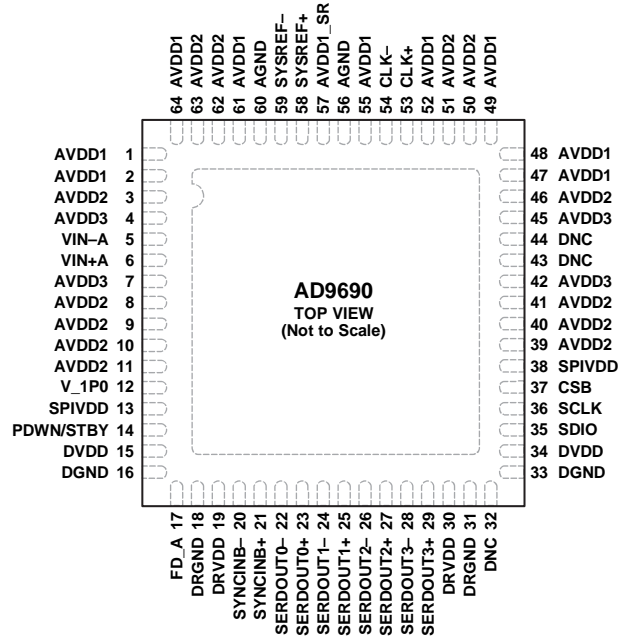

- NOTES**
1. EXPOSED PAD. THE EXPOSED THERMAL PAD ON THE BOTTOM OF THE PACKAGE PROVIDES THE GROUND REFERENCE FOR AVDDx. THIS EXPOSED PAD MUST BE CONNECTED TO GROUND FOR PROPER OPERATION.
 2. DNC = DO NOT CONNECT.

12834-005

Figure 5. Pin Configuration (Top View)

Table 8. Pin Function Descriptions

Pin No.	Mnemonic	Type	Description
Power Supplies			
0	EPAD	Ground	Exposed Pad. The exposed thermal pad on the bottom of the package provides the ground reference for AVDDx. This exposed pad must be connected to ground for proper operation.
1, 2, 47, 48, 49, 52, 55, 61, 64	AVDD1	Supply	Analog Power Supply (1.25 V Nominal).
3, 8, 9, 10, 11, 39, 40, 41, 46, 50, 51, 62, 63	AVDD2	Supply	Analog Power Supply (2.5 V Nominal).
4, 7, 42, 45	AVDD3	Supply	Analog Power Supply (3.3 V Nominal).
13, 38	SPIVDD	Supply	Digital Power Supply for SPI (1.8 V to 3.3 V).
15, 34	DVDD	Supply	Digital Power Supply (1.25 V Nominal).
16, 33	DGND	Ground	Ground Reference for DVDD.
18, 31	DRGND	Ground	Ground Reference for DRVDD.
19, 30	DRVDD	Supply	Digital Driver Power Supply (1.25 V Nominal).
56, 60	AGND ¹	Ground	Ground Reference for SYSREF±.
57	AVDD1_SR ¹	Supply	Analog Power Supply for SYSREF± (1.25 V Nominal).
Analog			
5, 6	VIN-, VIN+	Input	ADC Analog Input Complement/True.
12	V_1P0	Input/DNC	1.0 V Reference Voltage Input/Do Not Connect. This pin is configurable through the SPI as a no connect or an input. Do not connect this pin if using the internal reference. Requires a 1.0 V reference voltage input if using an external voltage reference source.
44, 43	DNC	DNC	Do Not Connect.
53, 54	CLK+, CLK-	Input	Clock Input True/Complement.

Pin No.	Mnemonic	Type	Description
CMOS Outputs 17 32	FD DNC	Output DNC	Fast Detect Output. Do Not Connect.
Digital Inputs 20, 21 58, 59	SYNCINB-, SYNCINB+ SYSREF+, SYSREF-	Input Input	Active Low JESD204B LVDS Sync Input True/Complement. Active High JESD204B LVDS System Reference Input True/Complement.
Data Outputs 22, 23 24, 25 26, 27 28, 29	SERDOUT0-, SERDOUT0+ SERDOUT1-, SERDOUT1+ SERDOUT2-, SERDOUT2+ SERDOUT3-, SERDOUT3+	Output Output Output Output	Lane 0 Output Data Complement/True. Lane 1 Output Data Complement/True. Lane 2 Output Data Complement/True. Lane 3 Output Data Complement/True.
Device Under Test (DUT) Controls 14 35 36 37	PDWN/STBY SDIO SCLK CSB	Input Input/Output Input Input	Power-Down Input (Active High). The operation of this pin depends on the SPI mode and can be configured as power-down or standby. SPI Serial Data Input/Output. SPI Serial Clock. SPI Chip Select (Active Low).

¹ To ensure proper ADC operation, connect AVDD1_SR and AGND separately from the AVDD1 and EPAD connection. For more information, refer to the Applications Information section.

TYPICAL PERFORMANCE CHARACTERISTICS

AD9690-1000

AVDD1 = 1.25 V, AVDD1_SR = 1.25 V, AVDD2 = 2.5 V, AVDD3 = 3.3 V, DVDD = 1.25 V, DRVDD = 1.25 V, SPIVDD = 1.8 V, 1.7 V p-p full-scale differential input, $A_{IN} = -1.0$ dBFS, default SPI settings, clock divider = 2, $T_A = 25^\circ\text{C}$, 128k FFT sample, unless otherwise noted. See Table 10 for recommended settings.

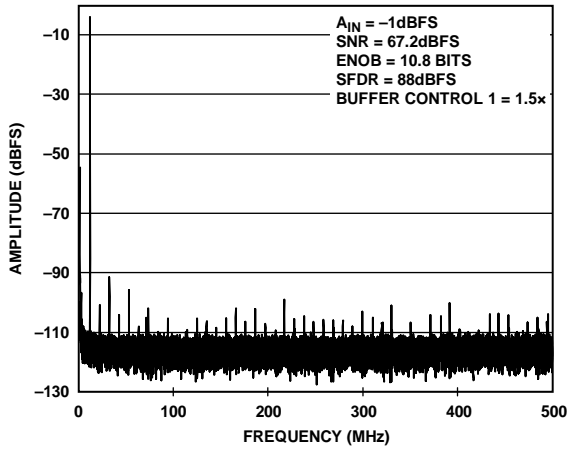

Figure 6. Single-Tone FFT with $f_{IN} = 10.3$ MHz

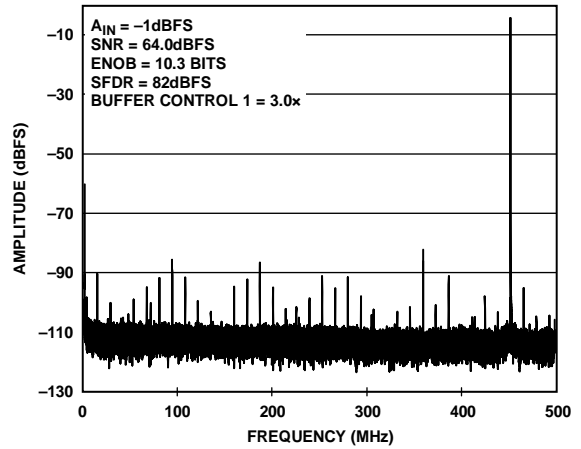

Figure 9. Single-Tone FFT with $f_{IN} = 450.3$ MHz

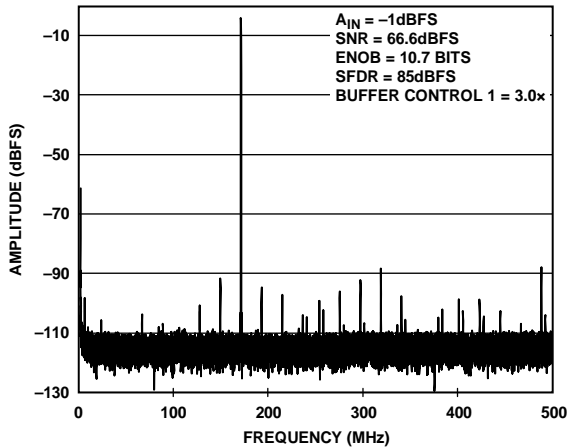

Figure 7. Single-Tone FFT with $f_{IN} = 170.3$ MHz

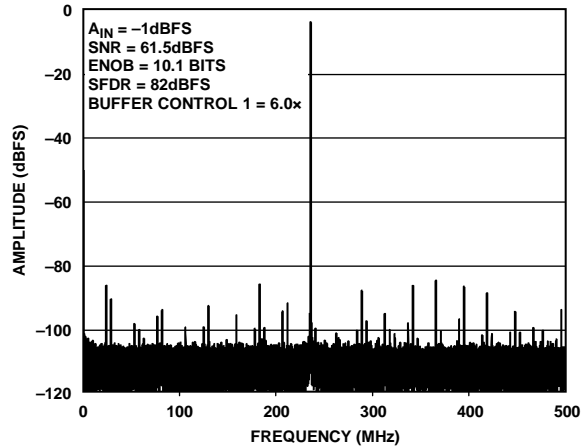

Figure 10. Single-Tone FFT with $f_{IN} = 765.3$ MHz

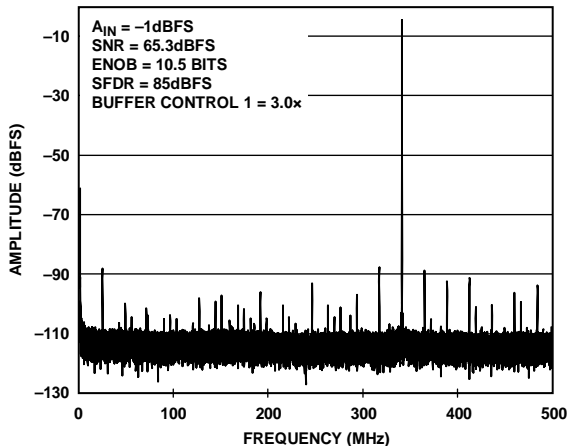

Figure 8. Single-Tone FFT with $f_{IN} = 340.3$ MHz

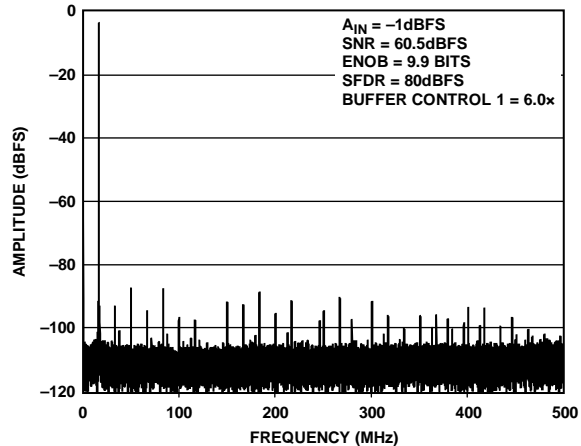

Figure 11. Single-Tone FFT with $f_{IN} = 985.3$ MHz

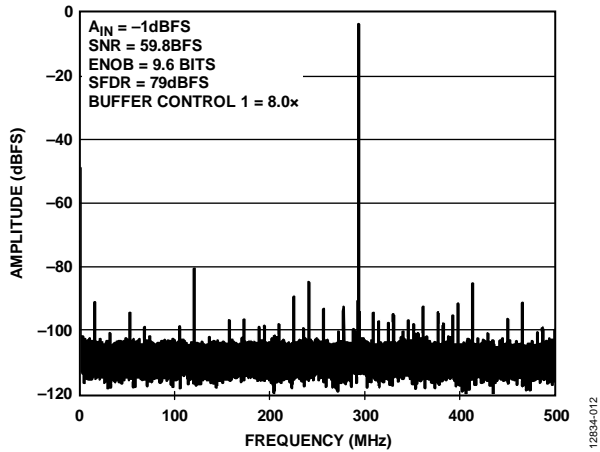

Figure 12. Single-Tone FFT with $f_{IN} = 1293.3$ MHz

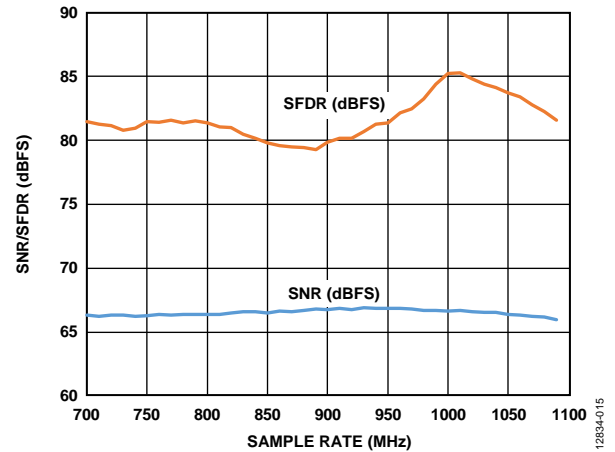

Figure 15. SNR/SFDR vs. Sample Rate (f_s), $f_{IN} = 170.3$ MHz; Buffer Control 1 (0x018) = 3.0x

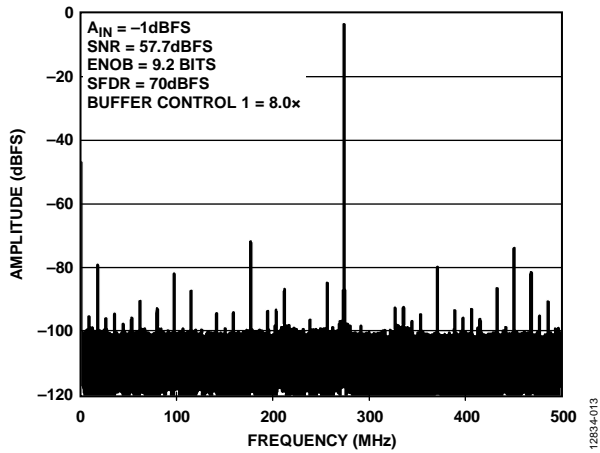

Figure 13. Single-Tone FFT with $f_{IN} = 1725.3$ MHz

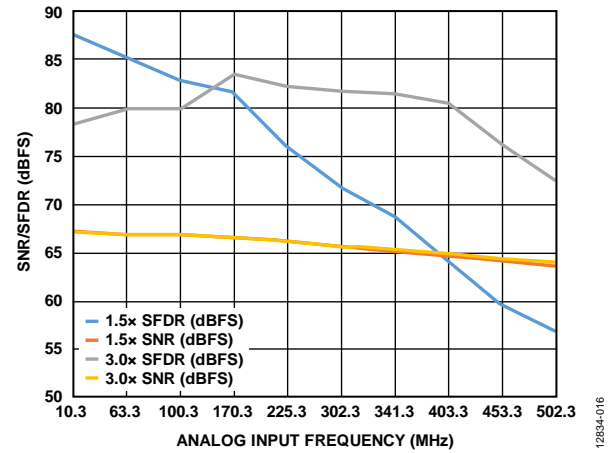

Figure 16. SNR/SFDR vs. Analog Input Frequency (f_{IN}); $f_{IN} < 500$ MHz; Buffer Control 1 (0x018) = 1.5x and 3.0x

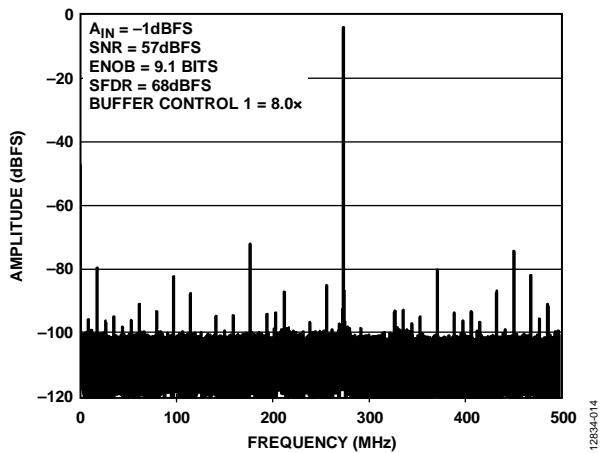

Figure 14. Single-Tone FFT with $f_{IN} = 1950.3$ MHz

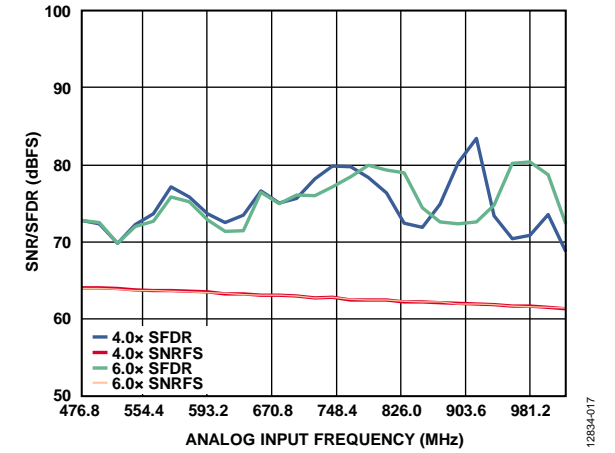

Figure 17. SNR/SFDR vs. Analog Input Frequency (f_{IN}); 500 MHz $< f_{IN} < 1$ GHz; Buffer Control 1 (0x018) = 4.0x and 6.0x

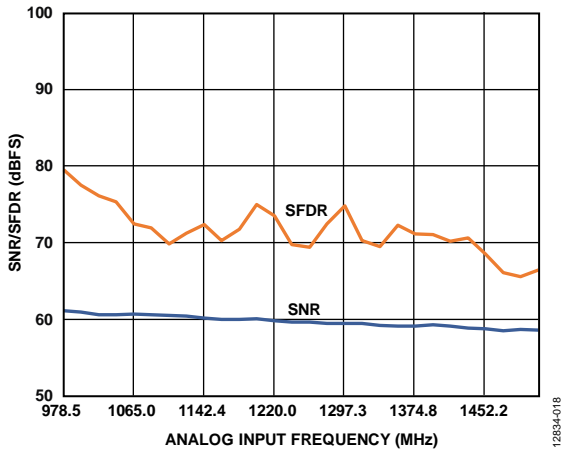

Figure 18. SNR/SFDR vs. f_{IN} ; $1\text{ GHz} < f_{IN} < 1.5\text{ GHz}$; Buffer Control 1 (0x018) = 6.0x

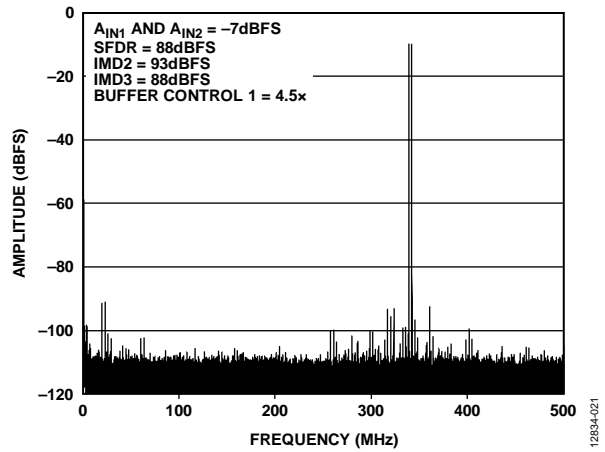

Figure 21. Two-Tone FFT; $f_{IN1} = 338\text{ MHz}$, $f_{IN2} = 341\text{ MHz}$

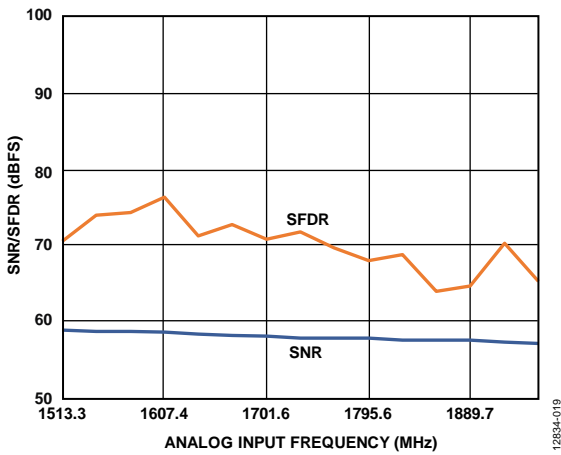

Figure 19. SNR/SFDR vs. f_{IN} ; $1.5\text{ GHz} < f_{IN} < 2\text{ GHz}$; Buffer Control 1 (0x018) = 7.5x

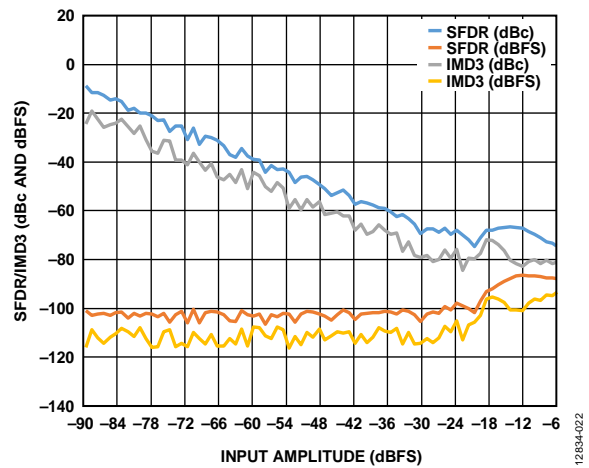

Figure 22. Two-Tone SFDR/IMD3 vs. Input Amplitude (A_{IN}) with $f_{IN1} = 184\text{ MHz}$ and $f_{IN2} = 187\text{ MHz}$

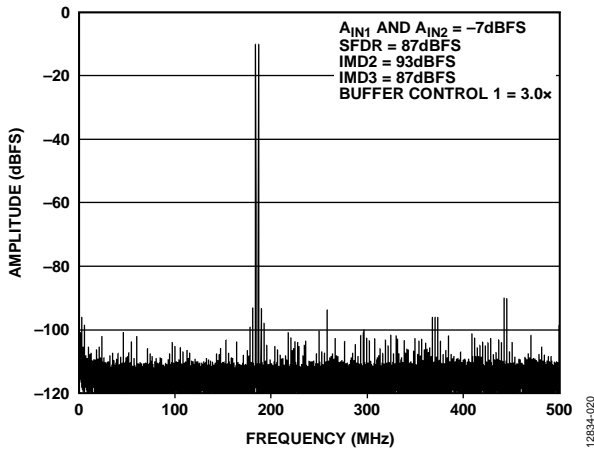

Figure 20. Two-Tone FFT; $f_{IN1} = 184\text{ MHz}$, $f_{IN2} = 187\text{ MHz}$

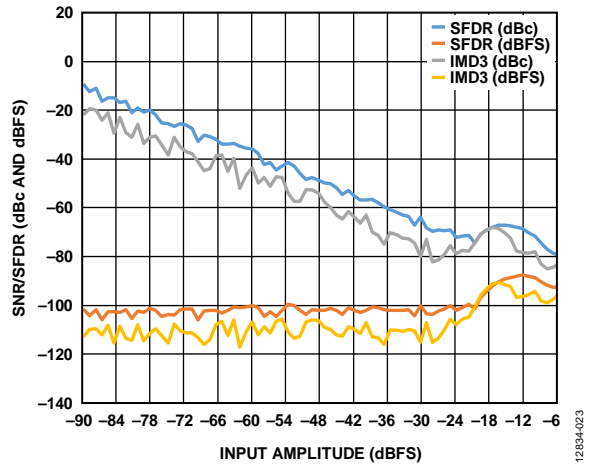

Figure 23. Two-Tone IMD3/SFDR vs. Input Amplitude (A_{IN}) with $f_{IN1} = 338\text{ MHz}$ and $f_{IN2} = 341\text{ MHz}$

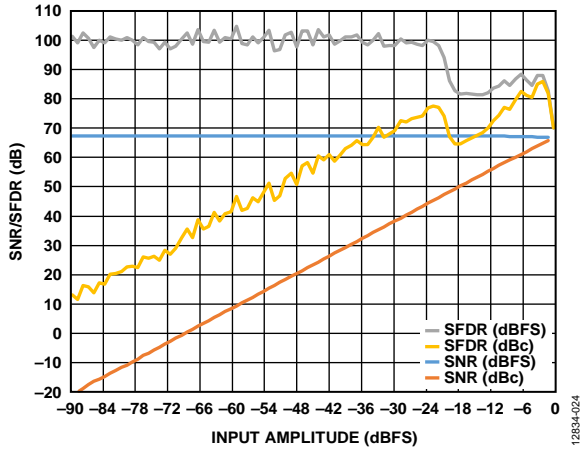

Figure 24. SNR/SFDR vs. Analog Input Level, $f_{IN} = 170.3$ MHz

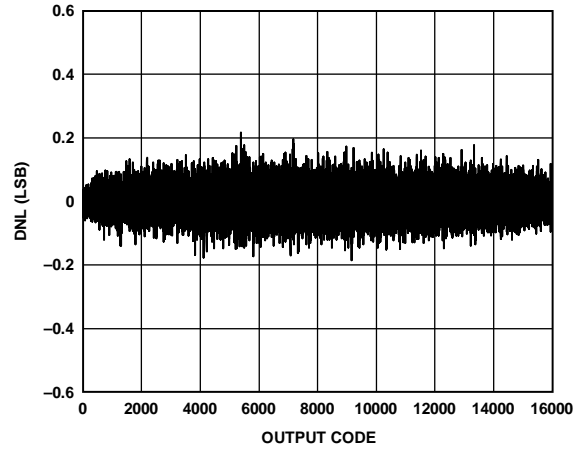

Figure 27. DNL, $f_{IN} = 15$ MHz

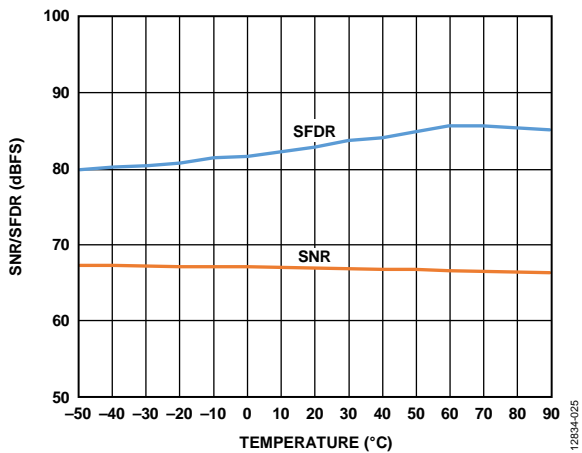

Figure 25. SNR/SFDR vs. Temperature, $f_{IN} = 170.3$ MHz

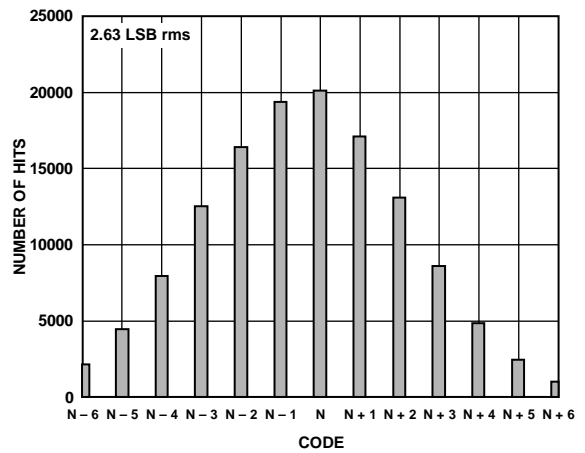

Figure 28. Input-Referred Noise Histogram

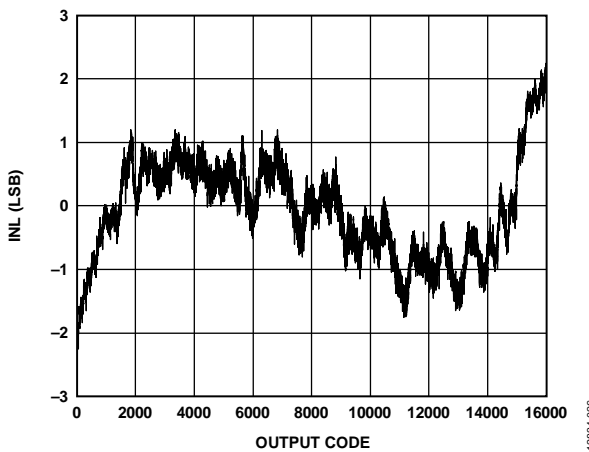

Figure 26. INL, $f_{IN} = 10.3$ MHz

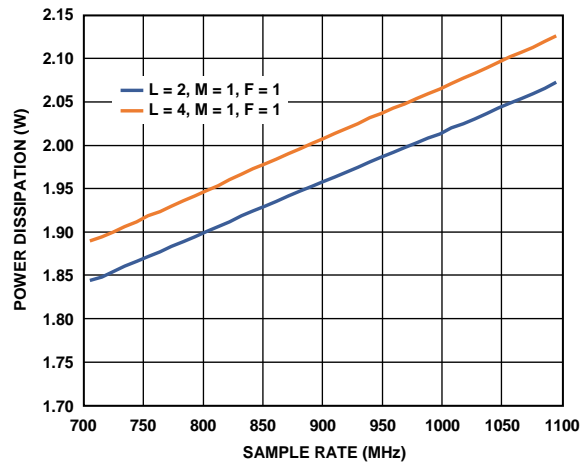

Figure 29. Power Dissipation vs. Sample Rate (f_s)

AD9690-500

AVDD1 = 1.25 V, AVDD1_SR = 1.25 V, AVDD2 = 2.5 V, AVDD3 = 3.3 V, DVDD = 1.25 V, DRVDD = 1.25 V, SPIVDD = 1.8 V, 2.06 V p-p full-scale differential input, $A_{IN} = -1.0$ dBFS, default SPI settings, clock divider = 2, $T_A = 25^\circ\text{C}$, 128k FFT sample, unless otherwise noted. See Table 10 for recommended settings.

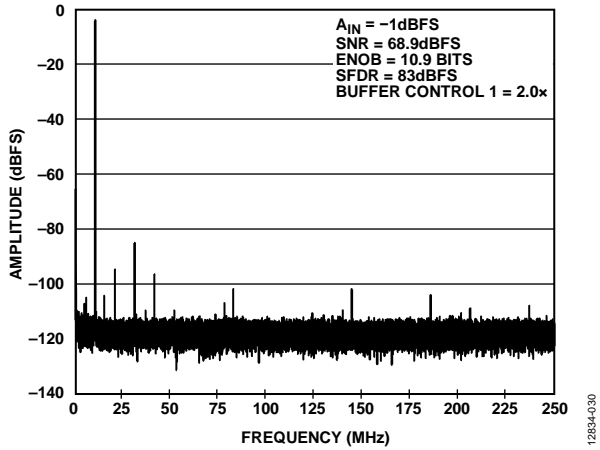

Figure 30. Single-Tone FFT with $f_{IN} = 10.3$ MHz

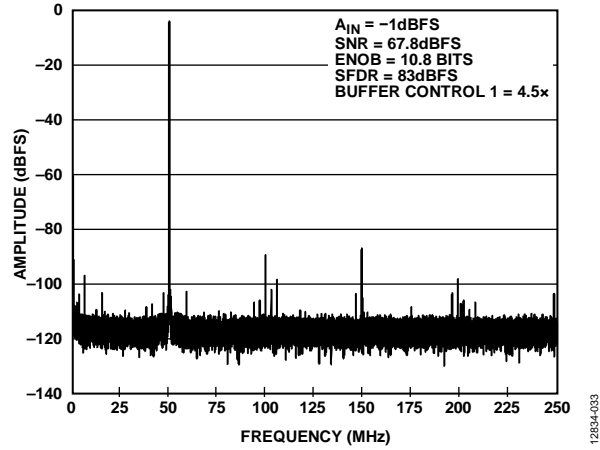

Figure 33. Single-Tone FFT with $f_{IN} = 450.3$ MHz

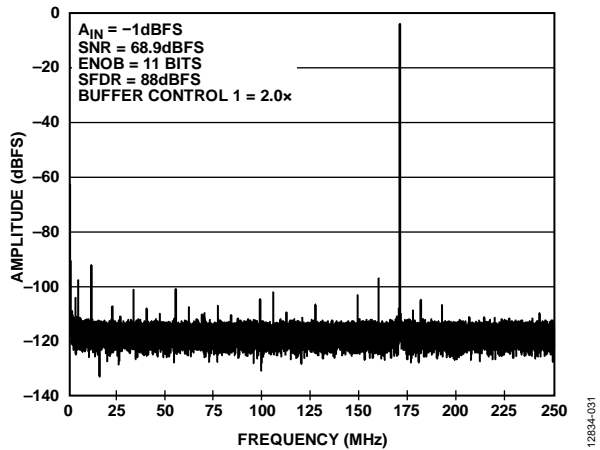

Figure 31. Single-Tone FFT with $f_{IN} = 170.3$ MHz

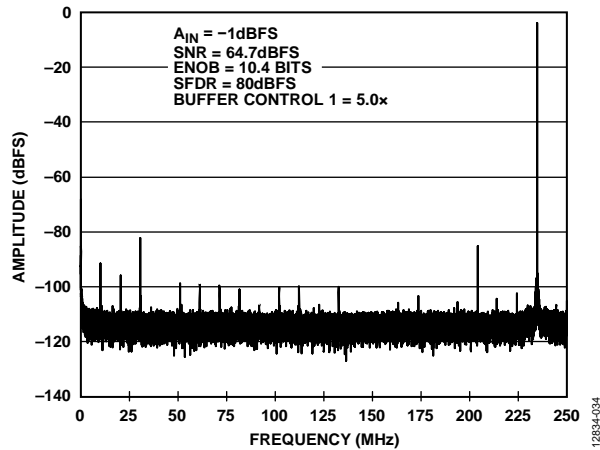

Figure 34. Single-Tone FFT with $f_{IN} = 765.3$ MHz

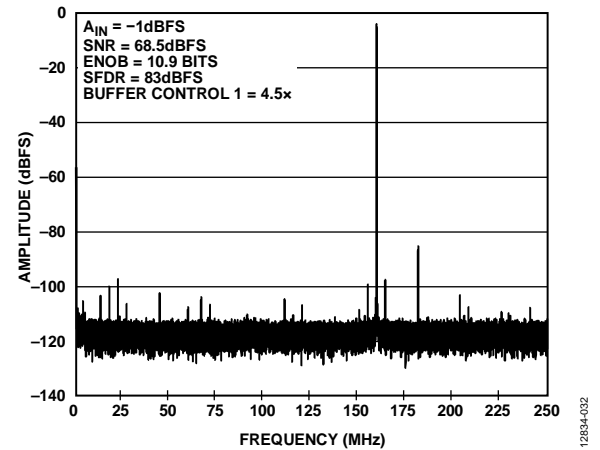

Figure 32. Single-Tone FFT with $f_{IN} = 340.3$ MHz

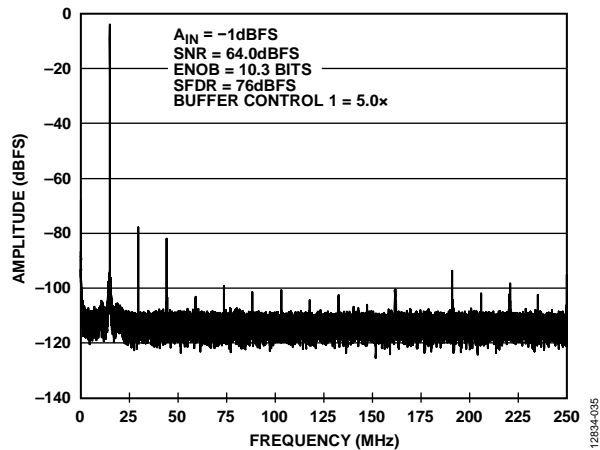

Figure 35. Single-Tone FFT with $f_{IN} = 985.3$ MHz

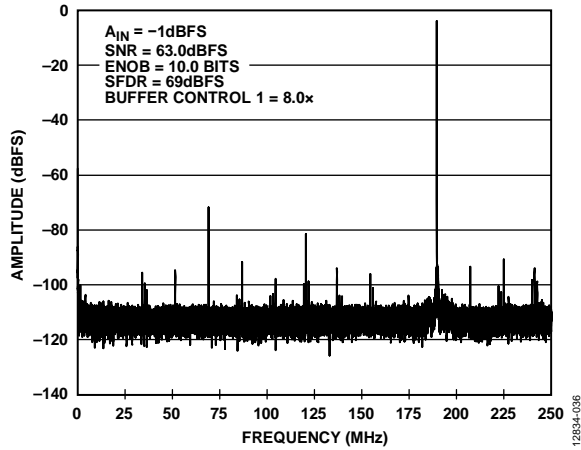

Figure 36. Single-Tone FFT with $f_{IN} = 1310.3$ MHz

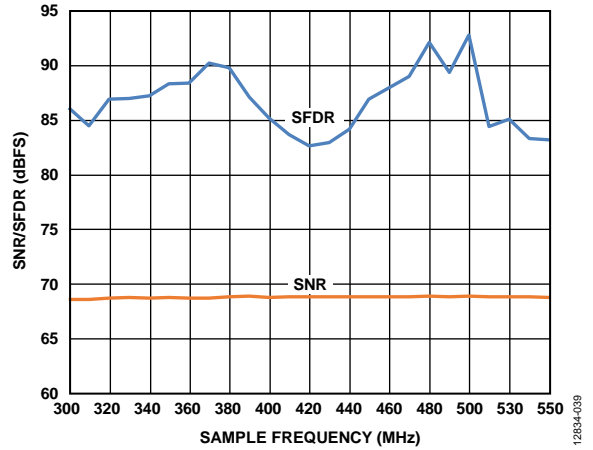

Figure 39. SNR/SFDR vs. f_s , $f_{IN} = 170.3$ MHz; Buffer Control 1 = 2.0x

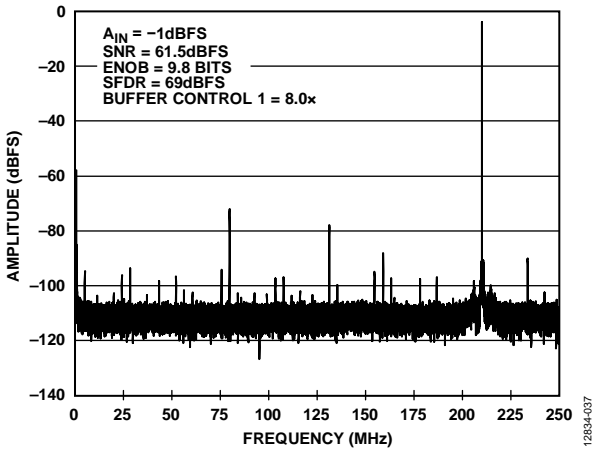

Figure 37. Single-Tone FFT with $f_{IN} = 1710.3$ MHz

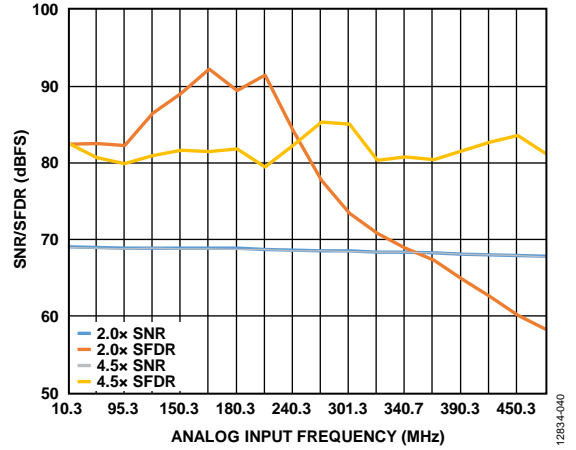

Figure 40. SNR/SFDR vs. f_{IN} ; $f_{IN} < 500$ MHz; Buffer Control 1 (0x018) = 2.0x and 4.5x

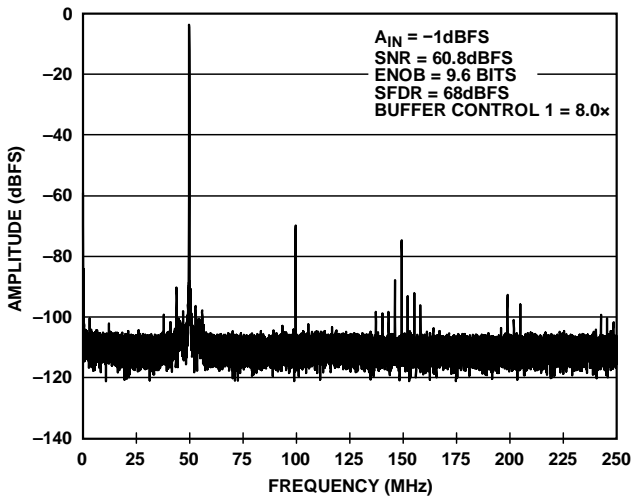

Figure 38. Single-Tone FFT with $f_{IN} = 1950.3$ MHz

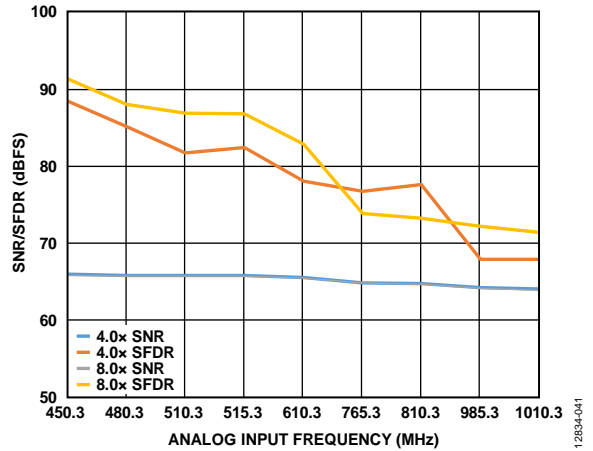

Figure 41. SNR/SFDR vs. f_{IN} ; 500 MHz $< f_{IN} < 1$ GHz; Buffer Control 1 (0x018) = 4.0x and 8.0x

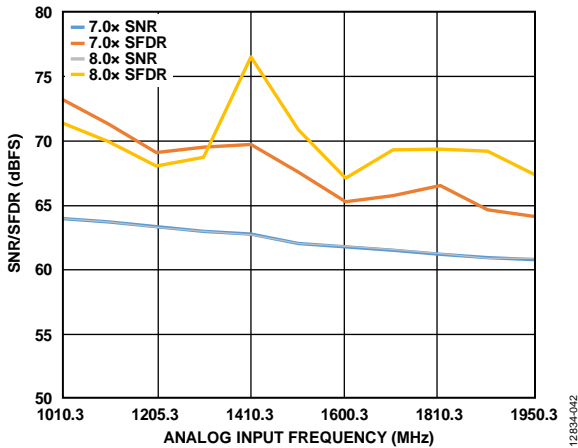

Figure 42. SNR/SFDR vs. f_{IN} ; $1\text{ GHz} < f_{IN} < 2\text{ GHz}$; Buffer Control 1 (0x018) = 7.0x and 8.0x

12834-042

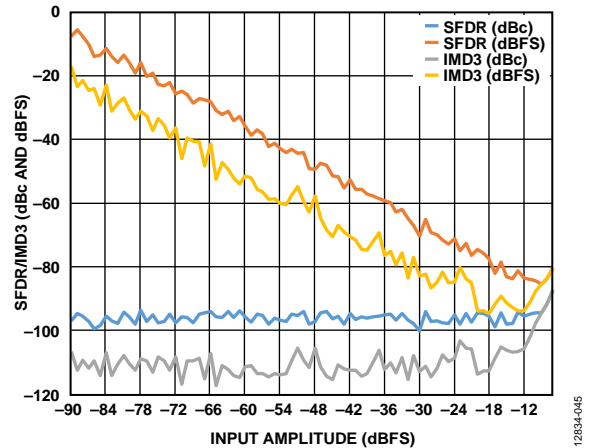

Figure 45. Two-Tone SFDR/IMD3 vs. Input Amplitude (A_{IN}) with $f_{IN1} = 184\text{ MHz}$ and $f_{IN2} = 187\text{ MHz}$

12834-045

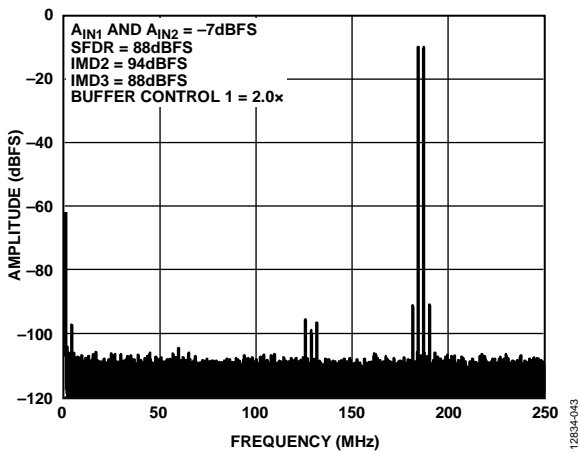

Figure 43. Two-Tone FFT; $f_{IN1} = 184\text{ MHz}$, $f_{IN2} = 187\text{ MHz}$

12834-043

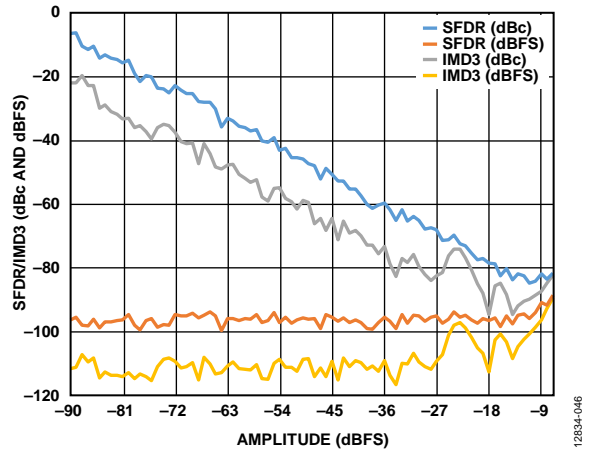

Figure 46. Two-Tone IMD3/SFDR vs. Input Amplitude (A_{IN}) with $f_{IN1} = 338\text{ MHz}$ and $f_{IN2} = 341\text{ MHz}$

12834-046

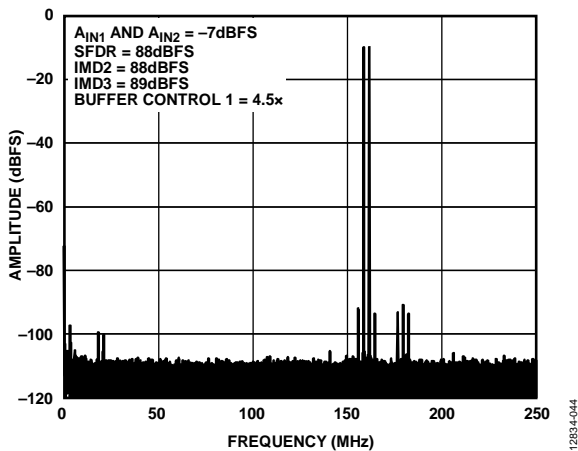

Figure 44. Two-Tone FFT; $f_{IN1} = 338\text{ MHz}$, $f_{IN2} = 341\text{ MHz}$

12834-044

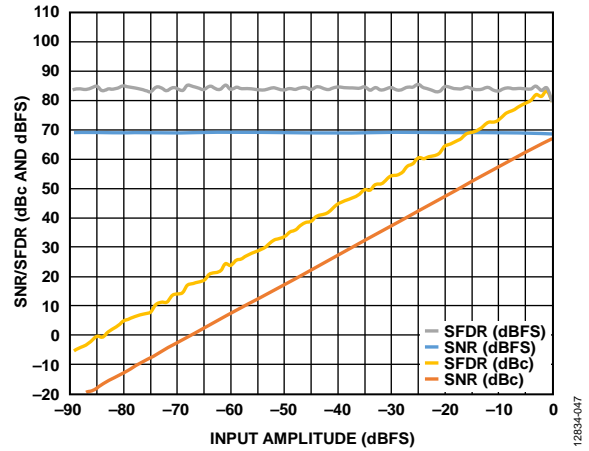

Figure 47. SNR/SFDR vs. Analog Input Level, $f_{IN} = 170.3\text{ MHz}$

12834-047

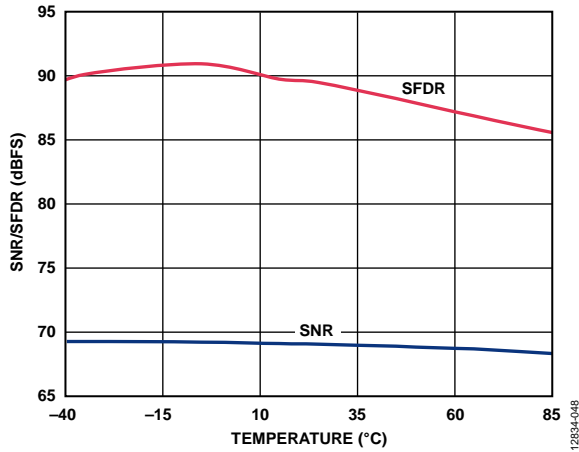

Figure 48. SNR/SFDR vs. Temperature, $f_{IN} = 170.3$ MHz

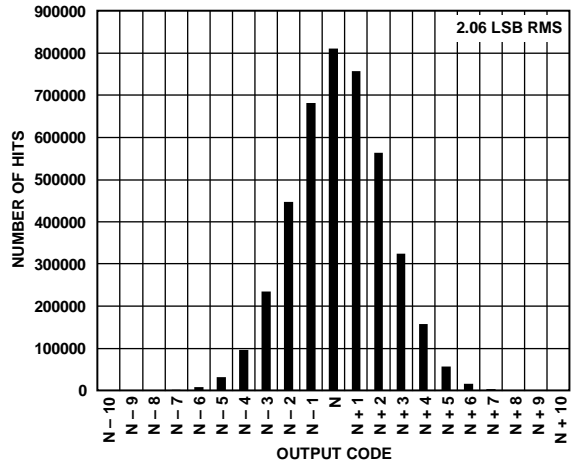

Figure 51. Input-Referred Noise Histogram

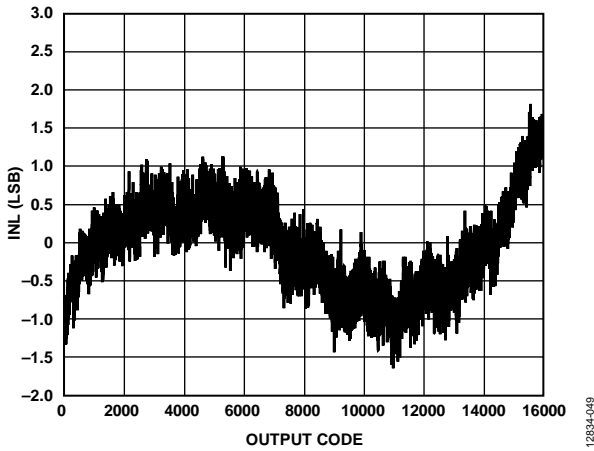

Figure 49. INL, $f_{IN} = 10.3$ MHz

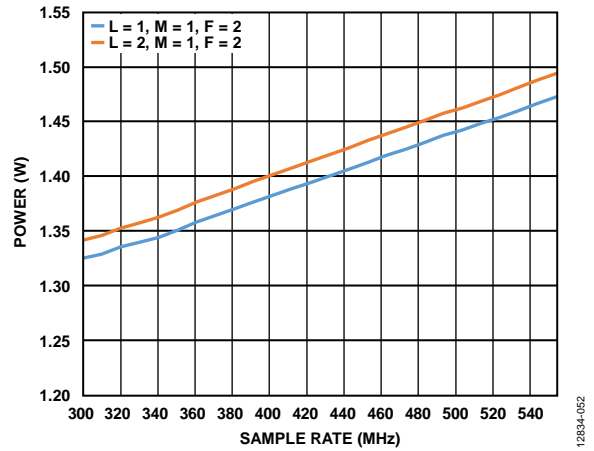

Figure 52. Power Dissipation vs. f_s

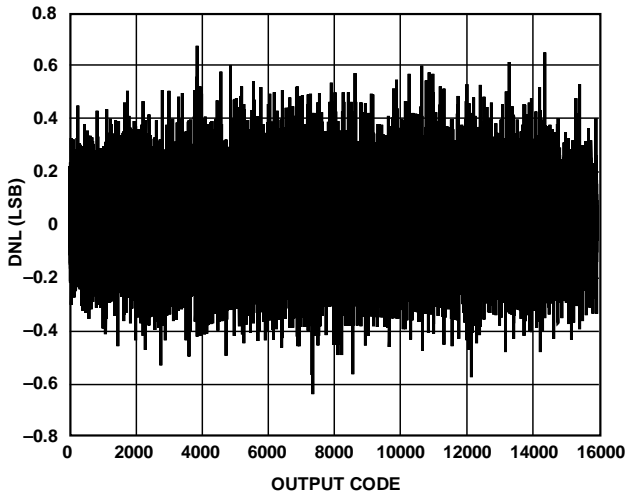

Figure 50. DNL, $f_{IN} = 15$ MHz

EQUIVALENT CIRCUITS

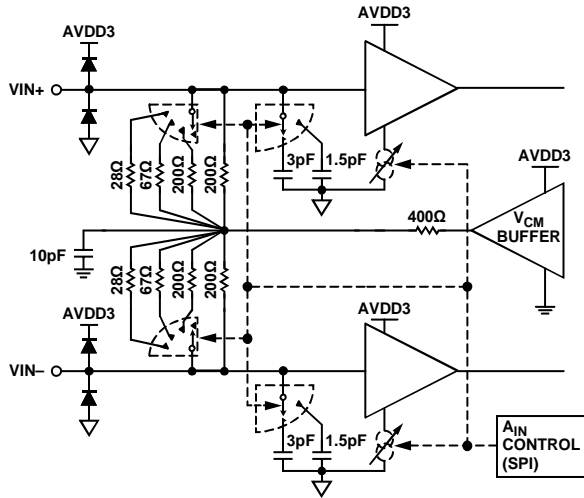

Figure 53. Analog Inputs

12834-053

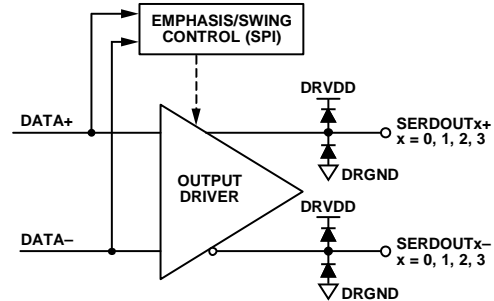

Figure 56. Digital Outputs

12834-056

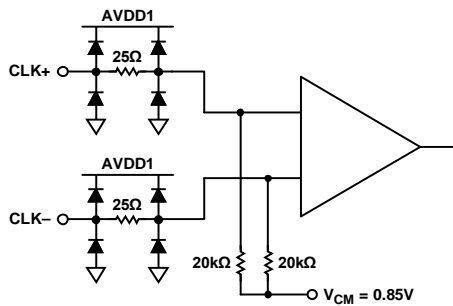

Figure 54. Clock Inputs

12834-054

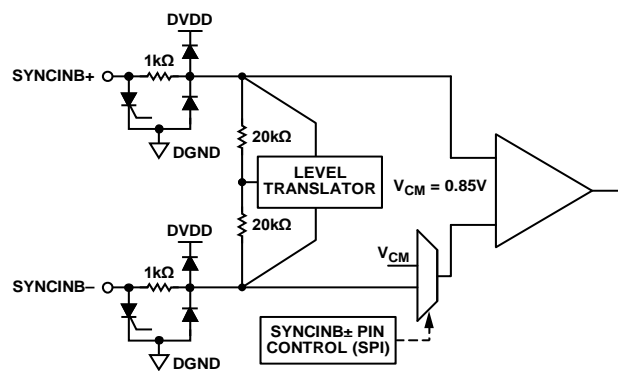

Figure 57. SYNCINB± Inputs

12834-057

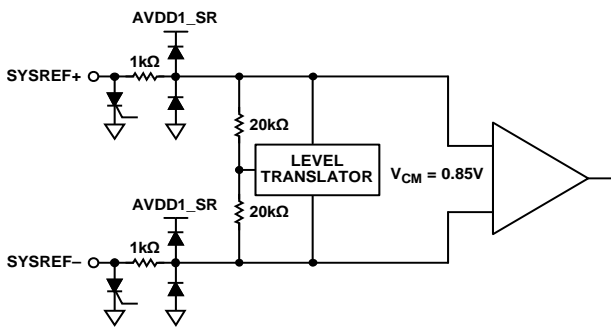

Figure 55. SYSREF± Inputs

12834-055

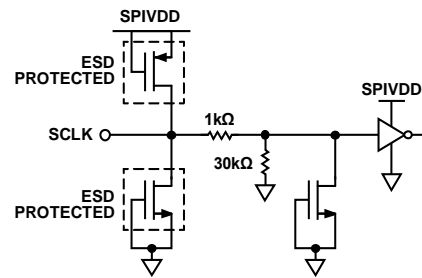
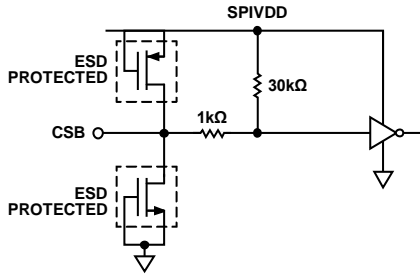

Figure 58. SCLK Input

12834-058



12834-059

Figure 59. CSB Input

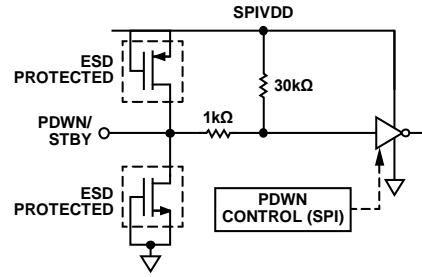

12834-062

Figure 62. PDWN/STBY Input

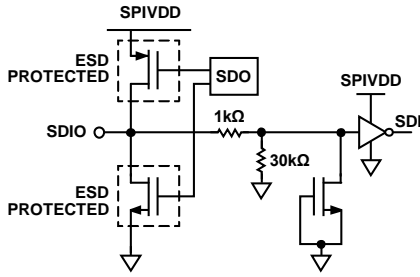

12834-060

Figure 60. SDIO Input

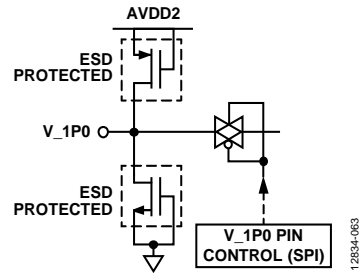

12834-063

Figure 63. V_1P0 Input/Output

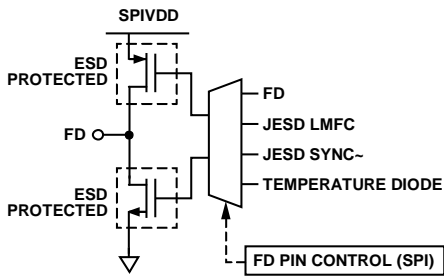

12834-061

Figure 61. FD Outputs

THEORY OF OPERATION

The [AD9690](#) has one analog input channel and two JESD204B output lane pairs. The ADC is designed to sample wide bandwidth analog signals of up to 2 GHz. The [AD9690](#) is optimized for wide input bandwidth, high sampling rate, excellent linearity, and low power in a small package.

The ADC core features a multistage, differential pipelined architecture with integrated output error correction logic. The ADC features a wide bandwidth input supporting a variety of user-selectable input ranges. An integrated voltage reference eases design considerations.

The [AD9690](#) has several functions that simplify the AGC function in a communications receiver. The programmable threshold detector allows monitoring of the incoming signal power using the fast detect output bit of the ADC. If the input signal level exceeds the programmable threshold, the fast detect indicator goes high. Because this threshold indicator has low latency, the user can quickly turn down the system gain to avoid an overrange condition at the ADC input.

The Subclass 1 JESD204B-based high speed serialized output data rate can be configured in one-lane ($L = 1$), two-lane ($L = 2$), and four-lane ($L = 4$) configurations, depending on the sample rate and the decimation ratio. Multiple device synchronization is supported through the $\text{SYSREF}\pm$ and $\text{SYNCINB}\pm$ input pins.

ADC ARCHITECTURE

The architecture of the [AD9690](#) consists of an input buffered pipelined ADC. The input buffer is designed to provide a termination impedance to the analog input signal. This termination impedance can be changed using the SPI to meet the termination needs of the driver/amplifier. The default termination value is set to 400 Ω . The equivalent circuit diagram of the analog input termination is shown in Figure 53. The input buffer is optimized for high linearity, low noise, and low power.

The input buffer provides a linear high input impedance (for ease of drive) and reduces kickback from the ADC. The buffer is optimized for high linearity, low noise, and low power. The quantized outputs from each stage are combined into a final 14-bit result in the digital correction logic. The pipelined architecture permits the first stage to operate with a new input sample; at the same time, the remaining stages operate with the preceding samples. Sampling occurs on the rising edge of the clock.

ANALOG INPUT CONSIDERATIONS

The analog input to the [AD9690](#) is a differential buffer. The internal common-mode voltage of the buffer is 2.05 V. The clock signal alternately switches the input circuit between sample mode and hold mode.

When the input circuit is switched into sample mode, the signal source must be capable of charging the sample capacitors and settling within one-half of a clock cycle. A small resistor, in series with each input, can help reduce the peak transient current injected from the output stage of the driving source. In addition, low Q inductors or ferrite beads can be placed on each leg of the input to reduce high differential capacitance at the analog inputs and, thus, achieve the maximum bandwidth of the ADC. Such use of low Q inductors or ferrite beads is required when driving the converter front end at high IF frequencies. Either a differential capacitor or two single-ended capacitors can be placed on the inputs to provide a matching passive network. This ultimately creates a low-pass filter at the input, which limits unwanted broadband noise. For more information, refer to the [AN-742 Application Note](#), the [AN-827 Application Note](#), and the *Analog Dialogue* article “[Transformer-Coupled Front-End for Wideband A/D Converters](#)” (Volume 39, April 2005). In general, the precise values depend on the application.

For best dynamic performance, the source impedances driving $\text{VIN}+$ and $\text{VIN}-$ must be matched such that common-mode settling errors are symmetrical. These errors are reduced by the common-mode rejection of the ADC. An internal reference buffer creates a differential reference that defines the span of the ADC core.

Maximum SNR performance is achieved by setting the ADC to the largest span in a differential configuration. In the case of the [AD9690](#), the available span is programmable through the SPI port from 1.46 V p-p to 2.06 V p-p differential, with 1.70 V p-p differential being the default for the [AD9690-1000](#) and 2.06 V p-p differential being the default for the [AD9690-500](#).

Differential Input Configurations

There are several ways to drive the [AD9690](#), either actively or passively. However, optimum performance is achieved by driving the analog input differentially.

For applications where SNR and SFDR are key parameters, differential transformer coupling is the recommended input configuration (see Figure 64 and Table 9) because the noise performance of most amplifiers is not adequate to achieve the true performance of the [AD9690](#).

For low to midrange frequencies, a double balun or double transformer network (see Figure 64 and Table 9) is recommended for optimum performance of the [AD9690](#). For higher frequencies in the second or third Nyquist zones, it is better to remove some of the front-end passive components to ensure wideband operation (see Figure 64 and Table 9).

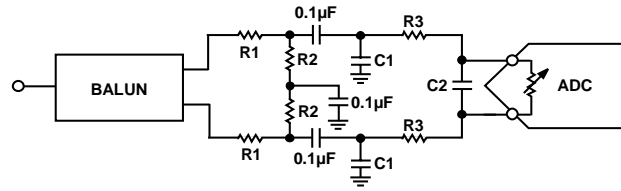

NOTES
1. SEE TABLE 9 FOR COMPONENT VALUES.

Figure 64. Differential Transformer-Coupled Configuration for the AD9690

Table 9. Differential Transformer-Coupled Input Configuration Component Values

Device	Frequency Range	Transformer	R1 (Ω)	R2 (Ω)	R3 (Ω)	C1 (pF)	C2 (pF)
AD9690-500	DC to 250 MHz	ETC1-1-13	10	50	10	4	2
	250 MHz to 2 GHz	BAL-0006/BAL-0006SMG	10	50	10	4	2
AD9690-1000	DC to 500 MHz	ECT1-1-13/BAL-0006SMG	25	25	10	4	2
	500 MHz to 2 GHz	BAL-0006/BAL-0006SMG	25	25	0	Open	Open

Input Common Mode

The analog inputs of the AD9690 are internally biased to the common mode as shown in Figure 65. The common-mode buffer has a limited range in that the performance suffers greatly if the common-mode voltage drops by more than 100 mV. Therefore, in dc-coupled applications, set the common-mode voltage to 2.05 V, ±100 mV to ensure proper ADC operation. The full-scale voltage setting must be at a 1.7 V p-p differential if running in a dc-coupled application.

Analog Input Buffer Controls and SFDR Optimization

The AD9690 input buffer offers flexible controls for the analog inputs, such as input termination, buffer current, and input full-scale adjustment. All the available controls are shown in Figure 65.

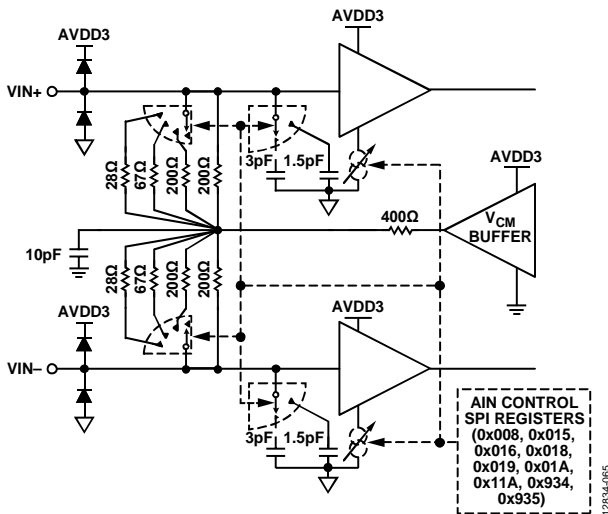

Figure 65. Analog Input Controls

Using the 0x018, 0x019, 0x01A, 0x11A, 0x934, and 0x935 registers, the buffer behavior on each channel can be adjusted to optimize the SFDR over various input frequencies and bandwidths of interest.

Input Buffer Control Registers (0x018, 0x019, 0x01A, 0x935, 0x934, 0x11A)

The input buffer has many registers that set the bias currents and other settings for operation at different frequencies. These bias currents and settings can be changed to suit the input frequency range of operation. Register 0x018 controls the buffer bias current to help with the kickback from the ADC core. This setting can be scaled from a low setting of 1.0x to a high setting of 8.5x. The default setting is 3.0x for the AD9690-1000, and 2.0x for the AD9690-500. These settings are sufficient for operation in the first Nyquist zone for the products. When the input buffer current in Register 0x018 is set, the amount of current required by the AVDD3 supply changes. This relationship is shown in Figure 66. For a complete list of buffer current settings, see Table 36.

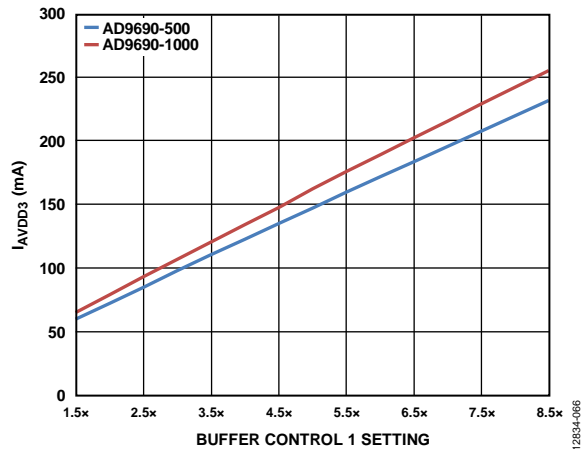

Figure 66. I_{AVDD3} vs. Buffer Control 1 Setting in Register 0x018

The 0x019, 0x01A, 0x11A, and 0x935 registers offer secondary bias controls for the input buffer for frequencies >500 MHz. Register 0x934 can be used to reduce input capacitance to achieve wider signal bandwidth but may result in slightly lower linearity and noise performance. These register settings do not impact the AVDD3 power as much as Register 0x018 does. For frequencies <500 MHz, it is recommended to use the default settings for these registers.

Table 10 shows the recommended values for the buffer current control registers for various speed grades.

Register 0x11A is used when sampling in higher Nyquist zones (>500 MHz for the AD9690-1000). This setting enables the ADC sampling network to optimize the sampling and settling times internal to the ADC for high frequency operation. For frequencies greater than 500 MHz, it is recommended to operate the ADC core at a 1.46 V full-scale setting irrespective of the speed grade. This setting offers better SFDR without any significant penalty in SNR.

Figure 67, Figure 68, and Figure 69 show the SFDR vs. analog input frequency for various buffer settings for the AD9690-1000. The recommended settings shown in Table 10 were used to take the data while changing the contents of Register 0x018 only.

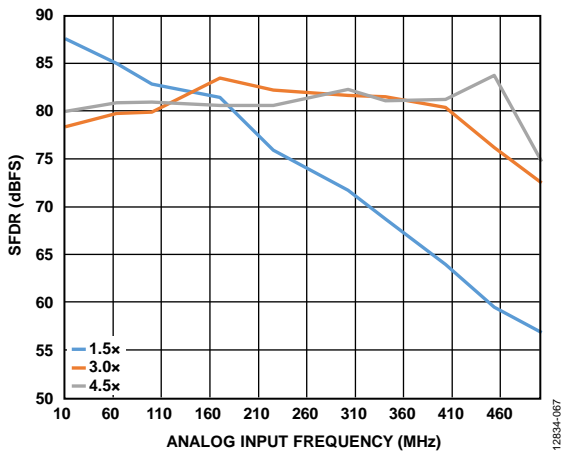

Figure 67. Buffer Current Sweeps, AD9690-1000 (SFDR vs. I_{BUFF}); $f_{IN} < 500$ MHz; Front-End Network Shown in Figure 64

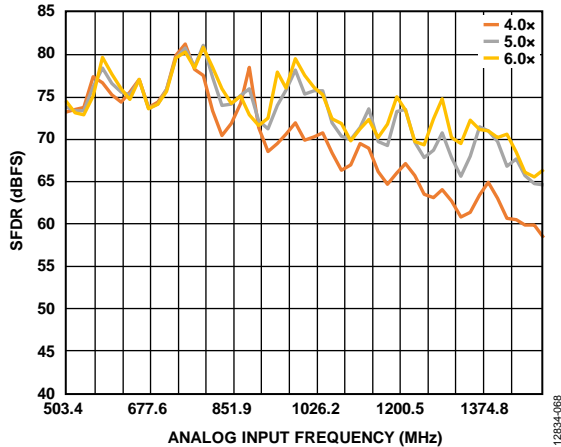

Figure 68. Buffer Current Sweeps, AD9690-1000 (SFDR vs. I_{BUFF}); 500 MHz $< f_{IN} < 1500$ MHz; Front-End Network Shown in Figure 64

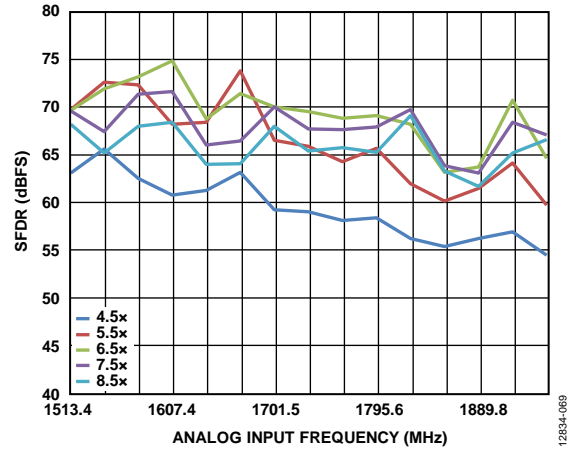

Figure 69. Buffer Current Sweeps, AD9690-1000 (SFDR vs. I_{BUFF}); 1500 MHz $< f_{IN} < 2000$ MHz; Front-End Network Shown in Figure 64

In certain high frequency applications, the SFDR can be improved by reducing the full-scale setting, as shown in Table 10.

At high frequencies, the performance of the ADC core is limited by jitter. The SFDR can be improved by backing off of the full scale level. Figure 70 shows the SFDR and SNR vs. full-scale input level at different high frequencies for the AD9690-1000.

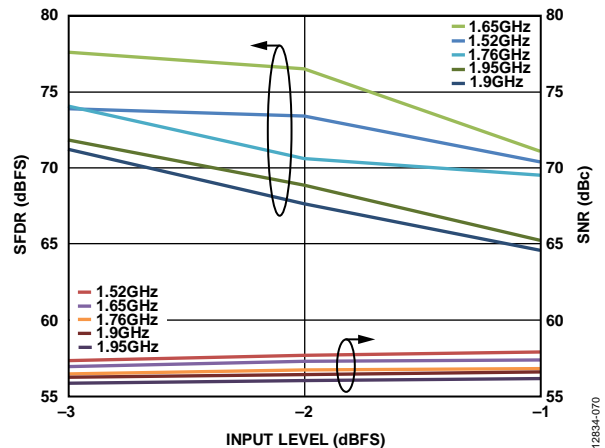

Figure 70. SNR/SFDR vs. Analog Input Level vs. Input Frequencies, AD9690-1000

Figure 71, Figure 72, and Figure 73 show the SFDR vs. analog input frequency for various buffer settings for the AD9690-500. The recommended settings shown in Table 10 were used to take the data while changing the contents of Register 0x018 only.

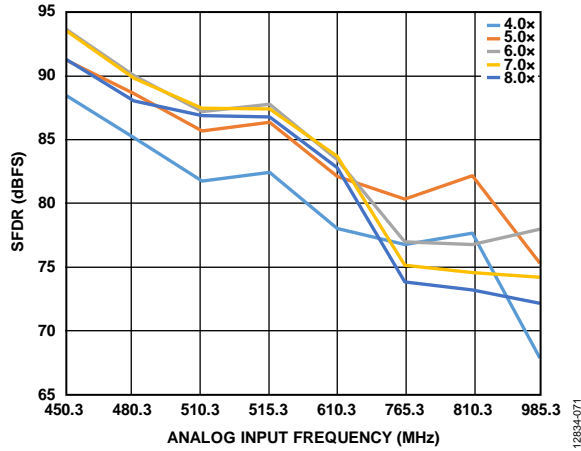

Figure 71. Buffer Current Sweeps, AD9690-500 (SFDR vs. I_{BUFF}); $450\text{ MHz} < f_{IN} < 1000\text{ MHz}$; Front-End Network Shown in Figure 64

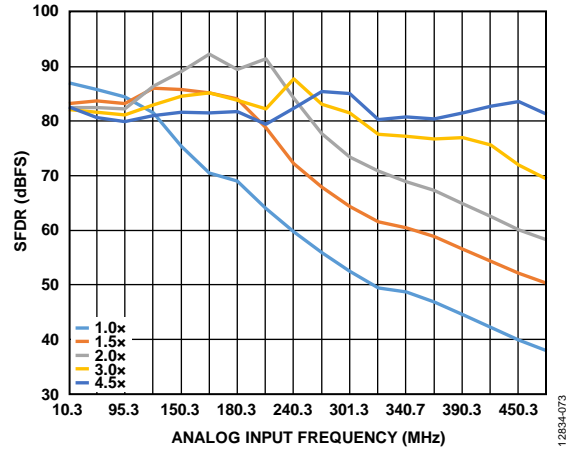

Figure 73. SFDR vs. f_{IN} ; Buffer Control 1 (0x018) = 1.0x, 1.5x, 2.0x, 3.0x, or 4.5x

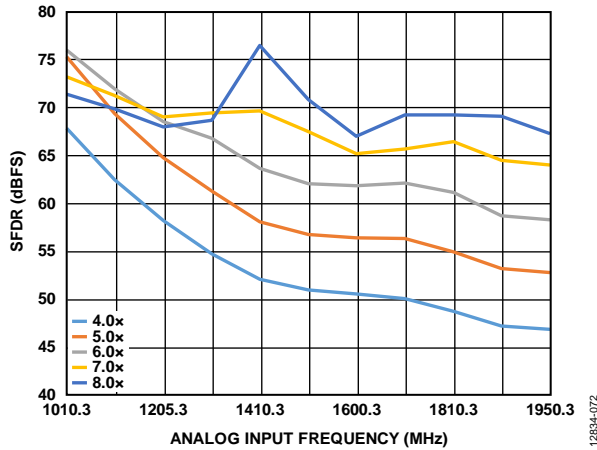

Figure 72. Buffer Current Sweeps, AD9690-500 (SFDR vs. I_{BUFF}); $1\text{ GHz} < f_{IN} < 2\text{ GHz}$; Front-End Network Shown in Figure 64

Table 10. Recommended Register Settings for SFDR Optimization at Different Input Frequencies

Product	Frequency	Buffer Control 1 (0x018)	Buffer Control 2 (0x019)	Buffer Control 3 (0x01A)	Buffer Control 4 (0x11A)	Buffer Control 5 (0x935)	Input Full-Scale Range (0x025)	Input Full-Scale Control (0x030)	Input Termination (0x016) ¹	Input Capacitance (0x934)
AD9690-500	DC to 250 MHz	0x20	0x60	0x0A	0x00	0x04	0x0C	0x04	0x0C/0x1C/...	0x1F
	250 MHz to 500 MHz	0x70	0x60	0x0A	0x00	0x04	0x0C	0x04	0x0C/0x1C/...	0x1F
	500 MHz to 1 GHz	0x80	0x40	0x08	0x00	0x00	0x08	0x18	0x0C/0x1C/...	0x1F or 0x00 ²
	1 GHz to 2 GHz	0xF0	0x40	0x08	0x00	0x00	0x08	0x18	0x0C/0x1C/...	0x1F or 0x00 ¹
AD9690-1000	DC to 150 MHz	0x10	0x50	0x09	0x00	0x04	0x0A	0x18	0x0E/0x1E/...	0x1F
	DC to 500 MHz	0x40	0x50	0x09	0x00	0x04	0x0A	0x18	0x0E/0x1E/...	0x1F
	500 MHz to 1 GHz	0xA0	0x60	0x09	0x20	0x00	0x08	0x18	0x0E/0x1E/...	0x1F or 0x00 ¹
	1 GHz to 2 GHz	0xD0	0x70	0x09	0x20	0x00	0x08	0x18	0x0E/0x1E/...	0x1F or 0x00 ¹

¹ The input termination can be changed to accommodate the application with little or no impact to ac performance.

² The input capacitance can be set to 1.5 pF to achieve wider input bandwidth but results in slightly lower ac performance.

Absolute Maximum Input Swing

The absolute maximum input swing allowed at the inputs of the AD9690 is 4.3 V p-p differential. Signals operating near or at this level can cause permanent damage to the ADC.

VOLTAGE REFERENCE

A stable and accurate 1.0 V voltage reference is built into the AD9690. This internal 1.0 V reference is used to set the full-scale input range of the ADC. The full-scale input range can be adjusted via the ADC Function Register 0x025. For more information on adjusting the input swing, see Table 36. Figure 74 shows the block diagram of the internal 1.0 V reference controls.

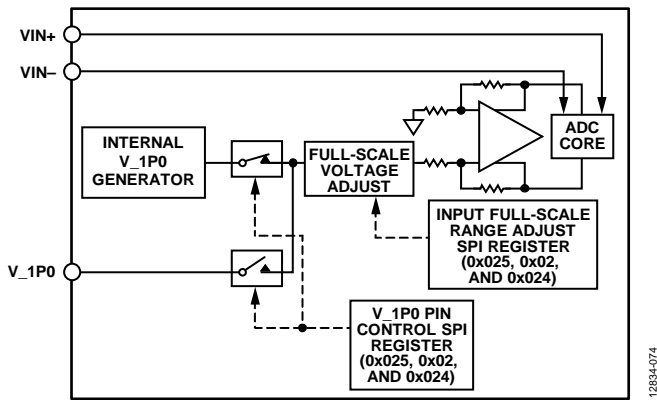

Figure 74. Internal Reference Configuration and Controls

The SPI Register 0x024 enables the user to either use this internal 1.0 V reference, or to provide an external 1.0 V reference. When using an external voltage reference, provide a 1.0 V reference. The full-scale adjustment is made using the SPI, irrespective of the reference voltage.

For more information on adjusting the full-scale level of the AD9690, refer to the Memory Map Register Table section.

The use of an external reference may be necessary, in some applications, to enhance the gain accuracy of the ADC or improve thermal drift characteristics. Figure 75 shows the typical drift characteristics of the internal 1.0 V reference.

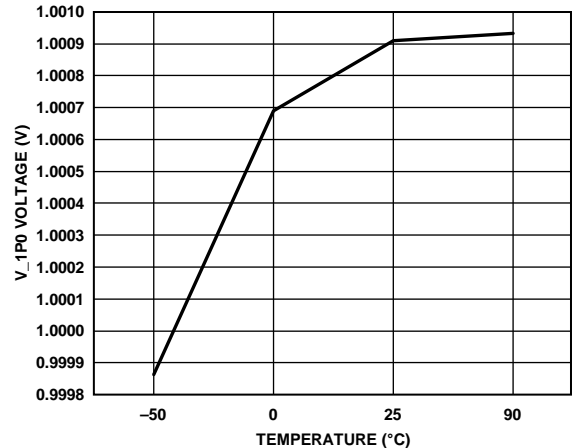

Figure 75. Typical V_1P0 Drift

The external reference has to be a stable 1.0 V reference. The ADR130 is a good option for providing the 1.0 V reference. Figure 76 shows how the ADR130 can be used to provide the external 1.0 V reference to the AD9690. The grayed out areas show unused blocks within the AD9690 while using the ADR130 to provide the external reference.

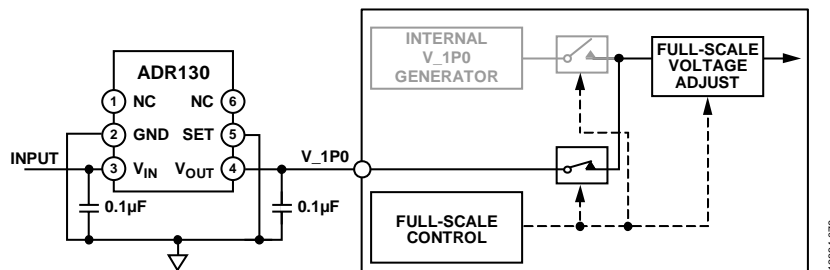

Figure 76. External Reference Using ADR130

CLOCK INPUT CONSIDERATIONS

For optimum performance, drive the AD9690 sample clock inputs (CLK+ and CLK-) with a differential signal. This signal is typically ac-coupled to the CLK+ and CLK- pins via a transformer or clock drivers. These pins are biased internally and require no additional biasing.

Figure 77 shows a preferred method for clocking the AD9690. The low jitter clock source is converted from a single-ended signal to a differential signal using an RF transformer.

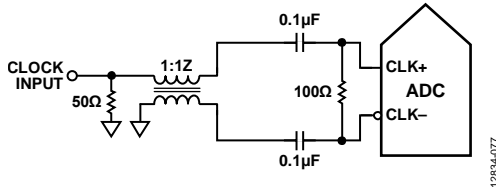

Figure 77. Transformer-Coupled Differential Clock

Another option is to ac couple a differential CML or LVDS signal to the sample clock input pins, as shown in Figure 78 and Figure 79.

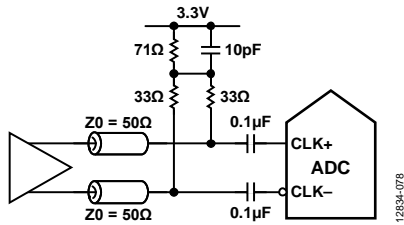
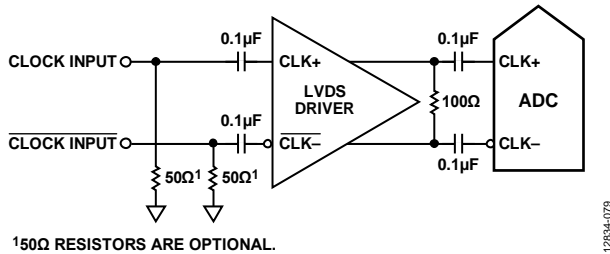

Figure 78. Differential CML Sample Clock



150Ω RESISTORS ARE OPTIONAL.

Figure 79. Differential LVDS Sample Clock

Clock Duty Cycle Considerations

Typical high speed ADCs use both clock edges to generate a variety of internal timing signals. As a result, these ADCs may be sensitive to clock duty cycle. Commonly, a 5% tolerance is required on the clock duty cycle to maintain dynamic performance characteristics. In applications where the clock duty cycle cannot be guaranteed to be 50%, a higher multiple frequency clock can be supplied to the device. The AD9690 can be clocked at 2 GHz with the internal clock divider set to 2. The output of the divider offers a 50% duty cycle, high slew rate (fast edge) clock signal to the internal ADC. See the Memory Map section for more details on using this feature.

Input Clock Divider

The AD9690 contains an input clock divider with the ability to divide the Nyquist input clock by 1, 2, 4, and 8. The divider ratios can be selected using Register 0x10B. This is shown in Figure 80.

The maximum frequency at the CLK± inputs is 4 GHz. This is the limit of the divider. In applications where the clock input is a multiple of the sample clock, care must be taken to program the appropriate divider ratio into the clock divider before applying the clock signal. This ensures that the current transients during device startup are controlled.

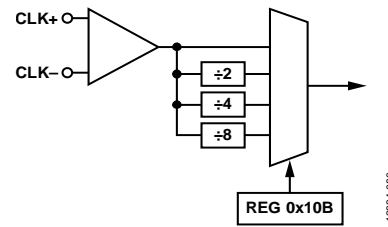

Figure 80. Clock Divider Circuit

The AD9690 clock divider can be synchronized using the external SYSREF± input. A valid SYSREF± causes the clock divider to reset to a programmable state. This synchronization feature allows multiple devices to have their clock dividers aligned to guarantee simultaneous input sampling.

Input Clock Divider 1/2 Period Delay Adjust

The input clock divider inside the AD9690 provides phase delay in increments of 1/2 the input clock cycle. Register 0x10C can be programmed to enable this delay independently for each channel. Changing this register does not affect the stability of the JESD204B link.

Clock Fine Delay Adjust

The AD9690 sampling edge instant can be adjusted by writing to Register 0x117 and Register 0x118. Setting Bit 0 of Register 0x117 enables the feature, and Bits[7:0] of Register 0x118 set the value of the delay. This value can be programmed individually for each channel. The clock delay can be adjusted from -151.7 ps to +150 ps in ~1.7 ps increments. The clock delay adjust takes effect immediately when it is enabled via SPI writes. Enabling the clock fine delay adjust in Register 0x117 causes a datapath reset. However, the contents of Register 0x118 can be changed without affecting the stability of the JESD204B link.

Clock Jitter Considerations

High speed, high resolution ADCs are sensitive to the quality of the clock input. The degradation in SNR at a given input frequency (f_A) due only to aperture jitter (t_j) can be calculated by

$$SNR = 20 \times \log_{10} (2 \times \pi \times f_A \times t_j)$$

In this equation, the rms aperture jitter represents the root mean square of all jitter sources, including the clock input, analog input signal, and ADC aperture jitter specifications. IF undersampling applications are particularly sensitive to jitter (see Figure 81).

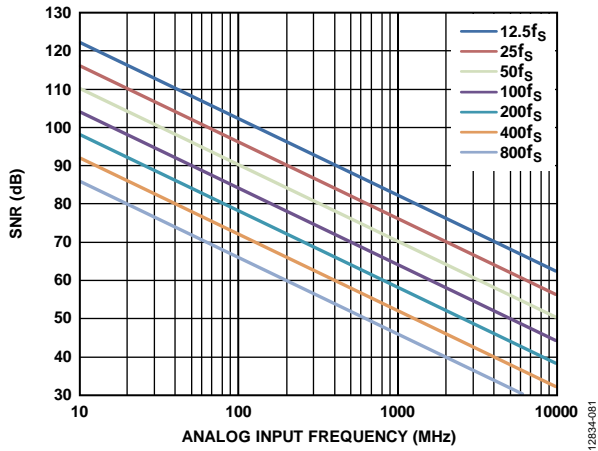

Figure 81. Ideal SNR vs. Analog Input Frequency and Jitter

Treat the clock input as an analog signal in cases where aperture jitter may affect the dynamic range of the AD9690. Separate power supplies for clock drivers from the ADC output driver supplies to avoid modulating the clock signal with digital noise. If the clock is generated from another type of source (by gating, dividing, or other methods), retime the clock by the original clock at the last step. Refer to the AN-501 Application Note and the AN-756 Application Note for more in-depth information about jitter performance as it relates to ADCs.

Power-Down/Standby Mode

The AD9690 has a PDWN/STBY pin which can be used to configure the device in power-down or standby mode. The default operation is PDWN. The PDWN/STBY pin is a logic high pin. When in power-down mode, the JESD204B link is disrupted. The power-down option can also be set via Register 0x03F and Register 0x040.

In standby mode, the JESD204B link is not disrupted and transmits zeroes for all converter samples. This can be changed using Register 0x571, Bit 7 to select /K/ characters.

Temperature Diode

The AD9690 contains a diode-based temperature sensor for measuring the temperature of the die. This diode can output a voltage and serve as a coarse temperature sensor to monitor the internal die temperature.

The temperature diode voltage can be output to the FD pin using the SPI. Use Register 0x028, Bit 0 to enable or disable the diode. Configure the FD pin to output the diode voltage by programming Register 0x040[2:0]. See Table 36 for more information.

The voltage response of the temperature diode (SPIVDD = 1.8 V) is shown in Figure 82.



Figure 82. Temperature Diode Voltage vs. Temperature

ADC OVERRANGE AND FAST DETECT

In receiver applications, it is desirable to have a mechanism to reliably determine when the converter is about to be clipped. The standard overrange bit in the JESD204B outputs provides information on the state of the analog input that is of limited usefulness. Therefore, it is helpful to have a programmable threshold below full scale that allows time to reduce the gain before the clip actually occurs. In addition, because input signals can have significant slew rates, the latency of this function is of major concern. Highly pipelined converters can have significant latency. The AD9690 contains fast detect circuitry to monitor the threshold and assert the FD pin.

ADC OVERRANGE

The ADC overrange indicator is asserted when an overrange is detected on the input of the ADC. The overrange indicator can be embedded within the JESD204B link as a control bit (when CSB > 0). The latency of this overrange indicator matches the sample latency.

The AD9690 also records any overrange condition in any of the eight virtual converters. For more information on the virtual converters, refer to Figure 88. The overrange status of each virtual converter is registered as a sticky bit in Register 0x563. The contents of Register 0x563 can be cleared using Register 0x562, by toggling the bits corresponding to the virtual converter to set and reset position.

FAST THRESHOLD DETECTION (FD)

The FD bit is immediately set whenever the absolute value of the input signal exceeds the programmable upper threshold level. The FD bit is only cleared when the absolute value of the input signal drops below the lower threshold level for greater than the programmable dwell time. This feature provides hysteresis and prevents the FD bit from excessively toggling.

The operation of the upper threshold and lower threshold registers, along with the dwell time registers, is shown in Figure 83.

The FD indicator is asserted if the input magnitude exceeds the value programmed in the fast detect upper threshold registers, located at Register 0x247 and Register 0x248. The selected threshold register is compared with the signal magnitude at the output of the ADC. The fast upper threshold detection has a latency of 28 clock cycles (maximum). The approximate upper threshold magnitude is defined by

$$\text{Upper Threshold Magnitude (dBFS)} = 20 \log (\text{Threshold Magnitude}/2^{13})$$

The FD indicators are not cleared until the signal drops below the lower threshold for the programmed dwell time. The lower threshold is programmed in the fast detect lower threshold registers, located at Register 0x249 and Register 0x24A. The fast detect lower threshold register is a 13-bit register that is compared with the signal magnitude at the output of the ADC. This comparison is subject to the ADC pipeline latency, but is accurate in terms of converter resolution. The lower threshold magnitude is defined by

$$\text{Lower Threshold Magnitude (dBFS)} = 20 \log (\text{Threshold Magnitude}/2^{13})$$

For example, to set an upper threshold of -6 dBFS, write 0xFF to Register 0x247 and Register 0x248. To set a lower threshold of -10 dBFS, write 0xA1D to Register 0x249 and Register 0x24A.

The dwell time can be programmed from 1 to 65,535 sample clock cycles by placing the desired value in the fast detect dwell time registers, located at Register 0x24B and Register 0x24C. See the Memory Map section (Register 0x040, and Register 0x245 to Register 0x24C in Table 36) for more details.

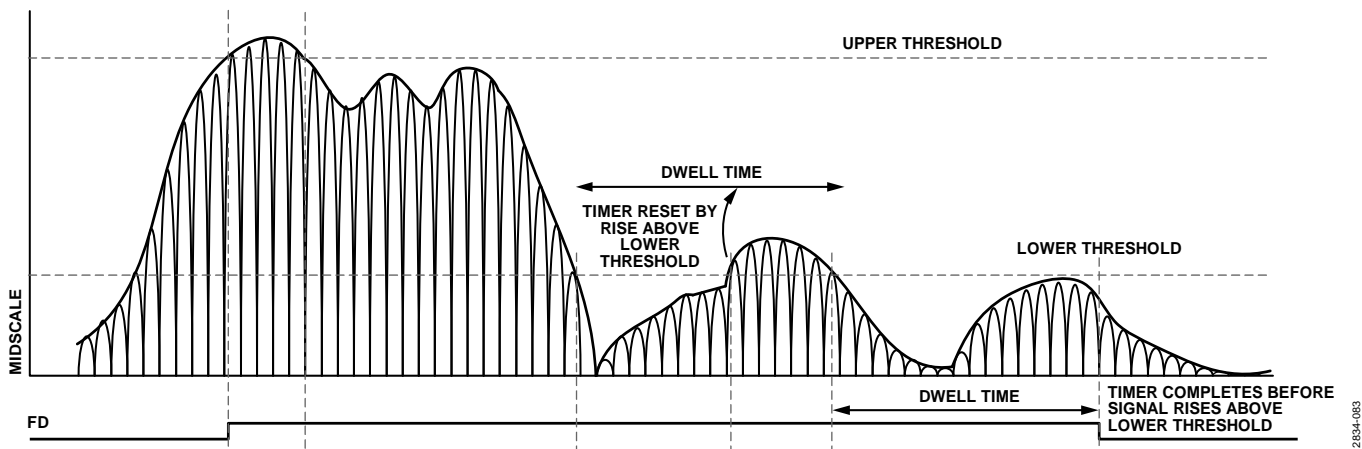

Figure 83. Threshold Settings for FD Signals

12894-083

SIGNAL MONITOR

The signal monitor block provides additional information about the signal being digitized by the ADC. The signal monitor computes the peak magnitude of the digitized signal. This information can be used to drive an AGC loop to optimize the range of the ADC in the presence of real-world signals.

The results of the signal monitor block can be obtained either by reading back the internal values from the SPI port or by embedding the signal monitoring information into the JESD204B interface as special control bits. A 24-bit programmable period controls the duration of the measurement. Figure 84 shows the simplified block diagram of the signal monitor block.

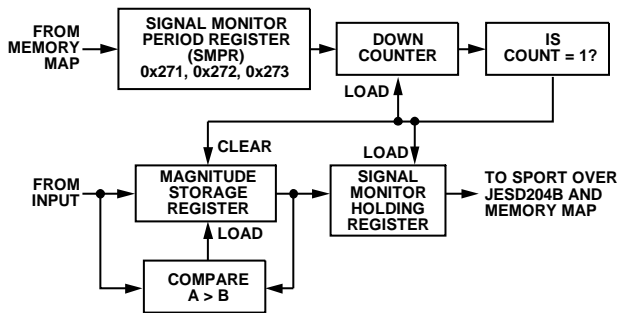

Figure 84. Signal Monitor Block

The peak detector captures the largest signal within the observation period. The detector only observes the magnitude of the signal. The resolution of the peak detector is a 13-bit value, and the observation period is 24 bits and represents converter output samples. The peak magnitude can be derived by using the following equation:

$$\text{Peak Magnitude (dBFS)} = 20\log(\text{Peak Detector Value}/2^{13})$$

The magnitude of the input port signal is monitored over a programmable time period, which is determined by the signal monitor period register (SMPR). The peak detector function is enabled by setting Bit 1 of Register 0x270 in the signal monitor control register. The 24-bit SMPR must be programmed before activating this mode.

After enabling peak detection mode, the value in the SMPR is loaded into a monitor period timer, which decrements at the decimated clock rate.

The magnitude of the input signal is compared with the value in the internal magnitude storage register (not accessible to the user), and the greater of the two is updated as the current peak level. The initial value of the magnitude storage register is set to the current ADC input signal magnitude. This comparison continues until the monitor period timer reaches a count of 1.

When the monitor period timer reaches a count of 1, the 13-bit peak level value is transferred to the signal monitor holding register, which can be read through the memory map or output through the SPORT over the JESD204B interface. The monitor period timer is reloaded with the value in the SMPR, and the countdown is restarted. In addition, the magnitude of the first input sample is updated in the magnitude storage register, and the comparison and update procedure, as explained previously, continues.

SPORT OVER JESD204B

The signal monitor data can also be serialized and sent over the JESD204B interface as control bits. These control bits must be deserialized from the samples to reconstruct the statistical data. The signal control monitor function is enabled by setting Bits[1:0] of Register 0x279 and Bit 1 of Register 0x27A. Figure 85 shows two different example configurations for the signal monitor control bit locations inside the JESD204B samples. A maximum of three control bits can be inserted into the JESD204B samples; however, only one control bit is required for the signal monitor. Control bits are inserted from MSB to LSB. If only one control bit is to be inserted (CS = 1), only the most significant control bit is used (see Example Configuration 1 and Example Configuration 2 in Figure 85). To select the SPORT over JESD204B option, program Register 0x559, Register 0x55A, and Register 0x58F. See Table 36 for more information on setting these bits.

Figure 86 shows the 25-bit frame data that encapsulates the peak detector value. The frame data is transmitted MSB first with five 5-bit subframes. Each subframe contains a start bit that can be used by a receiver to validate the deserialized data. Figure 87 shows the SPORT over JESD204B signal monitor data with a monitor period timer set to 80 samples.

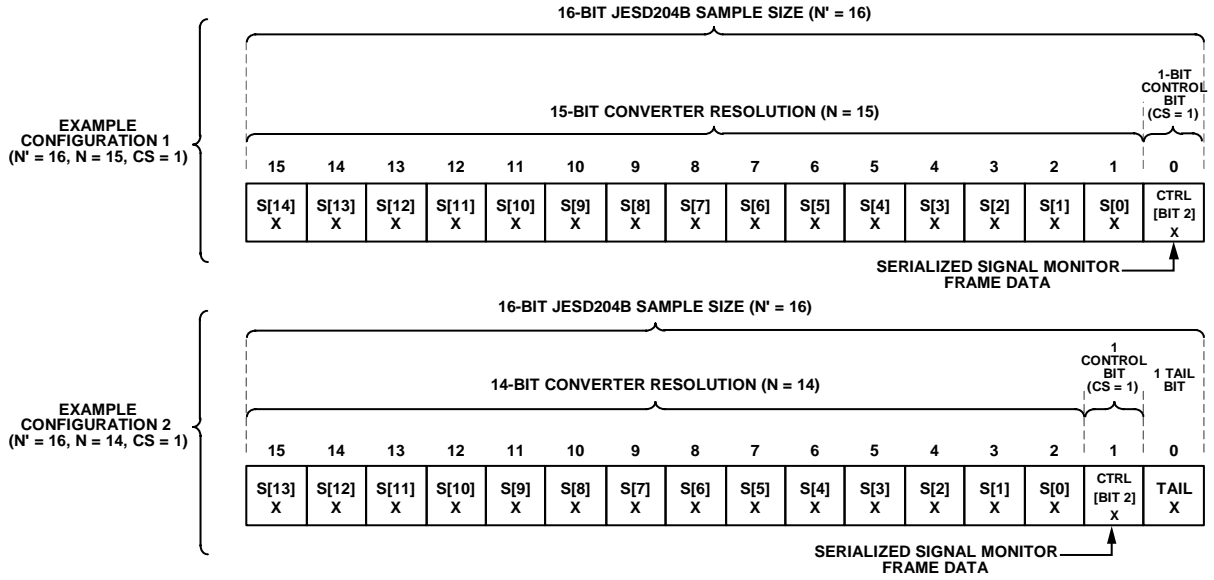

Figure 85. Signal Monitor Control Bit Locations

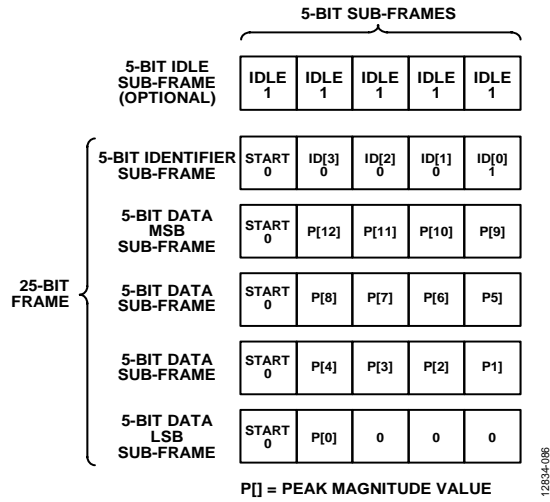

Figure 86. SPORT over JESD204B Signal Monitor Frame Data

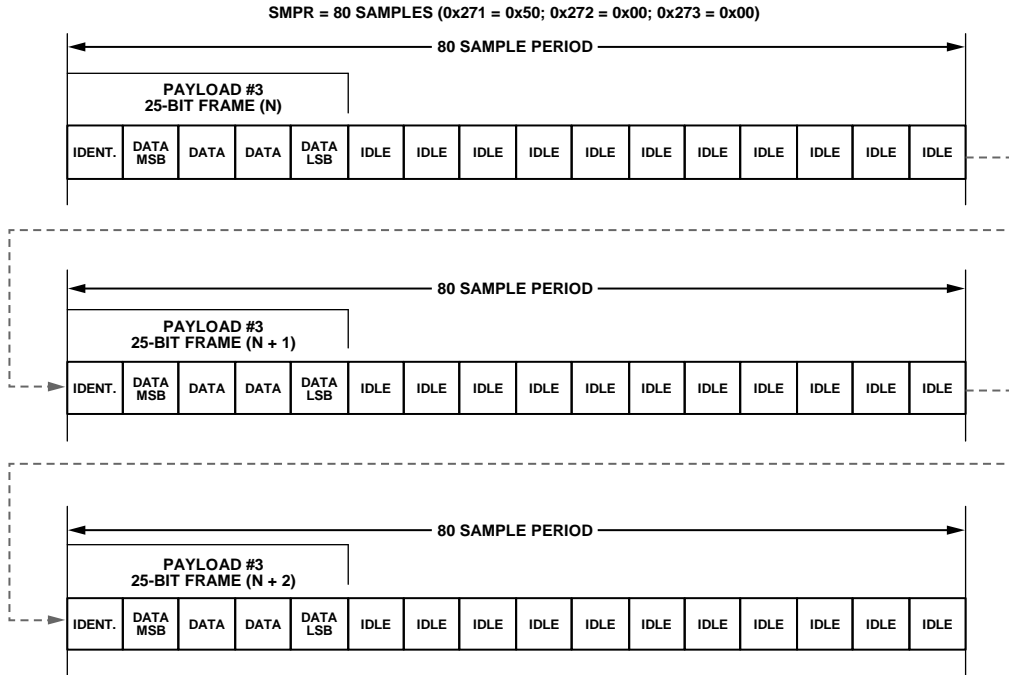

Figure 87. SPORT over JESD204B Signal Monitor Example with Period = 80 Samples

12834-087

DIGITAL DOWNCONVERTER (DDC)

The [AD9690](#) includes two digital downconverters (DDC 0 and DDC 1) that provide filtering and reduce the output data rate. This digital processing section includes an NCO, a half-band decimating filter, an FIR filter, a gain stage, and a complex-real conversion stage. Each of these processing blocks has control lines that allow it to be independently enabled and disabled to provide the desired processing function. The digital downconverter can be configured to output either real data or complex output data.

DDC I/Q INPUT SELECTION

The [AD9690](#) has one ADC channel and two DDC channels. Each DDC channel has two input ports that can be paired to support real inputs through the I/Q crossbar mux.

The inputs to each DDC are controlled by the DDC input selection registers (Register 0x311, and Register 0x331). See Table 36 for information on how to configure the DDCs.

DDC I/Q OUTPUT SELECTION

Each DDC channel has two output ports that can be paired to support both real or complex outputs. For real output signals, only the DDC Output Port I is used (the DDC Output Port Q is invalid). For complex I/Q output signals, both DDC Output Port I and DDC Output Port Q are used.

The I/Q outputs to each DDC channel are controlled by the DDC complex to real enable bit (Bit 3) in the DDC control registers (Register 0x310, and Register 0x330).

The Chip Q ignore bit (Bit 5) in the chip application mode register (Register 0x200) controls the chip output muxing of all the DDC channels. When all DDC channels use real outputs, this bit must be set high to ignore all DDC Q output ports. When any of the DDC channels are set to use complex I/Q outputs, the user must clear this bit to use both DDC Output Port I and DDC Output Port Q. For more information, refer to Figure 96.

DDC GENERAL DESCRIPTION

The two DDC blocks are used to extract a portion of the full digital spectrum captured by the ADC(s). They are intended for IF sampling or oversampled baseband radios requiring wide bandwidth input signals.

Each DDC block contains the following signal processing stages:

Frequency Translation Stage (Optional)

The frequency translation stage consists of a 12-bit complex NCO and quadrature mixers that can be used for frequency translation of both real or complex input signals. This stage shifts a portion of the available digital spectrum down to baseband.

Filtering Stage

After shifting down to baseband, the filtering stage decimates the frequency spectrum using a chain of up to four half-band low-pass filters for rate conversion. The decimation process lowers the output data rate, which in turn reduces the output interface rate.

Gain Stage (Optional)

Due to losses associated with mixing a real input signal down to baseband, the gain stage compensates by adding an additional 0 dB or 6 dB of gain.

Complex to Real Conversion Stage (Optional)

When real outputs are necessary, the complex to real conversion stage converts the complex outputs back to real by performing an $f_s/4$ mixing operation plus a filter to remove the complex component of the signal.

Figure 88 shows the detailed block diagram of the DDCs implemented in the [AD9690](#).

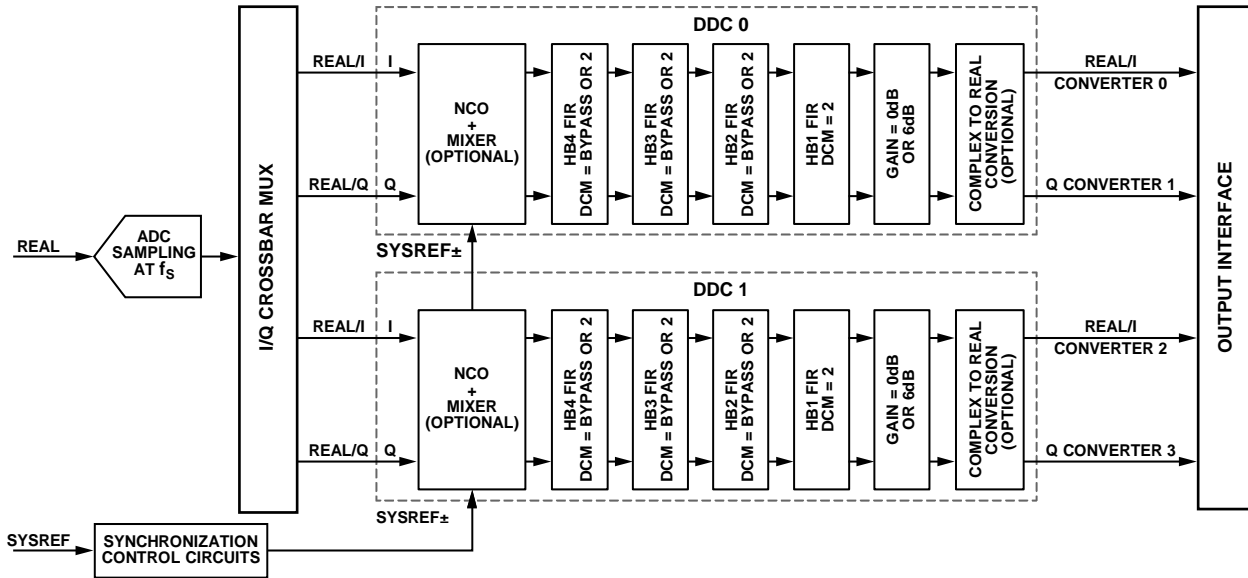

Figure 88. DDC Detailed Block Diagram

Figure 89 shows an example usage of one of the two DDC blocks with a real input signal and four half-band filters (HB4, HB3, HB2, and HB1). It shows both complex (decimate by 16) and real (decimate by 8) output options.

When DDCs have different decimation ratios, the chip decimation ratio (Register 0x201) must be set to the lowest decimation ratio of all the DDC blocks.

In this scenario, samples of higher decimation ratio DDCs are repeated to match the chip decimation ratio sample rate. Whenever the NCO frequency is set or changed, the DDC output reset must be issued. If the DDC soft reset is not issued, the output may potentially show amplitude variations.

Table 11, Table 12, Table 13, Table 14, and Table 15 show the DDC samples when the chip decimation ratio is set to 1, 2, 4, 8, or 16, respectively.

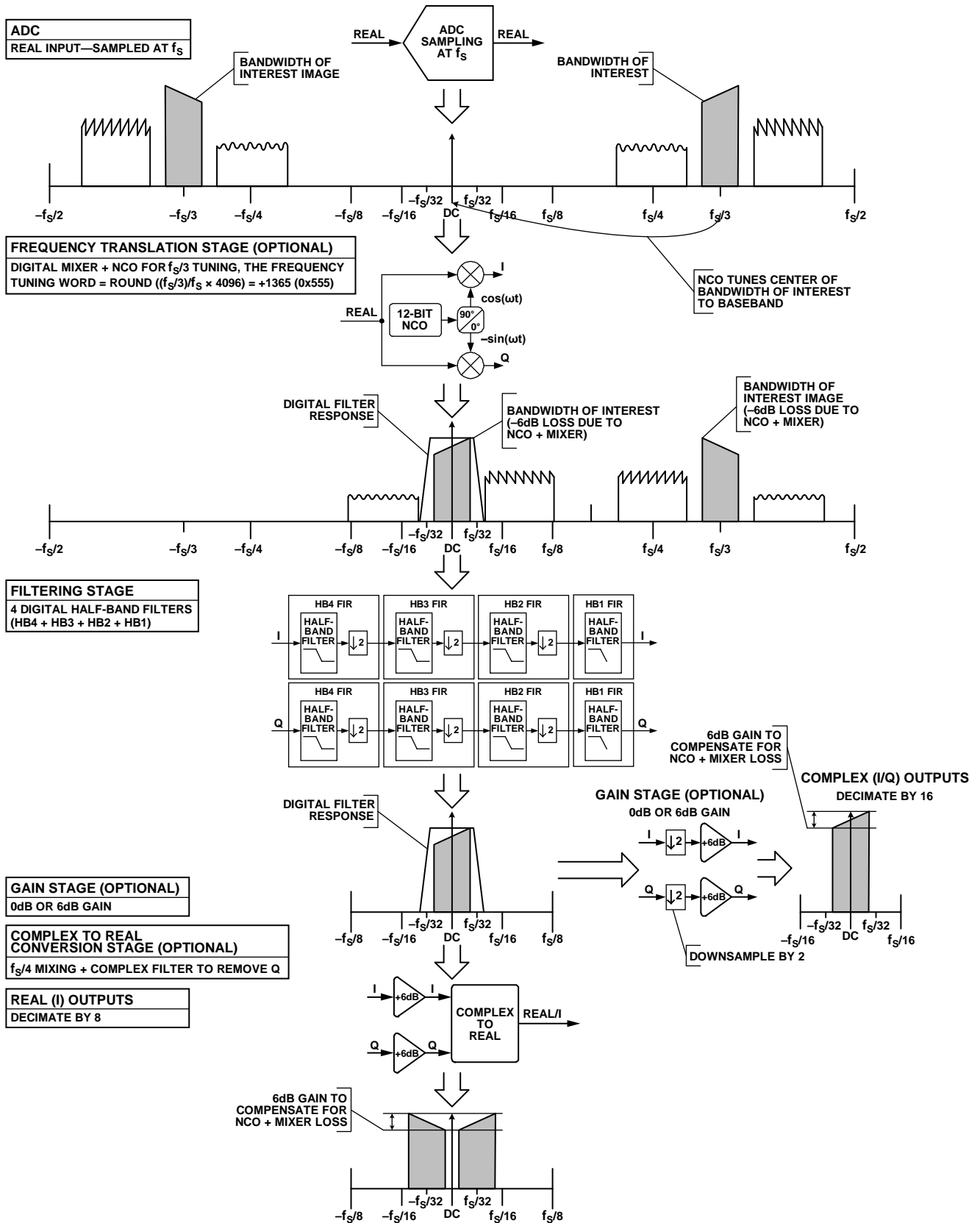

Figure 89. DDC Theory of Operation Example (Real Input—Decimate by 16)

Table 11. DDC Samples, Chip Decimation Ratio = 1

Real (I) Output (Complex to Real Enabled)				Complex (I/Q) Outputs (Complex to Real Disabled)			
HB1 FIR (DCM ¹ = 1)	HB2 FIR + HB1 FIR (DCM ¹ = 2)	HB3 FIR + HB2 FIR + HB1 FIR (DCM ¹ = 4)	HB4 FIR + HB3 FIR + HB2 FIR + HB1 FIR (DCM ¹ = 8)	HB1 FIR (DCM ¹ = 2)	HB2 FIR + HB1 FIR (DCM ¹ = 4)	HB3 FIR + HB2 FIR + HB1 FIR (DCM ¹ = 8)	HB4 FIR + HB3 FIR + HB2 FIR + HB1 FIR (DCM ¹ = 16)
N	N	N	N	N	N	N	N
N + 1	N + 1	N + 1	N + 1	N + 1	N + 1	N + 1	N + 1
N + 2	N	N	N	N	N	N	N
N + 3	N + 1	N + 1	N + 1	N + 1	N + 1	N + 1	N + 1
N + 4	N + 2	N	N	N + 2	N	N	N
N + 5	N + 3	N + 1	N + 1	N + 3	N + 1	N + 1	N + 1
N + 6	N + 2	N	N	N + 2	N	N	N
N + 7	N + 3	N + 1	N + 1	N + 3	N + 1	N + 1	N + 1
N + 8	N + 4	N + 2	N	N + 4	N + 2	N	N
N + 9	N + 5	N + 3	N + 1	N + 5	N + 3	N + 1	N + 1
N + 10	N + 4	N + 2	N	N + 4	N + 2	N	N
N + 11	N + 5	N + 3	N + 1	N + 5	N + 3	N + 1	N + 1
N + 12	N + 6	N + 2	N	N + 6	N + 2	N	N
N + 13	N + 7	N + 3	N + 1	N + 7	N + 3	N + 1	N + 1
N + 14	N + 6	N + 2	N	N + 6	N + 2	N	N
N + 15	N + 7	N + 3	N + 1	N + 7	N + 3	N + 1	N + 1
N + 16	N + 8	N + 4	N + 2	N + 8	N + 4	N + 2	N
N + 17	N + 9	N + 5	N + 3	N + 9	N + 5	N + 3	N + 1
N + 18	N + 8	N + 4	N + 2	N + 8	N + 4	N + 2	N
N + 19	N + 9	N + 5	N + 3	N + 9	N + 5	N + 3	N + 1
N + 20	N + 10	N + 4	N + 2	N + 10	N + 4	N + 2	N
N + 21	N + 11	N + 5	N + 3	N + 11	N + 5	N + 3	N + 1
N + 22	N + 10	N + 4	N + 2	N + 10	N + 4	N + 2	N
N + 23	N + 11	N + 5	N + 3	N + 11	N + 5	N + 3	N + 1
N + 24	N + 12	N + 6	N + 2	N + 12	N + 6	N + 2	N
N + 25	N + 13	N + 7	N + 3	N + 13	N + 7	N + 3	N + 1
N + 26	N + 12	N + 6	N + 2	N + 12	N + 6	N + 2	N
N + 27	N + 13	N + 7	N + 3	N + 13	N + 7	N + 3	N + 1
N + 28	N + 14	N + 6	N + 2	N + 14	N + 6	N + 2	N
N + 29	N + 15	N + 7	N + 3	N + 15	N + 7	N + 3	N + 1
N + 30	N + 14	N + 6	N + 2	N + 14	N + 6	N + 2	N
N + 31	N + 15	N + 7	N + 3	N + 15	N + 7	N + 3	N + 1

¹ DCM = decimation.

Table 12. DDC Samples, Chip Decimation Ratio = 2

Real (I) Output (Complex to Real Enabled)			Complex (I/Q) Outputs (Complex to Real Disabled)			
HB2 FIR + HB1 FIR (DCM ¹ = 2)	HB3 FIR + HB2 FIR + HB1 FIR (DCM ¹ = 4)	HB4 FIR + HB3 FIR + HB2 FIR + HB1 FIR (DCM ¹ = 8)	HB1 FIR (DCM ¹ = 2)	HB2 FIR + HB1 FIR (DCM ¹ = 4)	HB3 FIR + HB2 FIR + HB1 FIR (DCM ¹ = 8)	HB4 FIR + HB3 FIR + HB2 FIR + HB1 FIR (DCM ¹ = 16)
N	N	N	N	N	N	N
N + 1	N + 1	N + 1	N + 1	N + 1	N + 1	N + 1
N + 2	N	N	N + 2	N	N	N
N + 3	N + 1	N + 1	N + 3	N + 1	N + 1	N + 1
N + 4	N + 2	N	N + 4	N + 2	N	N
N + 5	N + 3	N + 1	N + 5	N + 3	N + 1	N + 1
N + 6	N + 2	N	N + 6	N + 2	N	N
N + 7	N + 3	N + 1	N + 7	N + 3	N + 1	N + 1
N + 8	N + 4	N + 2	N + 8	N + 4	N + 2	N
N + 9	N + 5	N + 3	N + 9	N + 5	N + 3	N + 1
N + 10	N + 4	N + 2	N + 10	N + 4	N + 2	N
N + 11	N + 5	N + 3	N + 11	N + 5	N + 3	N + 1
N + 12	N + 6	N + 2	N + 12	N + 6	N + 2	N
N + 13	N + 7	N + 3	N + 13	N + 7	N + 3	N + 1
N + 14	N + 6	N + 2	N + 14	N + 6	N + 2	N
N + 15	N + 7	N + 3	N + 15	N + 7	N + 3	N + 1

¹ DCM = decimation.

Table 13. DDC Samples, Chip Decimation Ratio = 4

Real (I) Output (Complex to Real Enabled)		Complex (I/Q) Outputs (Complex to Real Disabled)		
HB3 FIR + HB2 FIR + HB1 FIR (DCM ¹ = 4)	HB4 FIR + HB3 FIR + HB2 FIR + HB1 FIR (DCM ¹ = 8)	HB2 FIR + HB1 FIR (DCM ¹ = 4)	HB3 FIR + HB2 FIR + HB1 FIR (DCM ¹ = 8)	HB4 FIR + HB3 FIR + HB2 FIR + HB1 FIR (DCM ¹ = 16)
N	N	N	N	N
N + 1	N + 1	N + 1	N + 1	N + 1
N + 2	N	N + 2	N	N
N + 3	N + 1	N + 3	N + 1	N + 1
N + 4	N + 2	N + 4	N + 2	N
N + 5	N + 3	N + 5	N + 3	N + 1
N + 6	N + 2	N + 6	N + 2	N
N + 7	N + 3	N + 7	N + 3	N + 1

¹ DCM = decimation.

Table 14. DDC Samples, Chip Decimation Ratio = 8

Real (I) Output (Complex to Real Enabled)	Complex (I/Q) Outputs (Complex to Real Disabled)	
HB4 FIR + HB3 FIR + HB2 FIR + HB1 FIR (DCM ¹ = 8)	HB3 FIR + HB2 FIR + HB1 FIR (DCM ¹ = 8)	HB4 FIR + HB3 FIR + HB2 FIR + HB1 FIR (DCM ¹ = 16)
N	N	N
N + 1	N + 1	N + 1
N + 2	N + 2	N
N + 3	N + 3	N + 1
N + 4	N + 4	N + 2
N + 5	N + 5	N + 3
N + 6	N + 6	N + 2
N + 7	N + 7	N + 3

¹ DCM = decimation.

Table 15. DDC Samples, Chip Decimation Ratio = 16

Real (I) Output (Complex to Real Enabled)	Complex (I/Q) Outputs (Complex to Real Disabled)
HB4 FIR + HB3 FIR + HB2 FIR + HB1 FIR (DCM¹ = 16)	HB4 FIR + HB3 FIR + HB2 FIR + HB1 FIR (DCM¹ = 16)
Not applicable	N
Not applicable	N + 1
Not applicable	N + 2
Not applicable	N + 3

¹ DCM = decimation.

If the chip decimation ratio is set to decimate by 4, DDC 0 is set to use HB2 + HB1 filters (complex outputs decimate by 4), and DDC 1 is set to use HB4 + HB3 + HB2 + HB1 filters (real outputs decimate by 8), then DDC 1 repeats its output data two times for every one DDC 0 output. The resulting output samples are shown in Table 16.

Table 16. DDC Output Samples when Chip DCM¹ = 4, DDC 0 DCM¹ = 4 (Complex), and DDC 1 DCM¹ = 8 (Real)

DDC Input Samples	DDC 0		DDC 1	
	Output Port I	Output Port Q	Output Port I	Output Port Q
N	I0 [N]	Q0 [N]	I1 [N]	Not applicable
N + 1				
N + 2				
N + 3				
N + 4	I0 [N + 1]	Q0 [N + 1]	I1 [N + 1]	Not applicable
N + 5				
N + 6				
N + 7				
N + 8	I0 [N + 2]	Q0 [N + 2]	I1 [N]	Not applicable
N + 9				
N + 10				
N + 11				
N + 12	I0 [N + 3]	Q0 [N + 3]	I1 [N + 1]	Not applicable
N + 13				
N + 14				
N + 15				

¹ DCM = decimation.

FREQUENCY TRANSLATION

GENERAL DESCRIPTION

Frequency translation is accomplished by using a 12-bit complex NCO along with a digital quadrature mixer. The frequency translation translates either a real or complex input signal from an intermediate frequency (IF) to a baseband complex digital output (carrier frequency = 0 Hz).

The frequency translation stage of each DDC can be controlled individually and supports four different IF modes using Bits[5:4] of the DDC control registers (Register 0x310, and Register 0x330). These IF modes are

- Variable IF mode
- 0 Hz IF (ZIF) mode
- $f_s/4$ Hz IF mode
- Test mode

Variable IF Mode

NCO and mixers are enabled. NCO output frequency can be used to digitally tune the IF frequency.

0 Hz IF (ZIF) Mode

Mixers are bypassed and the NCO disabled.

$f_s/4$ Hz IF Mode

Mixers and NCO are enabled in special down mixing by $f_s/4$ mode to save power.

Test Mode

Input samples are forced to 0.999 to positive full scale. NCO is enabled. This test mode allows the NCOs to directly drive the decimation filters.

Figure 90 and Figure 91 show examples of the frequency translation stage for both real and complex inputs.

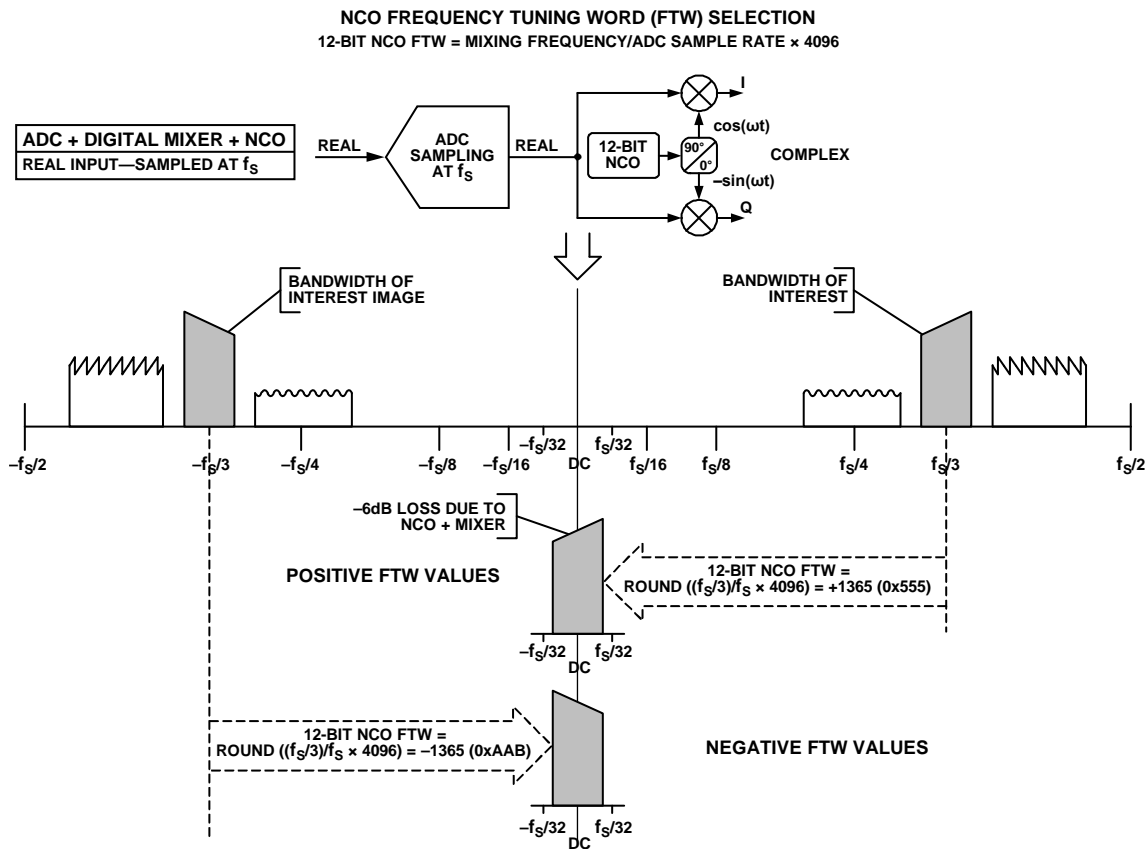

Figure 90. DDC NCO Frequency Tuning Word Selection—Real Inputs

12834-090

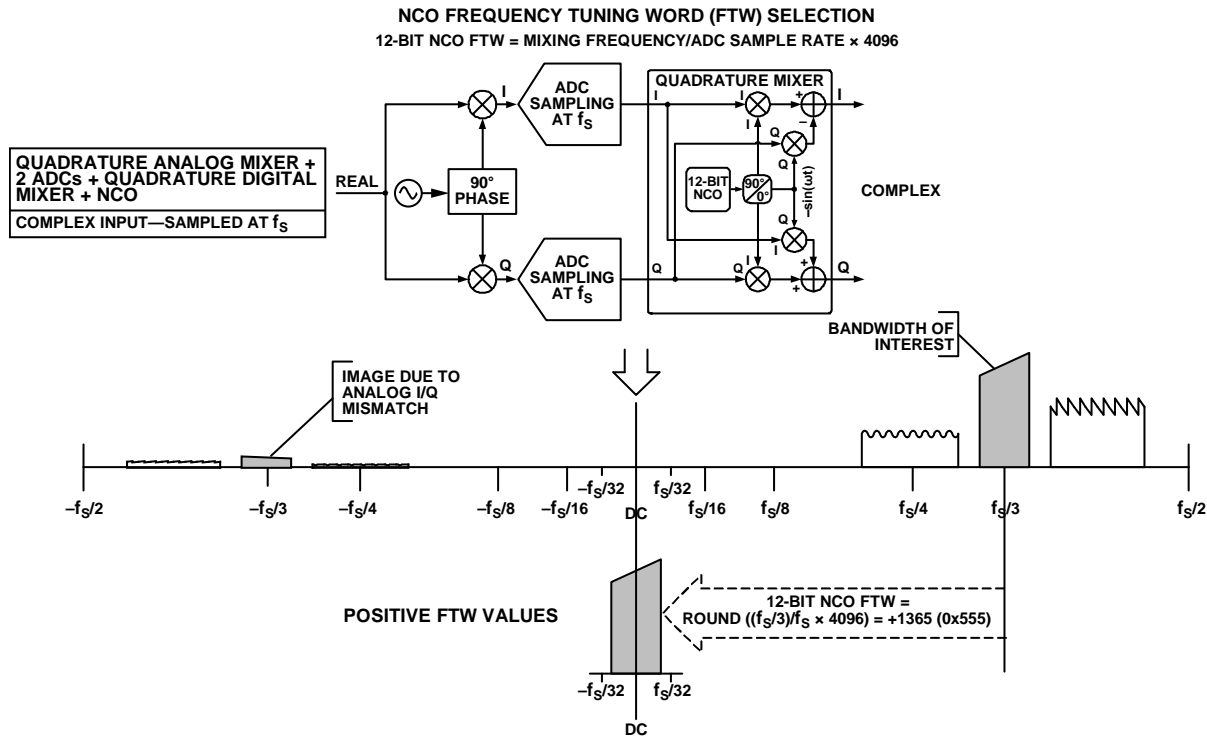

Figure 91. DDC NCO Frequency Tuning Word Selection—Complex Inputs

DDC NCO PLUS MIXER LOSS AND SFDR

When mixing a real input signal down to baseband, 6 dB of loss is introduced in the signal due to filtering of the negative image. An additional 0.05 dB of loss is introduced by the NCO. The total loss of a real input signal mixed down to baseband is 6.05 dB. For this reason, it is recommended that the user compensate for this loss by enabling the additional 6 dB of gain in the gain stage of the DDC to recenter the dynamic range of the signal within the full scale of the output bits.

When mixing a complex input signal down to baseband, the maximum value each I/Q sample can reach is $1.414 \times$ full scale after it passes through the complex mixer. To avoid overrange of the I/Q samples and to keep the data bitwidths aligned with real mixing, 3.06 dB of loss ($0.707 \times$ full scale) is introduced in the mixer for complex signals. An additional 0.05 dB of loss is introduced by the NCO. The total loss of a complex input signal mixed down to baseband is -3.11 dB.

The worst case spurious signal from the NCO is greater than 102 dBc SFDR for all output frequencies.

NUMERICALLY CONTROLLED OSCILLATOR

The AD9690 has a 12-bit NCO for each DDC that enables the frequency translation process. The NCO allows the input spectrum to be tuned to dc, where it can be effectively filtered by the subsequent filter blocks to prevent aliasing. The NCO can be set up by providing a frequency tuning word (FTW) and a phase offset word (POW).

Setting Up the NCO FTW and POW

The NCO frequency value is given by the 12-bit two's complement number entered in the NCO FTW. Frequencies between $-f_s/2$ and $f_s/2$ ($f_s/2$ excluded) are represented using the following frequency words:

- 0x800 represents a frequency of $-f_s/2$.
- 0x000 represents dc (frequency is 0 Hz).
- 0x7FF represents a frequency of $+f_s/2 - f_s/2^{12}$.

The NCO frequency tuning word can be calculated using the following equation:

$$NCO_FTW = \text{round}\left(2^{12} \frac{\text{Mod}(f_c, f_s)}{f_s}\right)$$

where:

NCO_FTW is a 12-bit two's complement number representing the NCO FTW.

f_s is the AD9690 sampling frequency (clock rate) in Hz.

f_c is the desired carrier frequency in Hz.

$\text{Mod}()$ is a remainder function. For example, $\text{Mod}(110, 100) = 10$, and for negative numbers, $\text{Mod}(-32, 10) = -2$.

$\text{round}()$ is a rounding function. For example, $\text{round}(3.6) = 4$, and for negative numbers, $\text{round}(-3.4) = -3$.

Note that this equation applies to the aliasing of signals in the digital domain (that is, aliasing introduced when digitizing analog signals).

For example, if the ADC sampling frequency (f_s) is 1250 MSPS and the carrier frequency (f_c) is 416.667 MHz,

$$NCO_FTW = \text{round}\left(2^{12} \frac{\text{Mod}(416.667, 1250)}{1250}\right) = 1365 \text{ MHz}$$

This, in turn, converts to 0x555 in the 12-bit twos complement representation for NCO_FTW. The actual carrier frequency can be calculated based on the following equation:

$$f_c - \text{actual} = \frac{NCO_FTW \times f_s}{2^{12}} = 416.56 \text{ MHz}$$

A 12-bit POW is available for each NCO to create a known phase relationship between multiple AD9690 chips or individual DDC channels inside one AD9690.

The following procedure must be followed to update the FTW and/or POW registers to ensure proper operation of the NCO:

- Write to the FTW registers for all the DDCs.
- Write to the POW registers for all the DDCs.
- Synchronize the NCOs either through the DDC soft reset bit accessible through the SPI, or through the assertion of the SYSREF± pin.

Note that the NCOs must be synchronized either through SPI or through the SYSREF± pin after all writes to the FTW or POW registers have completed. This synchronization is necessary to ensure the proper operation of the NCO.

NCO Synchronization

Each NCO contains a separate phase accumulator word (PAW) that determines the instantaneous phase of the NCO. The initial reset value of each PAW is determined by the POW described in the Setting Up the NCO FTW and POW section. The phase increment value of each PAW is determined by the FTW.

Two methods can be used to synchronize multiple PAWs within the chip:

- Using the SPI. The DDC NCO soft reset bit in the DDC synchronization control register (Register 0x300, Bit 4) can be used to reset all the PAWs in the chip. This is accomplished by toggling the DDC NCO soft reset bit. This method can only be used to synchronize DDC channels within the same AD9690 chip.
- Using the SYSREF± pin. When the SYSREF± pin is enabled in the SYSREF± control registers (Register 0x120 and Register 0x121), and the DDC synchronization is enabled in Bits[1:0] in the DDC synchronization control register (Register 0x300), any subsequent SYSREF± event resets all the PAWs in the chip. This method can be used to synchronize DDC channels within the same AD9690 chip, or DDC channels within separate AD9690 chips.

Mixer

The NCO is accompanied by a mixer, whose operation is similar to an analog quadrature mixer. The mixer performs the downconversion of input signals (real or complex) by using the NCO frequency as a local oscillator. For real input signals, this mixer performs a real mixer operation (with two multipliers). For complex input signals, the mixer performs a complex mixer operation (with four multipliers and two adders). The mixer adjusts its operation based on the input signal (real or complex) provided to each individual channel. The selection of real or complex inputs can be controlled individually for each DDC block by using Bit 7 of the DDC control register (Register 0x310, and Register 0x330).

FIR FILTERS

GENERAL DESCRIPTION

There are four sets of decimate-by-2, low-pass, half-band, finite impulse response (FIR) filters (HB1 FIR, HB2 FIR, HB3 FIR, and HB4 FIR shown in Figure 88). These filters follow the frequency translation stage. After the carrier of interest is tuned down to dc (carrier frequency = 0 Hz), these filters efficiently lower the sample rate while providing sufficient alias rejection from unwanted adjacent carriers around the bandwidth of interest.

HB1 FIR is always enabled and cannot be bypassed. The HB2, HB3, and HB4 FIR filters are optional and can be bypassed for higher output sample rates.

Table 17 shows the different bandwidth options by including different half-band filters. In all cases, the DDC filtering stage of the AD9690 provides less than -0.001 dB of pass-band ripple and >100 dB of stop-band alias rejection.

Table 18 shows the amount of stop-band alias rejection for multiple pass-band ripple/cutoff points. The decimation ratio of the filtering stage of each DDC can be controlled individually through Bits[1:0] of the DDC control registers (0x310, and 0x330).

Table 17. DDC Filter Characteristics

ADC Sample Rate (MSPS)	Half-Band Filter Selection	Real Output		Complex (I/Q) Output		Alias Protected Bandwidth (MHz)	Ideal SNR Improvement (dB) ¹	Pass-Band Ripple (dB)	Alias Rejection (dB)
		Decimation Ratio	Output Sample Rate (MSPS)	Decimation Ratio	Output Sample Rate (MSPS)				
1000	HB1	1	1000	2	500 (I) + 500 (Q)	385.0	1	<-0.001	>100
	HB1 + HB2	2	500	4	250 (I) + 250 (Q)	192.5	4		
	HB1 + HB2 + HB3	4	250	8	125 (I) + 125 (Q)	96.3	7		
	HB1 + HB2 + HB3 + HB4	8	125	16	62.5 (I) + 62.5 (Q)	48.1	10		
500	HB1	1	500	2	250 (I) + 250 (Q)	192.5	1		
	HB1 + HB2	2	250	4	125 (I) + 125 (Q)	96.3	4		
	HB1 + HB2 + HB3	4	125	8	62.5 (I) + 62.5 (Q)	48.1	7		
	HB1 + HB2 + HB3 + HB4	8	62.5	16	31.25 (I) + 31.25 (Q)	24.1	10		

¹ Ideal SNR improvement due to oversampling and filtering = $10\log(\text{bandwidth}/(f_s/2))$.

Table 18. DDC Filter Alias Rejection

Alias Rejection (dB)	Pass-Band Ripple/Cutoff Point (dB)	Alias Protected Bandwidth for Real (I) Outputs ¹	Alias Protected Bandwidth for Complex (I/Q) Outputs ¹
>100	<-0.001	$<38.5\% \times f_{\text{OUT}}$	$<77\% \times f_{\text{OUT}}$
90	<-0.001	$<38.7\% \times f_{\text{OUT}}$	$<77.4\% \times f_{\text{OUT}}$
85	<-0.001	$<38.9\% \times f_{\text{OUT}}$	$<77.8\% \times f_{\text{OUT}}$
63.3	<-0.006	$<40\% \times f_{\text{OUT}}$	$<80\% \times f_{\text{OUT}}$
25	-0.5	$44.4\% \times f_{\text{OUT}}$	$88.8\% \times f_{\text{OUT}}$
19.3	-1.0	$45.6\% \times f_{\text{OUT}}$	$91.2\% \times f_{\text{OUT}}$
10.7	-3.0	$48\% \times f_{\text{OUT}}$	$96\% \times f_{\text{OUT}}$

¹ f_{OUT} is the ADC input sample rate f_s /DDC decimation ratio.

HALF-BAND FILTERS

The AD9690 offers four half-band filters to enable digital signal processing of the ADC converted data. The HB1 FIR is always enabled and cannot be bypassed. The HB2, HB3, and HB4 FIR filters are optional and can be bypassed for higher output sample rates.

HB4 Filter

The first decimate-by-2, half-band, low-pass FIR filter (HB4) uses an 11-tap, symmetrical, fixed-coefficient filter implementation, optimized for low power consumption. The HB4 filter is only used when complex outputs (decimate by 16) or real outputs (decimate by 8) are enabled; otherwise, the filter is bypassed. Table 19 and Figure 92 show the coefficients and response of the HB4 filter.

Table 19. HB4 Filter Coefficients

HB4 Coefficient Number	Normalized Coefficient	Decimal Coefficient (15-Bit)
C1, C11	0.006042	99
C2, C10	0	0
C3, C9	-0.049316	-808
C4, C8	0	0
C5, C7	0.293273	4805
C6	0.500000	8192

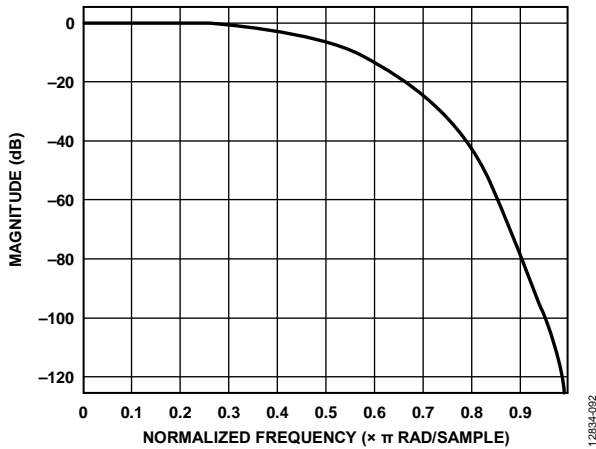

Figure 92. HB4 Filter Response

HB3 Filter

The second decimate-by-2, half-band, low-pass, FIR filter (HB3) uses an 11-tap, symmetrical, fixed coefficient filter implementation, optimized for low power consumption. The HB3 filter is only used when complex outputs (decimate by 8 or 16) or real outputs (decimate by 4 or 8) are enabled, otherwise, the filter is bypassed. Table 20 and Figure 93 show the coefficients and response of the HB3 filter.

Table 20. HB3 Filter Coefficients

HB3 Coefficient Number	Normalized Coefficient	Decimal Coefficient (18-Bit)
C1, C11	0.006554	859
C2, C10	0	0
C3, C9	-0.050819	-6661
C4, C8	0	0
C5, C7	0.294266	38,570
C6	0.500000	65,536

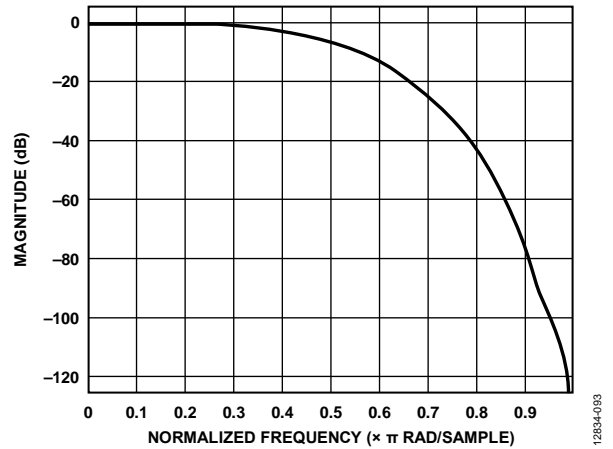

Figure 93. HB3 Filter Response

HB2 Filter

The third decimate-by-2, half-band, low-pass FIR filter (HB2) uses a 19-tap, symmetrical, fixed coefficient filter implementation that is optimized for low power consumption. The HB2 filter is only used when complex outputs (decimate by 4, 8, or 16) or real outputs (decimate by 2, 4, or 8) are enabled; otherwise, the filter is bypassed.

Table 21 and Figure 94 show the coefficients and response of the HB2 filter.

Table 21. HB2 Filter Coefficients

HB2 Coefficient Number	Normalized Coefficient	Decimal Coefficient (19-Bit)
C1, C19	0.000614	161
C2, C18	0	0
C3, C17	-0.005066	-1328
C4, C16	0	0
C5, C15	0.022179	5814
C6, C14	0	0
C7, C13	-0.073517	-19,272
C8, C12	0	0
C9, C11	0.305786	80,160
C10	0.500000	131,072

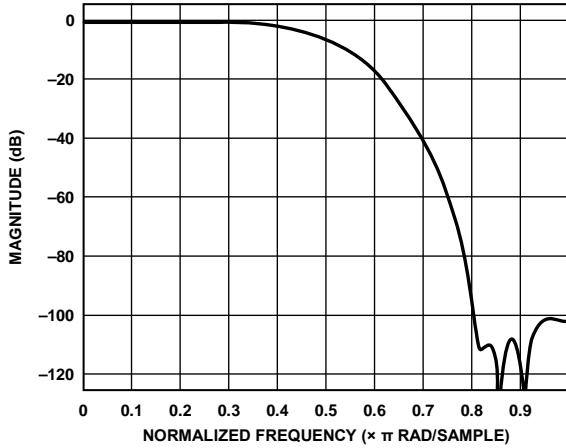

Figure 94. HB2 Filter Response

12834-094

HB1 Filter

The fourth and final decimate-by-2, half-band, low-pass FIR filter (HB1) uses a 55-tap, symmetrical, fixed coefficient filter implementation, optimized for low power consumption. The HB1 filter is always enabled and cannot be bypassed. Table 22 and Figure 95 show the coefficients and response of the HB1 filter.

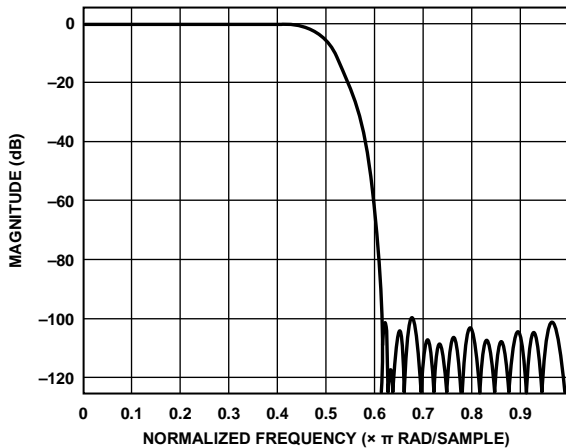

Figure 95. HB1 Filter Response

12834-095

Table 22. HB1 Filter Coefficients

HB1 Coefficient Number	Normalized Coefficient	Decimal Coefficient (21-Bit)
C1, C55	-0.000023	-24
C2, C54	0	0
C3, C53	0.000097	102
C4, C52	0	0
C5, C51	-0.000288	-302
C6, C50	0	0
C7, C49	0.000696	730
C8, C48	0	0
C9, C47	-0.0014725	-1544
C10, C46	0	0
C11, C45	0.002827	2964
C12, C44	0	0
C13, C43	-0.005039	-5284
C14, C42	0	0
C15, C41	0.008491	8903
C16, C40	0	0
C17, C39	-0.013717	-14,383
C18, C38	0	0
C19, C37	0.021591	22,640
C20, C36	0	0
C21, C35	-0.033833	-35,476
C22, C34	0	0
C23, C33	0.054806	57,468
C24, C32	0	0
C25, C31	-0.100557	-105,442
C26, C30	0	0
C27, C29	0.316421	331,792
C28	0.500000	524,288

DDC GAIN STAGE

Each DDC contains an independently controlled gain stage. The gain is selectable as either 0 dB or 6 dB. When mixing a real input signal down to baseband, it is recommended that the user enable the 6 dB of gain to recenter the dynamic range of the signal within the full scale of the output bits.

When mixing a complex input signal down to baseband, the mixer has already recentered the dynamic range of the signal within the full scale of the output bits and no additional gain is necessary. However, the optional 6 dB gain can be used to compensate for low signal strengths. The downsample by 2 portion of the HB1 FIR filter is bypassed when using the complex to real conversion stage (see Figure 96).

DDC COMPLEX—REAL CONVERSION

Each DDC contains an independently controlled complex to real conversion block. The complex to real conversion block reuses the last filter (HB1 FIR) in the filtering stage, along with an $f_s/4$ complex mixer to upconvert the signal.

After up converting the signal, the Q portion of the complex mixer is no longer needed and is dropped.

Figure 96 shows a simplified block diagram of the complex to real conversion.

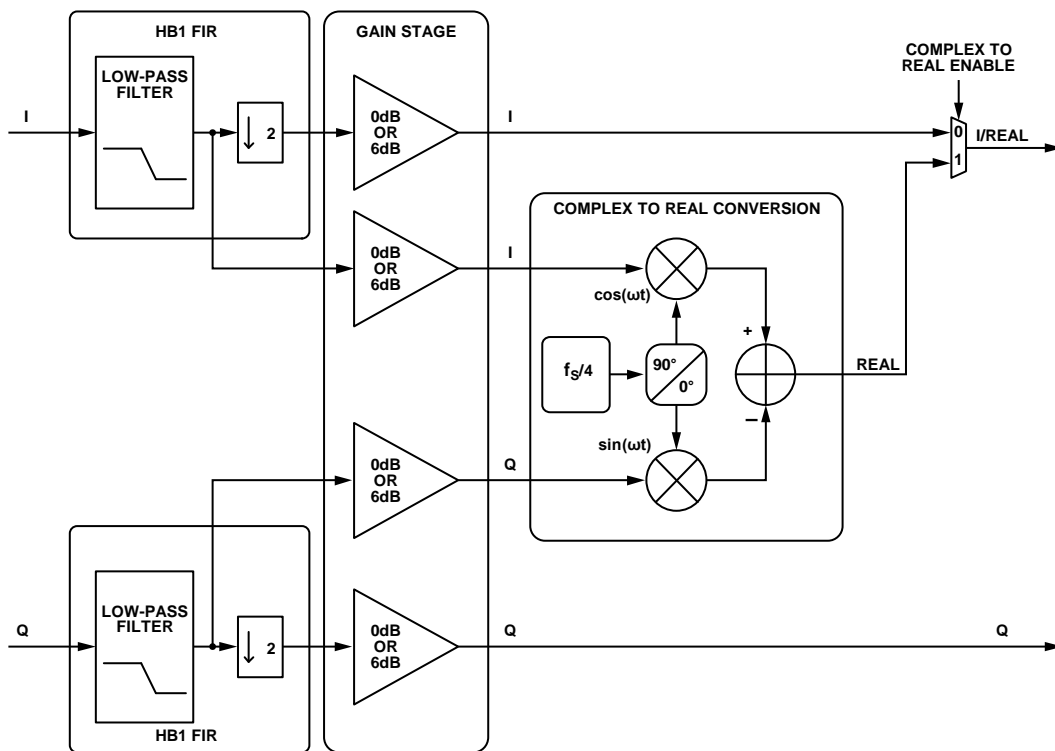

Figure 96. Complex to Real Conversion Block

12834-086

DDC EXAMPLE CONFIGURATIONS

Table 23 describes the register settings for multiple DDC example configurations.

Table 23. DDC Example Configurations

Chip Application Layer	Chip Decimation Ratio	DDC Input Type	DDC Output Type	Bandwidth per DDC ¹	No. of Virtual Converters Required	Register Settings ²
One DDC	2	Real	Complex	$38.5\% \times f_s$	2	Register 0x200 = 0x01 (one DDC; I/Q selected) Register 0x201 = 0x01 (chip decimate by 2) Register 0x310 = 0x83 (complex mixer; 0 dB gain; variable IF; complex outputs; HB1 filter) Register 0x311 = 0x00 (default) Register 0x331 = 0x00 (default) Register 0x314, Register 0x315, Register 0x320, Register 0x321 = FTW and POW set as required by application for DDC 0
Two DDCs	4	Real	Real	$9.63\% \times f_s$	2	Register 0x200 = 0x22 (two DDCs; I only selected) Register 0x201 = 0x02 (chip decimate by 4) Register 0x310, Register 0x330 = 0x49 (real mixer; 6 dB gain; variable IF; real output; HB3 + HB2 + HB1 filters) Register 0x311 = 0x00 (default) Register 0x331 = 0x00 (default) Register 0x314, Register 0x315, Register 0x320, Register 0x321 = FTW and POW set as required by application for DDC 0 Register 0x334, Register 0x335, Register 0x340, Register 0x341 = FTW and POW set as required by application for DDC 1
Two DDCs	4	Real	Complex	$19.25\% \times f_s$	4	Register 0x200 = 0x02 (two DDCs; I/Q selected) Register 0x201 = 0x02 (chip decimate by 4) Register 0x310, Register 0x330 = 0x40 (real mixer; 6 dB gain; variable IF; complex output; HB2+HB1 filters) Register 0x311 = 0x00 (default) Register 0x331 = 0x00 (default) Register 0x314, Register 0x315, Register 0x320, Register 0x321 = FTW and POW set as required by application for DDC 0 Register 0x334, Register 0x335, Register 0x340, Register 0x341 = FTW and POW set as required by application for DDC 1
Two DDCs	8	Real	Real	$4.81\% \times f_s$	2	Register 0x200 = 0x22 (two DDCs; I only selected) Register 0x201 = 0x03 (chip decimate by 8) Register 0x310, Register 0x330 = 0x4A (real mixer; 6 dB gain; variable IF; real output; HB4+HB3+HB2+HB1 filters) Register 0x311 = 0x00 (default) Register 0x331 = 0x00 (default) Register 0x314, Register 0x315, Register 0x320, Register 0x321 = FTW and POW set as required by application for DDC 0 Register 0x334, Register 0x335, Register 0x340, Register 0x341 = FTW and POW set as required by application for DDC 1

¹ f_s is the ADC sample rate. Bandwidths listed are <-0.001 dB of pass-band ripple and >100 dB of stop-band alias rejection.

² The NCOs must be synchronized either through the SPI or through the SYSREF \pm pin after all writes to the FTW or POW registers have completed, to ensure the proper operation of the NCO. See the NCO Synchronization section for more information.

DIGITAL OUTPUTS

INTRODUCTION TO THE JESD204B INTERFACE

The AD9690 digital outputs are designed to the JEDEC standard JESD204B, serial interface for data converters. JESD204B is a protocol to link the AD9690 to a digital processing device over a serial interface with lane rates of up to 12.5 Gbps. The benefits of the JESD204B interface over LVDS include a reduction in required board area for data interface routing, and an ability to enable smaller packages for converter and logic devices.

JESD204B OVERVIEW

The JESD204B data transmit block assembles the parallel data from the ADC into frames and uses 8-bit/10-bit encoding as well as optional scrambling to form serial output data. Lane synchronization is supported through the use of special control characters during the initial establishment of the link. Additional control characters are embedded in the data stream to maintain synchronization thereafter. A JESD204B receiver is required to complete the serial link. For additional details on the JESD204B interface, refer to the JESD204B standard.

The AD9690 JESD204B data transmit block maps one physical ADC or up to four virtual converters (when DDCs are enabled) over a link. A link can be configured to use one, two, or four JESD204B lanes. The JESD204B specification refers to a number of parameters to define the link, and these parameters must match between the JESD204B transmitter (the AD9690 output) and the JESD204B receiver (the logic device input).

The JESD204B link is described according to the following parameters:

- L is the number of lanes/converter device (lanes/link) (AD9690 value = 1, 2, or 4)
- M is the number of converters/converter device (virtual converters/link) (AD9690 value = 1, 2, or 4)
- F is the octets/frame (AD9690 value = 1, 2, 4, 8, or 16)
- N' is the number of bits per sample (JESD204B word size) (AD9690 value = 8 or 16)
- N is the converter resolution (AD9690 value = 7 to 16)

- CS is the number of control bits/sample (AD9690 value = 0, 1, 2, or 3)
- K is the number of frames per multiframe (AD9690 value = 4, 8, 12, 16, 20, 24, 28, or 32)
- S is the samples transmitted/single converter/frame cycle (AD9690 value = set automatically based on L, M, F, and N')
- HD is the high density mode (AD9690 = set automatically based on L, M, F, and N')
- CF is the number of control words/frame clock cycle/converter device (AD9690 value = 0)

Figure 97 shows a simplified block diagram of the AD9690 JESD204B link. By default, the AD9690-500 is configured to use one converter and two lanes, while the AD9690-1000 is configured to use one converter and four lanes. The AD9690 allows other configurations via a quick configuration register in the SPI register map, along with additional customizable options.

By default in the AD9690, the 14-bit converter word from each converter is broken into two octets (eight bits of data). Bit 13 (MSB) through Bit 6 are in the first octet. The second octet contains Bit 5 through Bit 0 (LSB) and two tail bits. The tail bits can be configured as zeroes or a pseudorandom number sequence. The tail bits can also be replaced with control bits indicating overrange, SYSREF±, or fast detect output.

The two resulting octets can be scrambled. Scrambling is optional; however, it is recommended to avoid spectral peaks when transmitting similar digital data patterns. The scrambler uses a self-synchronizing, polynomial-based algorithm defined by the equation $1 + x^{14} + x^{15}$. The descrambler in the receiver is a self-synchronizing version of the scrambler polynomial.

The two octets are then encoded with an 8-bit/10-bit encoder. The 8-bit/10-bit encoder works by taking eight bits of data (an octet) and encoding them into a 10-bit symbol. Figure 98 shows how the 14-bit data is taken from the ADC, how the tail bits are added, how the two octets are scrambled, and how the octets are encoded into two 10-bit symbols. Figure 98 illustrates the default data format when using the C2 control bit.

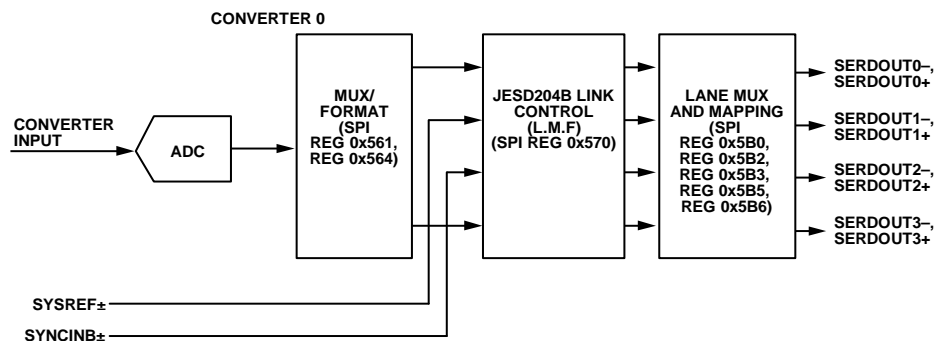

Figure 97. Transmit Link Simplified Block Diagram Showing Full Bandwidth Mode (Register 0x200 = 0x00)

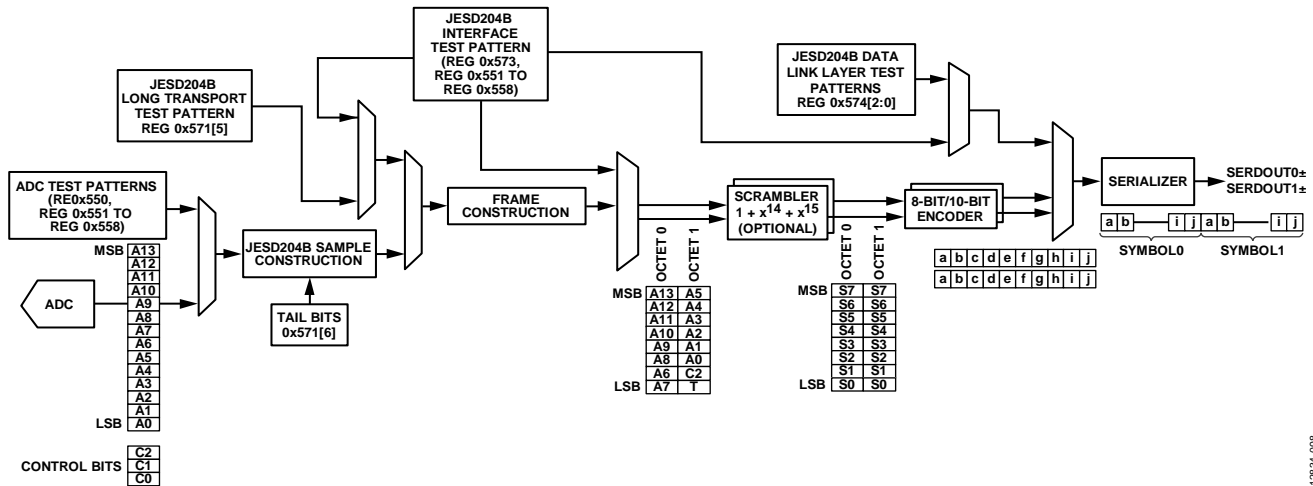

Figure 98. ADC Output Data Path Showing Data Framing

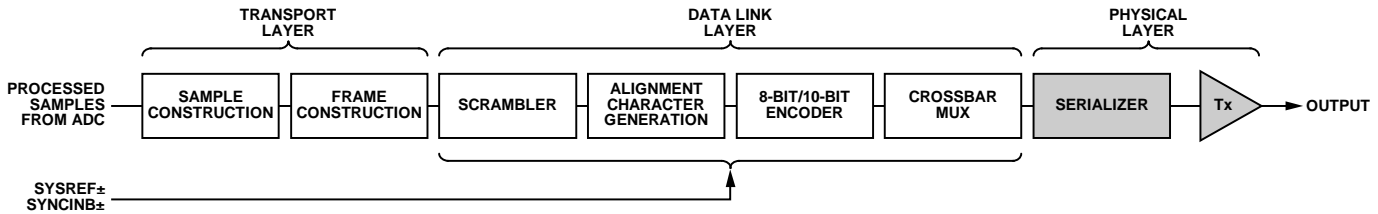

Figure 99. Data Flow

FUNCTIONAL OVERVIEW

The block diagram in Figure 99 shows the flow of data through the JESD204B hardware from the sample input to the physical output. The processing can be divided into layers that are derived from the open source initiative (OSI) model widely used to describe the abstraction layers of communications systems. These layers are the transport layer, data link layer, and physical layer (serializer and output driver).

Transport Layer

The transport layer handles packing the data (consisting of samples and optional control bits) into JESD204B frames that are mapped to 8-bit octets. These octets are sent to the data link layer. The transport layer mapping is controlled by rules derived from the link parameters. Tail bits are added to fill gaps where required. The following equation can be used to determine the number of tail bits within a sample (JESD204B word):

$$T = N' - N - CS$$

Data Link Layer

The data link layer is responsible for the low level functions of passing data across the link. These include optionally scrambling the data, inserting control characters for multichip synchronization/lane alignment/monitoring, and encoding 8-bit octets into 10-bit symbols. The data link layer is also responsible for sending the initial lane alignment sequence (ILAS), which contains the link configuration data used by the receiver to verify the settings in the transport layer.

Physical Layer

The physical layer consists of the high speed circuitry clocked at the serial clock rate. In this layer, parallel data is converted into one, two, or four lanes of high speed differential serial data.

JESD204B LINK ESTABLISHMENT

The AD9690 JESD204B transmitter (Tx) interface operates in Subclass 1 as defined in the JEDEC Standard 204B (July 2011 specification). The link establishment process is divided into the following steps: code group synchronization and SYNCINB±, initial lane alignment sequence, and user data and error correction.

Code Group Synchronization (CGS) and SYNCINB±

The CGS is the process by which the JESD204B receiver finds the boundaries between the 10-bit symbols in the stream of data. During the CGS phase, the JESD204B transmit block transmits $/K28.5/$ characters. The receiver must locate $/K28.5/$ characters in its input data stream using clock and data recovery (CDR) techniques.

The receiver issues a synchronization request by asserting the SYNCINB± pin of the AD9690 low. The JESD204B Tx then begins sending $/K/$ characters. Once the receiver has synchronized, it waits for the correct reception of at least four consecutive $/K/$ symbols. It then deasserts SYNCINB±. The AD9690 then transmits an ILAS on the following local multiframe clock (LMFC) boundary.

For more information on the code group synchronization phase, refer to the JEDEC Standard JESD204B, July 2011, Section 5.3.3.1.

The SYNCINB± pin operation can also be controlled by the SPI. The SYNCINB± signal is a differential dc-coupled LVDS mode signal by default, but it can also be driven single-ended. For more information on configuring the SYNCINB± pin operation, refer to Register 0x572.

The SYNCINB± pins can also be configured to run in CMOS (single-ended) mode, by setting Bit[4] in Register 0x572. When running SYNCINB± in CMOS mode, connect the CMOS SYNCINB signal to Pin 21 (SYNCINB+) and leave Pin 20 (SYNCINB-) floating.

Initial Lane Alignment Sequence (ILAS)

The ILAS phase follows the CGS phase and begins on the next LMFC boundary. The ILAS consists of four multiframes, with an /R/ character marking the beginning and an /A/ character marking the end. The ILAS begins by sending an /R/ character followed by 0 to 255 ramp data for one multiframe. On the second multiframe, the link configuration data is sent, starting with the third character. The second character is a /Q/ character to confirm that the link configuration data follows. All undefined data slots are filled with ramp data. The ILAS sequence is never scrambled.

The ILAS sequence construction is shown in Figure 100. The four multiframes include the following:

- Multiframe 1. Begins with an /R/ character (/K28.0/) and ends with an /A/ character (/K28.3/).
- Multiframe 2. Begins with an /R/ character followed by a /Q/ (/K28.4/) character, followed by link configuration parameters over 14 configuration octets (see Table 24) and ends with an /A/ character. Many of the parameter values are of the value - 1 notation.
- Multiframe 3. Begins with an /R/ character (/K28.0/) and ends with an /A/ character (/K28.3/).
- Multiframe 4. Begins with an /R/ character (/K28.0/) and ends with an /A/ character (/K28.3/).

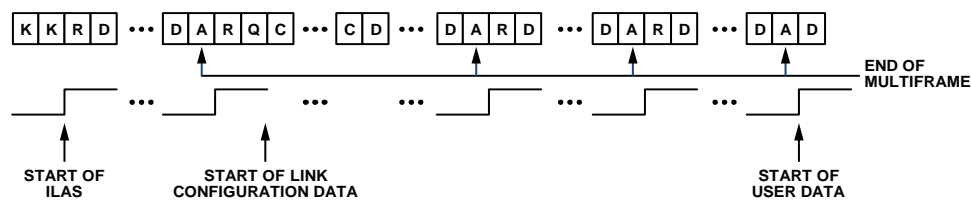

Figure 100. Initial Lane Alignment Sequence

User Data and Error Detection

After the initial lane alignment sequence is complete, the user data is sent. Normally, within a frame, all characters are considered user data. However, to monitor the frame clock and multiframe clock synchronization, there is a mechanism for replacing characters with /F/ or /A/ alignment characters when the data meets certain conditions. These conditions are different for unscrambled and scrambled data. The scrambling operation is enabled by default, but it may be disabled using the SPI.

For scrambled data, any 0xFC character at the end of a frame is replaced by an /F/, and any 0x7C character at the end of a multiframe is replaced with an /A/. The JESD204B receiver (Rx) checks for /F/ and /A/ characters in the received data stream and verifies that they only occur in the expected locations. If an unexpected /F/ or /A/ character is found, the receiver handles the situation by using dynamic realignment or asserting the SYNCINB± signal for more than four frames to initiate a resynchronization. For unscrambled data, if the final character of two subsequent frames is equal, the second character is replaced with an /F/ if it is at the end of a frame, and an /A/ if it is at the end of a multiframe.

Insertion of alignment characters can be modified using SPI. The frame alignment character insertion (FACI) is enabled by default. More information on the link controls is available in the Memory Map section, Register 0x571.

8-Bit/10-Bit Encoder

The 8-bit/10-bit encoder converts 8-bit octets into 10-bit symbols and inserts control characters into the stream when needed. The control characters used in JESD204B are shown in Table 24. The 8-bit/10-bit encoding ensures that the signal is dc balanced by using the same number of ones and zeroes across multiple symbols.

The 8-bit/10-bit interface has options that can be controlled via the SPI. These operations include bypass and invert. These options are troubleshooting tools for the verification of the digital front end (DFE). Refer to the Memory Map section, Register 0x572[2:1] for information on configuring the 8-bit/10-bit encoder.

Table 24. AD9690 Control Characters used in JESD204B

Abbreviation	Control Symbol	8-Bit Value	10-Bit Value, RD ¹ = -1	10-Bit Value, RD ¹ = +1	Description
/R/	/K28.0/	000 11100	001111 0100	110000 1011	Start of multiframe
/A/	/K28.3/	011 11100	001111 0011	110000 1100	Lane alignment
/Q/	/K28.4/	100 11100	001111 0100	110000 1101	Start of link configuration data
/K/	/K28.5/	101 11100	001111 1010	110000 0101	Group synchronization
/F/	/K28.7/	111 11100	001111 1000	110000 0111	Frame alignment

¹ RD = running disparity.

PHYSICAL LAYER (DRIVER) OUTPUTS

Digital Outputs, Timing, and Controls

The AD9690 physical layer consists of drivers that are defined in the JEDEC Standard JESD204B, July 2011. The differential digital outputs are powered up by default. The drivers use a dynamic 100 Ω internal termination to reduce unwanted reflections.

Place a 100 Ω differential termination resistor at each receiver input to result in a nominal 300 mV p-p swing at the receiver (see Figure 101). Alternatively, single-ended 50 Ω termination can be used. When single-ended termination is used, the termination voltage is DRVDD/2. Otherwise, 0.1 μ F ac coupling capacitors can be used to terminate to any single-ended voltage.

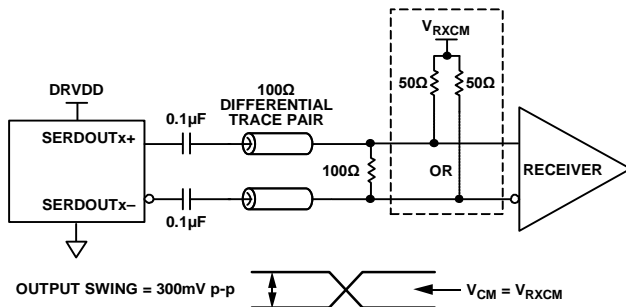

Figure 101. AC-Coupled Digital Output Termination Example

The AD9690 digital outputs can interface with custom ASICs and FPGA receivers, providing superior switching performance in noisy environments. Single point-to-point network topologies are recommended with a single differential 100 Ω termination resistor placed as close to the receiver inputs as possible. The common mode of the digital output automatically biases itself to half the DRVDD supply of 1.2 V ($V_{CM} = 0.6$ V). See Figure 102 for dc coupling the outputs to the receiver logic.

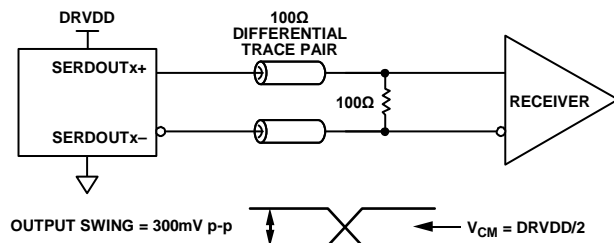

Figure 102. DC-Coupled Digital Output Termination Example

If there is no far-end receiver termination, or if there is poor differential trace routing, timing errors can result. To avoid such timing errors, it is recommended that the trace length be less than six inches, and that the differential output traces be close together and at equal lengths.

Figure 103 to Figure 108 show an example of the digital output data eye, time interval error (TIE) jitter histogram, and bathtub curve for one AD9690 lane running at 10 Gbps and 6 Gbps, respectively. The format of the output data is twos complement by default. To change the output data format, see the Memory Map section (Register 0x561 in Table 36).

De-Emphasis

De-emphasis enables the receiver eye diagram mask to be met in conditions where the interconnect insertion loss does not meet the JESD204B specification. Use the de-emphasis feature only when the receiver is unable to recover the clock due to excessive insertion loss. Under normal conditions, it is disabled to conserve power. Additionally, enabling and setting too high a de-emphasis value on a short link can cause the receiver eye diagram to fail. Use the de-emphasis setting with caution because it can increase electromagnetic interference (EMI). See the Memory Map section (Register 0x5C1 to Register 0x5C5 in Table 36) for more details.

Phase-Locked Loop

The phase-locked loop (PLL) is used to generate the serializer clock, which operates at the JESD204B lane rate. The status of the PLL lock can be checked in the PLL locked status bit (Register 0x56F, Bit 7). This read only bit lets the user know if the PLL has achieved a lock for the specific setup. The JESD204B lane rate control, Bit 4 of Register 0x56E, must be set to correspond with the lane rate.

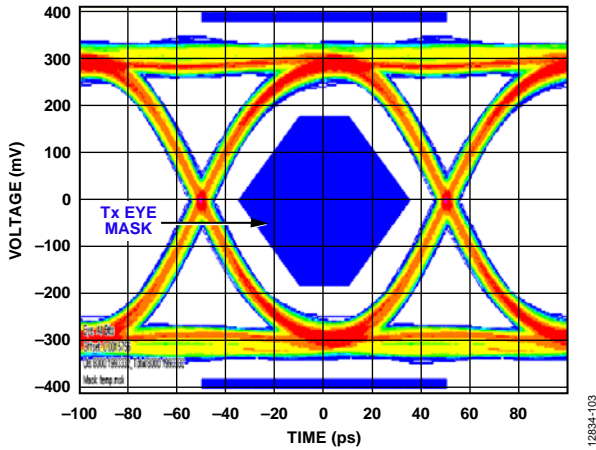

Figure 103. Digital Outputs Data Eye, External 100 Ω Terminations at 10 Gbps

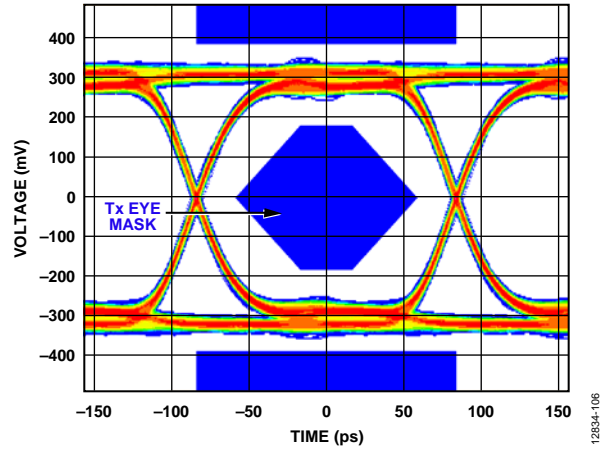

Figure 106. Digital Outputs Data Eye, External 100 Ω Terminations at 6 Gbps

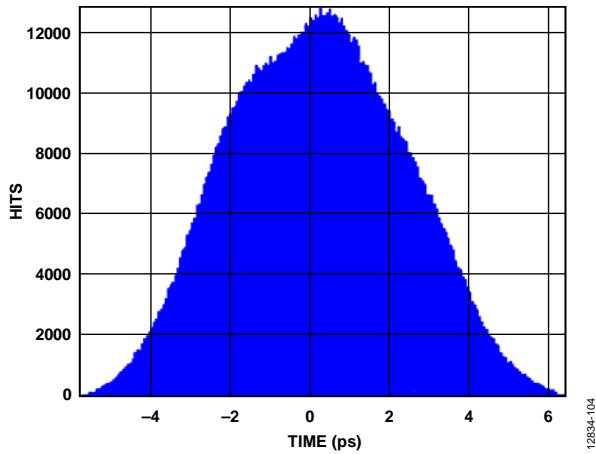

Figure 104. Digital Outputs Histogram, External 100 Ω Terminations at 10 Gbps

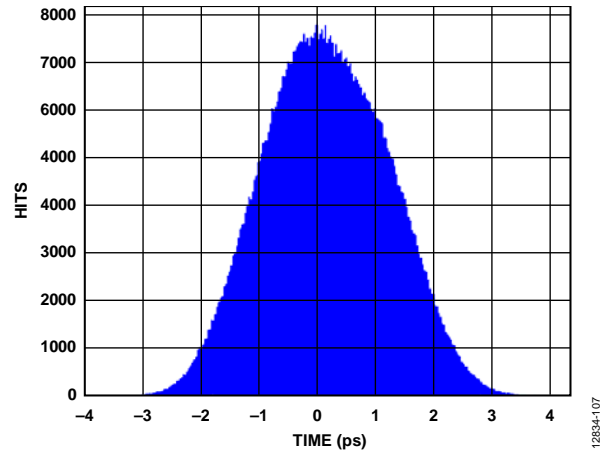

Figure 107. Digital Outputs Histogram, External 100 Ω Terminations at 6 Gbps

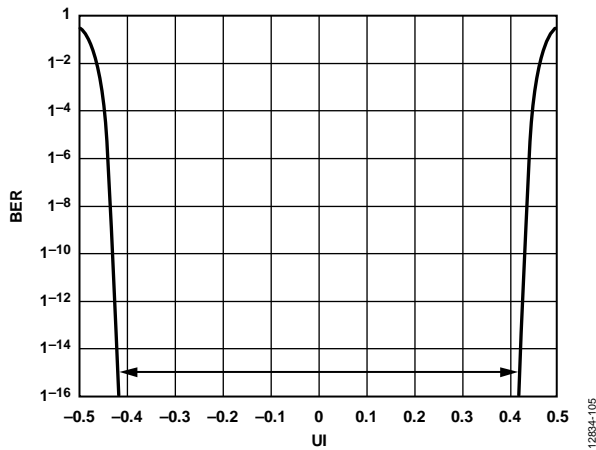

Figure 105. Digital Outputs Bathtub Curve, External 100 Ω Terminations at 10 Gbps

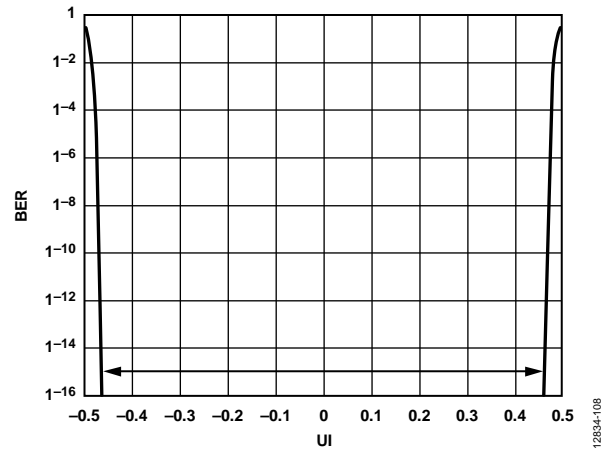

Figure 108. Digital Outputs Bathtub Curve, External 100 Ω Terminations at 6 Gbps

JESD204B Tx CONVERTER MAPPING

To support the different chip operating modes, the AD9690 design treats each sample stream (real or I/Q) as originating from separate virtual converters. The I/Q samples are always mapped in pairs with the I samples mapped to the first virtual converter and the Q samples mapped to the second virtual converter. With this transport layer mapping, the number of virtual converters are the same whether

- A single real converter is used along with a digital downconverter block producing I/Q outputs, or
- An analog downconversion is used with two real converters producing I/Q outputs.

Figure 109 shows a block diagram of the two scenarios described for I/Q transport layer mapping.

The JESD204B Tx block for AD9690 supports up to four DDC blocks. Each DDC block outputs either two sample streams (I/Q) for the complex data components (real + imaginary), or one sample stream for real (I) data. The JESD204B interface can be configured to use up to four virtual converters depending on the DDC configuration. Figure 110 shows the virtual converters and their relationship to the DDC outputs when complex outputs are used. Table 25 shows the virtual converter mapping for each chip operating mode when channel swapping is disabled.

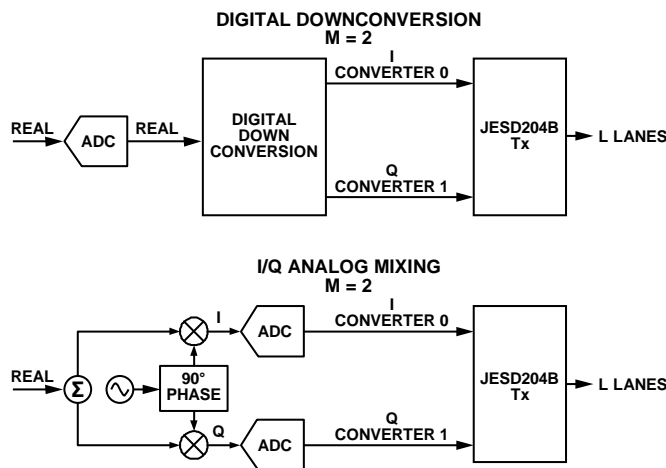

Figure 109. I/Q Transport Layer Mapping

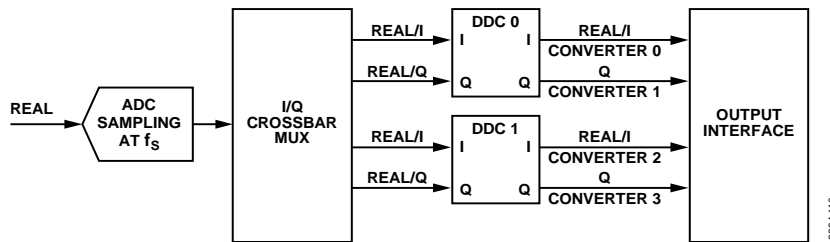

Figure 110. DDCs and Virtual Converter Mapping

Table 25. Virtual Converter Mapping

Number of Virtual Converters Supported	Chip Operating Mode (0x200, Bits[1:0])	Chip Q Ignore (0x200, Bit 5)	Virtual Converter Mapping								
			0	1	2	3	4	5	6	7	
1	Full bandwidth mode (0x0)	Real (0x0)	ADC samples	Unused	Unused	Unused	Unused	Unused	Unused	Unused	Unused
1	One DDC mode (0x1)	Real (I only) (0x1)	DDC 0 I samples	Unused	Unused	Unused	Unused	Unused	Unused	Unused	Unused
2	One DDC mode (0x1)	Complex (I/Q) (0x0)	DDC 0 I samples	DDC 0 Q samples	Unused	Unused	Unused	Unused	Unused	Unused	Unused
2	Two DDC mode (0x2)	Real (I Only) (0x1)	DDC 0 I samples	DDC 1 I samples	Unused	Unused	Unused	Unused	Unused	Unused	Unused
4	Two DDC mode (0x2)	Complex (I/Q) (0x0)	DDC 0 I samples	DDC 0 Q samples	DDC 1 I samples	DDC 1 Q samples	Unused	Unused	Unused	Unused	Unused

CONFIGURING THE JESD204B LINK

The AD9690 has one JESD204B link. The device offers an easy way to set up the JESD204B link through the JESD04B quick configuration register (Register 0x570). The serial outputs (SERDOUT0± to SERDOUT3±) are considered to be part of one JESD204B link. The basic parameters that determine the link setup are

- Number of lanes per link (L)
- Number of converters per link (M)
- Number of octets per frame (F)

If the internal DDCs are used for on-chip digital processing, M represents the number of virtual converters. The virtual converter mapping setup is shown in Figure 110.

The maximum lane rate allowed by the JESD204B specification is 12.5 Gbps. The lane line rate is related to the JESD204B parameters using the following equation:

$$\text{Lane Line Rate} = \frac{M \times N' \times \left(\frac{10}{8}\right) \times f_{OUT}}{L}$$

where:

$$f_{OUT} = \frac{f_{ADC_CLOCK}}{\text{Decimation Ratio}}$$

The decimation ratio (DCM) is the parameter programmed in Register 0x201.

The following steps can be used to configure the output:

1. Power down the link.
2. Select quick configuration options.
3. Configure detailed options
4. Set output lane mapping (optional).
5. Set additional driver configuration options (optional).
6. Power up the link.

If the lane line rate calculated is less than 6.25 Gbps, select the low line rate option. This is done by programming a value of 0x10 to Register 0x56E.

Table 26 and Table 27 show the JESD204B output configurations supported for both $N' = 16$ and $N' = 8$ for a given number of virtual converters. Care must be taken to ensure that the serial line rate for a given configuration is within the supported range of 3.125 Gbps to 12.5 Gbps.

Table 26. JESD204B Output Configurations for N'=16

Number of Virtual Converters Supported (Same Value as M)	JESD204B Quick Configuration (0x570)	JESD204B Serial Line Rate ¹	JESD204B Transport Layer Settings ²								
			L	M	F	S	HD	N	N'	CS	K ³
1	0x01	20 × f _{OUT}	1	1	2	1	0	8 to 16	16	0 to 3	Only valid K values that are divisible by 4 are supported
	0x40	10 × f _{OUT}	2	1	1	1	1	8 to 16	16	0 to 3	
	0x41	10 × f _{OUT}	2	1	2	2	0	8 to 16	16	0 to 3	
	0x80	5 × f _{OUT}	4	1	1	2	1	8 to 16	16	0 to 3	
	0x81	5 × f _{OUT}	4	1	2	4	0	8 to 16	16	0 to 3	
2	0x0A	40 × f _{OUT}	1	2	4	1	0	8 to 16	16	0 to 3	
	0x49	20 × f _{OUT}	2	2	2	1	0	8 to 16	16	0 to 3	
	0x88	10 × f _{OUT}	4	2	1	1	1	8 to 16	16	0 to 3	
	0x89	10 × f _{OUT}	4	2	2	2	0	8 to 16	16	0 to 3	
4	0x13	80 × f _{OUT}	1	4	8	1	0	8 to 16	16	0 to 3	
	0x52	40 × f _{OUT}	2	4	4	1	0	8 to 16	16	0 to 3	
	0x91	20 × f _{OUT}	4	4	2	1	0	8 to 16	16	0 to 3	

¹ f_{OUT} = output sample rate = ADC sample rate/chip decimation ratio. The JESD204B serial line rate must be ≥3125 Mbps and ≤12,500 Mbps; when the serial line rate is ≤12.5 Gbps and ≥6.25 Gbps, the low line rate mode must be disabled (set Bit 4 to 0x0 in 0x56E). When the serial line rate is <6.25 Gbps and ≥3.125 Gbps, the low line rate mode must be enabled (set Bit 4 to 0x1 in 0x56E).

² JESD204B transport layer descriptions are as described in the JESD204B Overview section.

³ For F = 1, K = 20, 24, 28, and 32. For F = 2, K = 12, 16, 20, 24, 28, and 32. For F = 4, K = 8, 12, 16, 20, 24, 28, and 32. For F = 8 and F = 16, K = 4, 8, 12, 16, 20, 24, 28, and 32.

Table 27. JESD204B Output Configurations for N'=8

Number of Virtual Converters Supported (Same Value as M)	JESD204B Quick Configuration (0x570)	Serial Line Rate ¹	JESD204B Transport Layer Settings ²								
			L	M	F	S	HD	N	N'	CS	K ³
1	0x00	10 × f _{OUT}	1	1	1	1	0	7 to 8	8	0 to 1	Only valid K values which are divisible by 4 are supported
	0x01	10 × f _{OUT}	1	1	2	2	0	7 to 8	8	0 to 1	
	0x40	5 × f _{OUT}	2	1	1	2	0	7 to 8	8	0 to 1	
	0x41	5 × f _{OUT}	2	1	2	4	0	7 to 8	8	0 to 1	
	0x42	5 × f _{OUT}	2	1	4	8	0	7 to 8	8	0 to 1	
	0x80	2.5 × f _{OUT}	4	1	1	4	0	7 to 8	8	0 to 1	
	0x81	2.5 × f _{OUT}	4	1	2	8	0	7 to 8	8	0 to 1	
2	0x09	20 × f _{OUT}	1	2	2	1	0	7 to 8	8	0 to 1	
	0x48	10 × f _{OUT}	2	2	1	1	0	7 to 8	8	0 to 1	
	0x49	10 × f _{OUT}	2	2	2	2	0	7 to 8	8	0 to 1	
	0x88	5 × f _{OUT}	4	2	1	2	0	7 to 8	8	0 to 1	
	0x89	5 × f _{OUT}	4	2	2	4	0	7 to 8	8	0 to 1	
	0x8A	5 × f _{OUT}	4	2	4	8	0	7 to 8	8	0 to 1	

¹ f_{OUT} = output sample rate = ADC sample rate/chip decimation ratio. The JESD204B serial line rate must be ≥3125 Mbps and ≤12,500 Mbps; when the serial line rate is ≤12.5 Gbps and ≥6.25 Gbps, the low line rate mode must be disabled (set Bit 4 to 0x0 in Register 0x56E). When the serial line rate is <6.25 Gbps and ≥3.125 Gbps, the low line rate mode must be enabled (set Bit 4 to 0x1 in Register 0x56E).

² JESD204B transport layer descriptions are as described in the JESD204B Overview section.

³ For F = 1, K = 20, 24, 28, and 32. For F = 2, K = 12, 16, 20, 24, 28, and 32. For F = 4, K = 8, 12, 16, 20, 24, 28, and 32. For F = 8 and F = 16, K = 4, 8, 12, 16, 20, 24, 28, and 32.

MULTICHIP SYNCHRONIZATION

The AD9690 has a SYSREF \pm input that provides flexible options for synchronizing the internal blocks. The SYSREF \pm input is a source synchronous system reference signal that enables multichip synchronization. The input clock divider, DDCs, signal monitor block, and JESD204B link can be synchronized using the SYSREF \pm input. For the highest level of timing accuracy, SYSREF \pm must meet setup and hold requirements relative to the CLK \pm input.

The flowchart in Figure 111 describes the internal mechanism for multichip synchronization in the AD9690. The AD9690 supports several features that aid users in meeting the requirements set out for capturing a SYSREF \pm signal. The SYSREF sample event can be defined as either a synchronous low to high transition, or a synchronous high to low transition. Additionally, the AD9690 allows the SYSREF signal to be sampled using either the rising edge or falling edge of the CLK \pm input. The AD9690 also has the ability to ignore a programmable number (up to 16) of SYSREF \pm events. The SYSREF \pm control options can be selected using Register 0x120 and Register 0x121.

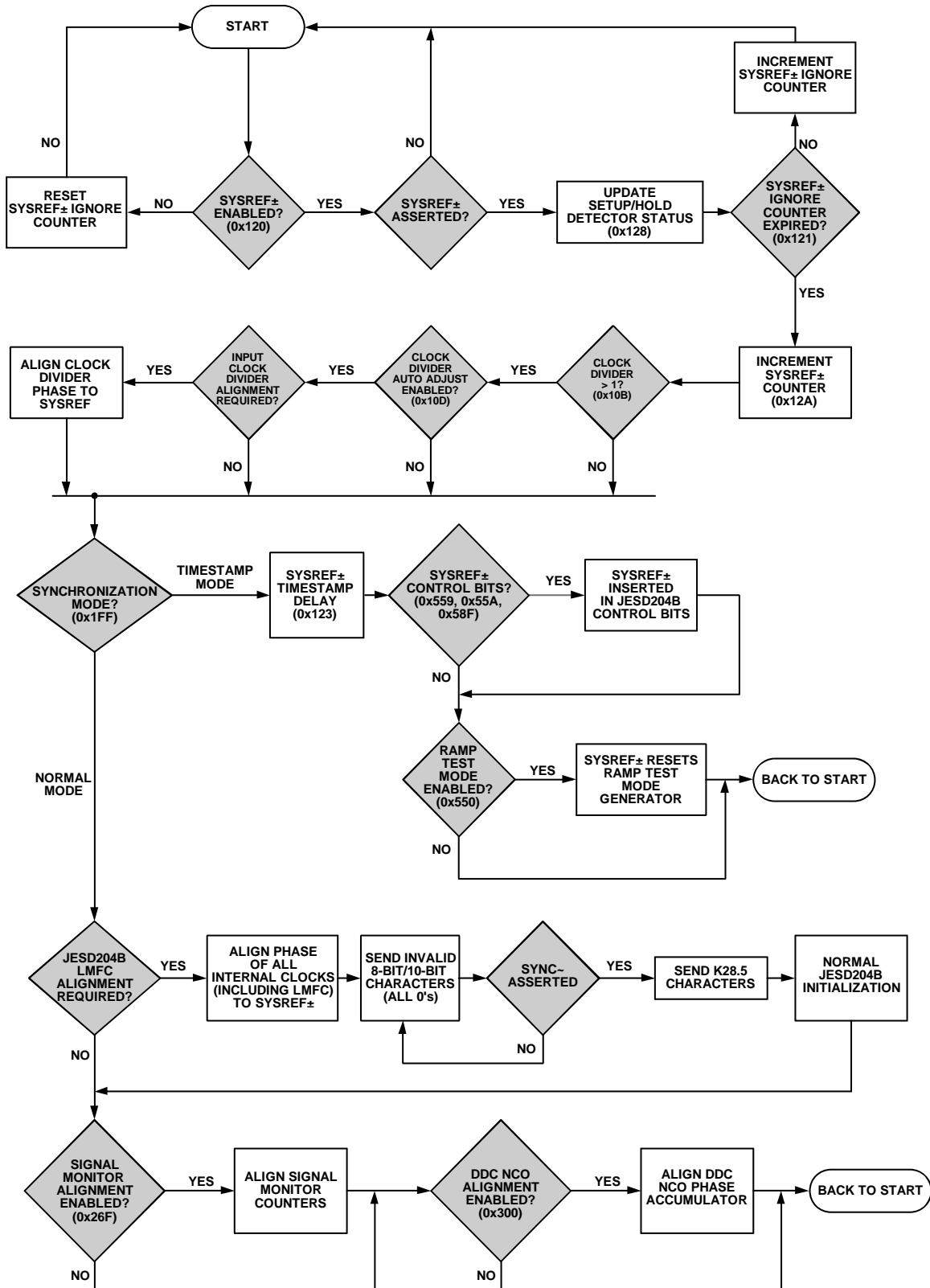

Figure 111. Multichip Synchronization

12534-111

SYSREF± SETUP/HOLD WINDOW MONITOR

To ensure a valid SYSREF signal capture, the AD9690 has a SYSREF± setup/hold window monitor. This feature allows the system designer to determine the location of the SYSREF± signals relative to the CLK± signals by reading back the amount of setup/hold margin on the interface through the memory map.

Figure 112 and Figure 113 show the setup and hold status values for different phases of SYSREF±. The setup detector returns the status of the SYSREF± signal before the CLK± edge and the hold detector returns the status of the SYSREF signal after the CLK± edge. Register 0x128 stores the status of SYSREF± and lets the user know if the SYSREF± signal is captured by the ADC.

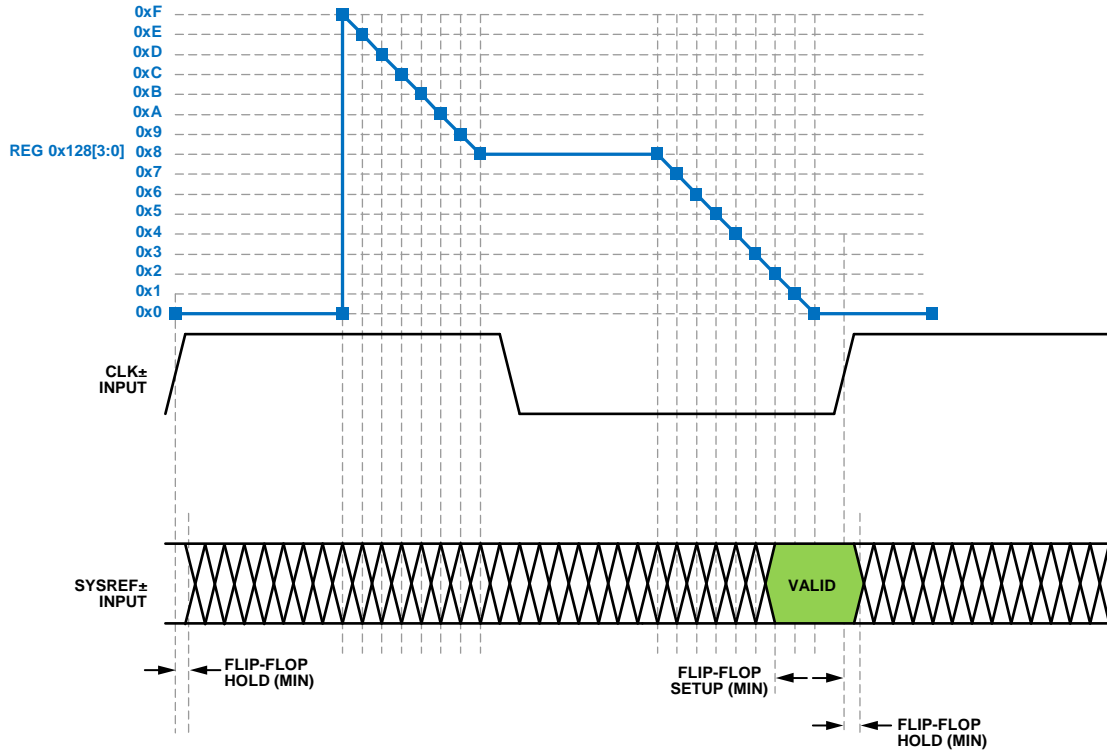

Figure 112. SYSREF± Setup Detector

12834-112

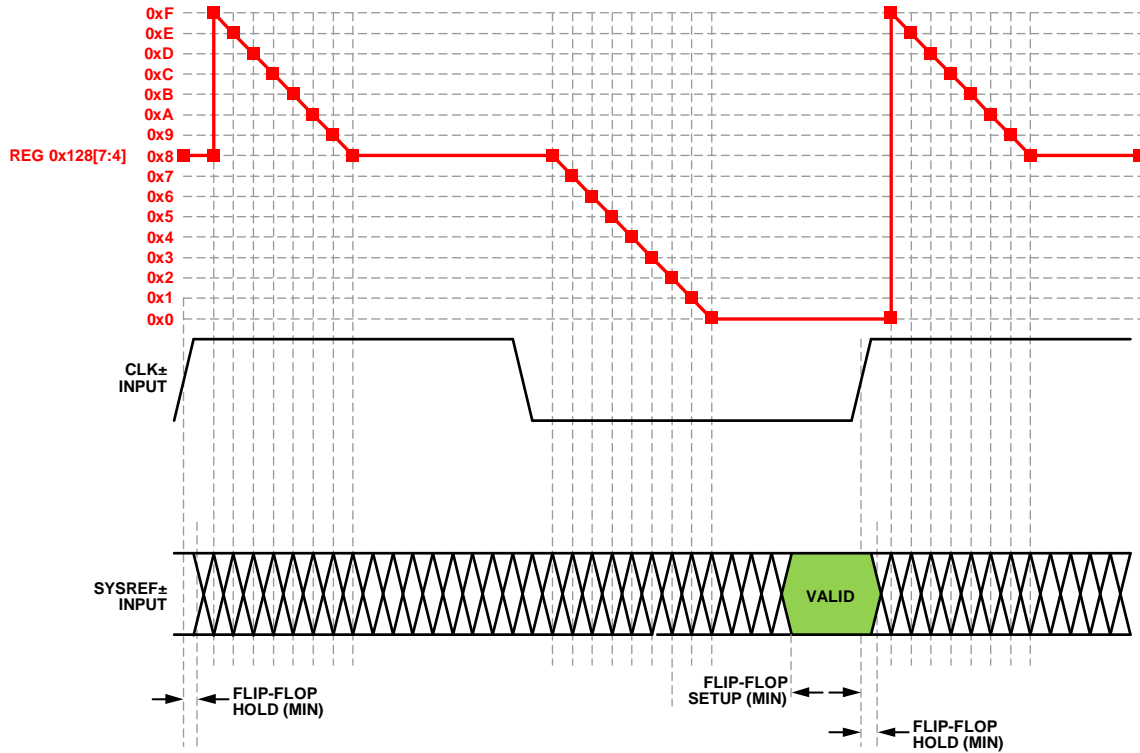

Figure 113. SYSREF± Hold Detector

Table 28 shows the description of the contents of Register 0x128 and how to interpret them.

Table 28. SYSREF± Setup/Hold Monitor, Register 0x128

Register 0x128[7:4] Hold Status	Register 0x128[3:0] Setup Status	Description
0x0	0x0 to 0x7	Possible setup error. The smaller this number, the smaller the setup margin.
0x0 to 0x8	0x8	No setup or hold error (best hold margin).
0x8	0x9 to 0xF	No setup or hold error (best setup and hold margin).
0x8	0x0	No setup or hold error (best setup margin).
0x9 to 0xF	0x0	Possible hold error. The larger this number, the smaller the hold margin.
0x0	0x0	Possible setup or hold error.

TEST MODES

ADC TEST MODES

The AD9690 has various test options that aid in the system level implementation. The AD9690 has ADC test modes that are available in Register 0x550. These test modes are described in Table 29. When an output test mode is enabled, the analog section of the ADC is disconnected from the digital back-end blocks, and the test pattern is run through the output formatting block.

Some of the test patterns are subject to output formatting, and some are not. The PN generators from the PN sequence tests can be reset by setting Bit 4 or Bit 5 of Register 0x550. These tests can be performed with or without an analog signal (if present, the analog signal is ignored); however, they do require an encode clock. For more information, see the [AN-877 Application Note, Interfacing to High Speed ADCs via SPI](#).

Table 29. ADC Test Modes¹

Output Test Mode Bit Sequence	Pattern Name	Expression	Default/Seed Value	Sample (N, N + 1, N + 2, ...)
0000	Off (default)	N/A	N/A	N/A
0001	Midscale short	00 0000 0000 0000	N/A	N/A
0010	+Full-scale short	01 1111 1111 1111	N/A	N/A
0011	–Full-scale short	10 0000 0000 0000	N/A	N/A
0100	Checkerboard	10 1010 1010 1010	N/A	0x1555, 0x2AAA, 0x1555, 0x2AAA, 0x1555
0101	PN sequence long	$X^{23} + X^{18} + 1$	0x3AFF	0x3FD7, 0x0002, 0x26E0, 0x0A3D, 0x1CA6
0110	PN sequence short	$X^9 + X^5 + 1$	0x0092	0x125B, 0x3C9A, 0x2660, 0x0c65, 0x0697
0111	One-/zero-word toggle	11 1111 1111 1111	N/A	0x0000, 0x3FFF, 0x0000, 0x3FFF, 0x0000
1000	User input	Register 0x551 to Register 0x558	N/A	User Pat 1[15:2], User Pat 2[15:2], User Pat 3[15:2], User Pat 4[15:2], User Pat 1[15:2] ... for repeat mode User Pat 1[15:2], User Pat 2[15:2], User Pat 3[15:2], User Pat 4[15:2], 0x0000 ... for single mode
1111	Ramp Output	$(X) \% 2^{14}$	N/A	$(X) \% 2^{14}, (X + 1) \% 2^{14}, (X + 2) \% 2^{14}, (X + 3) \% 2^{14}$

¹ N/A means not applicable.

JESD204B BLOCK TEST MODES

In addition to the ADC pipeline test modes, the AD9690 also has flexible test modes in the JESD204B block. These test modes are listed in Register 0x573 and Register 0x574. These test patterns can be injected at various points along the output data path. These test injection points are shown in Figure 98. Table 30 describes the various test modes available in the JESD204B block. For the AD9690, a transition from test modes (Register 0x573 \neq 0x00) to normal mode (Register 0x573 = 0x00) requires an SPI soft reset. This is done by writing 0x81 to Register 0x00 (self cleared).

Transport Layer Sample Test Mode

The transport layer samples are implemented in the AD9690 as defined by section 5.1.6.3 in the JEDEC JESD204B Specification.

These tests are shown in Register 0x571[5]. The test pattern is equivalent to the raw samples from the ADC.

Interface Test Modes

The interface test modes are described in Register 0x573 Bits[3:0]. These test modes are also explained in Table 30. The interface tests can be injected at various points along the data. See Figure 98 for more information on the test injection points. Register 0x573 Bits[5:4] show where these tests are injected.

Table 31, Table 32, and Table 33 show examples of some of the test modes when injected at the JESD Sample Input, PHY 10-bit Input, and Scrambler 8-bit Input. UP in the tables represent the user pattern control bits from the customer register map.

Table 30. JESD204B Interface Test Modes

Output Test Mode Bit Sequence	Pattern Name	Expression	Default
0000	Off (default)	Not applicable	Not applicable
0001	Alternating checker board	0x5555, 0xAAAA, 0x5555, ...	Not applicable
0010	1/0 word toggle	0x0000, 0xFFFF, 0x0000, ...	Not applicable
0011	31-bit PN sequence	$X^{31} + X^{28} + 1$	0x0003AFFF
0100	23-bit PN sequence	$X^{23} + X^{18} + 1$	0x003AFF
0101	15-bit PN sequence	$X^{15} + X^{14} + 1$	0x03AF
0110	9-bit PN sequence	$X^9 + X^5 + 1$	0x092
0111	7-bit PN sequence	$X^7 + X^6 + 1$	0x07
1000	Ramp output	$(X) \% 2^{16}$	Ramp size depends on test injection point
1110	Continuous/repeat user test	Register 0x551 to Register 0x558	User Pat 1 to User Pat 4, then repeat
1111	Single user test	Register 0x551 to Register 0x558	User Pat 1 to User Pat 4, then zeroes

Table 31. JESD204B Sample Input for M=1, S=2, N'=16 (Register 0x573[5:4]='b00)

Frame Number	Converter Number	Sample Number	Alternating Checkerboard	1/0 Word Toggle	Ramp	PN9	PN23	User Repeat	User Single
0	0	0	0x5555	0x0000	$(X) \% 2^{16}$	0x496F	0xFF5C	UP1[15:0]	UP1[15:0]
0	0	1	0x5555	0x0000	$(X) \% 2^{16}$	0x496F	0xFF5C	UP1[15:0]	UP1[15:0]
1	0	0	0xAAAA	0xFFFF	$(X + 1) \% 2^{16}$	0xC9A9	0x0029	UP2[15:0]	UP2[15:0]
1	0	1	0xAAAA	0xFFFF	$(X + 1) \% 2^{16}$	0xC9A9	0x0029	UP2[15:0]	UP2[15:0]
2	0	0	0x5555	0x0000	$(X + 2) \% 2^{16}$	0x980C	0xB80A	UP3[15:0]	UP3[15:0]
2	0	1	0x5555	0x0000	$(X + 2) \% 2^{16}$	0x980C	0xB80A	UP3[15:0]	UP3[15:0]
3	0	0	0xAAAA	0xFFFF	$(X + 3) \% 2^{16}$	0x651A	0x3D72	UP4[15:0]	UP4[15:0]
3	0	1	0xAAAA	0xFFFF	$(X + 3) \% 2^{16}$	0x651A	0x3D72	UP4[15:0]	UP4[15:0]
4	0	0	0x5555	0x0000	$(X + 4) \% 2^{16}$	0x5FD1	0x9B26	UP1[15:0]	0x0000
4	0	1	0x5555	0x0000	$(X + 4) \% 2^{16}$	0x5FD1	0x9B26	UP1[15:0]	0x0000

Table 32. Physical Layer 10-bit Input (Register 0x573[5:4]='b01)

10-Bit Symbol Number	Alternating Checkerboard	1/0 Word Toggle	Ramp	PN9	PN23	User Repeat	User Single
0	0x155	0x000	$(X) \% 2^{10}$	0x125	0x3FD	UP1[15:6]	UP1[15:6]
1	0x2AA	0x3FF	$(X + 1) \% 2^{10}$	0x2FC	0x1C0	UP2[15:6]	UP2[15:6]
2	0x155	0x000	$(X + 2) \% 2^{10}$	0x26A	0x00A	UP3[15:6]	UP3[15:6]
3	0x2AA	0x3FF	$(X + 3) \% 2^{10}$	0x198	0x1B8	UP4[15:6]	UP4[15:6]
4	0x155	0x000	$(X + 4) \% 2^{10}$	0x031	0x028	UP1[15:6]	0x000
5	0x2AA	0x3FF	$(X + 5) \% 2^{10}$	0x251	0x3D7	UP2[15:6]	0x000
6	0x155	0x000	$(X + 6) \% 2^{10}$	0x297	0x0A6	UP3[15:6]	0x000
7	0x2AA	0x3FF	$(X + 7) \% 2^{10}$	0x3D1	0x326	UP4[15:6]	0x000
8	0x155	0x000	$(X + 8) \% 2^{10}$	0x18E	0x10F	UP1[15:6]	0x000
9	0x2AA	0x3FF	$(X + 9) \% 2^{10}$	0x2CB	0x3FD	UP2[15:6]	0x000
10	0x155	0x000	$(X + 10) \% 2^{10}$	0x0F1	0x31E	UP3[15:6]	0x000
11	0x2AA	0x3FF	$(X + 11) \% 2^{10}$	0x3DD	0x008	UP4[15:6]	0x000

Table 33. Scrambler 8-bit Input (Register 0x573[5:4]='b10)

8-Bit Octet Number	Alternating Checkerboard	1/0 Word Toggle	Ramp	PN9	PN23	User Repeat	User Single
0	0x55	0x00	$(X) \% 2^8$	0x49	0xFF	UP1[15:9]	UP1[15:9]
1	0xAA	0xFF	$(X + 1) \% 2^8$	0x6F	0x5C	UP2[15:9]	UP2[15:9]
2	0x55	0x00	$(X + 2) \% 2^8$	0xC9	0x00	UP3[15:9]	UP3[15:9]
3	0xAA	0xFF	$(X + 3) \% 2^8$	0xA9	0x29	UP4[15:9]	UP4[15:9]
4	0x55	0x00	$(X + 4) \% 2^8$	0x98	0xB8	UP1[15:9]	0x00
5	0xAA	0xFF	$(X + 5) \% 2^8$	0x0C	0x0A	UP2[15:9]	0x00
6	0x55	0x00	$(X + 6) \% 2^8$	0x65	0x3D	UP3[15:9]	0x00
7	0xAA	0xFF	$(X + 7) \% 2^8$	0x1A	0x72	UP4[15:9]	0x00
8	0x55	0x00	$(X + 8) \% 2^8$	0x5F	0x9B	UP1[15:9]	0x00
9	0xAA	0xFF	$(X + 9) \% 2^8$	0xD1	0x26	UP2[15:9]	0x00
10	0x55	0x00	$(X + 10) \% 2^8$	0x63	0x43	UP3[15:9]	0x00
11	0xAA	0xFF	$(X + 11) \% 2^8$	0xAC	0xFF	UP4[15:9]	0x00

Data Link Layer Test Modes

The data link layer test modes are implemented in the [AD9690](#) as defined by section 5.3.3.8.2 in the JEDEC JESD204B Specification. These tests are shown in Register 0x574 Bits[2:0].

Test patterns inserted at this point are useful for verifying the functionality of the data link layer. When the data link layer test modes are enabled, disable SYNCINB± by writing 0xC0 to Register 0x572.

SERIAL PORT INTERFACE

The AD9690 SPI allows the user to configure the converter for specific functions or operations through a structured register space provided inside the ADC. The SPI gives the user added flexibility and customization, depending on the application. Addresses are accessed via the serial port and can be written to or read from via the port. Memory is organized into bytes that can be further divided into fields. These fields are documented in the Memory Map section. For detailed operational information, see the [Serial Control Interface Standard \(Rev. 1.0\)](#).

CONFIGURATION USING THE SPI

Three pins define the SPI of the AD9690 ADC: the SCLK pin, the SDIO pin, and the CSB pin (see Table 34). The SCLK (serial clock) pin is used to synchronize the read and write data presented from/to the ADC. The SDIO (serial data input/output) pin is a dual-purpose pin that allows data to be sent and read from the internal ADC memory map registers. The CSB (chip select bar) pin is an active low control that enables or disables the read and write cycles.

Table 34. Serial Port Interface Pins

Pin	Function
SCLK	Serial clock. The serial shift clock input, which is used to synchronize serial interface, reads, and writes.
SDIO	Serial data input/output. A dual-purpose pin that typically serves as an input or an output, depending on the instruction being sent and the relative position in the timing frame.
CSB	Chip select bar. An active low control that gates the read and write cycles.

The falling edge of CSB, in conjunction with the rising edge of SCLK, determines the start of the framing. An example of the serial timing and its definitions can be found in Figure 4 and Table 5.

Other modes involving CSB are available. The CSB can be held low indefinitely, which permanently enables the device; this is called streaming. The CSB can stall high between bytes to allow additional external timing. When CSB is tied high, SPI functions are placed in a high impedance mode. This mode turns on any SPI pin secondary functions.

All data is composed of 8-bit words. The first bit of each individual byte of serial data indicates whether a read or write command is issued, which allows the SDIO pin to change direction from an input to an output.

In addition to word length, the instruction phase determines whether the serial frame is a read or write operation, allowing the serial port to be used both to program the chip and to read the contents of the on-chip memory. If the instruction is a readback operation, performing a readback causes the SDIO pin to change direction from an input to an output at the appropriate point in the serial frame.

Data can be sent in MSB first mode or in LSB first mode. MSB first is the default on power-up and can be changed via the SPI port configuration register. For more information about this and other features, see the [Serial Control Interface Standard \(Rev. 1.0\)](#).

HARDWARE INTERFACE

The pins described in Table 34 comprise the physical interface between the user programming device and the serial port of the AD9690. The SCLK pin and the CSB pin function as inputs when using the SPI interface. The SDIO pin is bidirectional, functioning as an input during write phases and as an output during readback.

The SPI interface is flexible enough to be controlled by either FPGAs or microcontrollers. One method for SPI configuration is described in detail in the [AN-812 Application Note, Microcontroller-Based Serial Port Interface \(SPI\) Boot Circuit](#).

Do not activate the SPI port during periods when the full dynamic performance of the converter is required. Because the SCLK signal, the CSB signal, and the SDIO signal are typically asynchronous to the ADC clock, noise from these signals can degrade converter performance. If the on-board SPI bus is used for other devices, it may be necessary to provide buffers between this bus and the AD9690 to prevent these signals from transitioning at the converter inputs during critical sampling periods.

SPI ACCESSIBLE FEATURES

Table 35 provides a brief description of the general features that are accessible via the SPI. These features are described in detail in the [Serial Control Interface Standard \(Rev. 1.0\)](#). The AD9690 device-specific features are described in the Memory Map section.

Table 35. Features Accessible Using the SPI

Feature Name	Description
Mode	Allows the user to set either power-down mode or standby mode.
Clock	Allows the user to access the clock divider via the SPI.
DDC	Allows the user to set up decimation filters for different applications.
Test Input/Output	Allows the user to set test modes to have known data on output bits.
Output Mode	Allows the user to set up outputs.
SERDES Output Setup	Allows the user to vary SERDES settings such as swing and emphasis.

MEMORY MAP

READING THE MEMORY MAP REGISTER TABLE

Each row in the memory map register table has eight bit locations. The memory map is divided into four sections: the Analog Devices SPI registers (Register 0x000 to Register 0x00D), the analog input buffer control registers, the ADC function registers, the DDC function registers, and the digital outputs and test modes registers.

Table 36 (see the Memory Map Register Table section) documents the default hexadecimal value for each hexadecimal address shown. The column with the heading Bit 7 (MSB) is the start of the default hexadecimal value given. For example, Address 0x561, the output mode register, has a hexadecimal default value of 0x01, which means that Bit 0 = 1, and the remaining bits are 0s. This setting is the default output format value, which is twos complement. For more information on this function and others, see the Table 36.

Open and Reserved Locations

All address and bit locations that are not included in Table 36 are not currently supported for this device. Write unused bits of a valid address location with 0s unless the default value is set otherwise.

Writing to these locations is required only when part of an address location is unassigned (for example, Address 0x561). If the entire address location is open (for example, Address 0x13), do not write to this address location.

Default Values

After the AD9690 is reset, critical registers are loaded with default values. The default values for the registers are given in the memory map register table, Table 36.

Logic Levels

An explanation of logic level terminology follows:

- “Bit is set” is synonymous with “bit is set to Logic 1” or “writing Logic 1 for the bit.”
- “Clear a bit” is synonymous with “bit is set to Logic 0” or “writing Logic 0 for the bit.”
- X denotes a don't care bit.

SPI Soft Reset

After issuing a soft reset by programming 0x81 to Register 0x000, the AD9690 requires 5 ms to recover. When programming the AD9690 for application setup, ensure that an adequate delay is programmed into the firmware after asserting the soft reset and before starting the device setup.

MEMORY MAP REGISTER TABLE

All address locations that are not included in Table 36 are not currently supported for this device and should not be written.

Table 36. Memory Map Registers

Reg Addr (Hex)	Register Name	Bit 7 (MSB)	Bit 6	Bit 5	Bit 4	Bit 3	Bit 2	Bit 1	Bit 0 (LSB)	Default	Notes	
Analog Devices SPI Registers												
0x000	INTERFACE_CONFIG_A	Soft reset (self clearing)	LSB first 0 = MSB 1 = LSB	Address ascension	0	0	Address ascension	LSB first 0 = MSB 1 = LSB	Soft reset (self clearing)	0x00		
0x001	INTERFACE_CONFIG_B	Single instruction	0	0	0	0	0	Datapath soft reset (self clearing)	0	0x00		
0x002	DEVICE_CONFIG	0	0	0	0	0	0	00 = normal operation 10 = standby 11 = power-down		0x00		
0x003	CHIP_TYPE							011 = high speed ADC		0x03	Read only	
0x004	CHIP_ID (low byte)	1	1	0	0	0	1	0	1	0xD6	Read only	
0x005	CHIP_ID (high byte)	0	0	0	0	0	0	0	0	0x00	Read only	
0x006	CHIP_GRADE	1010 = 1000 MSPS 0101 = 500 MSPS				X	X	X	X		Read only	
0x008	Device index	0	0	0	0	0	0	0	1	0x01	Reserved	
0x00A	Scratch pad	0	0	0	0	0	0	0	0	0x00		
0x00B	SPI revision	0	0	0	0	0	0	0	1	0x01		
0x00C	Vendor ID (low byte)	0	1	0	1	0	1	1	0	0x56	Read only	
0x00D	Vendor ID (high byte)	0	0	0	0	0	1	0	0	0x04	Read only	
Analog Input Buffer Control Registers												
0x015	Analog input	0	0	0	0	0	0	0	Input disable 0 = normal operation 1 = input disabled	0x00		
0x016	Input termination	Analog input differential termination 0000 = 400 Ω (default) 0001 = 200 Ω 0010 = 100 Ω 0110 = 50 Ω				1110 = AD9690-1000 1100 = AD9690-500						
0x934	Input capacitance	0	0	0	0x1F = 3 pF to GND (default) 0x00 = 1.5 pF to GND					0x1F		
0x018	Buffer Control 1	0000 = 1.0× buffer current 0001 = 1.5× buffer current 0010 = 2.0× buffer current (default for AD9690-500) 0011 = 2.5× buffer current 0100 = 3.0× buffer current (default for AD9690-1000) 0101 = 3.5× buffer current ... 1111 = 8.5× buffer current				0100 = AD9690-1000 0010 = AD9690-500					0x44 for AD9690-1000; 0x22 for AD9690-500	
0x019	Buffer Control 2	0100 = setting 1 0101 = setting 2 (default for AD9690-1000) 0110 = setting 3 (default for AD9690-500) 0111 = setting 4				0	0	0	0		0x50 for AD9690-1000; 0x60 for AD9690-500	

Reg Addr (Hex)	Register Name	Bit 7 (MSB)	Bit 6	Bit 5	Bit 4	Bit 3	Bit 2	Bit 1	Bit 0 (LSB)	Default	Notes
0x01A	Buffer Control 3	0	0	0	0	1000 = setting 1 1001 = setting 2 (default for AD9690-1000) 1010 = setting 3 (default for AD9690-500)			0x09 for AD9690-1000; 0x0A for AD9690-500		
0x11A	Buffer Control 4	0	0	High frequency setting 0 = OFF (default) 1 = ON	0	0	0	0	0		
0x935	Buffer Control 5	0	0	0	0	0	Low Frequency Operation 0 = off 1 = on (default)	0	0		
0x025	Input full-scale range	0	0	0	0	Full-scale adjust 0000 = 1.94 V 1000 = 1.46 V 1001 = 1.58 V 1010 = 1.70 V (default for AD9690-1000) 1011 = 1.82 V 1100 = 2.06 V (default for AD9690-500)			0x0A for AD9690-1000; 0x0C for AD9690-500	V p-p differential; use in conjunction with Reg. 0x030	
0x030	Input full-scale control	0	0	0	Full-scale control See Table 10 for recommended settings for different frequency bands; default values: AD9690-1000 = 110 AD9690-500 = 001 AD9690-500 = 110 (for <1.82 V)			0	0		Used in conjunction with Reg. 0x025
ADC Function Registers											
0x024	V _{1P0} control	0	0	0	0	0	0	0	1.0 V reference select 0 = internal 1 = external	0x00	
0x028	Temperature diode	0	0	0	0	0	0	0	Diode selection 0 = no diode selected 1 = temperature diode selected	0x00	Used in conjunction with Reg. 0x040
0x03F	PDWN/STBY pin control	0 = PDWN/STBY enabled 1 = disabled	0	0	0	0	0	0	0	0x00	Used in conjunction with Reg. 0x040
0x040	Chip pin control	PDWN/STBY function 00 = power down 01 = standby 10 = disabled		111 = Reserved			Fast Detect (FD) 000 = Fast Detect output 001 = JESD204B LMFC output 010 = JESD204B internal SYNC~ output 011 = temperature diode 111 = disabled			0x3F	
0x10B	Clock divider	0	0	0	0	0	000 = divide by -1 001 = divide by 2 011 = divide by 4 111 = divide by 8			0x00	

Reg Addr (Hex)	Register Name	Bit 7 (MSB)	Bit 6	Bit 5	Bit 4	Bit 3	Bit 2	Bit 1	Bit 0 (LSB)	Default	Notes
0x10C	Clock divider phase	0	0	0	0	Independently controls ADC clock divider phase offset 0000 = 0 input clock cycles delayed 0001 = ½ input clock cycles delayed 0010 = 1 input clock cycles delayed 0011 = 1½ input clock cycles delayed 0100 = 2 input clock cycles delayed 0101 = 2½ input clock cycles delayed ... 1111 = 7½ input clock cycles delayed			0x00		
0x10D	Clock divider and SYSREF control	Clock divider auto phase adjust 0 = disabled 1 = enabled	0	0	0	Clock divider negative skew window 00 = no negative skew 01 = 1 device clock of negative skew 10 = 2 device clocks of negative skew 11 = 3 device clocks of negative skew	Clock divider positive skew window 00 = no positive skew 01 = 1 device clock of positive skew 10 = 2 device clocks of positive skew 11 = 3 device clocks of positive skew	0x00	Clock divider must be >1		
0x117	Clock delay control	0	0	0	0	0	0	0	Clock fine delay adjust enable 0 = disabled 1 = enabled	0x00	Enabling the clock fine delay adjust causes a datapath reset
0x118	Clock fine delay	Clock fine delay adjust[7:0], twos complement coded control to adjust the fine sample clock skew in ~1.7 ps steps ≤ -88 = -151.7 ps skew -87 = -150 ps skew ... 0 = 0 ps skew ... ≥ +87 = +150 ps skew							0x00	Used in conjunction with Reg. 0x0117	
0x11C	Clock status	0	0	0	0	0	0	0	0 = no input clock detected 1 = input clock detected	Read only	
0x120	SYSREF± Control 1	0	SYSREF± flag reset 0 = normal operation 1 = flags held in reset	0	SYSREF± transition select 0 = low to high 1 = high to low	CLK± edge select 0 = rising 1 = falling	SYSREF± mode select 00 = disabled 01 = continuous 10 = N shot	0	0x00		
0x121	SYSREF± Control 2	0	0	0	0	SYSREF N-shot ignore counter select 0000 = next SYSREF± only 0001 = ignore the first SYSREF± transitions 0010 = ignore the first two SYSREF± transitions ... 1111 = ignore the first 16 SYSREF± transitions			0x00	Mode select (Reg 0x120, Bits [2:1]) must be N-shot	
0x123	SYSREF± timestamp delay control	SYSREF± timestamp delay, Bits[6:0] 0x00 = no delay 0x01 = 1 clock delay ... 0x7F = 127 clocks delay							0x00	Ignored when Reg. 0x01FF = 0x00	
0x128	SYSREF± Status 1	SYSREF± hold status, Register 0x128[7:4], refer to Table 28				SYSREF± setup status, Register 0x128[3:0], refer to Table 28				Read only	

Reg Addr (Hex)	Register Name	Bit 7 (MSB)	Bit 6	Bit 5	Bit 4	Bit 3	Bit 2	Bit 1	Bit 0 (LSB)	Default	Notes
0x129	SYSREF± and clock divider status	0	0	0	0	Clock divider phase when SYSREF± was captured 0000 = in-phase 0001 = SYSREF± is ½ cycle delayed from clock 0010 = SYSREF± is 1 cycle delayed from clock 0011 = 1½ input clock cycles delayed 0100 = 2 input clock cycles delayed 0101 = 2½ input clock cycles delayed ... 1111 = 7½ input clock cycles delayed				Read only	
0x12A	SYSREF± counter	SYSREF counter, Bits[7:0] increments when a SYSREF± is captured								Read only	
0x1FF	Chip sync mode							Synchronization mode 00 = normal 01 = timestamp		0x00	
0x200	Chip application mode	0	0	Chip Q ignore 0 = normal (I/Q) 1 = ignore (I - only)	0	0	0	Chip operating mode 00 = full bandwidth mode 01 = DDC 0 on 10 = DDC 0 and DDC 1 on		0x00	
0x201	Chip decimation ratio	0	0	0	0	0	Chip decimation ratio select 000 = full sample rate (decimate = 1) 001 = decimate by 2 010 = decimate by 4 011 = decimate by 8 100 = decimate by 16			0x00	
0x228	Customer offset	Offset adjust in LSBs from +127 to -128 (twos complement format)								0x00	
0x245	Fast detect (FD) control	0	0	0	0	Force FD pin; 0 = normal function; 1 = force to value	Force value of FD pin if force pins is true, this value is output on FD pin	0	Enable fast detect output	0x00	
0x247	FD upper threshold LSB	Fast detect upper threshold, Bits[7:0]								0x00	
0x248	FD upper threshold MSB	0	0	0	Fast detect upper threshold, Bits[12:8]					0x00	
0x249	FD lower threshold LSB	Fast detect lower threshold, Bits[7:0]								0x00	
0x24A	FD lower threshold MSB	0	0	0	Fast detect lower threshold, Bits[12:8]					0x00	
0x24B	FD dwell time LSB	Fast detect dwell time, Bits[7:0]								0x00	
0x24C	FD dwell time MSB	Fast detect dwell time, Bits[15:8]								0x00	
0x26F	Signal monitor synchronization control	0	0	0	0	0	0	Synchronization mode 00 = disabled 01 = continuous 11 = one shot		0x00	Refer to the Signal Monitor section
0x270	Signal monitor control	0	0	0	0	0	0	Peak detector 0 = disabled 1 = enabled	0	0x00	

Reg Addr (Hex)	Register Name	Bit 7 (MSB)	Bit 6	Bit 5	Bit 4	Bit 3	Bit 2	Bit 1	Bit 0 (LSB)	Default	Notes
0x271	Signal Monitor Period Register 0	Signal monitor period, Bits[7:0]								0x80	In decimated output clock cycles
0x272	Signal Monitor Period Register 1	Signal monitor period, Bits[15:8]								0x00	In decimated output clock cycles
0x273	Signal Monitor Period Register 2	Signal monitor period, Bits[23:16]								0x00	In decimated output clock cycles
0x274	Signal monitor result control	0	0	0	Result update 1 = update results (self clear)	0	0	0	Result selection 0 = reserved 1 = peak detector	0x01	
0x275	Signal Monitor Result Register 0	Signal monitor result, Bits[7:0] When Register 0x0274[0] = 1, result bits [19:7] = peak detector absolute value [12:0]; result bits [6:0] = 0								Read only	Updated based on Reg. 0x274[4]
0x276	Signal Monitor Result Register 1	Signal monitor result, Bits[15:8]								Read only	Updated based on Reg. 0x274[4]
0x277	Signal Monitor Result Register 1	0	0	0	0	Signal monitor result, Bits[19:16]			Read only	Updated based on Reg. 0x274[4]	
0x278	Signal monitor period counter result	Period count result, Bits[7:0]								Read only	Updated based on Reg. 0x274[4]
0x279	Signal monitor SPORT over JESD204B control	0	0	0	0	0	0	00 = reserved 11 = enable		0x00	
0x27A	SPORT over JESD204B input selection	0	0	0	0	0	0	Peak detector 0 = disabled 1 = enabled	0	0x00	
DDC Function Registers (See the Digital Downconverter (DDC) Section)											
0x300	DDC synch control	0	0	0	DDC NCO soft reset 0 = normal operation 1 = reset	0	0	Synchronization mode (triggered by SYSREF±) 00 = disabled 01 = continuous 11 = 1-shot			

Reg Addr (Hex)	Register Name	Bit 7 (MSB)	Bit 6	Bit 5	Bit 4	Bit 3	Bit 2	Bit 1	Bit 0 (LSB)	Default	Notes
0x310	DDC 0 control	Mixer select 0 = real mixer 1 = complex mixer	Gain select 0 = 0 dB gain 1 = 6 dB gain	IF (intermediate frequency) mode 00 = variable IF mode (mixers and NCO enabled) 01 = 0 Hz IF mode (mixer bypassed, NCO disabled) 10 = $f_{ADC}/4$ Hz IF mode ($f_{ADC}/4$ down-mixing mode) 11 = test mode (mixer inputs forced to +FS, NCO enabled)		Complex to real enable 0 = disabled 1 = enabled	0	Decimation rate select (complex—real disabled) 11 = decimate by 2 00 = decimate by 4 01 = decimate by 8 10 = decimate by 16 (complex—real enabled) 11 = decimate by 1 00 = decimate by 2 01 = decimate by 4 10 = decimate by 8		0x00	
0x311	DDC 0 input selection	0	0	0	0	0	0	0	0	0x00	Refer to the DDC section
0x314	DDC 0 frequency LSB	DDC 0 NCO frequency value, Bits[7:0] twos complement								0x00	
0x315	DDC 0 frequency MSB	X	X	X	X	DDC 0 NCO frequency value, Bits[11:8] twos complement				0x00	
0x320	DDC 0 phase LSB	DDC 0 NCO phase value, Bits[7:0] twos complement								0x00	
0x321	DDC 0 phase MSB	X	X	X	X	DDC 0 NCO phase value, Bits[11:8] twos complement				0x00	
0x327	DDC 0 output test mode selection	0	0	0	0	0	0	0	I output test mode enable 0 = disabled 1 = enabled	0x00	Refer to the DDC section
0x330	DDC 1 control	Mixer select 0 = real mixer 1 = complex mixer	Gain select 0 = 0 dB gain 1 = 6 dB gain	IF (intermediate frequency) mode 00 = variable IF mode (mixers and NCO enabled) 01 = 0 Hz IF mode (mixer bypassed, NCO disabled) 10 = $f_{ADC}/4$ Hz IF mode ($f_{ADC}/4$ downmixing mode) 11 = test mode (mixer inputs forced to +FS, NCO enabled)		Complex to real enable 0 = disabled 1 = enabled	0	Decimation rate select (complex—real disabled) 11 = decimate by 2 00 = decimate by 4 01 = decimate by 8 10 = decimate by 16 (complex—real enabled) 11 = decimate by 1 00 = decimate by 2 01 = decimate by 4 10 = decimate by 8		0x00	
0x331	DDC 1 input selection	0	0	0	0	0	0	0	0	0x00	Refer to the DDC section
0x334	DDC 1 frequency LSB	DDC 1 NCO frequency value, Bits[7:0] twos complement								0x00	
0x335	DDC 1 frequency MSB	X	X	X	X	DDC 1 NCO frequency value, Bits[11:8] twos complement				0x00	
0x340	DDC 1 phase LSB	DDC 1 NCO phase value, Bits[7:0] twos complement								0x00	
0x341	DDC 1 phase MSB	X	X	X	X	DDC 1 NCO phase value, Bits[11:8] twos complement				0x00	
0x347	DDC 1 output test mode selection	0	0	0	0	0	0	0	I output test mode enable 0 = disabled 1 = enabled	0x00	Refer to the DDC section

Reg Addr (Hex)	Register Name	Bit 7 (MSB)	Bit 6	Bit 5	Bit 4	Bit 3	Bit 2	Bit 1	Bit 0 (LSB)	Default	Notes
Digital Outputs and Test Modes											
0x550	ADC test modes	User pattern selection 0 = continuous repeat 1 = single pattern	0	Reset PN long gen 0 = long PN enable 1 = long PN reset	Reset PN short gen 0 = short PN enable 1 = short PN reset	Test mode selection 0000 = off, normal operation 0001 = midscale short 0010 = positive full-scale 0011 = negative full-scale 0100 = alternating checker board 0101 = PN sequence, long 0110 = PN sequence, short 0111 = 1/0 word toggle 1000 = the user pattern test mode (used with Register 0x0550, Bit 7 and user pattern 1, 2, 3, 4 registers) 1111 = ramp output				0x00	
0x551	User Pattern 1 LSB	0	0	0	0	0	0	0	0	0x00	Used with Reg. 0x550 and Reg. 0x573
0x552	User Pattern 1 MSB	0	0	0	0	0	0	0	0	0x00	Used with Reg. 0x550 and Reg. 0x573
0x553	User Pattern 2 LSB	0	0	0	0	0	0	0	0	0x00	Used with Reg. 0x550 and Reg. 0x573
0x554	User Pattern 2 MSB	0	0	0	0	0	0	0	0	0x00	Used with Reg. 0x550 and Reg. 0x573
0x555	User Pattern 3 LSB	0	0	0	0	0	0	0	0	0x00	Used with Reg. 0x550 and Reg. 0x573
0x556	User Pattern 3 MSB	0	0	0	0	0	0	0	0	0x00	Used with Reg. 0x550 and Reg. 0x573
0x557	User Pattern 4 LSB	0	0	0	0	0	0	0	0	0x00	Used with Reg. 0x550 and Reg. 0x573
0x558	User Pattern 4 MSB	0	0	0	0	0	0	0	0	0x00	Used with Reg. 0x550 and Reg. 0x573
0x559	Output Mode Control 1	0	Converter control Bit 1 selection 000 = tie low (1'b0) 001 = overrange bit 011 = fast detect (FD) bit 101 = SYSREF± Only used when CS (Register 0x58F) = 2 or 3			0	Converter control Bit 0 selection 000 = tie low (1'b0) 001 = overrange bit 011 = fast detect (FD) bit 101 = SYSREF± Only used when CS (Register 0x58F) = 3			0x00	
0x55A	Output Mode Control 2	0	0	0	0	0	Converter control Bit 2 selection 000 = tie low (1'b0) 001 = overrange bit 011 = fast detect (FD) bit 101 = SYSREF Used when CS (Register 0x58F) = 1, 2, or 3			0x00	

Reg Addr (Hex)	Register Name	Bit 7 (MSB)	Bit 6	Bit 5	Bit 4	Bit 3	Bit 2	Bit 1	Bit 0 (LSB)	Default	Notes
0x561	Output mode	0	0	0	0	0	Sample invert 0 = normal 1 = sample invert	Data format select 00 = offset binary 01 = twos complement		0x01	
0x562	Output overrange (OR) clear	0	0	0	0	Virtual Converter 3 OR 0 = OR bit enabled 1 = OR bit cleared	Virtual Converter 2 OR 0 = OR bit enabled 1 = OR bit cleared	Virtual Converter 1 OR 0 = OR bit enabled 1 = OR bit cleared	Virtual Converter 0 OR 0 = OR bit enabled 1 = OR bit cleared	0x00	
0x563	Output OR status	0	0	0	0	Virtual Converter 3 OR 0 = no OR 1 = OR occurred	Virtual Converter 2 OR 0 = no OR 1 = OR occurred	Virtual Converter 1 OR 0 = no OR 1 = OR occurred	Virtual Converter 0 OR 0 = no OR 1 = OR occurred	0x00	Read only
0x56E	JESD204B lane rate control	0	0	0	0 = serial lane rate ≥ 6.25 Gbps and ≤ 12.5 Gbps 1 = serial lane rate must be ≥ 3.125 Gbps and ≤ 6.25 Gbps	0	0	0	0	0x10	
0x56F	JESD204B PLL lock status	PLL lock 0 = not locked 1 = locked	0	0	0	0	0	0	0	0x00	Read only
0x570	JESD204B quick configuration	JESD204B quick configuration L = number of lanes = $2^{\text{Register 0x570, Bits[7:6]}}$ M = number of converters = $2^{\text{Register 0x570, Bits[5:3]}}$ F = number of octets/frame = $2^{\text{Register 0x570, Bits[2:0]}}$								0x80 for AD9690-1000; 0x40 for AD9690-500	Refer to Table 26 and Table 27
0x571	JESD204B Link Mode Control 1	Standby mode 0 = all converter outputs 0 1 = CGS (/K28.5/)	Tail bit (t) PN 0 = disable 1 = enable T = N' - N - CS	Long transport layer test 0 = disable 1 = enable	Lane synchronization 0 = disable FACI uses /K28.7/ 1 = enable FACI uses /K28.3/ and /K28.7/	ILAS sequence mode 00 = ILAS disabled 01 = ILAS enabled 11 = ILAS always on test mode	FACI 0 = enabled 1 = disabled	Link control 0 = active 1 = power down	0x14		
0x572	JESD204B Link Mode Control 2	SYNCINB± pin control 00 = normal 10 = ignore SYNCINB± (force CGS) 11 = ignore SYNCINB± (force ILAS/user data)		SYNCINB± pin invert 0 = active low 1 = active high	SYNCINB± pin type 0 = differential 1 = CMOS	0	8-bit/10-bit bypass 0 = normal 1 = bypass	8-/10-bit bit invert 0 = normal 1 = invert the abcd efghij symbols	0	0x00	
0x573	JESD204B Link Mode Control 3	CHKSUM mode 00 = sum of all 8-bit link config registers 01 = sum of individual link config fields 10 = checksum set to zero		Test injection point 00 = N' sample input 01 = 10-bit data at 8-bit/10-bit output (for PHY testing) 10 = 8-bit data at scrambler input		JESD204B test mode patterns 0000 = normal operation (test mode disabled) 0001 = alternating checker board 0010 = 1/0 word toggle 0011 = 31-bit PN sequence— $X^{31} + X^{28} + 1$ 0100 = 23-bit PN sequence— $X^{23} + X^{18} + 1$ 0101 = 15-bit PN sequence— $X^{15} + X^{14} + 1$ 0110 = 9-bit PN sequence— $X^9 + X^5 + 1$ 0111 = 7-bit PN sequence— $X^7 + X^6 + 1$ 1000 = ramp output 1110 = continuous/repeat user test 1111 = single user test				0x00	

Reg Addr (Hex)	Register Name	Bit 7 (MSB)	Bit 6	Bit 5	Bit 4	Bit 3	Bit 2	Bit 1	Bit 0 (LSB)	Default	Notes
0x574	JESD204B Link Mode Control 4	ILAS delay 0000 = transmit ILAS on first LMFC after SYNCINB± deasserted 0001 = transmit ILAS on second LMFC after SYNCINB± deasserted ... 1111 = transmit ILAS on 16 th LMFC after SYNCINB± deasserted				0	Link layer test mode 000 = normal operation (link layer test mode disabled) 001 = continuous sequence of /D21.5/ characters 100 = modified RPAT test sequence 101 = JSPAT test sequence 110 = JTSPAT test sequence			0x00	
0x578	JESD204B LMFC offset	0	0	0	LMFC phase offset value[4:0]					0x00	
0x580	JESD204B DID config	JESD204B Tx DID value[7:0]								0x00	
0x581	JESD204B BID config	0	0	0	0	JESD204B Tx BID value, Bits[3:0]			0x00		
0x583	JESD204B LID Config 1	0	0	0	Lane 0 LID value, Bits[4:0]				0x00		
0x584	JESD204B LID Config 2	0	0	0	Lane 1 LID value, Bits[4:0]				0x01		
0x585	JESD204B LID Config 3	0	0	0	Lane 2 LID value, Bits[4:0]				0x01		
0x586	JESD204B LID Config 4	0	0	0	Lane 3 LID value, Bits[4:0]				0x03		
0x58B	JESD204B parameters SCR/L	JESD204B scrambling (SCR) 0 = disabled 1 = enabled	0	0	0	0	0	JESD204B lanes (L) 00 = 1 lane 01 = 2 lanes 11 = 4 lanes Read only, see Register 0x570		0x8X	
0x58C	JESD204B F config	Number of octets per frame, F = Register 0x58C[7:0] + 1								0x88	Read only, see Reg. 0x570
0x58D	JESD204B K config	0	0	0	Number of frames per multiframe, K = Register 0x58D[4:0] + 1. Only values where (F × K) mod 4 = 0 are supported				0x1F	See Reg. 0x570	
0x58E	JESD204B M config	Number of converters per link[7:0] 0x00 = link connected to one virtual converter (M = 1) 0x01 = link connected to two virtual converters (M = 2) 0x03 = link connected to four virtual converters (M = 4)									Read only
0x58F	JESD204B CS/N config	Number of control bits (CS) per sample 00 = no control bits (CS = 0) 01 = 1 control bit (CS = 1); Control Bit 2 only 10 = 2 control bits (CS = 2); Control Bit 2 and 1 only 11 = 3 control bits (CS = 3); all control bits (2, 1, 0)		0	ADC converter resolution (N) 0x0D = 14-bit resolution 0x0F = 16-bit resolution						
0x590	JESD204B N' config	0	0	Subclass support (Subclass V) 0 = Subclass 0 (no deterministic latency) 1 = Subclass 1		ADC number of bits per sample (N') 0x7 = 8 bits 0xF = 16 bits				0x2F	
0x591	JESD204B S config	0	0	1	Samples per converter frame cycle (S) S value = Register 0x591[4:0] + 1						Read only

Reg Addr (Hex)	Register Name	Bit 7 (MSB)	Bit 6	Bit 5	Bit 4	Bit 3	Bit 2	Bit 1	Bit 0 (LSB)	Default	Notes	
0x592	JESD204B HD and CF config	HD value 0 = disabled 1 = enabled	0	0	Control words per frame clock cycle per link (CF) CF value = Register 0x592, Bits[4:0]					0x80	Read only	
0x5A0	JESD204B CHKSUM 0	CHKSUM value for SERDOUT0±, Bits[7:0]								0x81	Read only	
0x5A1	JESD204B CHKSUM 1	CHKSUM value for SERDOUT1±, Bits[7:0]								0x82	Read only	
0x5A2	JESD204B CHKSUM 2	CHKSUM value for SERDOUT2±, Bits[7:0]								0x82	Read only	
0x5A3	JESD204B CHKSUM 3	CHKSUM value for SERDOUT3±, Bits[7:0]								0x84	Read only	
0x5B0	JESD204B lane power-down	1	SERD-OUT3± 0 = on 1 = off	1	SERD-OUT2± 0 = on 1 = off	1	SERD-OUT1± 0 = on 1 = off	1	SERD-OUT0± 0 = on 1 = off	0xAA		
0x5B2	JESD204B lane SERDOUT0± assign	X	X	X	X	0	SERDOUT0± lane assignment 000 = Logical Lane 0 001 = Logical Lane 1 010 = Logical Lane 2 011 = Logical Lane 3			0x00		
0x5B3	JESD204B lane SERDOUT1± assign	X	X	X	X	0	SERDOUT1± lane assignment 000 = Logical Lane 0 001 = Logical Lane 1 010 = Logical Lane 2 011 = Logical Lane 3			0x11		
0x5B5	JESD204B lane SERDOUT2± assign	X	X	X	X	0	SERDOUT2± lane assignment 000 = Logical Lane 0 001 = Logical Lane 1 010 = Logical Lane 2 011 = Logical Lane 3			0x22		
0x5B6	JESD204B lane SERDOUT3± assign	X	X	X	X	0	SERDOUT3± lane assignment 000 = Logical Lane 0 001 = Logical Lane 1 010 = Logical Lane 2 011 = Logical Lane 3			0x33		
0x5BF	JESD serializer drive adjust	0	0	0	0	Swing voltage 0000 = 237.5 mV 0001 = 250 mV 0010 = 262.5 mV 0011 = 275 mV 0100 = 287.5 mV 0101 = 300 mV 0110 = 312.5 mV 0111 = 325 mV 1000 = 337.5 mV 1001 = 350 mV 1010 = 362.5 mV 1011 = 375 mV 1100 = 387.5 mV 1101 = 400 mV 1110 = 412.5 mV 1111 = 425 mV						
0x5C1	De-emphasis select	0	SERD-OUT3± 0 = disable 1 = enable	0	SERD-OUT2± 0 = disable 1 = enable	0	SERDOUT1± 0 = disable 1 = enable	0	SERDOUT0± 0 = disable 1 = enable	0x00		

Reg Addr (Hex)	Register Name	Bit 7 (MSB)	Bit 6	Bit 5	Bit 4	Bit 3	Bit 2	Bit 1	Bit 0 (LSB)	Default	Notes
0x5C2	De-emphasis setting for SERDOUT0±	0	0	0	0	SERDOUT0± de-emphasis settings: 0000 = 0 dB, 0001 = 0.3 dB, 0010 = 0.8 dB, 0011 = 1.4 dB, 0100 = 2.2 dB, 0101 = 3.0 dB, 0110 = 4.0 dB, 0111 = 5.0 dB				0x00	
0x5C3	De-emphasis setting for SERDOUT1±	0	0	0	0	SERDOUT1± de-emphasis settings: 0000 = 0 dB, 0001 = 0.3 dB, 0010 = 0.8 dB, 0011 = 1.4 dB, 0100 = 2.2 dB, 0101 = 3.0 dB, 0110 = 4.0 dB, 0111 = 5.0 dB				0x00	
0x5C4	De-emphasis setting for SERDOUT2±	0	0	0	0	SERDOUT2± de-emphasis settings: 0000 = 0 dB, 0001 = 0.3 dB, 0010 = 0.8 dB, 0011 = 1.4 dB, 0100 = 2.2 dB, 0101 = 3.0 dB, 0110 = 4.0 dB, 0111 = 5.0 dB				0x00	
0x5C5	De-emphasis setting for SERDOUT3±	0	0	0	0	SERDOUT3± de-emphasis settings: 0000 = 0 dB, 0001 = 0.3 dB, 0010 = 0.8 dB, 0011 = 1.4 dB, 0100 = 2.2 dB, 0101 = 3.0 dB, 0110 = 4.0 dB, 0111 = 5.0 dB				0x00	

APPLICATIONS INFORMATION

POWER SUPPLY RECOMMENDATIONS

The [AD9690](#) must be powered by the following seven supplies: AVDD1 = 1.25 V, AVDD2 = 2.5 V, AVDD3 = 3.3 V, AVDD1_SR = 1.25 V, DVDD = 1.25 V, DRVDD = 1.25 V, and SPIVDD = 1.80 V. For applications requiring an optimal high power efficiency and low noise performance, it is recommended that the [ADP2164](#) and [ADP2370](#) switching regulators be used to convert the 3.3 V, 5.0 V, or 12 V input rails to an intermediate rail (1.8 V and 3.8 V). These intermediate rails are then postregulated by very low noise, low dropout (LDO) regulators ([ADP1741](#), [ADM7172](#), and [ADP125](#)). Figure 114 shows the recommended power supply scheme for [AD9690](#).

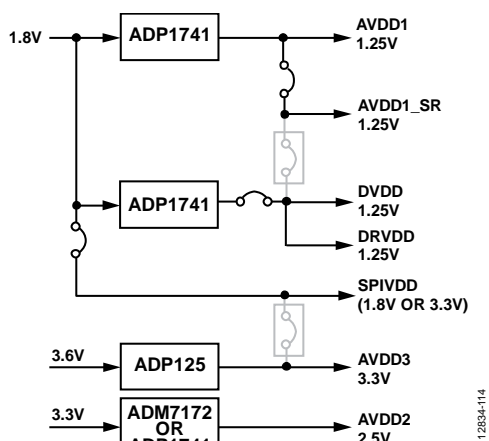

Figure 114. High Efficiency, Low Noise Power Solution for the [AD9690](#)

It is not necessary to split all of these power domains in all cases. The recommended solution shown in Figure 114 provides the lowest noise, highest efficiency power delivery system for the [AD9690](#). If only one 1.25 V supply is available, route to AVDD1 first and then tap it off and isolate it with a ferrite bead or a filter choke, preceded by decoupling capacitors for AVDD1_SR, DVDD, and DRVDD, in that order. This is shown as the optional path in Figure 114. The user can employ several different decoupling capacitors to cover both high and low frequencies. These capacitors must be located close to the point of entry at the PCB level and close to the devices, with minimal trace lengths.

EXPOSED PAD THERMAL HEAT SLUG RECOMMENDATIONS

The exposed pad on the underside of the ADC must be connected to AGND to achieve the best electrical and thermal performance of the [AD9690](#). Connect an exposed continuous copper plane on the PCB to the [AD9690](#) exposed pad, Pin 0.

The copper plane must have several vias to achieve the lowest possible resistive thermal path for heat dissipation to flow through the bottom of the PCB. These vias must be solder filled or plugged. The number of vias and the fill determine the resulting θ_{JA} measured on the board, as shown in Table 7.

To maximize the coverage and adhesion between the ADC and PCB, partition the continuous copper plane by overlaying a silkscreen on the PCB into several uniform sections. This provides several tie points between the ADC and PCB during the reflow process, whereas using one continuous plane with no partitions only guarantees one tie point. See Figure 115 for a PCB layout example. For detailed information on packaging and the PCB layout of chip scale packages, see the [AN-772 Application Note, A Design and Manufacturing Guide for the Lead Frame Chip Scale Package \(LFCSP\)](#).

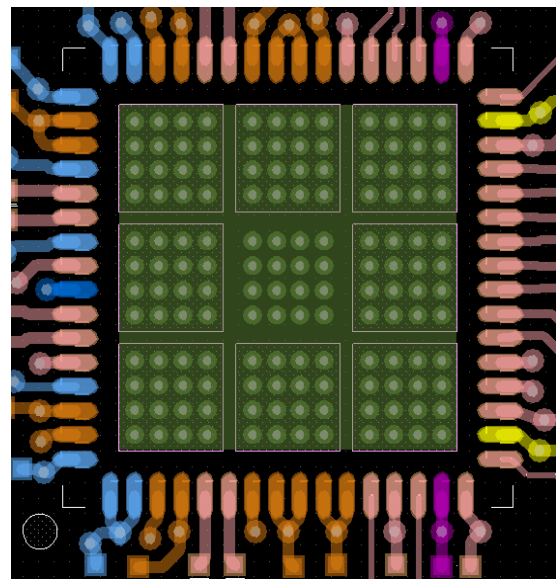

Figure 115. Recommended PCB Layout of Exposed Pad for the [AD9690](#)

AVDD1_SR (PIN 57) AND AGND (PIN 56 AND PIN 60)

AVDD1_SR (Pin 57) and AGND (Pin 56 and Pin 60) can be used to provide a separate power supply node to the SYSREF± circuits of [AD9690](#). If running in Subclass 1, the [AD9690](#) can support periodic one-shot or gapped signals. To minimize the coupling of this supply into the AVDD1 supply node, adequate supply bypassing is needed.

OUTLINE DIMENSIONS

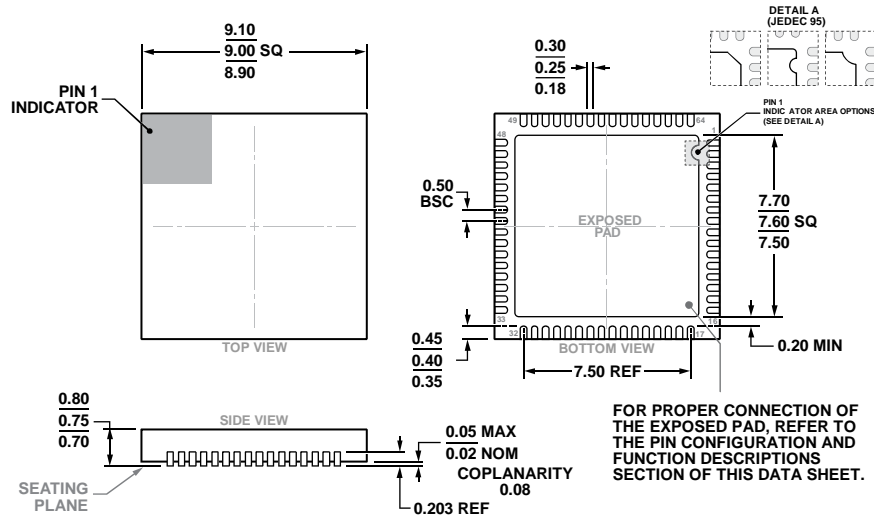

Figure 116. 64-Lead Lead Frame Chip Scale Package [LFCS]
9 mm × 9 mm Body and 0.75 mm Package Height
(CP-64-15)
Dimensions shown in millimeters

ORDERING GUIDE

Model ¹	Temperature Range	Package Description	Package Option
AD9690BCPZ-1000	-40°C to +85°C	64-Lead Lead Frame Chip Scale Package [LFCS]	CP-64-15
AD9690BCPZ-500	-40°C to +85°C	64-Lead Lead Frame Chip Scale Package [LFCS]	CP-64-15
AD9690BCPZRL7-1000	-40°C to +85°C	64-Lead Lead Frame Chip Scale Package [LFCS]	CP-64-15
AD9690BCPZRL7-500	-40°C to +85°C	64-Lead Lead Frame Chip Scale Package [LFCS]	CP-64-15

¹ Z = RoHS Compliant Part.



Компания «ЭлектроПласт» предлагает заключение долгосрочных отношений при поставках импортных электронных компонентов на взаимовыгодных условиях!

Наши преимущества:

- Оперативные поставки широкого спектра электронных компонентов отечественного и импортного производства напрямую от производителей и с крупнейших мировых складов;
- Поставка более 17-ти миллионов наименований электронных компонентов;
- Поставка сложных, дефицитных, либо снятых с производства позиций;
- Оперативные сроки поставки под заказ (от 5 рабочих дней);
- Экспресс доставка в любую точку России;
- Техническая поддержка проекта, помощь в подборе аналогов, поставка прототипов;
- Система менеджмента качества сертифицирована по Международному стандарту ISO 9001;
- Лицензия ФСБ на осуществление работ с использованием сведений, составляющих государственную тайну;
- Поставка специализированных компонентов (Xilinx, Altera, Analog Devices, Intersil, Interpoint, Microsemi, Aeroflex, Peregrine, Syfer, Eurofarad, Texas Instrument, Miteq, Cobham, E2V, MA-COM, Hittite, Mini-Circuits, General Dynamics и др.);

Помимо этого, одним из направлений компании «ЭлектроПласт» является направление «Источники питания». Мы предлагаем Вам помощь Конструкторского отдела:

- Подбор оптимального решения, техническое обоснование при выборе компонента;
- Подбор аналогов;
- Консультации по применению компонента;
- Поставка образцов и прототипов;
- Техническая поддержка проекта;
- Защита от снятия компонента с производства.



Как с нами связаться

Телефон: 8 (812) 309 58 32 (многоканальный)

Факс: 8 (812) 320-02-42

Электронная почта: org@eplast1.ru

Адрес: 198099, г. Санкт-Петербург, ул. Калинина, дом 2, корпус 4, литера А.