

**Table of Contents**

**Z-PACK TinMan High Speed, High Density Backplane Connector** . . . . . 5-48

Introduction . . . . . 6-8

6 Pair Right Angle Receptacle Assemblies . . . . . 9

5 Pair Right Angle Receptacle Assemblies . . . . . 10

4 Pair Right Angle Receptacle Assemblies . . . . . 11

3 Pair Right Angle Receptacle Assemblies . . . . . 12

4 Pair Vertical Receptacle Assemblies . . . . . 13

6 Pair Vertical Header Assemblies . . . . . 14

6 Pair Vertical Header Assemblies — Left End Wall . . . . . 15

6 Pair Vertical Header Assemblies — Right End Wall . . . . . 16

6 Pair Vertical Header Assemblies — Double End Walls . . . . . 17

5 Pair Vertical Header Assemblies . . . . . 18

5 Pair Vertical Header Assemblies — Left End Wall . . . . . 19

5 Pair Vertical Header Assemblies — Right End Wall . . . . . 20

5 Pair Vertical Header Assemblies — Double End Walls . . . . . 21

4 Pair Vertical Header Assemblies . . . . . 22

4 Pair Vertical Header Assemblies — Left End Wall . . . . . 23

4 Pair Vertical Header Assemblies — Right End Wall . . . . . 24

4 Pair Vertical Header Assemblies — Double End Walls . . . . . 25

3 Pair Vertical Header Assemblies . . . . . 26

3 Pair Vertical Header Assemblies — Left End Wall . . . . . 27

3 Pair Vertical Header Assemblies — Right End Wall . . . . . 28

3 Pair Vertical Header Assemblies — Double End Walls . . . . . 29

5 Pair Right Angle Pin Header Assemblies . . . . . 30

5 Pair Right Angle Pin Header Assemblies — Double End Walls . . . . . 31

4 Pair Right Angle Pin Header Assemblies . . . . . 32

4 Pair Right Angle Pin Header Assemblies — Double End Walls . . . . . 33

3 Pair Right Angle Pin Header Assemblies . . . . . 34

3 Pair Right Angle Pin Header Assemblies — Double End Walls . . . . . 35

Z-PACK TinMan Midplane (Orthogonal) Connector Overview . . . . . 36-38

6 Pair Midplane Assemblies . . . . . 39-45

Z-PACK TinMan Product Mating Sequence Chart . . . . . 46

## Introduction

### Product Facts

- 10+ Gbps performance
- 100 ohm Impedance for Differential Pair configuration
- 5 pair version offers 26 pairs/10mm [66 differential pairs/inch] fitting within a 25.40 [1.00] card slot pitch
- 4 pair version offers 21 pairs/10mm [53 differential pairs/inch] fitting within a 20.30 [.800] card slot pitch
- 3 pair version offering 16 pairs/10mm [40 differential pairs/inch] fitting within a 16.25 [.625] card slot pitch
- Right angle pin headers (coplanar) in 3 pair, 4 pair, and 5 pair versions
- Reliable, redundant contact design on every signal contact
- Modular system offered in various column versions
- Meets Industry reliability requirements of Bellcore/Telcordia
- Sequencing for ground and signal contacts
- RoHS Compliant

### Future Product Extensions

- Vertical receptacles
- High speed cable assemblies and hardware

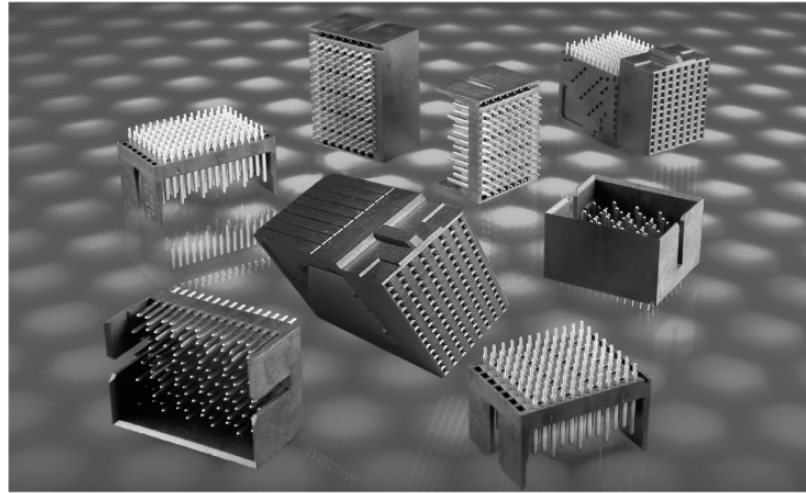

The Z-PACK TinMan backplane connector family is a cost-effective solution for customers searching for a high density, high performance backplane interconnect system.

The Z-PACK TinMan connector design follows proven industry backplane convention by offering a fully protected right-angle receptacle for use on daughter-cards where handling damage can be a concern when mating to a vertical male header. This connector permits field repairability at either the module or single pin levels.

Ground contacts positioned within each column of the connector, combined with unique contact lead frame arrangements, enable the Z-PACK TinMan connector to achieve low crosstalk and high through-put performance levels. Reliability is provided with a dual point of contact mating interface and compliant pin interface to the printed circuit board.

### Industry Applications

Ideally designed for cost pressured, high signal density applications requiring interconnection between two printed circuit boards, such as those typically found in server, storage, switch, router, and similar applications. The Z-PACK TinMan connector product family is suited to meet the demands of today's modular system designs by offering a variety of configurations. The product family includes configurations to fit 20.32 [.800] and 25.40 [1.00] card slot spacing.

### Technical Documents

**Product Specification** 108-2303

**Application Specification** 114-13202

**Routing Guide Report** #27GC001-1

### Material and Finish

**Signal Contact** — High Strength Copper Alloy

**Ground Contact** — High Strength Copper Alloy

**Housing** — Liquid Crystal Polymer, UL 94V-0 Rated

**Platings** — Telcordia compliant interface, Nickel underplate

**Compliant Pin Plating** — RoHS Compliant

### Ratings

**Temperature Range** — -65°C to +90°C

**Current Rating** — 0.5 A/contact @ < 30°C T-Rise

**Durability** — 200 cycles

**Dielectric Withstanding Voltage** — 560 VAC

**Operating Voltage** — 250 VAC max.

### Signal Integrity

**Characteristic Impedance** — Differential @ 100 ohms ±10%

**Crosstalk** — Multi-pair differential crosstalk: 2.1% @ 50ps

**Insertion Loss** — -2 dB @ 10 GHz

**Introduction** (Continued)

**Noise Table**

- Maximum, multiple source crosstalk

Victim Pair	Total Peak Receiver Noise for Recommended Pin-Out
AB9	0.8%
BC8	1.6%
DE9	1.9%
EF8	1.9%
GH9	2.0%
HI8	2.0%
JG9	2.0%
KL8	2.1%
MN9	1.7%
NO8	0.8%

**Note:** Data includes PCB vias of both backplane and daughtercard connectors. Single mated connector pair 50 ps (20-80%) edge rate

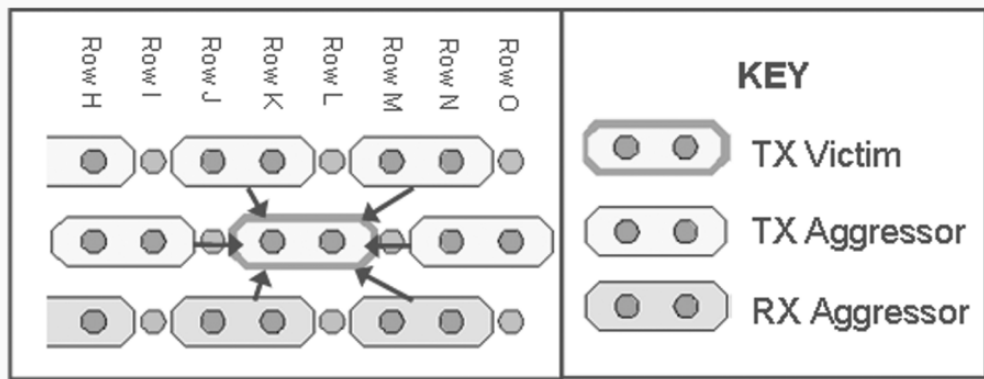

**Insertion Loss Plot**

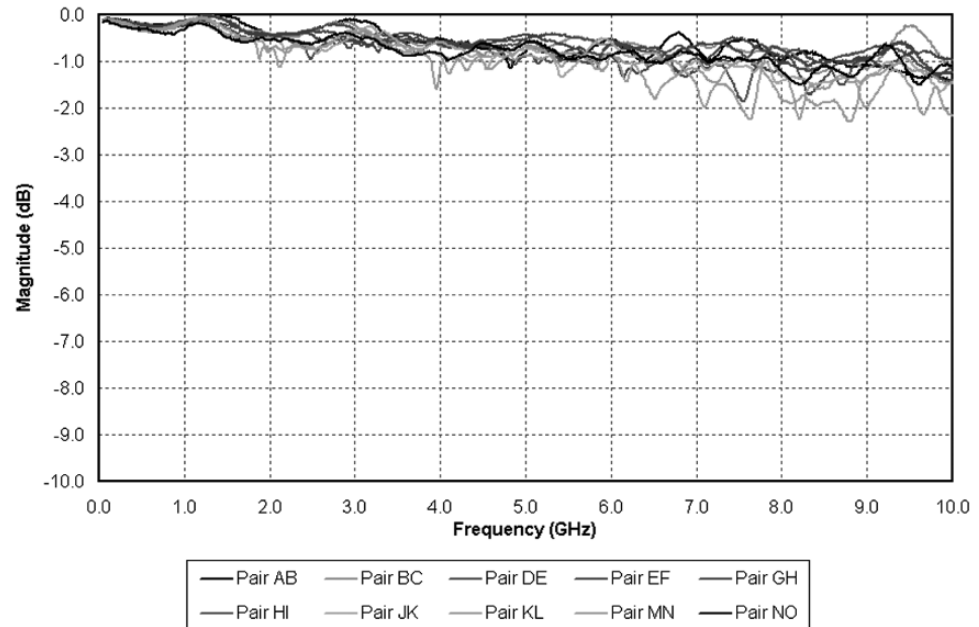

**Introduction** (Continued)

**Representative Eye Pattern**

- 10.0 Gbps data rate
- 2<sup>7</sup>-1 PRBS
- Unequalized Signal

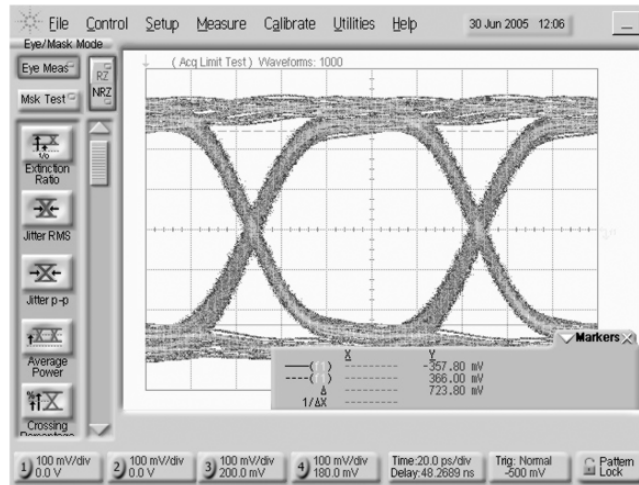

**Customer Connector Evaluation Kit**

- Connector characterization
- Available for loan — contact your local Tyco Electronics Sales Engineer
- Time and frequency domain testable
- Testable to 18+ GHz (25+ Gb/s)
- Multiple calibration options
- Convenient SMA interface

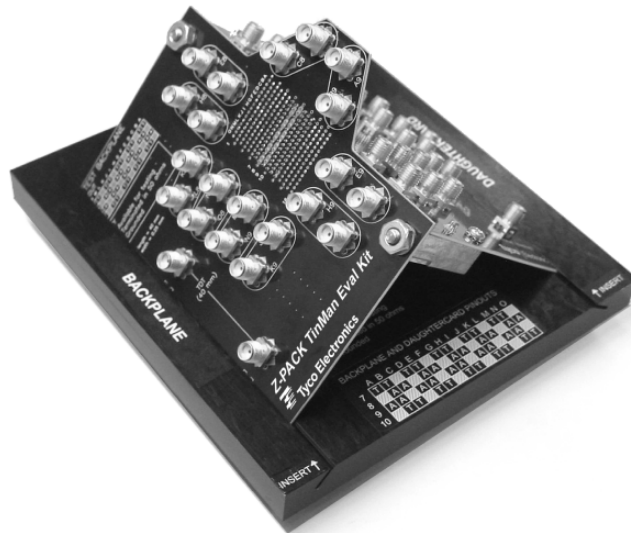

**Customer System Evaluation Kit**

- System characterization
- Available for loan — contact your local Tyco Electronics Sales Engineer
- Time and frequency domain testable
- Testable to 18+ GHz (25+ Gb/s)
- Multiple system lengths
- Convenient SMA interface

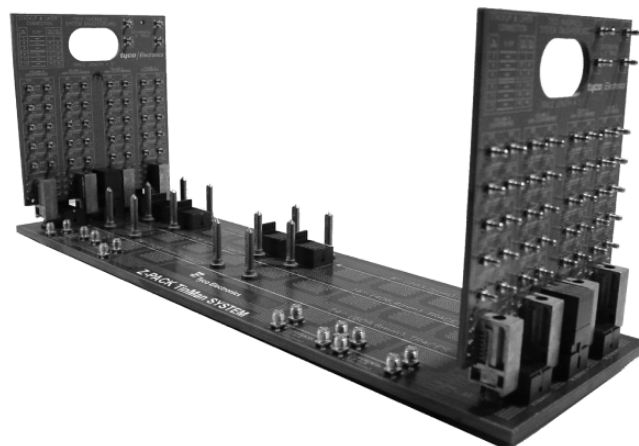

## 6 Pair Right Angle Receptacle Assemblies

Column	Part Number	Dimension		Application Tooling	Mates With
		A	B		
8	1934504-1	15.35 .604	13.30 .524	*	1934505-1, 1934513-1, 1934514-1, 1934515-1
10	2065021-1	19.15 .754	17.10 .673	*	1934520-1, 1934523-1
16	1934912-1	30.55 1.203	28.50 1.122	*	1934516-1, 1934519-1

\* Custom tooling not required. Utilizes flat-rock insertion tooling. Reference Application Specification 114-13202.

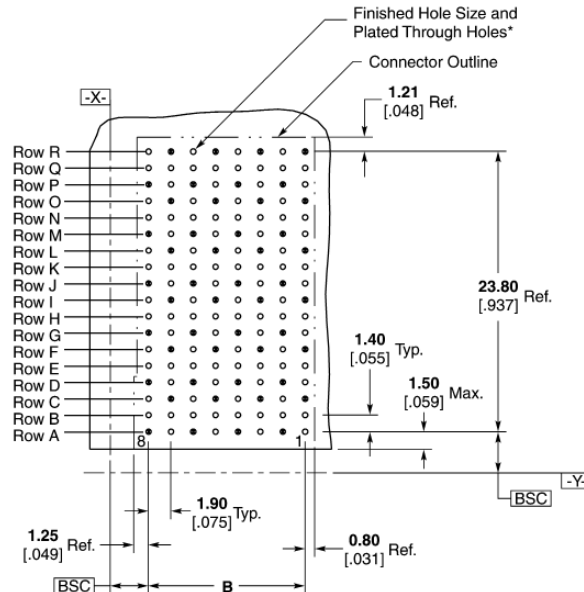
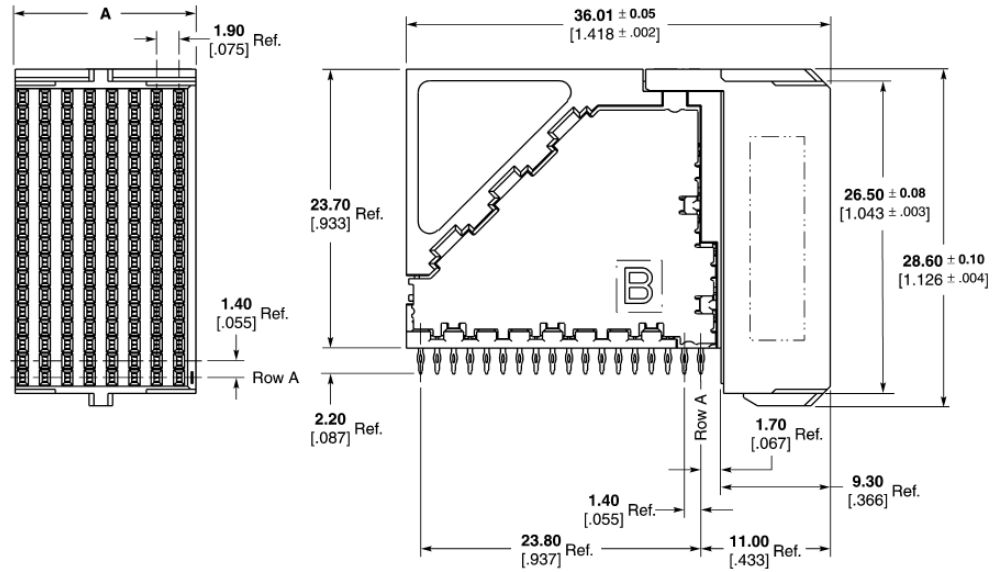

**Recommended PC Board Layout  
Daughterboard  
Component Side Shown**

**Note:** For additional information on pcb routing guidelines, reference the Z-PACK TinMan Connector Routing Guide Report #27GC001-1.

\* Finished Hole Diameter =  $0.46 \pm 0.05$  [0.018 ± .002]  
 Drilled Hole Diameter =  $0.55 \pm 0.02$  [0.022 ± .001]  
 Copper Thickness =  $0.038 \pm 0.013$  [0.0015 ± .0005]  
 Tin-Lead Thickness =  $0.008 \pm 0.004$  [0.0003 ± .0002]  
 Finishes other than Tin-Lead, See Appl. Spec. 114-13202

**Note:** All part numbers are RoHS compliant. Tin-Lead parts are RoHS compliant through exemption for lead in press-fit connectors.

1 Z-PACK TinMan High Speed, High Density Backplane Connector

### 5 Pair Right Angle Receptacle Assemblies

Column	Part Number	Dimension		Application Tooling	Mates With
		A	B		
8	1934218-1	15.35 .604	13.30 .524	*	1934269-1,(R) 1934272-1,(L) 1934273-1, 1934271-1, 1934349-1, 1934350-1
10	1934220-1	19.15 .754	17.10 .673	*	1934325-1, 1934326-1
16	1934221-1	30.55 1.203	28.50 1.122	*	1934331-1, 1934334-1, 1934333-1, 1934332-1, 1934347-1, 1934348-1

\* Custom tooling not required. Utilizes flat-rock insertion tooling. Reference Application Specification 114-13202.

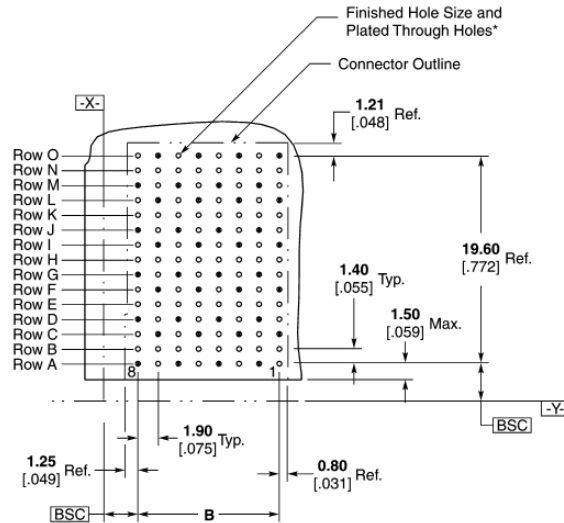
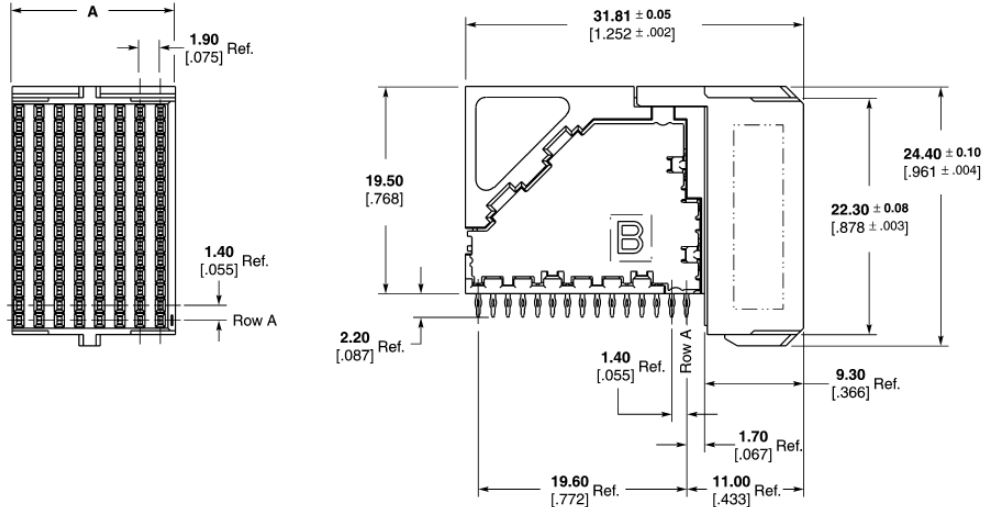

**Recommended PC Board Layout  
Daughterboard  
Component Side Shown**

**Note:** For additional information on pcb routing guidelines, reference the Z-PACK TinMan Connector Routing Guide Report #27GC001-1.

\* Finished Hole Diameter =  $0.46 \pm 0.05$  [0.018 ± .002]  
 Drilled Hole Diameter =  $0.55 \pm 0.02$  [0.022 ± .001]  
 Copper Thickness =  $0.038 \pm 0.013$  [0.0015 ± .0005]  
 Tin-Lead Thickness =  $0.008 \pm 0.004$  [0.0003 ± .0002]  
 Finishes other than Tin-Lead, See Appl. Spec. 114-13202

**Note:** All part numbers are RoHS compliant. Tin-Lead parts are RoHS compliant through exemption for lead in press-fit connectors.

### 4 Pair Right Angle Receptacle Assemblies

Column	Part Number	Dimension		Application Tooling	Mates With
		A	B		
8	1934222-1	15.35 .604	13.30 .524	*	1934304-1, 1934303-1, 1934305-1, 1934306-1, 1934353-1, 1934354-1
10	1934224-1	19.15 .754	17.10 .673	*	1934311-1, 1934312-1, 1934313-1, 1934314-1
16	1934225-1	30.55 1.203	28.50 1.122	*	1934315-1, 1934318-1, 1934317-1, 1934316-1, 1934351-1, 1934352-1

\* Custom tooling not required. Utilizes flat-rock insertion tooling. Reference Application Specification 114-13202.

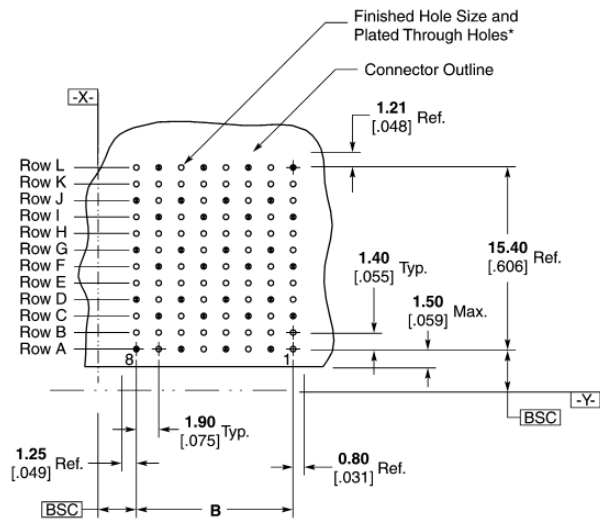
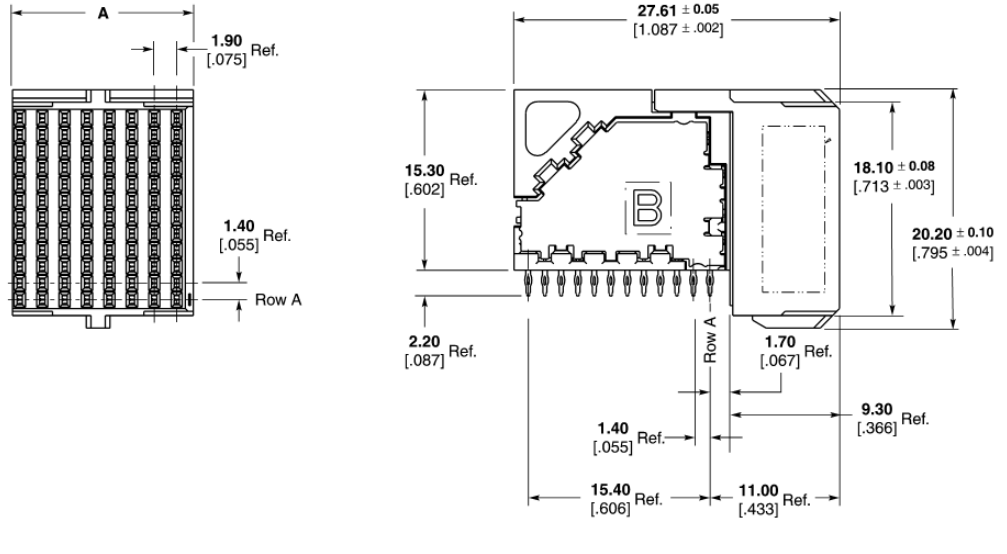

**Recommended PC Board Layout  
Daughterboard  
Component Side Shown**

**Note:** For additional information on pcb routing guidelines, reference the Z-PACK TinMan Connector Routing Guide Report #27GC001-1.

\* Finished Hole Diameter =  $0.46 \pm 0.05$  [0.018 ± 0.002]  
 Drilled Hole Diameter =  $0.55 \pm 0.02$  [0.022 ± 0.001]  
 Copper Thickness =  $0.038 \pm 0.013$  [0.0015 ± 0.0005]  
 Tin-Lead Thickness =  $0.008 \pm 0.004$  [0.0003 ± 0.0002]  
 Finishes other than Tin-Lead, See Appl. Spec. 114-13202

**Note:** All part numbers are RoHS compliant. Tin-Lead parts are RoHS compliant through exemption for lead in press-fit connectors.

### 3 Pair Right Angle Receptacle Assemblies

Column	Part Number	Dimension		Application Tooling	Mates With
		A	B		
8	1934226-1	15.35 .604	13.30 .524	*	1934299-1, 1934300-1, 1934301-1, 1934302-1, 1934359-1, 1934360-1
10	1934228-1	19.15 .754	17.10 .673	*	1934339-1, 1934341-1, 1934340-1, 1934342-1, 1934357-1, 1934358-1
16	1934229-1	30.55 1.203	28.50 1.122	*	1934343-1, 1934344-1, 1934345-1, 1934346-1, 1934355-1, 1934356-1

\* Custom tooling not required. Utilizes flat-rock insertion tooling. Reference Application Specification 114-13202.

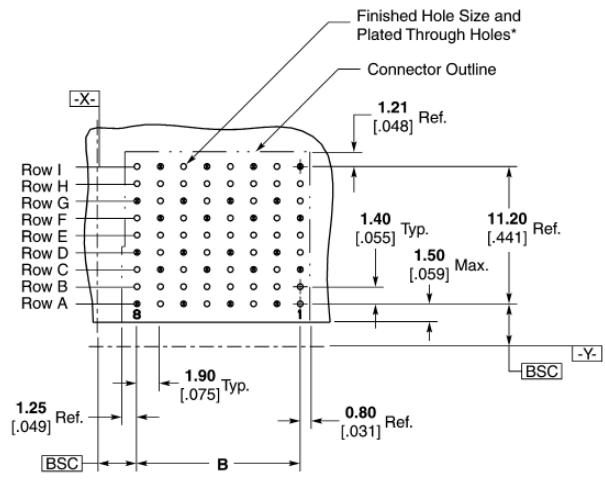
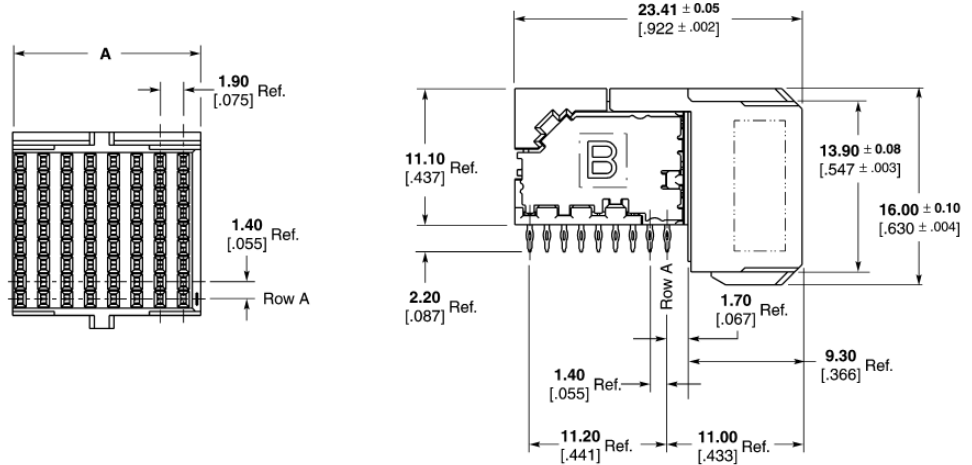

**Recommended PC Board Layout  
Daughterboard  
Component Side Shown**

**Note:** For additional information on pcb routing guidelines, reference the Z-PACK TinMan Connector Routing Guide Report #27GC001-1.

\* Finished Hole Diameter =  $0.46 \pm 0.05$  [.018 ± .002]  
 Drilled Hole Diameter =  $0.55 \pm 0.02$  [.022 ± .001]  
 Copper Thickness =  $0.038 \pm 0.013$  [.0015 ± .0005]  
 Tin-Lead Thickness =  $0.008 \pm 0.004$  [.0003 ± .0002]  
 Finishes other than Tin-Lead, See Appl. Spec. 114-13202

**Note:** All part numbers are RoHS compliant. Tin-Lead parts are RoHS compliant through exemption for lead in press-fit connectors.



### 4 Pair Vertical Receptacle Assemblies

Column	Part Number	Dimension		Application Tooling	Mates With
		A	B		
8	1934593-1	15.35 .605	13.30 .524	*	1934305-1, 1934303-1, 1934304-1, 1934306-1, 1934353-1, 1934354-1
10	1934544-1	19.15 .754	17.10 .673	*	1934311-1, 1934313-1, 1934314-1, 1934312-1
16	1934594-1	30.70 1.210	28.50 1.122	*	1934315-1, 1934317-1, 1934318-1, 1934316-1, 1934351-1, 1934352-1

\* Custom tooling not required. Utilizes flat-rock insertion tooling. Reference Application Specification 114-13202.

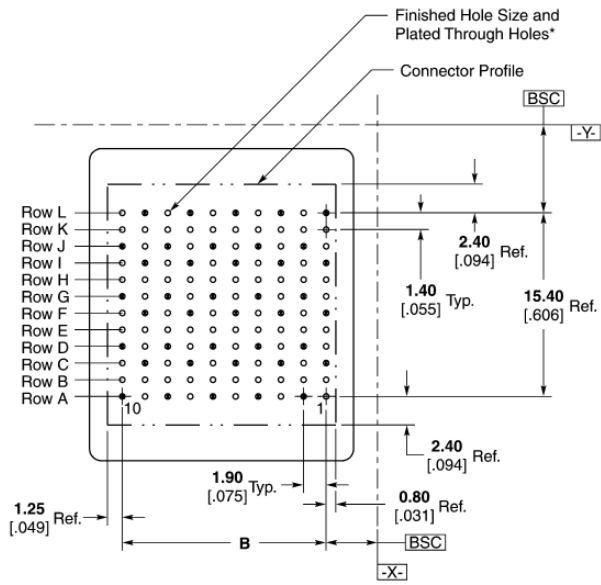
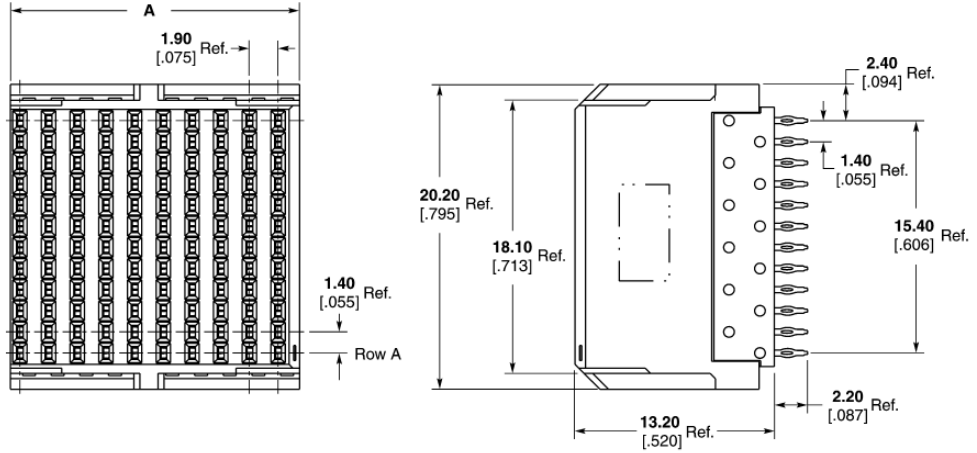

Recommended PC Board Layout  
Component Side Shown

**Note:** For additional information on pcb routing guidelines, reference the Z-PACK TinMan Connector Routing Guide Report #27GC001-1.

\* Finished Hole Diameter =  $0.46 \pm 0.05$  [0.018 ± 0.002]  
 Drilled Hole Diameter =  $0.55 \pm 0.02$  [0.022 ± 0.001]  
 Copper Thickness =  $0.038 \pm 0.013$  [0.0015 ± 0.0005]  
 Tin-Lead Thickness =  $0.008 \pm 0.004$  [0.0003 ± 0.0002]  
 Finishes other than Tin-Lead, See Appl. Spec. 114-13202

**Note:** All part numbers are RoHS compliant. Tin-Lead parts are RoHS compliant through exemption for lead in press-fit connectors.

### 6 Pair Vertical Header Assemblies

Column	Part Number	Dimension		Application Tooling	Mates With
		A	B		
8	1934505-1	15.35 .604	13.30 .524	2063383-1	1934504-1
10	1934520-1	19.15 .754	17.10 .673	2063383-2	2065021-1
16	1934516-1	30.55 1.203	28.50 1.122	2063383-3	1934912-1

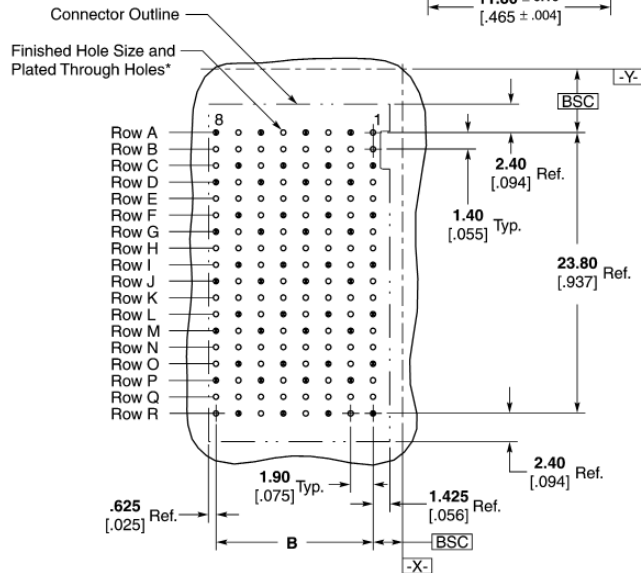
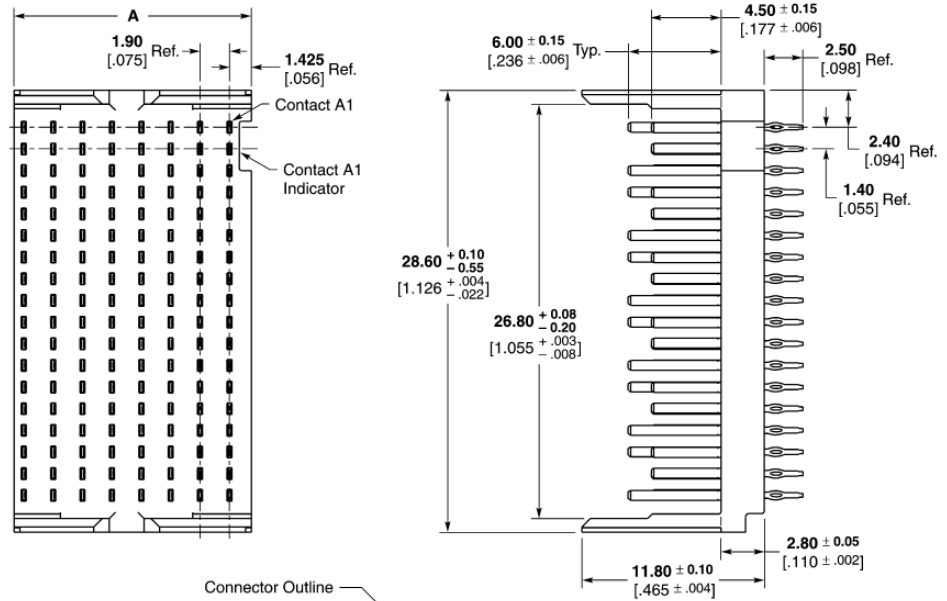

**Recommended PC Board Layout Backplane Component Side Shown**

**Note:** For additional information on pcb routing guidelines, reference the Z-PACK TinMan Connector Routing Guide Report #27GC001-1.

\* Finished Hole Diameter =  $0.46 \pm 0.05$  [0.018 ±.002]  
 Drilled Hole Diameter =  $0.55 \pm 0.02$  [0.022 ±.001]  
 Copper Thickness =  $0.038 \pm 0.013$  [0.0015 ±.0005]  
 Tin-Lead Thickness =  $0.008 \pm 0.004$  [0.0003 ±.0002]  
 Finishes other than Tin-Lead, See Appl. Spec. 114-13202

**Note:** All part numbers are RoHS compliant. Tin-Lead parts are RoHS compliant through exemption for lead in press-fit connectors.

**6 Pair Vertical Header Assemblies — Left End Wall**

Column	Part Number	Dimension		Application Tooling	Mates With
		A	B		
8	1934513-1	16.30 .642	13.30 .524	2063383-1	1934504-1

1  
Z-PACK TinMan High Speed, High Density Backplane Connector

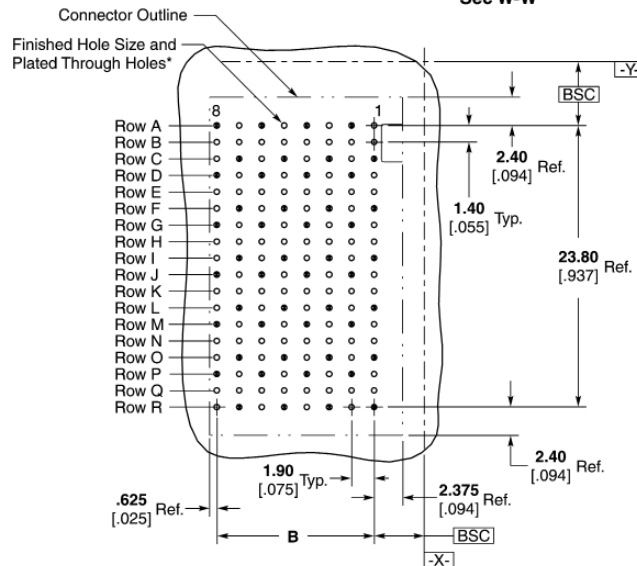
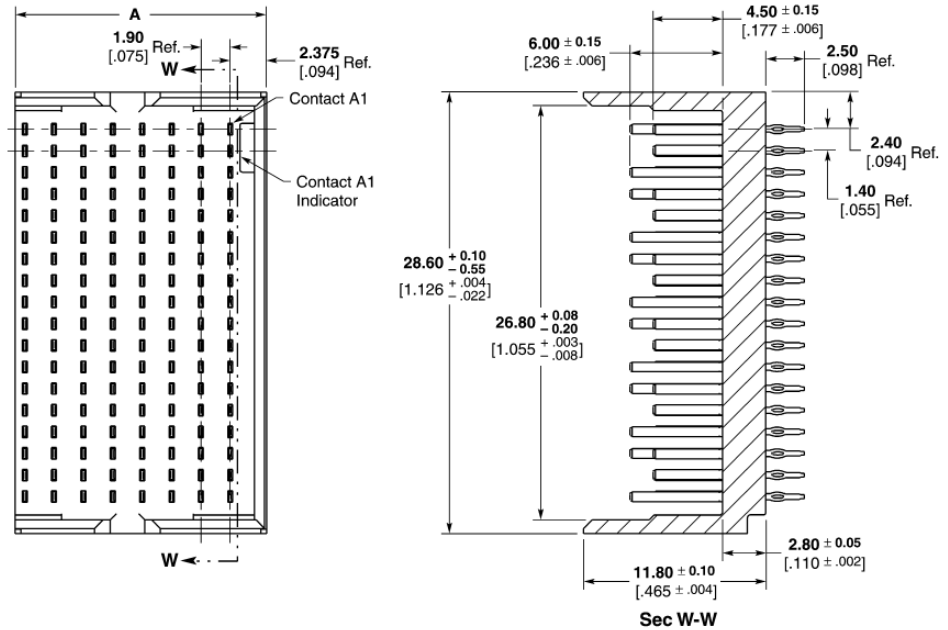

**Recommended PC Board Layout  
Backplane  
Component Side Shown**

**Note:** For additional information on pcb routing guidelines, reference the Z-PACK TinMan Connector Routing Guide Report #27GC001-1.

\* Finished Hole Diameter =  $0.46 \pm 0.05$  [0.018 ± 0.002]  
 Drilled Hole Diameter =  $0.55 \pm 0.02$  [0.022 ± 0.001]  
 Copper Thickness =  $0.038 \pm 0.013$  [0.0015 ± 0.0005]  
 Tin-Lead Thickness =  $0.008 \pm 0.004$  [0.0003 ± 0.0002]  
 Finishes other than Tin-Lead, See Appl. Spec. 114-13202

**Note:** All part numbers are RoHS compliant. Tin-Lead parts are RoHS compliant through exemption for lead in press-fit connectors.

## 6 Pair Vertical Header Assemblies — Right End Wall

Column	Part Number	Dimension		Application Tooling	Mates With
		A	B		
8	1934514-1	17.60 .693	13.30 .524	2063383-1	1934504-1

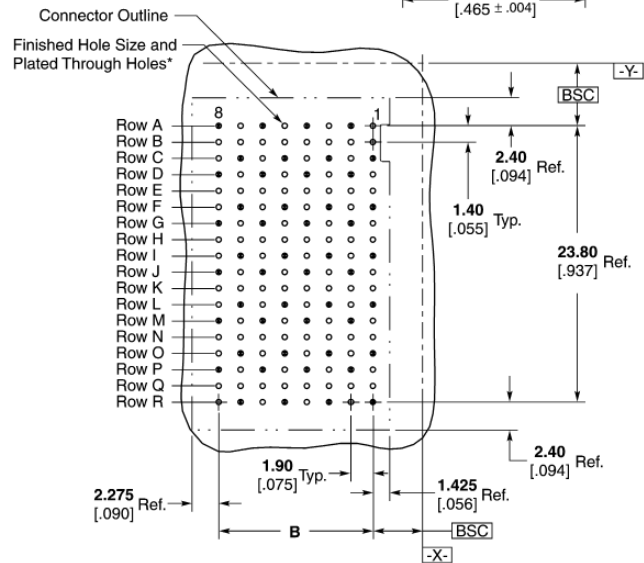
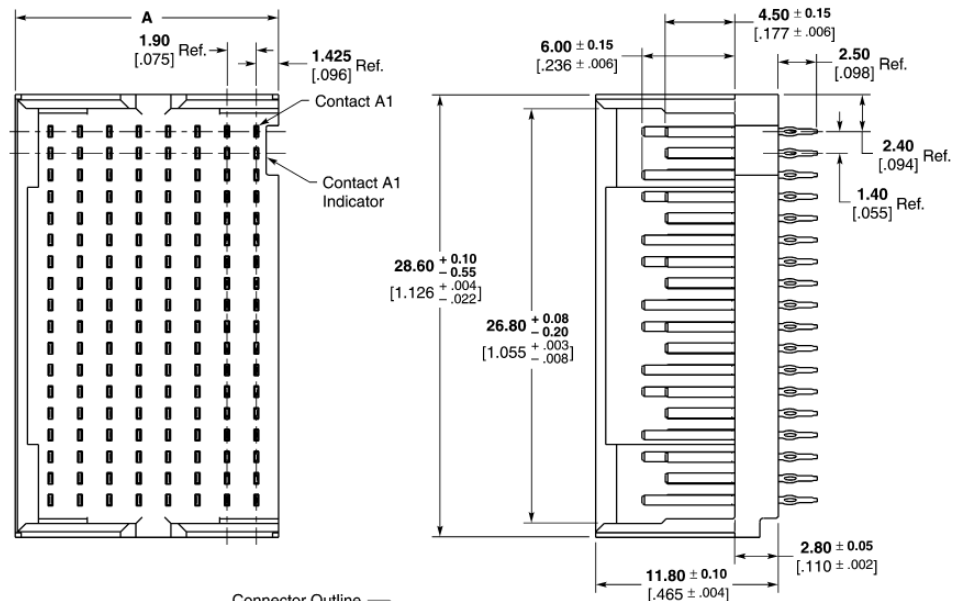

**Recommended PC Board Layout  
Backplane  
Component Side Shown**

**Note:** For additional information on pcb routing guidelines, reference the Z-PACK Tin-Mat Connector Routing Guide Report #27GC001-1.

\* Finished Hole Diameter =  $0.46 \pm 0.05$  [.018 ± .002]  
 Drilled Hole Diameter =  $0.55 \pm 0.02$  [.022 ± .001]  
 Copper Thickness =  $0.038 \pm 0.013$  [.0015 ± .0005]  
 Tin-Lead Thickness =  $0.008 \pm 0.004$  [.0003 ± .0002]  
 Finishes other than Tin-Lead, See Appl. Spec. 114-13202

**Note:** All part numbers are RoHS compliant. Tin-Lead parts are RoHS compliant through exemption for lead in press-fit connectors.

**6 Pair Vertical Header Assemblies — Double End Walls**

1 Z-PACK TinMan High Speed, High Density Backplane Connector

Column	Part Number	Dimension		Application Tooling	Mates With
		A	B		
8	1934515-1	17.95 .707	13.30 .524	2063383-1	1934504-1
10	1934523-1	21.75 .856	17.10 .673	2063383-2	2065021-1
16	1934519-1	33.15 1.305	28.50 1.122	2063383-3	1934912-1

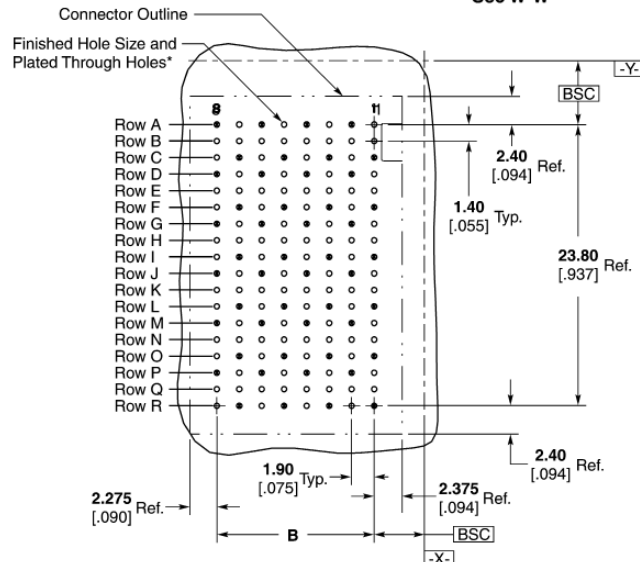
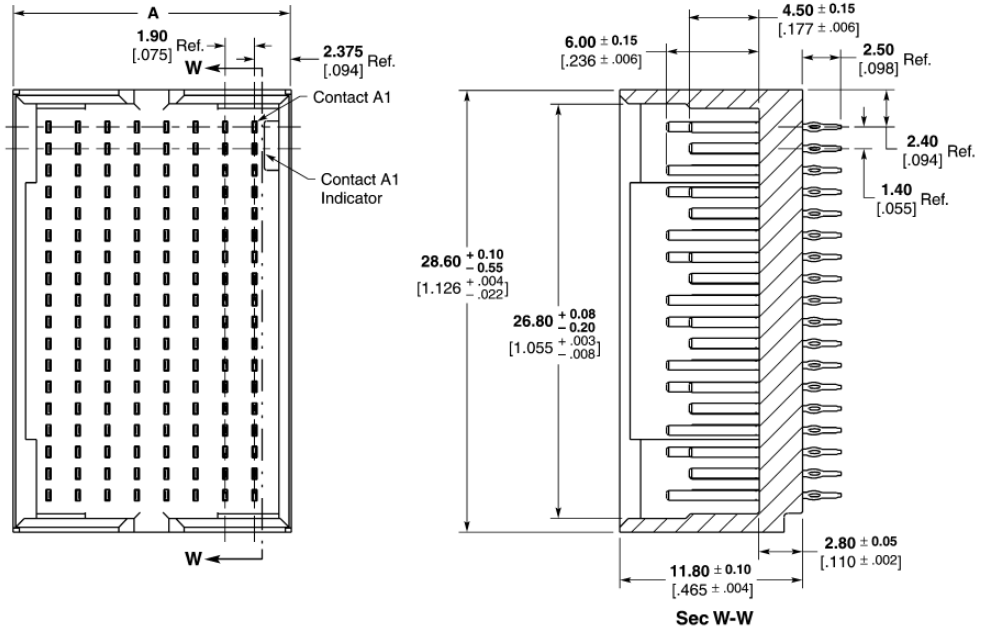

**Recommended PC Board Layout Backplane Component Side Shown**

**Note:** For additional information on pcb routing guidelines, reference the Z-PACK TinMan Connector Routing Guide Report #27GC001-1.

\* Finished Hole Diameter =  $0.46 \pm 0.05$  [0.018 ± 0.002]  
 Drilled Hole Diameter =  $0.55 \pm 0.02$  [0.022 ± 0.001]  
 Copper Thickness =  $0.038 \pm 0.013$  [0.0015 ± 0.0005]  
 Tin-Lead Thickness =  $0.008 \pm 0.004$  [0.0003 ± 0.0002]  
 Finishes other than Tin-Lead, See Appl. Spec. 114-13202

**Note:** All part numbers are RoHS compliant. Tin-Lead parts are RoHS compliant through exemption for lead in press-fit connectors.

## 5 Pair Vertical Header Assemblies

Column	Part Number	Dimension		Application Tooling*	Mates With
		A	B		
8	1934269-1	15.35 .604	13.30 .524	1-1804791-1	1934218-1
10	1934325-1	19.15 .754	17.10 .673	1-1804791-7	1934220-1
16	1934331-1	30.55 1.203	28.50 1.122	1-1804791-3	1934221-1

\* Reference Application Specification 114-13202.

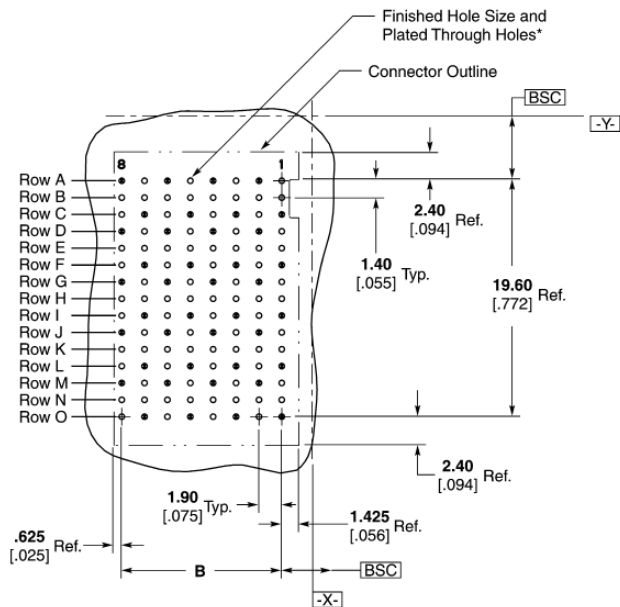
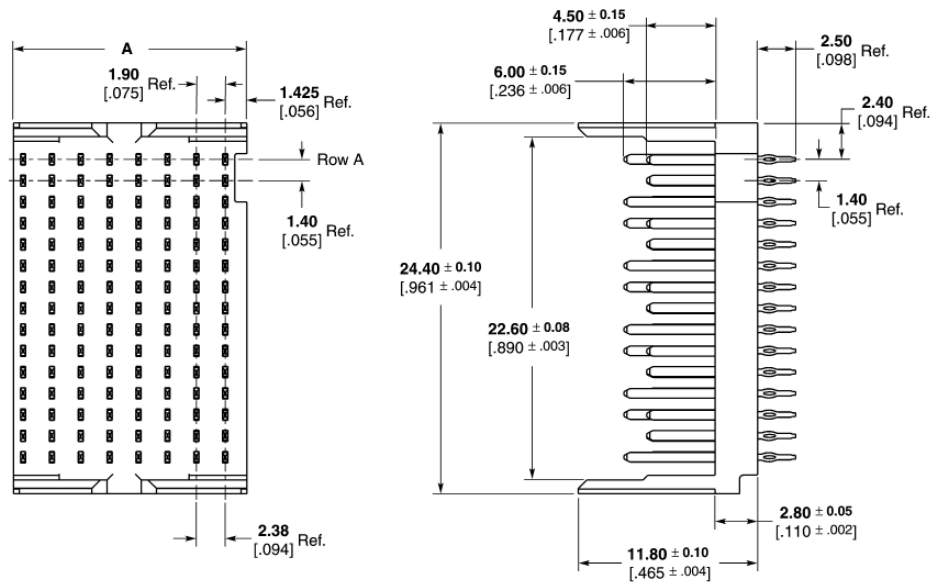

**Recommended PC Board Layout  
Backplane  
Component Side Shown**

**Note:** All part numbers are RoHS compliant. Tin-Lead parts are RoHS compliant through exemption for lead in press-fit connectors.

**Note:** For additional information on pcb routing guidelines, reference the Z-PACK TinMan Connector Routing Guide Report #27GC001-1.

\* Finished Hole Diameter =  $0.46 \pm 0.05$  [0.018 ± 0.002]  
Drilled Hole Diameter =  $0.55 \pm 0.02$  [0.022 ± 0.001]  
Copper Thickness =  $0.038 \pm 0.013$  [0.0015 ± 0.0005]  
Tin-Lead Thickness =  $0.008 \pm 0.004$  [0.0003 ± 0.0002]  
Finishes other than Tin-Lead, See Appl. Spec. 114-13202

### 5 Pair Vertical Header Assemblies — Left End Wall

1 Z-PACK TinMan High Speed, High Density Backplane Connector

Column	Part Number	Dimension		Application Tooling*	Mates With
		A	B		
8	1934272-1	16.30 .642	13.30 .524	1-1804791-1	1934218-1
16	1934333-1	31.50 1.240	28.50 1.122	1-1804791-3	1934221-1

\* Reference Application Specification 114-13202.

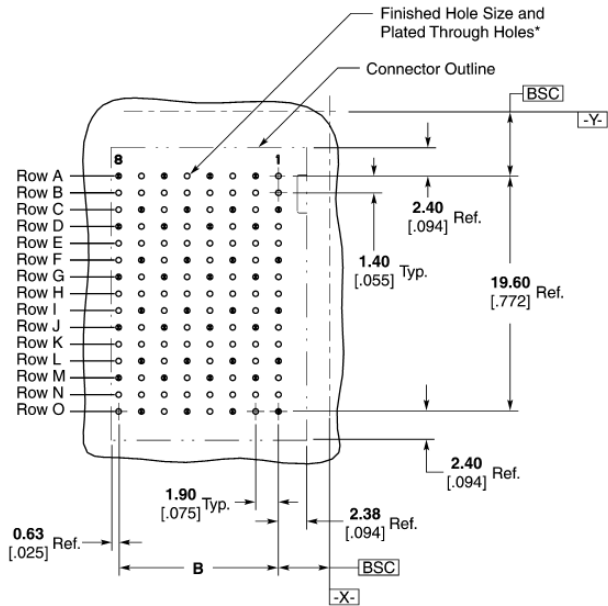
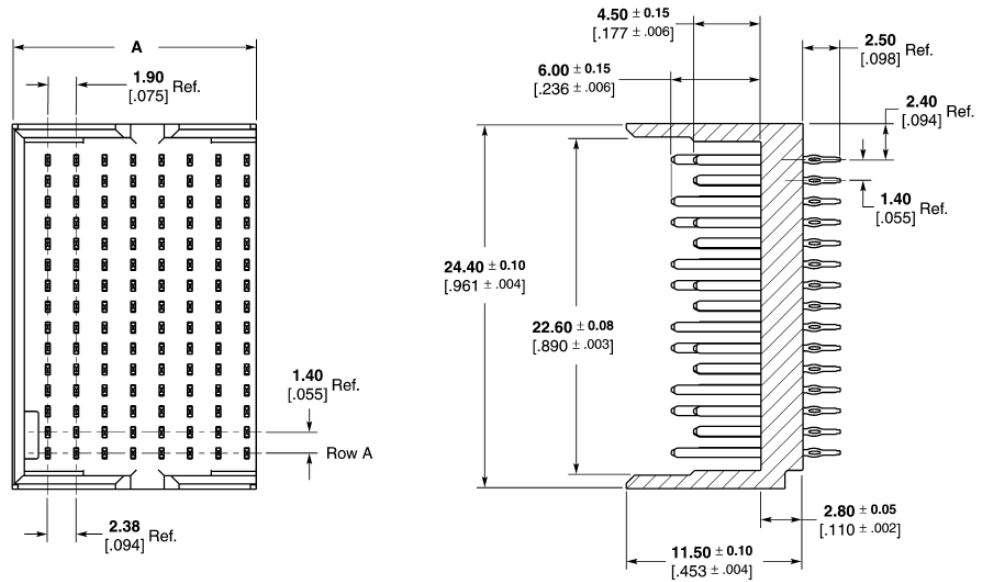

**Recommended PC Board Layout  
Backplane  
Component Side Shown**

**Note:** For additional information on pcb routing guidelines, reference the Z-PACK TinMan Connector Routing Guide Report #27GC001-1.

\* Finished Hole Diameter =  $0.46 \pm 0.05$  [0.018 ± 0.002]  
 Drilled Hole Diameter =  $0.55 \pm 0.02$  [0.022 ± 0.001]  
 Copper Thickness =  $0.038 \pm 0.013$  [0.015 ± 0.0005]  
 Tin-Lead Thickness =  $0.008 \pm 0.004$  [0.0003 ± 0.0002]  
 Finishes other than Tin-Lead, See Appl. Spec. 114-13202

**Note:** All part numbers are RoHS compliant. Tin-Lead parts are RoHS compliant through exemption for lead in press-fit connectors.

## 5 Pair Vertical Header Assemblies — Right End Wall

Column	Part Number	Dimension		Application Tooling*	Mates With
		A	B		
8	1934273-1	17.00 .669	13.30 .524	1-1804791-1	1934218-1
16	1934334-1	32.20 1.268	28.50 1.122	1-1804791-3	1934221-1

\* Reference Application Specification 114-13202.

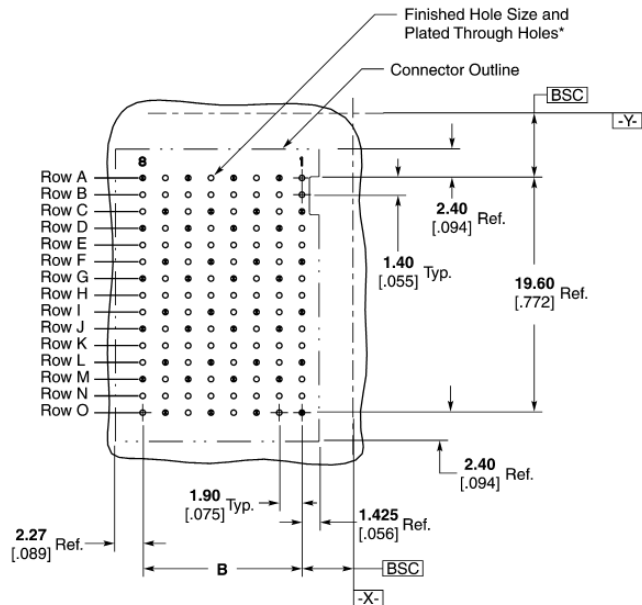
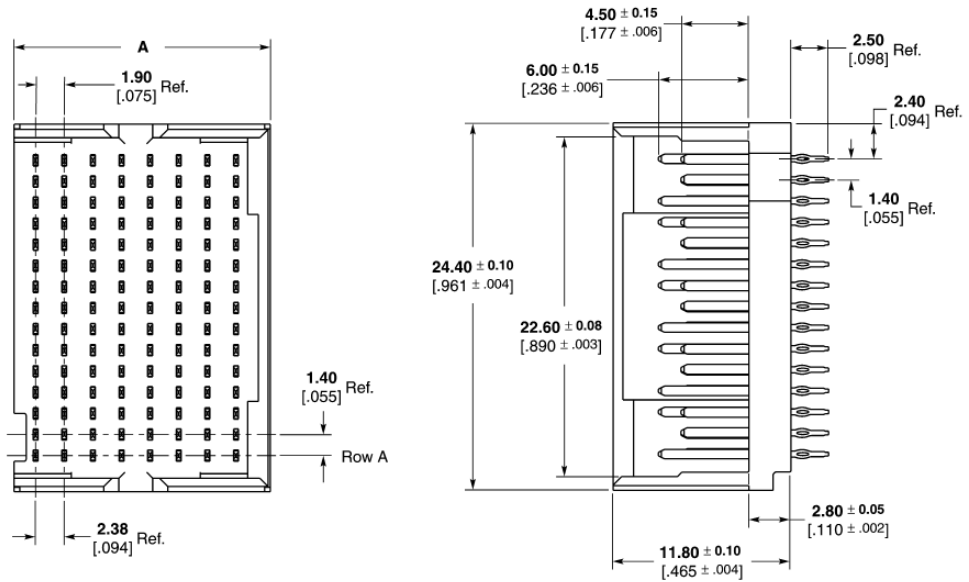

**Recommended PC Board Layout  
Backplane  
Component Side Shown**

**Note:** For additional information on pcb routing guidelines, reference the Z-PACK TinMan Connector Routing Guide Report #27GC001-1.

\* Finished Hole Diameter =  $0.46 \pm 0.05$  [0.018 ± 0.002]  
 Drilled Hole Diameter =  $0.55 \pm 0.02$  [0.022 ± 0.001]  
 Copper Thickness =  $0.038 \pm 0.013$  [0.0015 ± 0.0005]  
 Tin-Lead Thickness =  $0.008 \pm 0.004$  [0.0003 ± 0.0002]  
 Finishes other than Tin-Lead, See Appl. Spec. 114-13202

**Note:** All part numbers are RoHS compliant. Tin-Lead parts are RoHS compliant through exemption for lead in press-fit connectors.



**5 Pair Vertical Header Assemblies — Double End Walls**

Column	Part Number	Dimension		Application Tooling*	Mates With
		A	B		
8	1934271-1	17.95 .707	13.30 .524	1-1804791-1	1934218-1
10	1934326-1	21.75 .856	17.10 .673	1-1804791-7	1934220-1
16	1934332-1	33.15 1.305	28.50 1.122	1-1804791-3	1934221-1

\* Reference Application Specification 114-13202.

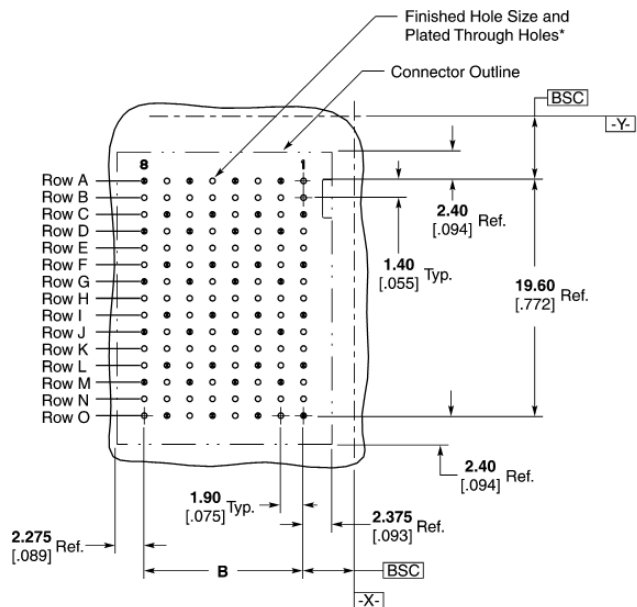
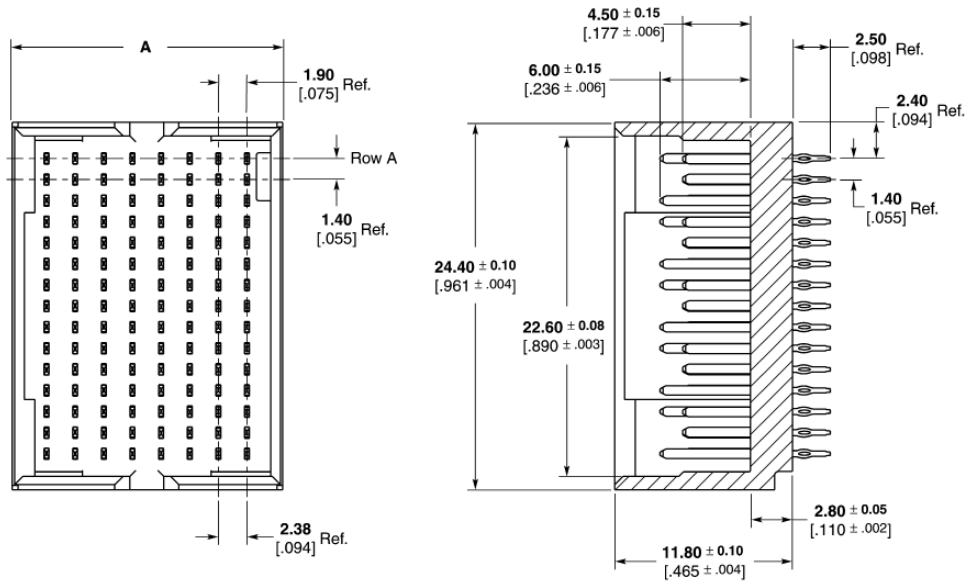

**Recommended PC Board Layout  
Backplane  
Component Side Shown**

**Note:** All part numbers are RoHS compliant. Tin-Lead parts are RoHS compliant through exemption for lead in press-fit connectors.

**Note:** For additional information on pcb routing guidelines, reference the Z-PACK TinMan Connector Routing Guide Report #27GC001-1.

\* Finished Hole Diameter =  $0.46 \pm 0.05$  [0.018 ± 0.002]  
 Drilled Hole Diameter =  $0.55 \pm 0.02$  [0.022 ± 0.001]  
 Copper Thickness =  $0.038 \pm 0.013$  [0.015 ± 0.0005]  
 Tin-Lead Thickness =  $0.008 \pm 0.004$  [0.0003 ± 0.0002]  
 Finishes other than Tin-Lead, See Appl. Spec. 114-13202

### 4 Pair Vertical Header Assemblies

Column	Part Number	Dimension		Application Tooling*	Mates With
		A	B		
8	1934305-1	15.35 .604	13.30 .524	1-1804790-1	1934222-1
10	1934311-1	19.15 .754	17.10 .673	1804790-5	1934224-1
16	1934315-1	30.55 1.202	28.50 1.122	1-1804790-3	1934225-1

\* Reference Application Specification 114-13202.

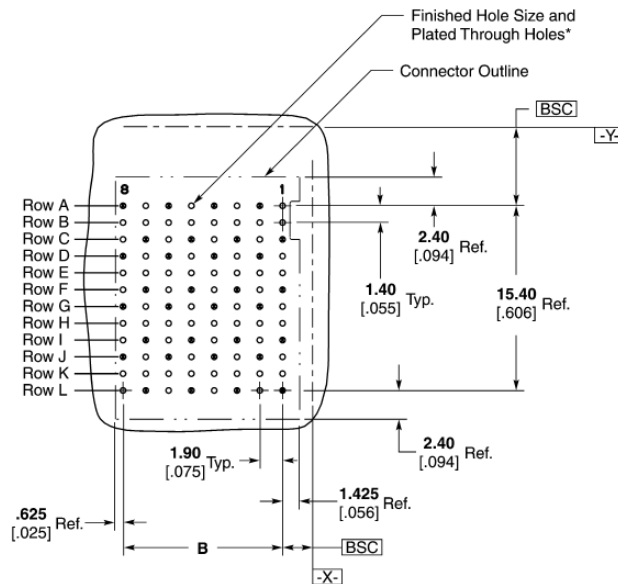
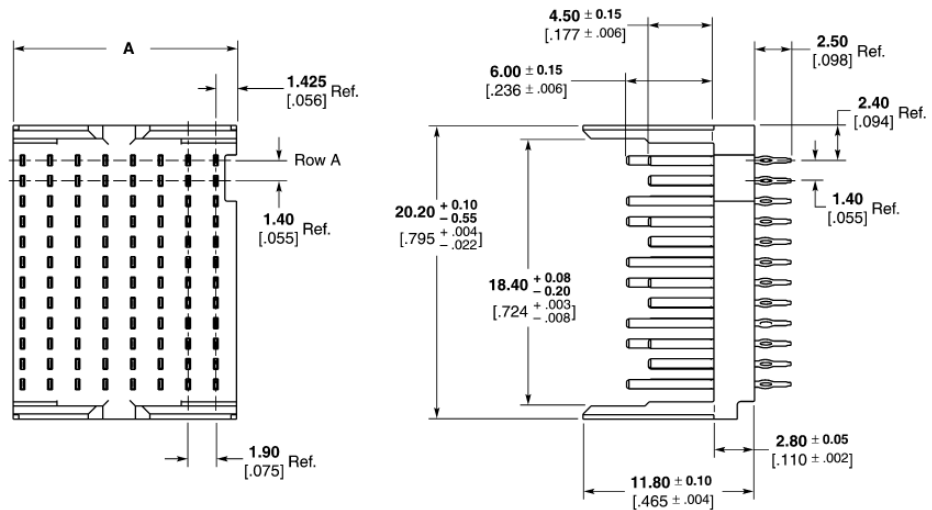

**Recommended PC Board Layout  
Backplane  
Component Side Shown**

**Note:** For additional information on pcb routing guidelines, reference the Z-PACK TinMan Connector Routing Guide Report #27GC001-1.

\* Finished Hole Diameter =  $0.46 \pm 0.05$  [.018 ± .002]  
 Drilled Hole Diameter =  $0.55 \pm 0.02$  [.022 ± .001]  
 Copper Thickness =  $0.038 \pm 0.013$  [.0015 ± .0005]  
 Tin-Lead Thickness =  $0.008 \pm 0.004$  [.0003 ± .0002]  
 Finishes other than Tin-Lead, See Appl. Spec. 114-13202

**Note:** All part numbers are RoHS compliant. Tin-Lead parts are RoHS compliant through exemption for lead in press-fit connectors.

**4 Pair Vertical Header Assemblies — Left End Wall**

Column	Part Number	Dimension		Application Tooling*	Mates With
		A	B		
8	1934303-1	17.00 .669	13.30 .524	1-1804790-1	1934222-1
16	1934317-1	31.50 1.240	28.50 1.122	1-1804790-3	1934225-1

\* Reference Application Specification 114-13202.

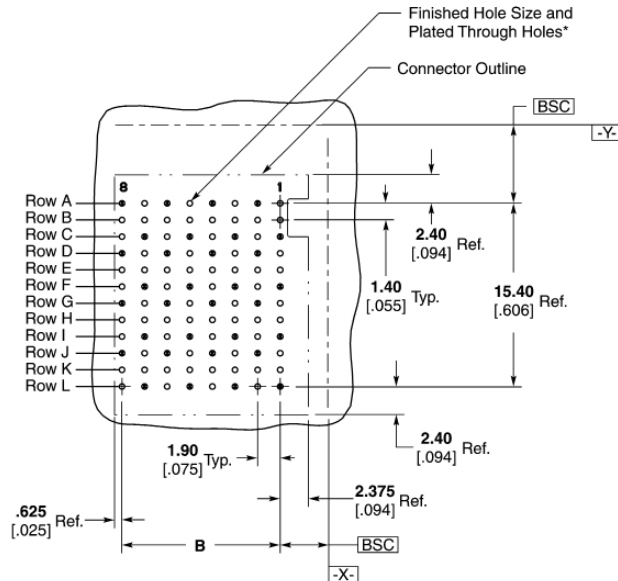
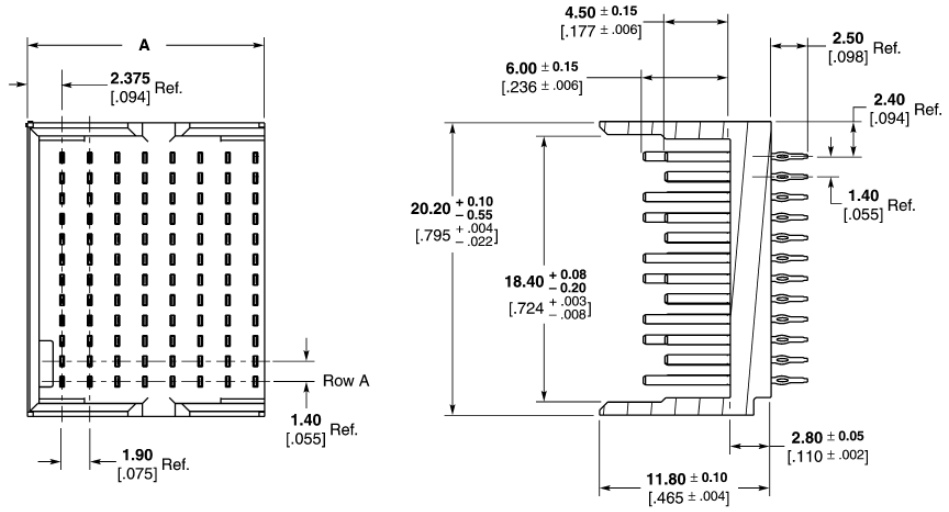

**Recommended PC Board Layout Backplane Component Side Shown**

**Note:** For additional information on pcb routing guidelines, reference the Z-PACK TinMan Connector Routing Guide Report #27GC001-1.

\* Finished Hole Diameter =  $0.46 \pm 0.05$  [.018 ± .002]  
 Drilled Hole Diameter =  $0.55 \pm 0.02$  [.022 ± .001]  
 Copper Thickness =  $0.038 \pm 0.013$  [.0015 ± .0005]  
 Tin-Lead Thickness =  $0.008 \pm 0.004$  [.0003 ± .0002]  
 Finishes other than Tin-Lead, See Appl. Spec. 114-13202

**Note:** All part numbers are RoHS compliant. Tin-Lead parts are RoHS compliant through exemption for lead in press-fit connectors.

### 4 Pair Vertical Header Assemblies — Right End Wall

Column	Part Number	Dimension		Application Tooling*	Mates With
		A	B		
8	1934304-1	16.30 .642	13.30 .524	1-1804790-1	1934222-1
16	1934318-1	32.20 1.268	28.50 1.122	1-1804790-3	1934225-1

\* Reference Application Specification 114-13202.

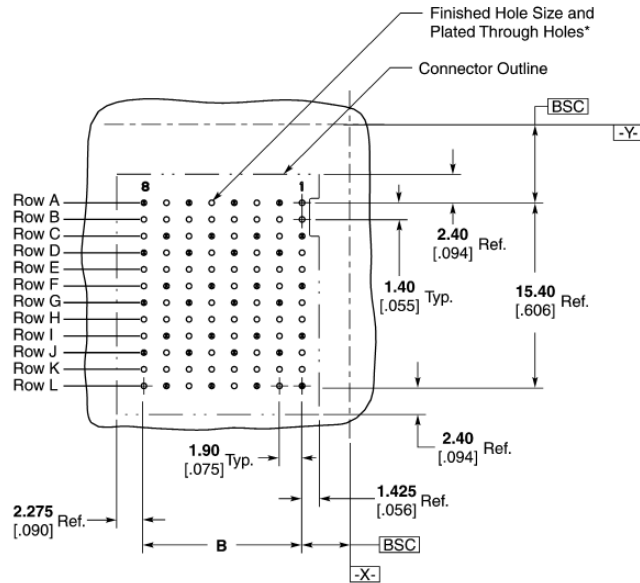
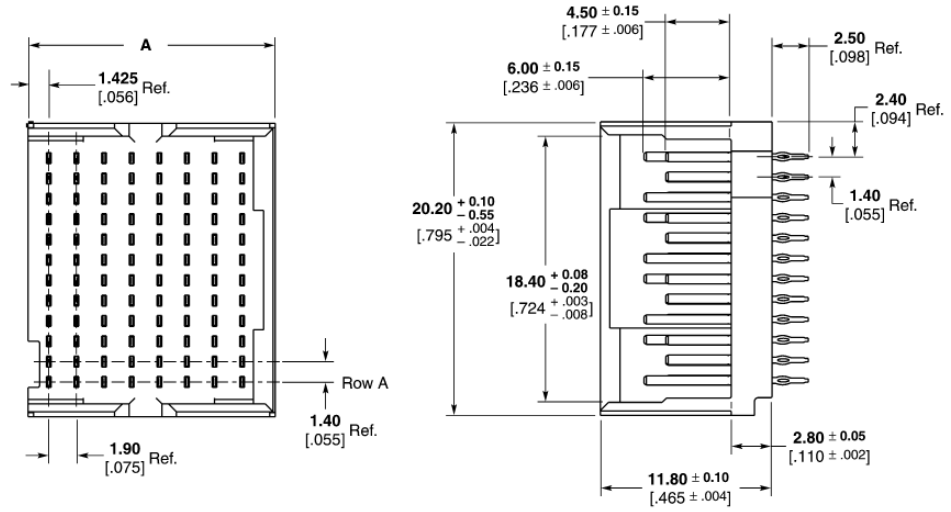

**Recommended PC Board Layout  
Backplane  
Component Side Shown**

**Note:** For additional information on pcb routing guidelines, reference the Z-PACK TinMan Connector Routing Guide Report #27GC001-1.

\* Finished Hole Diameter =  $0.46 \pm 0.05$  [.018 ± .002]  
 Drilled Hole Diameter =  $0.55 \pm 0.02$  [.022 ± .001]  
 Copper Thickness =  $0.038 \pm 0.013$  [.0015 ± .0005]  
 Tin-Lead Thickness =  $0.008 \pm 0.004$  [.0003 ± .0002]  
 Finishes other than Tin-Lead, See Appl. Spec. 114-13202

**Note:** All part numbers are RoHS compliant. Tin-Lead parts are RoHS compliant through exemption for lead in press-fit connectors.

### 4 Pair Vertical Header Assemblies — Double End Walls

1 Z-PACK TinMan High Speed, High Density Backplane Connector

Column	Part Number	Dimension		Application Tooling*	Mates With
		A	B		
8	1934306-1	17.95 .707	13.30 .524	1-1804790-1	1934222-1
10	1934312-1	21.75 .856	17.10 .673	1804790-5	1934224-1
16	1934316-1	33.15 1.305	28.50 1.122	1-1804790-3	1934225-1

\* Reference Application Specification 114-13202.

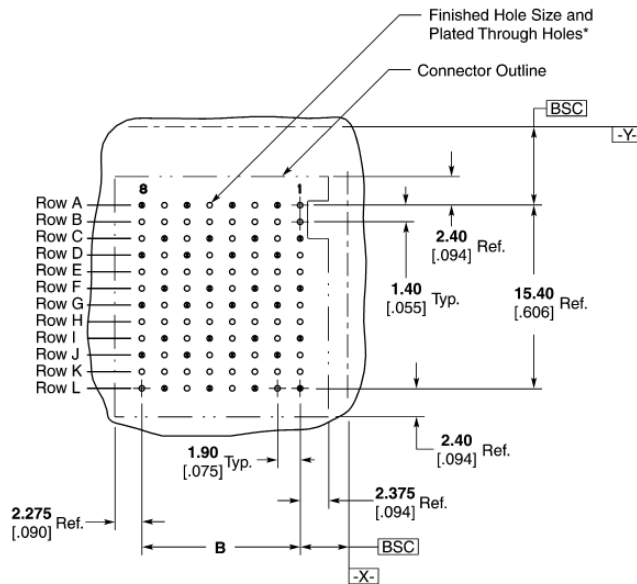
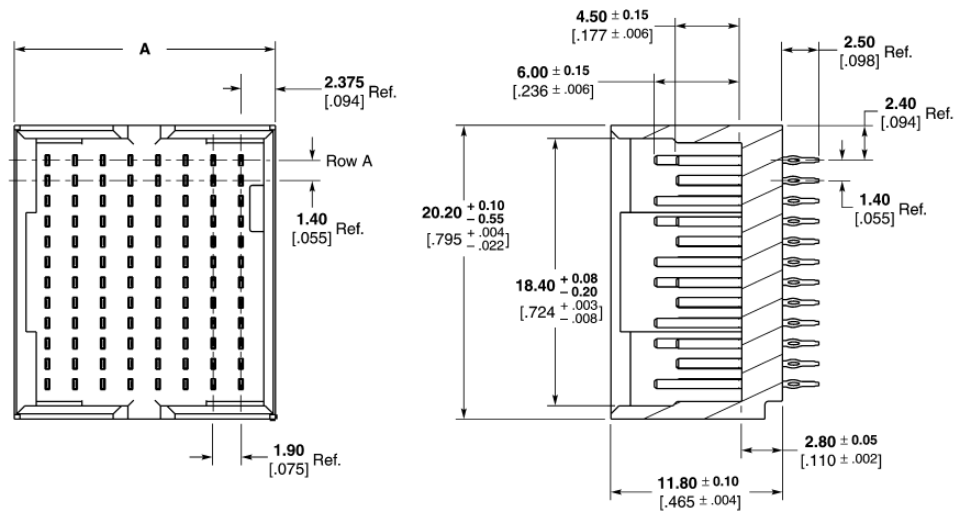

**Recommended PC Board Layout  
Backplane  
Component Side Shown**

**Note:** For additional information on pcb routing guidelines, reference the Z-PACK TinMan Connector Routing Guide Report #27GC001-1.

\* Finished Hole Diameter =  $0.46 \pm 0.05$  [.018 ± .002]  
 Drilled Hole Diameter =  $0.55 \pm 0.02$  [.022 ± .001]  
 Copper Thickness =  $0.038 \pm 0.013$  [.0015 ± .0005]  
 Tin-Lead Thickness =  $0.008 \pm 0.004$  [.0003 ± .0002]  
 Finishes other than Tin-Lead, See Appl. Spec. 114-13202

**Note:** All part numbers are RoHS compliant. Tin-Lead parts are RoHS compliant through exemption for lead in press-fit connectors.

### 3 Pair Vertical Header Assemblies

Column	Part Number	Dimension		Application Tooling*	Mates With
		A	B		
8	1934299-1	15.35 .604	13.30 .524	1-1901457-1	1934226-1
10	1934339-1	19.15 .754	17.10 .673	1-1901457-2	1934228-1
16	1934343-1	30.55 1.203	28.50 1.122	1-1901457-3	1934229-1

\* Reference Application Specification 114-13202.

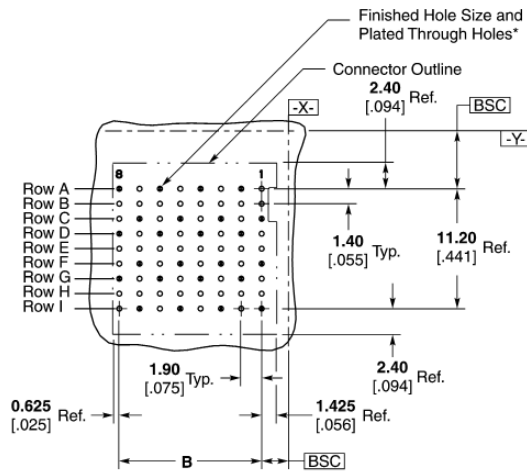
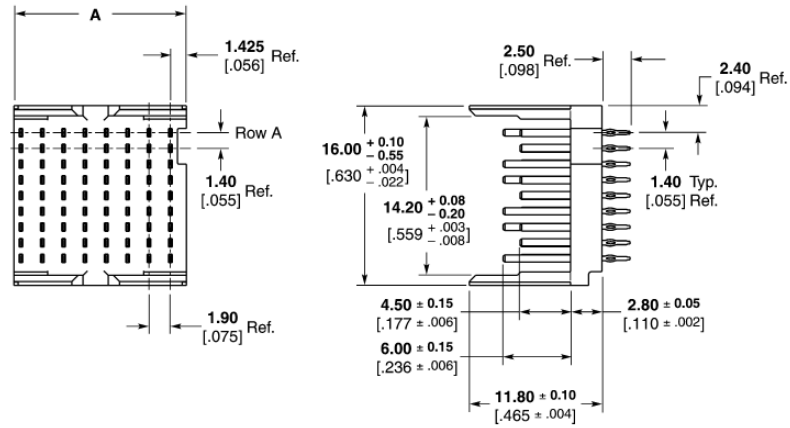

**Recommended PC Board Layout  
Component Side Shown**

**Note:** For additional information on pcb routing guidelines, reference the Z-PACK TinMan Connector Routing Guide Report #27GC001-1.

\* Finished Hole Diameter =  $0.46 \pm 0.05$  [.018 ± .002]  
 Drilled Hole Diameter =  $0.55 \pm 0.02$  [.022 ± .001]  
 Copper Thickness =  $0.038 \pm 0.013$  [.0015 ± .0005]  
 Tin-Lead Thickness =  $0.008 \pm 0.004$  [.0003 ± .0002]  
 Finishes other than Tin-Lead, See Appl. Spec. 114-13202

**Note:** All part numbers are RoHS compliant. Tin-Lead parts are RoHS compliant through exemption for lead in press-fit connectors.

### 3 Pair Vertical Header Assemblies — Left End Wall

Column	Part Number	Dimension		Application Tooling*	Mates With
		A	B		
8	1934300-1	16.30 .642	13.30 .524	1-1901457-1	1934226-1
10	1934340-1	20.10 .791	17.10 .673	1-1901457-2	1934228-1
16	1934344-1	31.50 1.240	28.50 1.122	1-1901457-3	1934229-1

\* Reference Application Specification 114-13202.

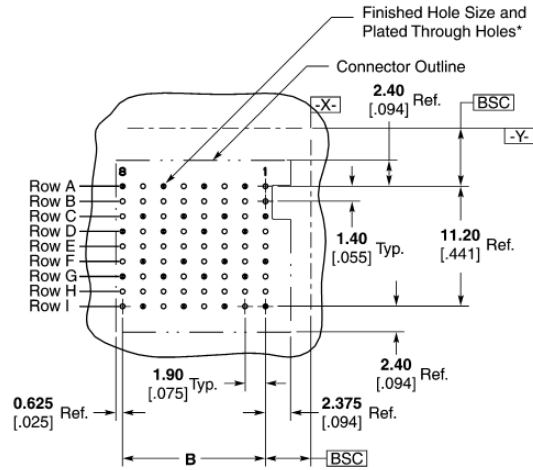
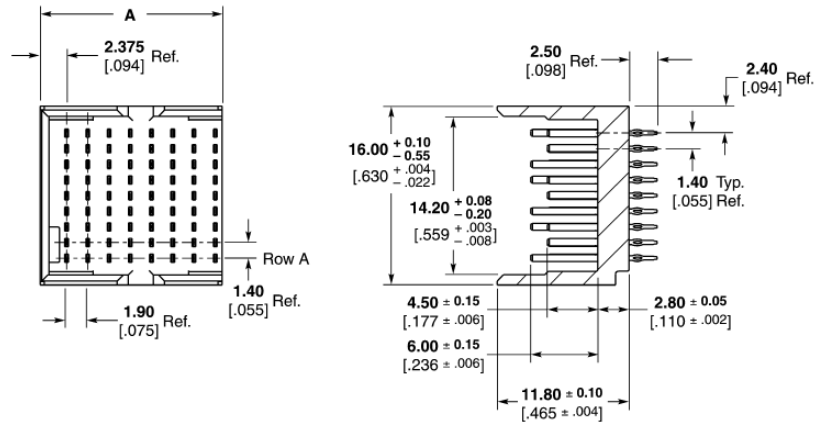

**Recommended PC Board Layout  
Component Side Shown**

**Note:** For additional information on pcb routing guidelines, reference the Z-PACK TinMan Connector Routing Guide Report #27GC001-1.

\* Finished Hole Diameter =  $0.46 \pm 0.05$  [.018 ± .002]  
 Drilled Hole Diameter =  $0.55 \pm 0.02$  [.022 ± .001]  
 Copper Thickness =  $0.038 \pm 0.013$  [.0015 ± .0005]  
 Tin-Lead Thickness =  $0.008 \pm 0.004$  [.0003 ± .0002]  
 Finishes other than Tin-Lead, See Appl. Spec. 114-13202

**Note:** All part numbers are RoHS compliant. Tin-Lead parts are RoHS compliant through exemption for lead in press-fit connectors.

### 3 Pair Vertical Header Assemblies — Right End Wall

Column	Part Number	Dimension		Application Tooling*	Mates With
		A	B		
8	1934301-1	17.00 .669	13.30 .524	1-1901457-1	1934226-1
10	1934341-1	20.08 .791	17.10 .673	1-1901457-2	1934228-1
16	1934345-1	32.20 1.268	28.50 1.122	1-1901457-3	1934229-1

\* Reference Application Specification 114-13202.

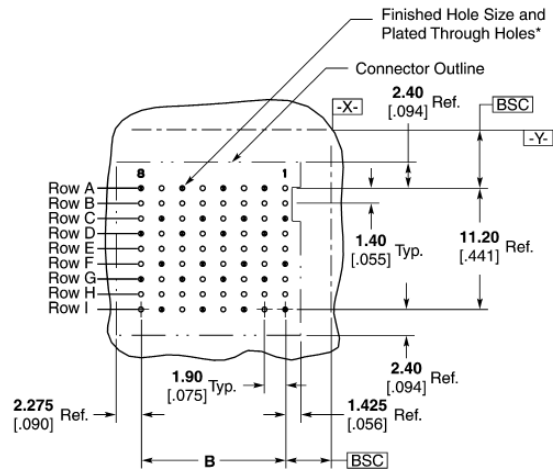
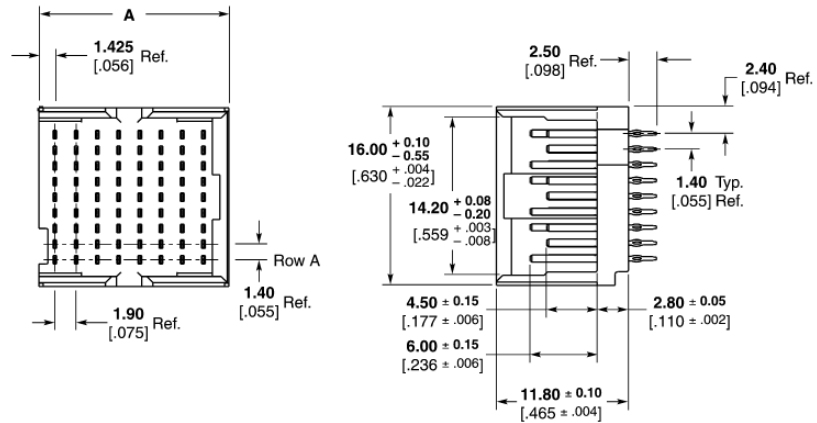

**Recommended PC Board Layout  
Component Side Shown**

**Note:** For additional information on pcb routing guidelines, reference the Z-PACK TinMan Connector Routing Guide Report #27GC001-1.

\* Finished Hole Diameter =  $0.46 \pm 0.05$  [.018 ± .002]  
 Drilled Hole Diameter =  $0.55 \pm 0.02$  [.022 ± .001]  
 Copper Thickness =  $0.038 \pm 0.013$  [.0015 ± .0005]  
 Tin-Lead Thickness =  $0.008 \pm 0.004$  [.0003 ± .0002]  
 Finishes other than Tin-Lead, See Appl. Spec. 114-13202

**Note:** All part numbers are RoHS compliant. Tin-Lead parts are RoHS compliant through exemption for lead in press-fit connectors.



### 3 Pair Vertical Header Assemblies — Double End Walls

Column	Part Number	Dimension		Application Tooling*	Mates With
		A	B		
8	1934302-1	17.95 .707	13.30 .524	1-1901457-1	1934226-1
10	1934342-1	21.75 .856	17.10 .673	1-1901457-2	1934228-1
16	1934346-1	33.15 1.305	28.50 1.122	1-1901457-3	1934229-1

\* Reference Application Specification 114-13202.

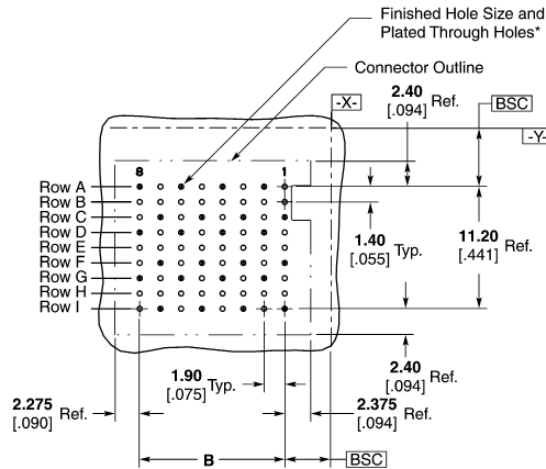
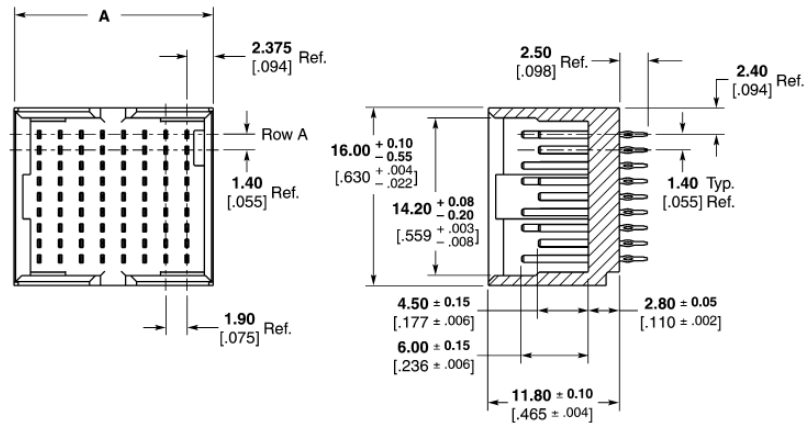

Recommended PC Board Layout  
Component Side Shown

**Note:** For additional information on pcb routing guidelines, reference the Z-PACK TinMan Connector Routing Guide Report #27GC001-1.

\* Finished Hole Diameter =  $0.46 \pm 0.05$  [ $0.018 \pm 0.002$ ]  
 Drilled Hole Diameter =  $0.55 \pm 0.02$  [ $0.022 \pm 0.001$ ]  
 Copper Thickness =  $0.038 \pm 0.013$  [ $0.0015 \pm 0.0005$ ]  
 Tin-Lead Thickness =  $0.008 \pm 0.004$  [ $0.0003 \pm 0.0002$ ]  
 Finishes other than Tin-Lead, See Appl. Spec. 114-13202

**Note:** All part numbers are RoHS compliant. Tin-Lead parts are RoHS compliant through exemption for lead in press-fit connectors.

### 5 Pair Right Angle Pin Header Assemblies

Column	Part Number	Dimension		Application Tooling	Mates With
		A	B		
8	1934349-1	15.35 .604	13.30 .524	*	1934218-1
16	1934347-1	30.55 1.203	28.50 1.122	*	1934221-1

\* Custom tooling not required. Utilizes flat-rock insertion tooling.  
Reference Application Specification 114-13202.

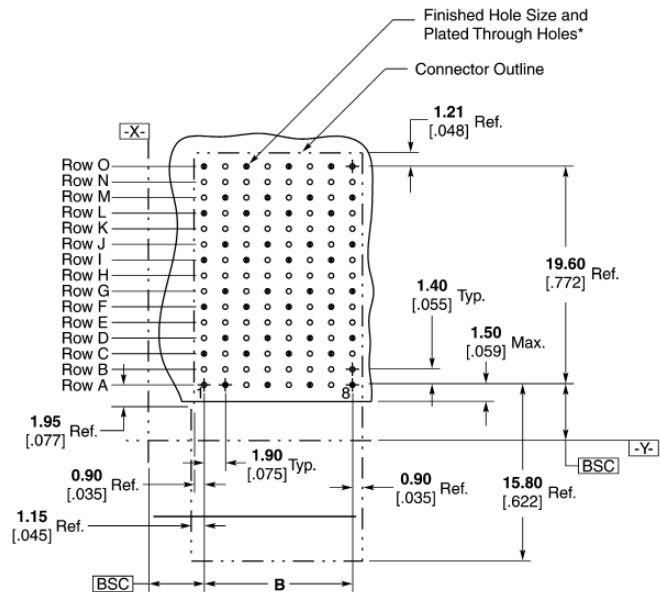
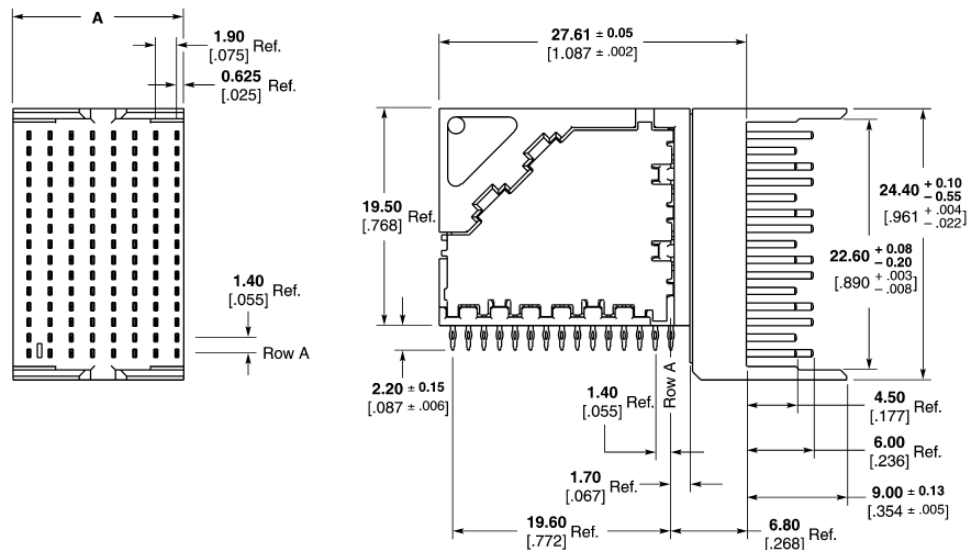

Recommended PC Board Layout  
Component Side Shown

**Note:** For additional information on pcb routing guidelines, reference the Z-PACK TinMan Connector Routing Guide Report #27GC001-1.

\* Finished Hole Diameter = 0.46 ± 0.05 [0.018 ± 0.002]  
Drilled Hole Diameter = 0.55 ± 0.02 [0.022 ± 0.001]  
Copper Thickness = 0.038 ± 0.013 [0.0015 ± 0.0005]  
Tin-Lead Thickness = 0.008 ± 0.004 [0.0003 ± 0.0002]  
Finishes other than Tin-Lead, See Appl. Spec. 114-13202

**Note:** All part numbers are RoHS compliant. Tin-Lead parts are RoHS compliant through exemption for lead in press-fit connectors.

## 5 Pair Right Angle Pin Header Assemblies — Double End Walls

1 Z-PACK TinMan High Speed, High Density Backplane Connector

Column	Part Number	Dimension		Application Tooling	Mates With
		A	B		
8	1934350-1	18.05 [.711]	13.30 .524	*	1934218-1
16	1934348-1	33.25 1.309	28.50 1.122	*	1934221-1

\* Custom tooling not required. Utilizes flat-rock insertion tooling.  
Reference Application Specification 114-13202.

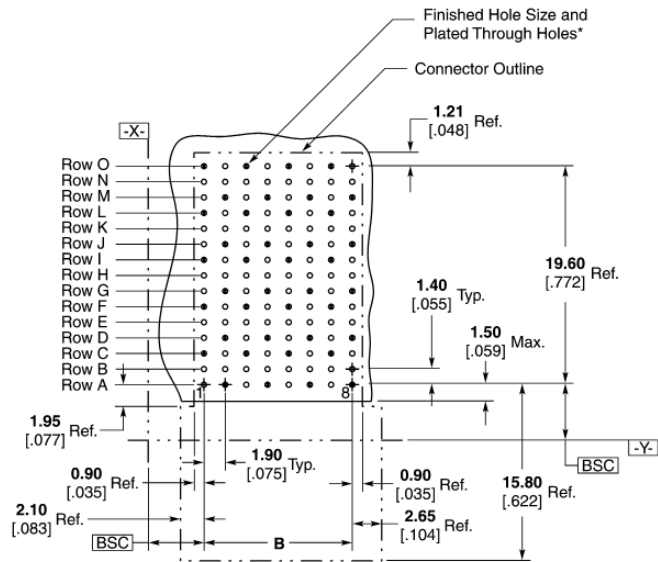
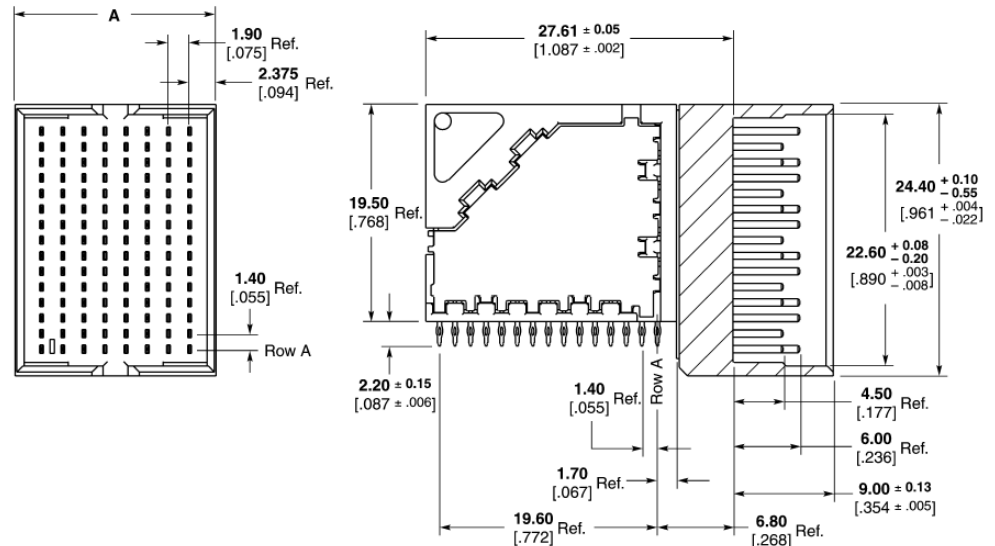

**Recommended PC Board Layout  
Component Side Shown**

**Note:** For additional information on pcb routing guidelines, reference the Z-PACK TinMan Connector Routing Guide Report #27GC001-1.

\* Finished Hole Diameter =  $0.46 \pm 0.05$  [.018 ± .002]  
 Drilled Hole Diameter =  $0.55 \pm 0.02$  [.022 ± .001]  
 Copper Thickness =  $0.038 \pm 0.013$  [.0015 ± .0005]  
 Tin-Lead Thickness =  $0.008 \pm 0.004$  [.0003 ± .0002]  
 Finishes other than Tin-Lead, See Appl. Spec. 114-13202

**Note:** All part numbers are RoHS compliant. Tin-Lead parts are RoHS compliant through exemption for lead in press-fit connectors.

### 4 Pair Right Angle Pin Header Assemblies

Column	Part Number	Dimension		Application Tooling	Mates With
		A	B		
8	1934353-1	15.35 .604	13.30 .524	*	1934222-1
16	1934351-1	30.55 1.203	28.50 1.122	*	1934225-1

\* Custom tooling not required. Utilizes flat-rock insertion tooling.  
Reference Application Specification 114-13202.

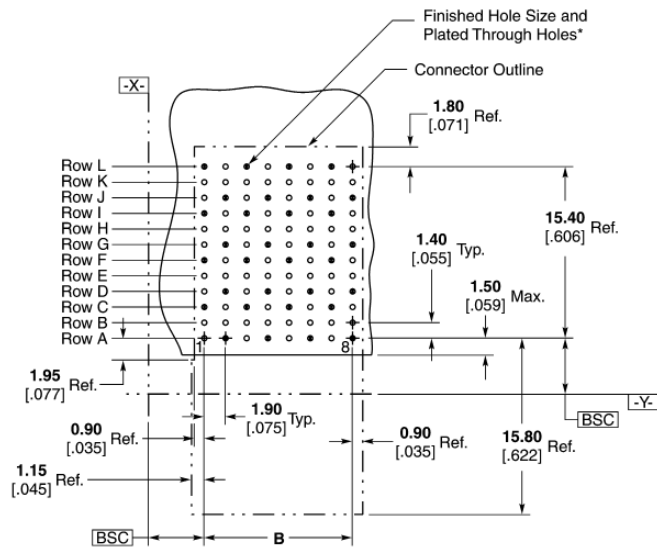
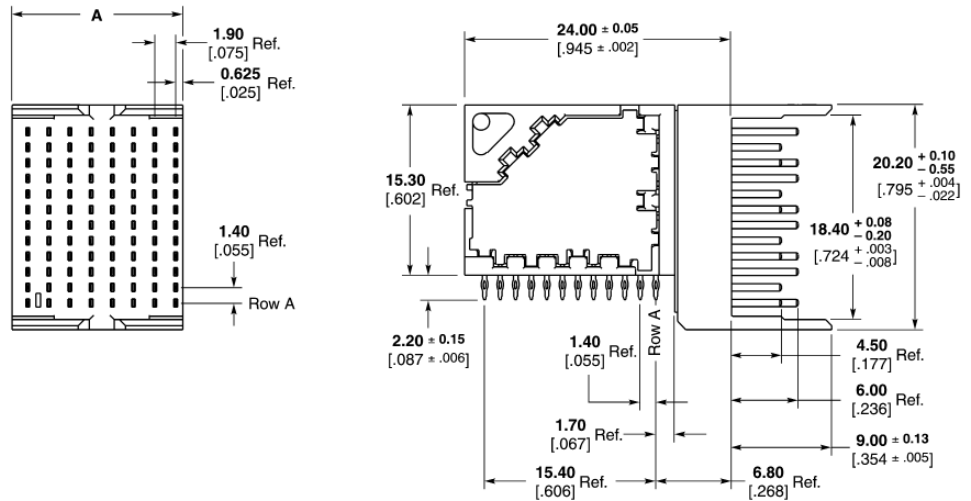

**Recommended PC Board Layout  
Component Side Shown**

**Note:** For additional information on pcb routing guidelines, reference the Z-PACK Tin-Mat Connector Routing Guide Report #27GC001-1.

\* Finished Hole Diameter =  $0.46 \pm 0.05$  [.018 ± .002]  
Drilled Hole Diameter =  $0.55 \pm 0.02$  [.022 ± .001]  
Copper Thickness =  $0.038 \pm 0.013$  [.0015 ± .0005]  
Tin-Lead Thickness =  $0.008 \pm 0.004$  [.0003 ± .0002]  
Finishes other than Tin-Lead, See Appl. Spec. 114-13202

**Note:** All part numbers are RoHS compliant. Tin-Lead parts are RoHS compliant through exemption for lead in press-fit connectors.

**4 Pair Right Angle Pin Header Assemblies — Double End Walls**

1 Z-PACK TinMan High Speed, High Density Backplane Connector

Column	Part Number	Dimension		Application Tooling	Mates With
		A	B		
8	1934354-1	18.05 .711	13.30 .524	*	1934222-1
16	1934352-1	33.25 1.309	28.50 1.122	*	1934225-1

\* Custom tooling not required. Utilizes flat-rock insertion tooling.  
Reference Application Specification 114-13202.

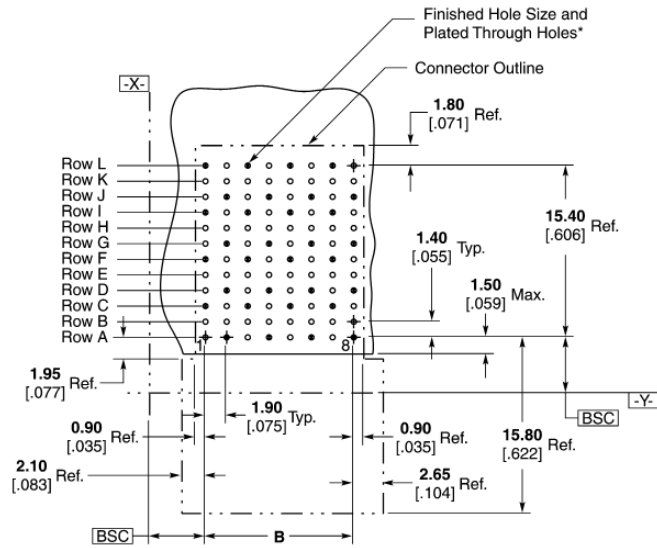
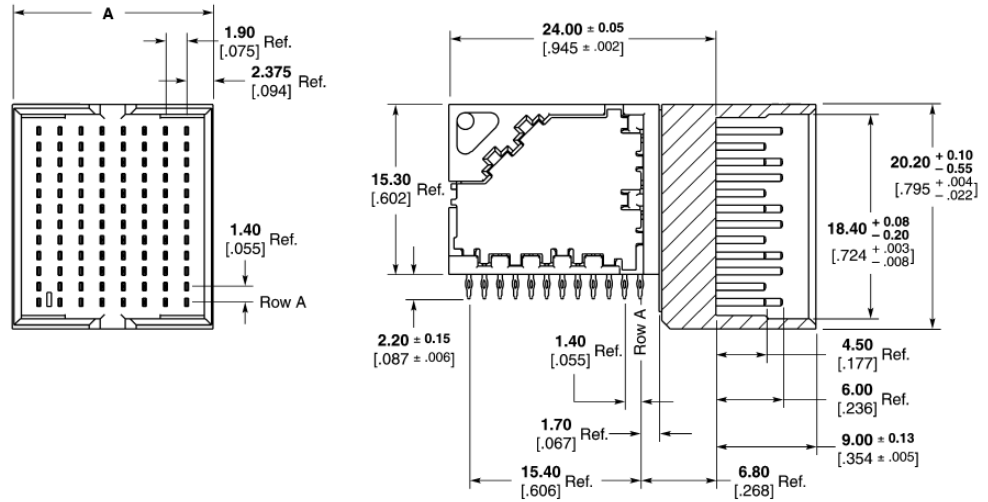

**Recommended PC Board Layout  
Component Side Shown**

**Note:** For additional information on pcb routing guidelines, reference the Z-PACK TinMan Connector Routing Guide Report #27GC001-1.

\* Finished Hole Diameter =  $0.46 \pm 0.05$  [.018 ± .002]  
 Drilled Hole Diameter =  $0.55 \pm 0.02$  [.022 ± .001]  
 Copper Thickness =  $0.038 \pm 0.013$  [.0015 ± .0005]  
 Tin-Lead Thickness =  $0.008 \pm 0.004$  [.0003 ± .0002]  
 Finishes other than Tin-Lead, See Appl. Spec. 114-13202

**Note:** All part numbers are RoHS compliant. Tin-Lead parts are RoHS compliant through exemption for lead in press-fit connectors.

### 3 Pair Right Angle Pin Header Assemblies

Column	Part Number	Dimension		Application Tooling	Mates With
		A	B		
8	1934359-1	15.35 .604	13.30 .524	*	1934226-1
10	1934357-1	19.15 .754	17.10 .673	*	1934228-1
16	1934355-1	30.55 1.203	28.50 1.122	*	1934229-1

\* Custom tooling not required. Utilizes flat-rock insertion tooling.  
Reference Application Specification 114-13202.

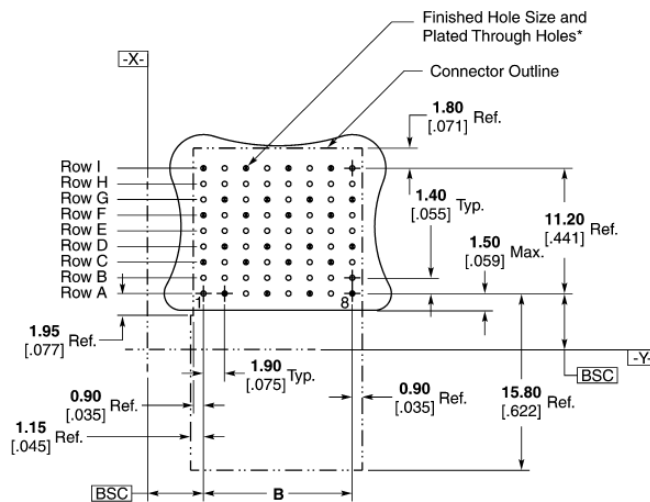
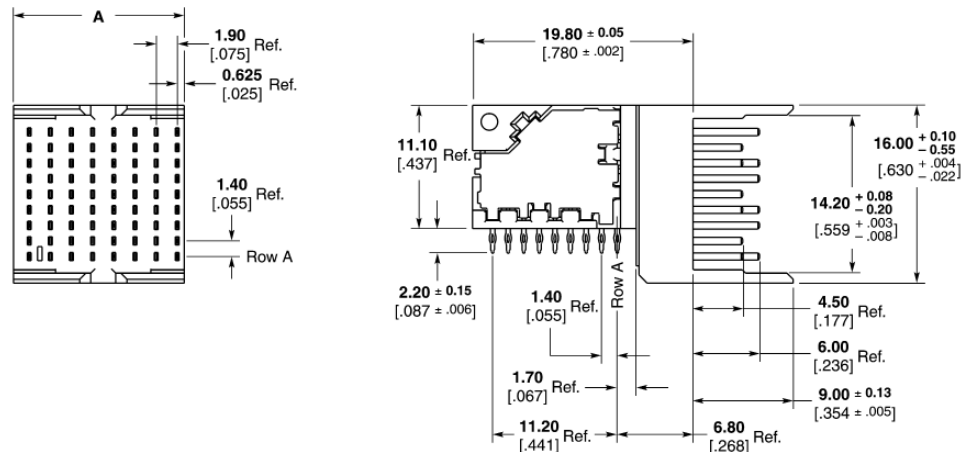

**Recommended PC Board Layout**  
**Component Side Shown**

**Note:** For additional information on pcb routing guidelines, reference the Z-PACK TinMan Connector Routing Guide Report #27GC001-1.

\* Finished Hole Diameter =  $0.46 \pm 0.05$  [.018 ± .002]  
Drilled Hole Diameter =  $0.55 \pm 0.02$  [.022 ± .001]  
Copper Thickness =  $0.038 \pm 0.013$  [.0015 ± .0005]  
Tin-Lead Thickness =  $0.008 \pm 0.004$  [.0003 ± .0002]  
Finishes other than Tin-Lead, See Appl. Spec. 114-13202

**Note:** All part numbers are RoHS compliant. Tin-Lead parts are RoHS compliant through exemption for lead in press-fit connectors.

### 3 Pair Right Angle Pin Header Assemblies — Double End Walls

1 Z-PACK TinMan High Speed, High Density Backplane Connector

Column	Part Number	Dimension		Application Tooling	Mates With
		A	B		
8	1934360-1	18.05 .711	13.30 .524	*	1934226-1
10	1934358-1	21.85 .860	17.10 .673	*	1934228-1
16	1934356-1	33.25 1.309	28.50 1.122	*	1934229-1

\* Custom tooling not required. Utilizes flat-rock insertion tooling.  
Reference Application Specification 114-13202.

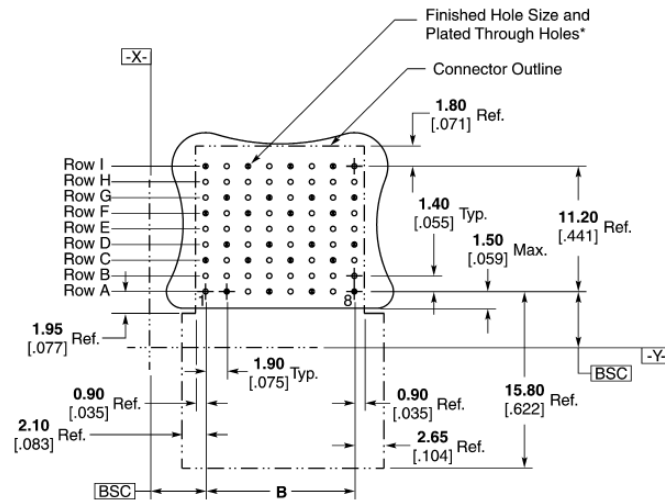
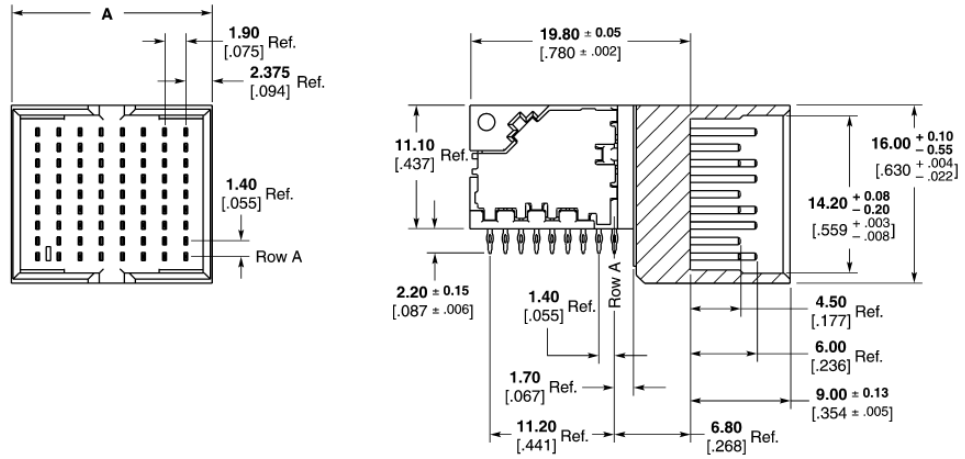

**Recommended PC Board Layout  
Component Side Shown**

**Note:** For additional information on pcb routing guidelines, reference the Z-PACK TinMan Connector Routing Guide Report #27GC001-1.

\* Finished Hole Diameter =  $0.46 \pm 0.05$  [.018 ± .002]  
Drilled Hole Diameter =  $0.55 \pm 0.02$  [.022 ± .001]  
Copper Thickness =  $0.038 \pm 0.013$  [.0015 ± .0005]  
Tin-Lead Thickness =  $0.008 \pm 0.004$  [.0003 ± .0002]  
Finishes other than Tin-Lead, See Appl. Spec. 114-13202

**Note:** All part numbers are RoHS compliant. Tin-Lead parts are RoHS compliant through exemption for lead in press-fit connectors.

## Z-PACK TinMan Midplane (Orthogonal) Connector Overview

### Product Facts

- Scalable to 25 Gbps
- 100 ohm impedance for differential pair configuration
- Very low noise
- Outstanding insertion loss through 2 connectors and vias
- Skewless differential pair in a 2-connector system
- Utilizes the same header and receptacle part on both sides of the midplane
- Compatible with standard Z-PACK TinMan connectors and accessories
- 4 pair x 4 pair and 6 pair x 6 pair modules available
- Reliable, redundant contact design on all contacts
- Reliable press-fit style termination to PCB
- RoHS compliant

### Applications

The Z-PACK TinMan midplane (orthogonal) connector is ideally designed for very demanding applications involving data rates in excess of 10 Gbps with many interconnections required. Such applications would include the following Telecom/Datacom equipment:

- Switches
- Servers
- Routers
- Storage

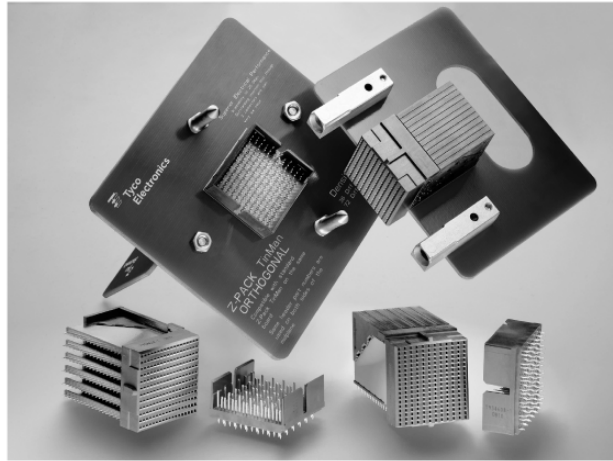

The Z-PACK TinMan midplane (orthogonal) connector is an extension of the Z-PACK TinMan connector product line, which includes perpendicular and coplanar interconnect solutions in 3 pair, 4 pair, and 5 pair versions.

This connector system is commonly referred to as an orthogonal connector system due to the orthogonal (perpendicular) orientation of the two system boards being connected on the front and rear side. It is built on the same technology and design approach as standard Z-PACK TinMan connectors with the same mating interface and lead-frame geometry.

Superior electrical performance is achieved for several reasons. The front board to

rear board connection through the midplane makes the plated through hole (PTH) part of the signal transmission path eliminating the detrimental effects of via stubs. This construction also eliminates the need to route all the high speed signal lines along the backplane minimizing signal loss and significantly improving signal throughput. The wide column spacing establishes a connector footprint with improved impedance and reduced electrical noise. The in-line footprint version also provides ease of trace routing with wide channels and a connector interface compatible with the orthogonal receptacle. This permits the use of the same daughtercard in both midplane and backplane configurations.

The benefits are not limited to just signal integrity performance. The thinner midplane with fewer layers and significantly less complex routing is inherently less expensive. With trace routing typically limited to power distribution, low speed lines and potentially very few high speed links, the board can be fabricated from a cost effective material without the need to utilize techniques such as counter-boring or back-drilling.

All of this permits the implementation of small to large scale full mesh interconnects with significantly reduced complexity at a lower cost and with improved signal integrity.

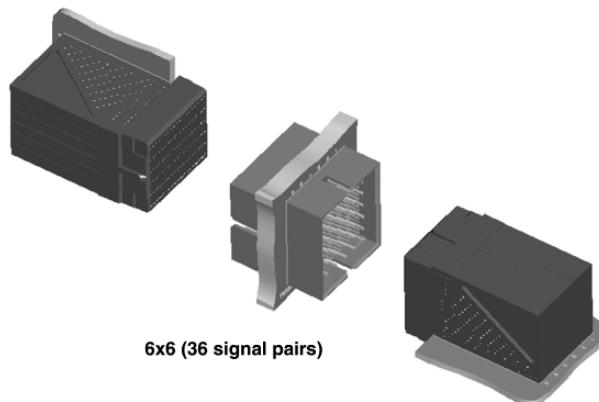

6x6 (36 signal pairs)

For additional information visit:  
<http://www.tycoelectronics.com/zpacktinman>



## Z-PACK TinMan Midplane (6 x 12 Orthogonal) Connector Overview

### Noise Table

- Maximum, multiple source crosstalk

### Technical Documents

Product Specification 108-2303

Application Specification 114-13202

Routing Guide Report #27GC002

### Material and Finish

**Signal Contact** — High Strength Copper Alloy

**Ground Contact** — High Strength Copper Alloy

**Housing** — Liquid Crystal Polymer, UL 94V-0 Rated

**Platings** — Telcordia compliant interface, Nickel underplate

**Compliant Pin Plating** — RoHS Compliant

### Ratings

**Temperature Range** — -65°C to +90°C

**Current Rating** — 0.5 A/contact @ < 30°C T-Rise

**Durability** — 200 cycles

**Dielectric Withstanding Voltage** — 560 VAC

**Operating Voltage** — 250 VAC max.

### Signal Integrity

**Characteristic Impedance** — Differential @ 100 ohms ±10%

**Crosstalk** — Multi-pair differential crosstalk: 1.0% @ 50ps

**Insertion Loss** — -2 dB @ 10 GHz

Pair	Total Peak
AB	1.2%
BC	N/A
DE	2.5%
EF	2.4%
GH	2.5%
HI	2.7%
JK	2.8%
KL	2.8%
MN	3.0%
NO	2.9%
PQ	2.3%
QR	1.4%

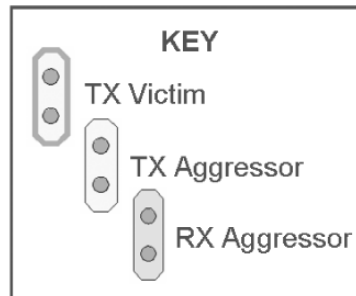
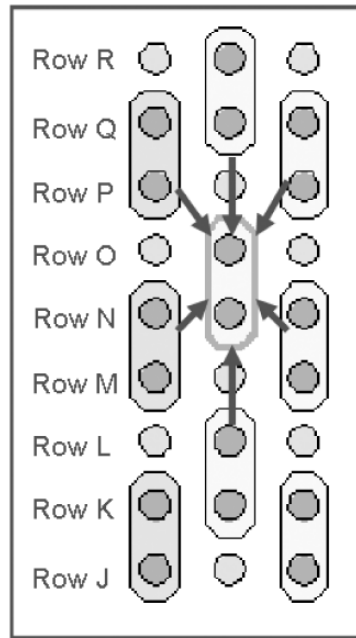

### Insertion Loss Plot

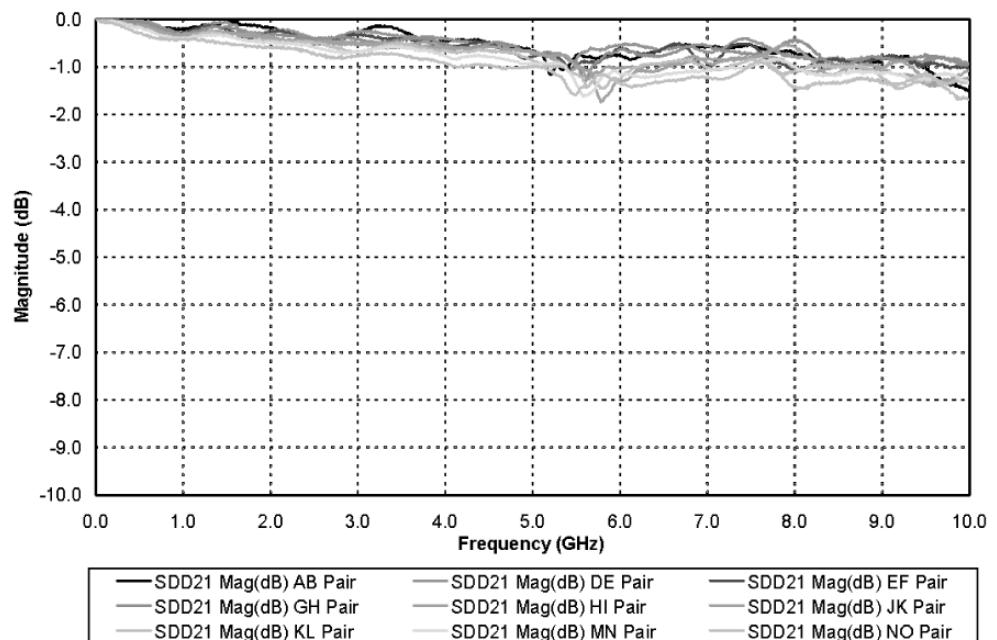

TELCORDIA is a trademark of Telcordia Technologies, Inc.

**Z-PACK TinMan Midplane (6 x 12 Orthogonal) Connector Overview** (Continued)

**Representative Eye Pattern**

- 10.0 Gbps data rate
- 2<sup>-1</sup> PRBS
- Unequalized Signal

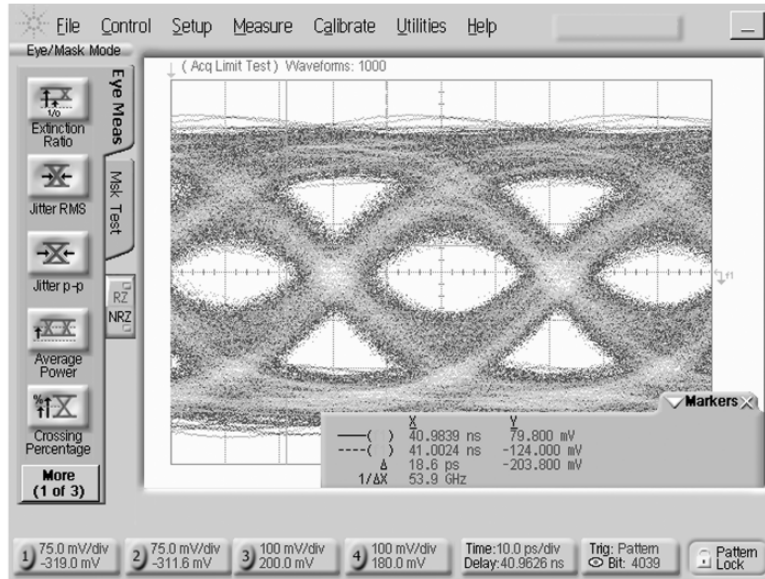

**Customer Connector Evaluation Kit**

- Connector characterization
- Available for loan — contact your local Tyco Electronics Sales Engineer
- Time and frequency domain testable
- Testable to 18+ GHz (25+ Gb/s)
- Multiple calibration options
- Convenient SMA interface

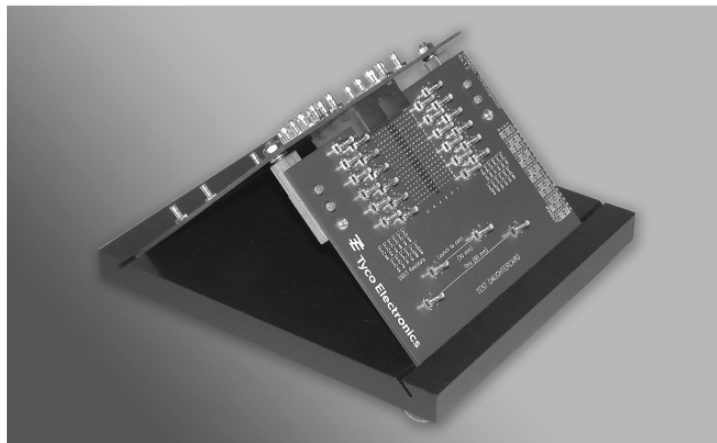

**Customer System Evaluation Kit**

- System characterization
- Available for loan — contact your local Tyco Electronics Sales Engineer
- Time and frequency domain testable
- Testable to 18+ GHz (25+ Gb/s)
- Multiple calibration options
- Convenient SMA interface

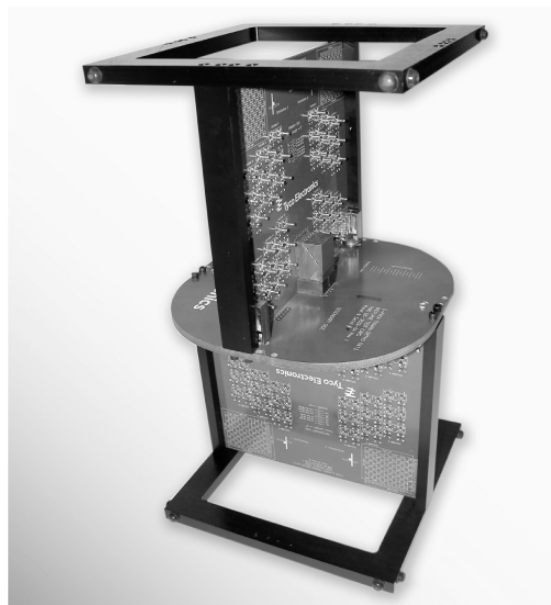

**Z-PACK TinMan Orthogonal 6 Pair Midplane Assemblies**

**6 Pair 12 Column  
Receptacle Assembly**

Part Number 1934633-1

Reference Application  
Specification  
114-13202

Mates with  
Part Number 1934607-1 and  
Part Number 1934608-1

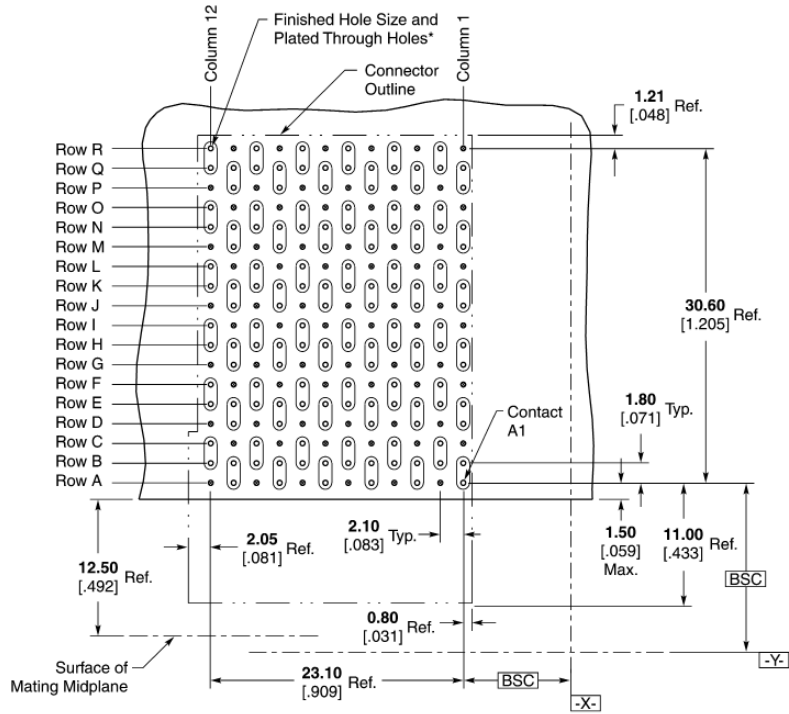
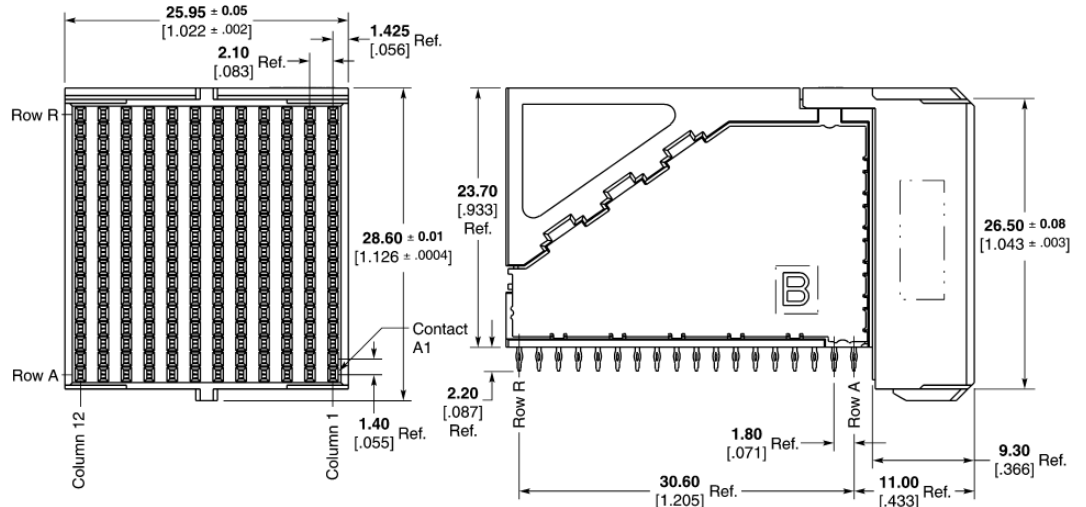

**Recommended PC Board Layout  
Component Side Shown**

**Note:** For additional information on pcb routing guidelines, reference the Z-PACK TinMan Connector Routing Guide Report #27GC001-1.

\* Finished Hole Diameter =  $0.46 \pm 0.05$  [0.018 ± .002]  
 Drilled Hole Diameter =  $0.55 \pm 0.02$  [0.022 ± .001]  
 Copper Thickness =  $0.038 \pm 0.013$  [0.0015 ± .0005]  
 Tin-Lead Thickness =  $0.008 \pm 0.004$  [0.0003 ± .0002]  
 Finishes other than Tin-Lead, See Appl. Spec. 114-13202

**Note:** All part numbers are RoHS compliant. Tin-Lead parts are RoHS compliant through exemption for lead in press-fit connectors.

**Z-PACK TinMan Orthogonal 6 Pair Midplane Assemblies (Continued)**

**6 Pair 6 Column Receptacle Assembly A**

Part Number 1934634-1

Reference Application Specification 114-13202

Mates with Part Number 1934609-1 and Part Number 1934610-1

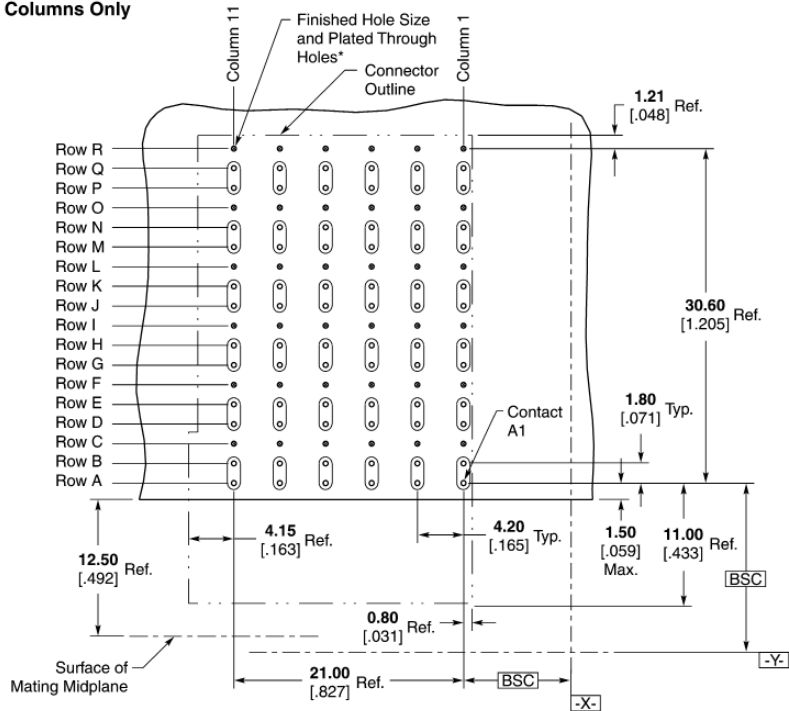
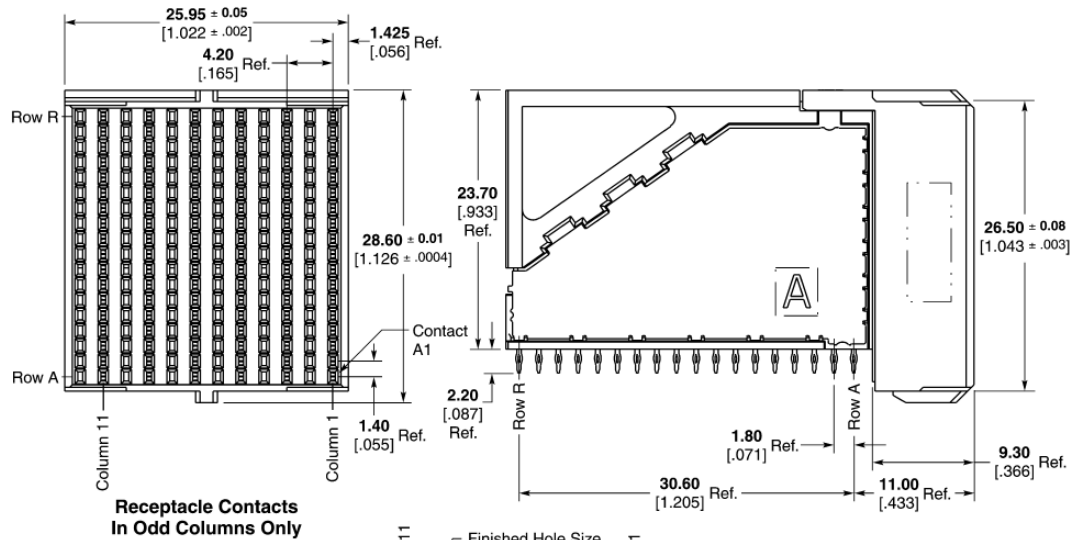

**Recommended PC Board Layout Component Side Shown**

**Note:** For additional information on pcb routing guidelines, reference the Z-PACK TinMan Connector Routing Guide Report #27GC001-1.

\* Finished Hole Diameter =  $0.46 \pm 0.05$  [.018 ± .002]  
 Drilled Hole Diameter =  $0.55 \pm 0.02$  [.022 ± .001]  
 Copper Thickness =  $0.038 \pm 0.013$  [.0015 ± .0005]  
 Tin-Lead Thickness =  $0.008 \pm 0.004$  [.0003 ± .0002]  
 Finishes other than Tin-Lead, See Appl. Spec. 114-13202

**Note:** All part numbers are RoHS compliant. Tin-Lead parts are RoHS compliant through exemption for lead in press-fit connectors.

**Z-PACK TinMan Orthogonal 6 Pair Midplane Assemblies (Continued)**

**6 Pair 6 Column Receptacle Assembly B**

Part Number 1934760-1

Reference Application Specification 114-13202

Mates with Part Number 1934609-1 and Part Number 1934610-1

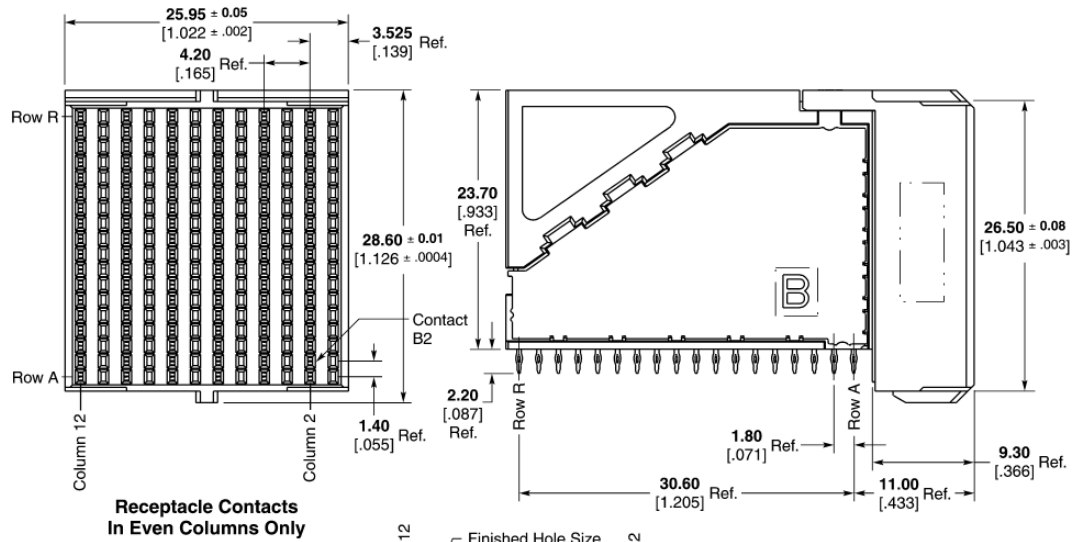

Receptacle Contacts In Even Columns Only

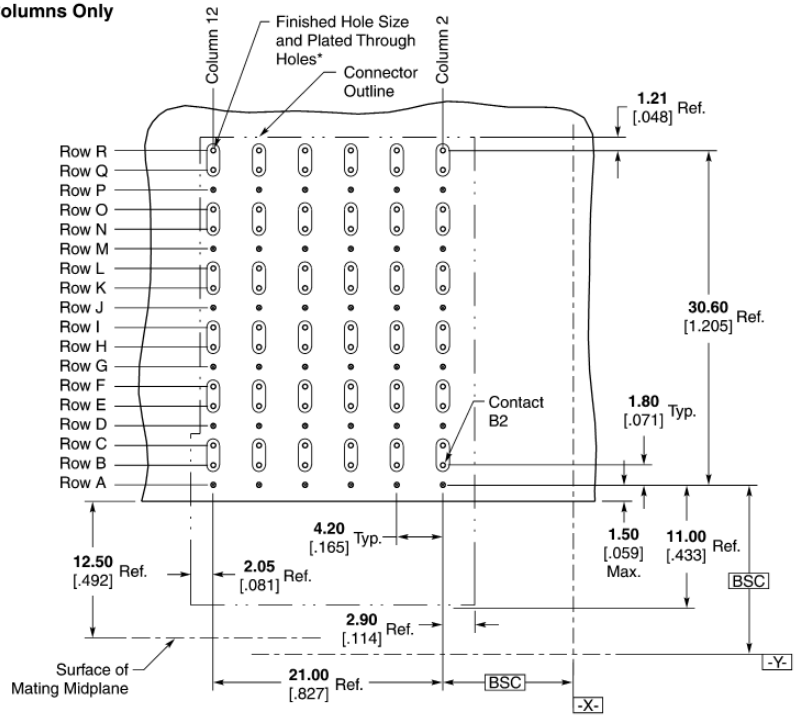

Recommended PC Board Layout Component Side Shown

**Note:** For additional information on pcb routing guidelines, reference the Z-PACK TinMan Connector Routing Guide Report #27GC001-1.

\* Finished Hole Diameter =  $0.46 \pm 0.05$  [0.018 ± .002]  
 Drilled Hole Diameter =  $0.55 \pm 0.02$  [0.022 ± .001]  
 Copper Thickness =  $0.038 \pm 0.013$  [0.0015 ± .0005]  
 Tin-Lead Thickness =  $0.008 \pm 0.004$  [0.0003 ± .0002]  
 Finishes other than Tin-Lead, See Appl. Spec. 114-13202

**Note:** All part numbers are RoHS compliant. Tin-Lead parts are RoHS compliant through exemption for lead in press-fit connectors.

**Z-PACK TinMan Orthogonal 6 Pair Midplane Assemblies (Continued)**

**6 Pair 12 Column  
Double Wall  
Header Assembly**  
Part Number 1934608-1  
Reference Application  
Specification  
114-13202  
Mates with  
Part Number 1934633-1

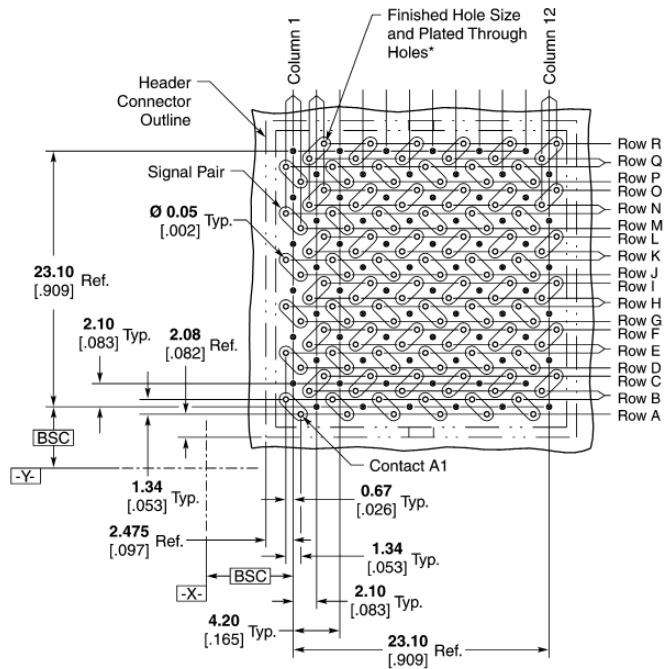
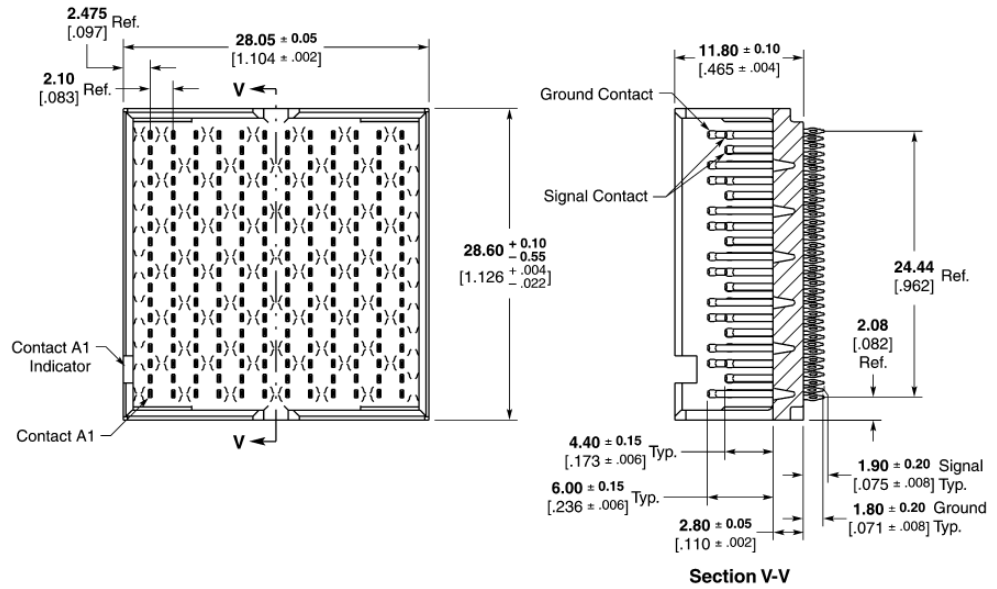

**Recommended PC Board Layout  
Component Side Shown**

**Note:** For additional information on pcb routing guidelines, reference the Z-PACK TinMan Connector Routing Guide Report #27GC001-1.

\* Finished Hole Diameter =  $0.46 \pm 0.05$  [0.018 ± .002]  
 Drilled Hole Diameter =  $0.55 \pm 0.02$  [0.022 ± .001]  
 Copper Thickness =  $0.038 \pm 0.013$  [0.0015 ± .0005]  
 Tin-Lead Thickness =  $0.008 \pm 0.004$  [0.0003 ± .0002]  
 Finishes other than Tin-Lead, See Appl. Spec. 114-13202

**Note:** All part numbers are RoHS compliant. Tin-Lead parts are RoHS compliant through exemption for lead in press-fit connectors.

**Z-PACK TinMan Orthogonal 6 Pair Midplane Assemblies (Continued)**

**6 Pair 12 Column  
Open Ended  
Header Assembly**  
Part Number 1934607-1  
Reference Application  
Specification  
114-13202  
Mates with  
Part Number 1934633-1

1 Z-PACK TinMan High Speed, High Density Backplane Connector

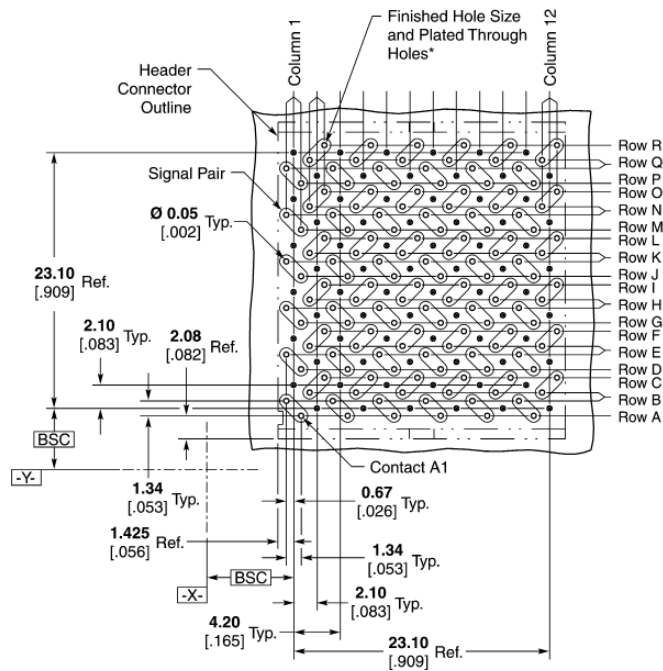
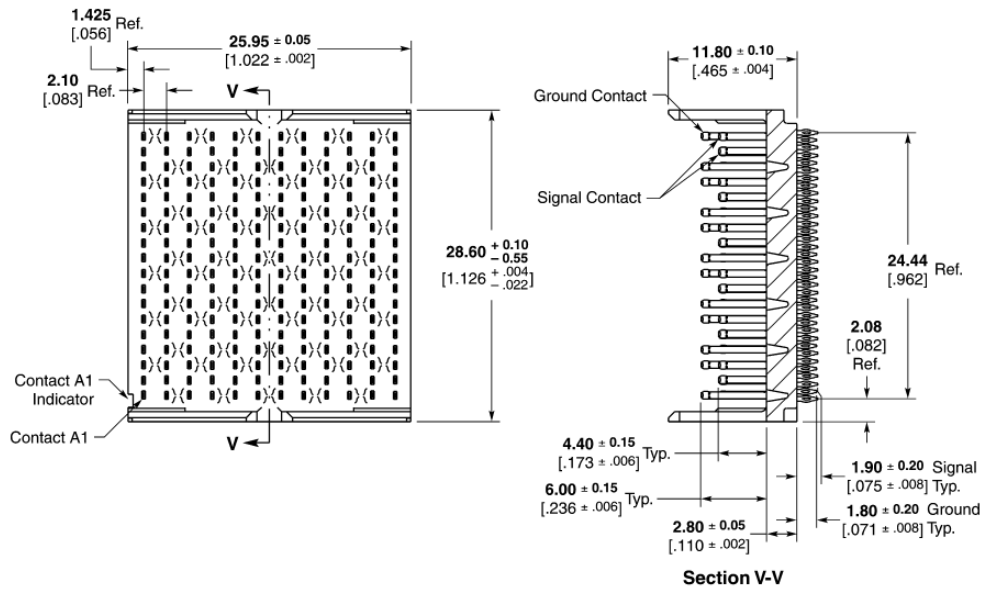

**Recommended PC Board Layout  
Component Side Shown**

**Note:** For additional information on pcb routing guidelines, reference the Z-PACK TinMan Connector Routing Guide Report #27GC001-1.

\* Finished Hole Diameter =  $0.46 \pm 0.05$  [.018 ± .002]  
 Drilled Hole Diameter =  $0.55 \pm 0.02$  [.022 ± .001]  
 Copper Thickness =  $0.038 \pm 0.013$  [.0015 ± .0005]  
 Tin-Lead Thickness =  $0.008 \pm 0.004$  [.0003 ± .0002]  
 Finishes other than Tin-Lead, See Appl. Spec. 114-13202

**Note:** All part numbers are RoHS compliant. Tin-Lead parts are RoHS compliant through exemption for lead in press-fit connectors.

**Z-PACK TinMan Orthogonal 6 Pair Midplane Assemblies (Continued)**

**6 Pair 6 Column  
Double Wall  
Header Assembly**

**Part Number 1934610-1**

**Reference Application  
Specification  
114-13202**

**Mates with  
Part Number 1934634-1 and  
Part Number 1934760-1**

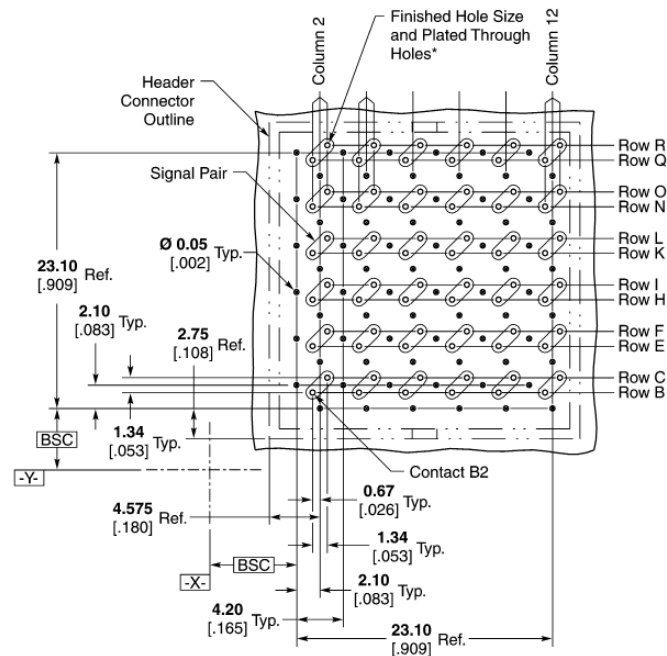
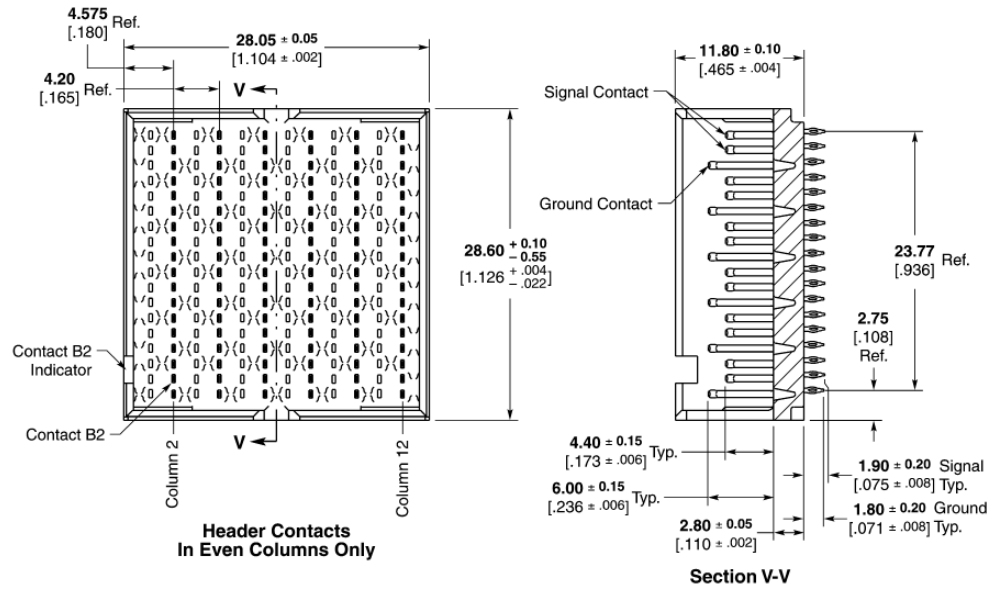

**Note:** For additional information on pcb routing guidelines, reference the Z-PACK TinMan Connector Routing Guide Report #27GC001-1.

\* Finished Hole Diameter =  $0.46 \pm 0.05$  [.018 ± .002]  
 Drilled Hole Diameter =  $0.55 \pm 0.02$  [.022 ± .001]  
 Copper Thickness =  $0.038 \pm 0.013$  [.0015 ± .0005]  
 Tin-Lead Thickness =  $0.008 \pm 0.004$  [.0003 ± .0002]  
 Finishes other than Tin-Lead, See Appl. Spec. 114-13202

**Note:** All part numbers are RoHS compliant. Tin-Lead parts are RoHS compliant through exemption for lead in press-fit connectors.



**Z-PACK TinMan Orthogonal 6 Pair Midplane Assemblies (Continued)**

**6 Pair 6 Column  
Open Ended  
Header Assembly**

**Part Number 1934609-1**

**Reference Application  
Specification  
114-13202**

**Mates with  
Part Number 1934634-1 and  
Part Number 1934760-1**

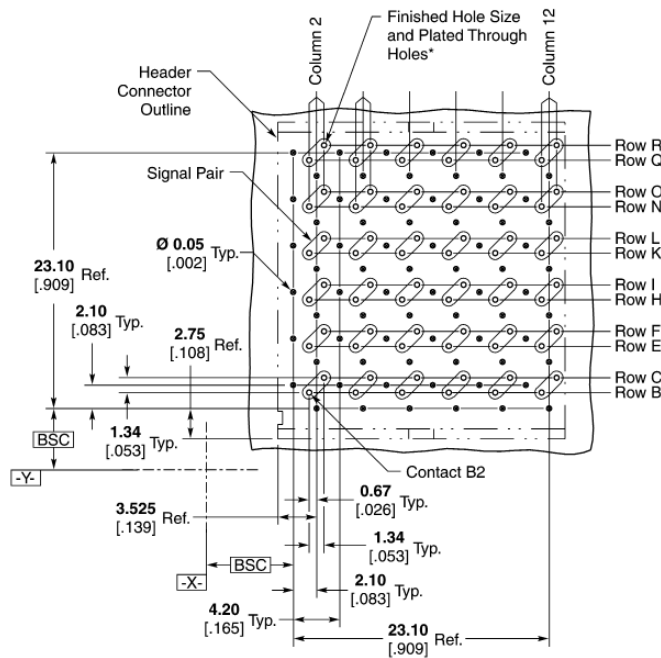
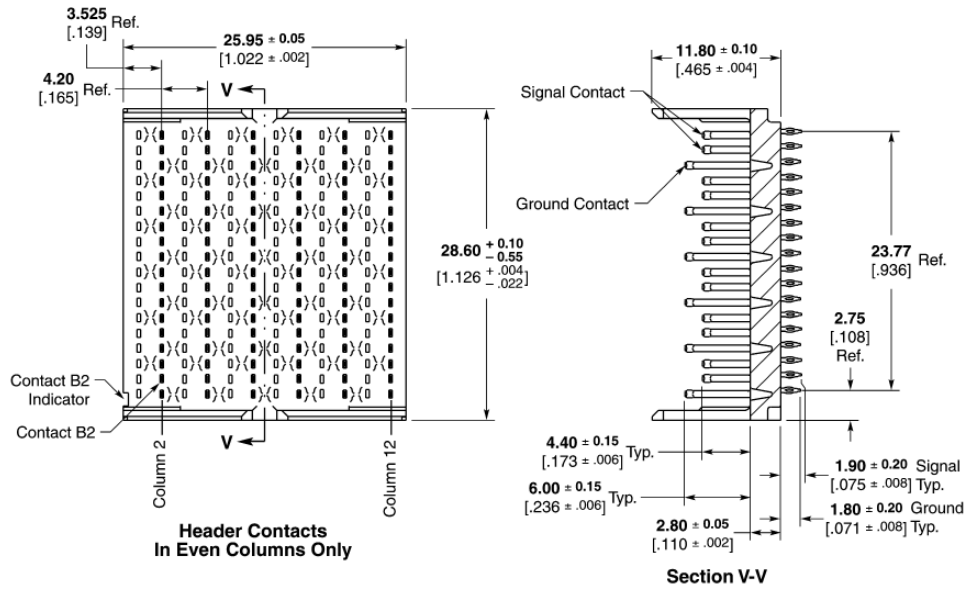

**Recommended PC Board Layout  
Component Side Shown**

**Note:** For additional information on pcb routing guidelines, reference the Z-PACK TinMan Connector Routing Guide Report #27GC001-1.

\* Finished Hole Diameter =  $0.46 \pm 0.05$  [.018 ± .002]  
 Drilled Hole Diameter =  $0.55 \pm 0.02$  [.022 ± .001]  
 Copper Thickness =  $0.038 \pm 0.013$  [.0015 ± .0005]  
 Tin-Lead Thickness =  $0.008 \pm 0.004$  [.0003 ± .0002]  
 Finishes other than Tin-Lead, See Appl. Spec. 114-13202

**Note:** All part numbers are RoHS compliant. Tin-Lead parts are RoHS compliant through exemption for lead in press-fit connectors.

**Z-PACK TinMan Product Mating Sequence Chart**



Product Family	Dim. C	Dim. A Fully Mated	Contact	Dim B.		Fully Mated Wipe Length
				Reliable Mate	First Mate Last Break	
Z-PACK HM-Zd Product	1.50 .059	12.50 .492	Ground Shield	16.78 [.661]	17.55 [.691]	4.28 [.169]
			Signal Level 2	15.41 [.607]	15.85 [.624]	2.91 [.115]
			Signal Level 1	13.91 [.548]	14.35 [.565]	1.41 [.056]
Z-PACK HM-Zd Guide Hardware	3.00 .118	12.50 .492	24.0 mm Pin	27.50 [1.083]	33.40 [1.315]	N/A
			22.2 mm Pin	25.70 [1.012]	31.60 [1.244]	N/A
			Key Blocking Point	N/A	22.03 [.867]	N/A
<b>Z-PACK TinMan Product</b>	1.50 .059	12.50 .492	Ground Pins	16.44 [.647]	17.13 [.674]	3.94 [.155]
			Signal Level 2	14.94 [.588]	15.63 [.615]	2.44 [.096]
			Signal Level 1	N/A	N/A	N/A
Z-PACK 2mm HM Product	1.50 .059	12.50 .492	Signal Level 3	18.27 [.719]	18.84 [.742]	5.77 [.227]
			Signal Level 2	16.77 [.660]	17.34 [.683]	4.27 [.168]
			Signal Level 1	15.27 [.601]	15.84 [.624]	2.77 [.109]
MULTIGIG RT T1 Product	2.50 .098	12.50 .492	Ground	18.00 [.709]	—	5.50 [.217]
			Signal Level 3	18.00 [.709]	—	5.50 [.217]
			Signal Level 2	16.50 [.650]	—	4.00 [.157]
			Signal Level 1	15.00 [.591]	—	2.50 [.098]
MULTIGIG RT T2 Product	2.25 .089	12.50 .492	Ground	18.00 [.709]	—	5.50 [.217]
			Signal Level 3	18.00 [.709]	—	5.50 [.217]
			Signal Level 2	16.50 [.650]	—	4.00 [.157]
MULTIGIG RT Power Module	5.50 .217	12.50 .492	Power Level 3	23.75 [.935]	—	11.25 [.443]
			Power Level 2	22.25 [.876]	—	9.75 [.384]
			Power Level 1	20.75 [.817]	—	8.25 [.325]
MULTIGIG RT Guide Hardware	N/A	12.50 .492	Guide Pin Key	33.25 [1.309]	N/A	20.75 [.817]
			Guide ESD Contact	30.75 [1.211]	—	18.25 [.719]
Z-PACK HS3 Product	1.50 .059	12.50 .492	Ground	17.08 [.672]	17.60 [.693]	4.78 [.188]
			Signal Level 2	16.05 [.632]	16.47 [.648]	3.75 [.148]
			Signal Level 1	14.55 [.573]	14.97 [.589]	2.25 [.089]
UPM	3.50 .138	12.50 .492	Power Level 3	20.25 [.797]	20.95 [.825]	8.10 [.319]
			Power Level 2	18.65 [.734]	19.35 [.762]	6.50 [.256]
			Power Level 1	17.03 [.670]	17.73 [.698]	4.88 [.192]
UPM Guide Hardware	5.75 .226	12.50 .492	Guide Pin Key	31.39 [1.236]	36.16 [1.424]	N/A
			Keyed Guide Pin	31.39 [1.236]	36.16 [1.424]	N/A
			Keyed Guide Pin	35.23 [1.387]	40.00 [1.575]	N/A
MULTI-BEAM XL Right Angle Header to Vertical Receptacle	5.08 .200	14.73 .580	PreMate Power — Level 1	—	16.84 [.663]	5.61 [.221] Min.
			PostMate Power — Level 2	—	17.81 [.701]	4.34 [.171] Min.
			PreMate Signal — Level 2	—	18.26 [.719]	3.81 [.150] Min.
			PostMate Signal — Level 3	—	19.53 [.769]	2.54 [.100] Min.
MULTI-BEAM XL Right Angle Receptacle to Vertical Header	3.81 .150	13.21 .520	PreMate Power — Level 1	—	15.32 [.603]	5.61 [.221] Min.
			PostMate Power — Level 2	—	16.28 [.641]	4.34 [.171] Min.
			PreMate Signal — Level 2	—	16.74 [.659]	3.81 [.150] Min.
			PostMate Signal — Level 3	—	18.01 [.709]	2.54 [.100] Min.

**Table of Contents**

**Z-PACK Slim UHD Connector** . . . . . 47-54  
 Product Line Overview . . . . . 48  
 Connector Concept . . . . . 49  
 Flexibility . . . . . 49  
 Upgradeability . . . . . 50  
 Connector Footprint . . . . . 50  
 Typical Electrical Properties . . . . . 51  
 Female and Male Connectors . . . . . 52  
 Right-Angle Male (RAM) Connector . . . . . 53  
 Power Connector . . . . . 53  
 Guide Pins and Guide Module . . . . . 54

**2**  
Z-PACK Slim UHD Connector

## Z-PACK Slim UHD Connectors

### Product Facts

- Density of 55 pins/cm<sup>2</sup>
- Fits +13 mm slot pitches
- 20+ Gbps scalable signal speed
- Complete end-to-end stackable
- Press-fit termination technology
- Different pin assignments possible
- Post/Premating possible
- Integrated polarization & guiding

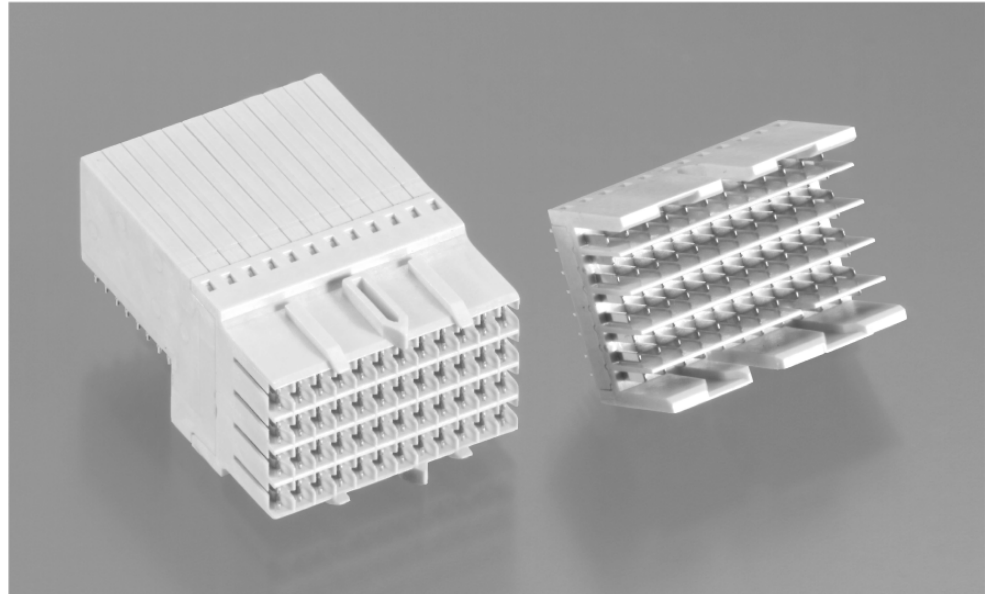

Z-PACK Slim (low profile) UHD (Ultra High Density) is a flexible and upgradeable connector system designed to fit 15 mm (0.6 inch) slot pitch applications.

The Z-PACK Slim UHD connector has an extremely high contact density combined with excellent high speed signal performance.

For more Information:  
<http://www.zpackuhd.com>

### Applications

- Telecom Equipment
- Switches
- Routers
- Servers, etc.



Компания «ЭлектроПласт» предлагает заключение долгосрочных отношений при поставках импортных электронных компонентов на взаимовыгодных условиях!

Наши преимущества:

- Оперативные поставки широкого спектра электронных компонентов отечественного и импортного производства напрямую от производителей и с крупнейших мировых складов;
- Поставка более 17-ти миллионов наименований электронных компонентов;
- Поставка сложных, дефицитных, либо снятых с производства позиций;
- Оперативные сроки поставки под заказ (от 5 рабочих дней);
- Экспресс доставка в любую точку России;
- Техническая поддержка проекта, помощь в подборе аналогов, поставка прототипов;
- Система менеджмента качества сертифицирована по Международному стандарту ISO 9001;
- Лицензия ФСБ на осуществление работ с использованием сведений, составляющих государственную тайну;
- Поставка специализированных компонентов (Xilinx, Altera, Analog Devices, Intersil, Interpoint, Microsemi, Aeroflex, Peregrine, Syfer, Eurofarad, Texas Instrument, Miteq, Cobham, E2V, MA-COM, Hittite, Mini-Circuits, General Dynamics и др.);

Помимо этого, одним из направлений компании «ЭлектроПласт» является направление «Источники питания». Мы предлагаем Вам помощь Конструкторского отдела:

- Подбор оптимального решения, техническое обоснование при выборе компонента;
- Подбор аналогов;
- Консультации по применению компонента;
- Поставка образцов и прототипов;
- Техническая поддержка проекта;
- Защита от снятия компонента с производства.



#### Как с нами связаться

**Телефон:** 8 (812) 309 58 32 (многоканальный)

**Факс:** 8 (812) 320-02-42

**Электронная почта:** [org@eplast1.ru](mailto:org@eplast1.ru)

**Адрес:** 198099, г. Санкт-Петербург, ул. Калинина, дом 2, корпус 4, литера А.