



Temperature protection devices

Chip NTC thermistor

Commercial grade

NTCG series

NTCG 0603 JIS 0603 [EIA 0201]

NTCG 1005 JIS 1005 [EIA 0402]

NTCG 1608 JIS 1608 [EIA 0603]

NTCG 2012 JIS 2012 [EIA 0805]

REMINDERS FOR USING THESE PRODUCTS

Before using these products, be sure to request the delivery specifications.

SAFETY REMINDERS

Please pay sufficient attention to the warnings for safe designing when using this products.

 **REMINDERS**

Incorrect usage may lead to destroyed NTC thermistors and damages or malfunctions with the devices used.

- Please use them within the ranges of the ratings and performance provided in the catalog and delivery specifications upon confirming the environments where they are to be used and installed.
- Do not use them outside the operating temperature range.
- Do not use them with the ratings or maximum permissible power levels exceeded.
- Do not quickly apply 5mW or more of load with the constant-voltage power supply in the NTC thermistors as this may lead to staying in thermal runaway mode or the red-shortening of chips.
- Please be cautious of the applied voltage in thermistors as instruments may malfunction with the lowering of resistance due to self heating.
- With instruments that consumers can touch the thermistors with their hands, please carefully warn them not to touch the thermistors.
- Store them in locations where the temperature is 10°C to +40°C and the relative humidity is 75% or below, avoid environments where there are sudden changes in temperatures, direct sunlight, corrosive gas, grit, or dust, and keep them packed in a manner where no loading stress is applied in order to avoid deterioration and damage. (please use them within six months.)
- When sealing thermistors, please do so upon first considering the type, quantity, hardening conditions, and adhesiveness of the sealing material and confirming its reliability.
- Avoid powerful vibrations, impact (such as by dropping), pressure, etc. on thermistors that exceed the prescribed levels.
- Do not use them for long periods of time in environments with a relative humidity of over 85%. (this excludes cases where countermeasures have been taken.)
- Do not use them in the following environments. (this excludes cases where countermeasures have been taken.)
 - Corrosive gases (Cl₂, NH₃, SO_x, NO_x, etc.)
 - Environments with highly conductive substances (electrolytes, water, saltwater, etc.)
 - Environments with acid, alkali, or organic solvents
 - Dusty areas
- Please observe the following precautions when attaching them to substrates as failure to do so may result in destruction or malfunction.
 - Do not let the substrates get warped or twisted at any time during the soldering.
 - The landing size must be even on both the left and right sides.
 - Do not use items that have been dropped or detached.
 - Do not allow the adherence of more solder than needed.
- Reflow mounting is recommended with NTC thermistors, and not flow (dip) mounting.
- Attaching or making corrections with a soldering iron is not recommended as it can lead to troubles such as significant distorting due to thermal shock or cracking. If a soldering iron must be used, it should be 20W or below with the temperature of the tip at 350°C or below, and at a maximum of 5 seconds of soldering time. Also, do not let the tip of the soldering iron come in direct contact with the chips.
- Please use a substance such as resin that does not generate hydrogen (H₂) when forming insulation film over chips.
- Please contact our sales offices when considering the use of the products listed on this catalog for applications, whose performance and/or quality require a more stringent level of safety or reliability, or whose failure, malfunction or trouble could cause serious damage to society, person or property ('specific uses' such as automobiles, airplanes, medical instruments, nuclear devices, etc.) as well as when considering the use for applications that exceed the range and conditions of this catalog.

Please note that we are not responsible for any damages or losses incurred resulting from the use of these products that exceeds the range and conditions of this catalog or specific uses.

Please take appropriate measures such as acquiring protective circuits and devices that meet the uses, applications, and conditions of the instruments and keeping backup circuits.

NTC thermistors

Commercial grade

Product compatible with RoHS directive
Compatible with lead-free solders

Overview of the NTCG series

CHARACTERISTICS OF NTC THERMISTORS

NTC(Negative Temperature Coefficient) thermistors are manufactured from sintered metal oxides. Each thermistor consists of a combination of two to four of the following materials: manganese, nickel, cobalt and copper. NTC thermistors are semiconductor resistors that exhibit decreasing resistance characteristics with increasing temperature. TDK thermistors have low thermal time constants which result in extremely high rates of resistance change to accurately track the temperature.

FEATURES OF NTCG SERIES

- 0603 to 2012mm wide lineup
- 125°C
- UL1434 acquisition (File No.E250289)

Fig.1 R-T Curve : 10kohm@25°C



Fig.2 Internal structure of the multilayer chip thermistors

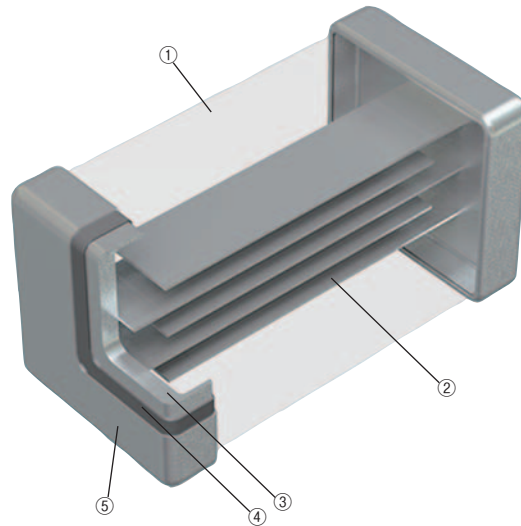

No.	Name
(1)	Semiconductor ceramics
(2)	Internal electrode(Pd)
(3)	Ag
(4)	Terminal electrode Ni
(5)	Sn

○ RoHS Directive Compliant Product: See the following for more details. <https://product.tdk.com/info/en/environment/rohs/index.html>

⚠ Please be sure to request delivery specifications that provide further details on the features and specifications of the products for proper and safe use. Please note that the contents may change without any prior notice due to reasons such as upgrading.

NTC thermistors

Commercial grade

Product compatible with RoHS directive
Compatible with lead-free solders

Overview of the NTCG series

APPLICATIONS

Smart phones



Battery



Wireless charger

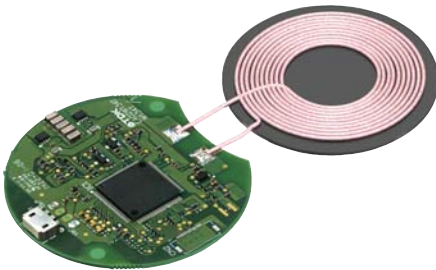

LED

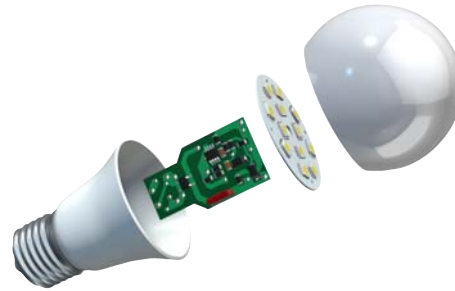

COMMERCIAL GRADE

Type	Dimensions Code JIS[EIA]	Use circuit example	Various-circuit temperature compensated circuit			PA, PMIC
			Circuit example	Target	Vout	Vout
			1kΩ	22kΩ	68kΩ	10kΩ
		Resistance(R25)				
		B constant (B25/85)	3100K to 4100K	3435K to 4550K	4000K to 4550K	3435K to 4100K
General	0603 [0201]		N/A	NTCG063JF223HTBX	NTCG064EF683FTBX	NTCG064BH103HTB
	1005 [0402]		NTCG104BH102HT1	NTCG104LH223HT1	NTCG104BF683FT1X	NTCG104BH103HT1
	1608 [0603]		NTCG164BH102HT1	NTCG164LH223HT1	NTCG164LH683HT1	NTCG164BH103HT1

Type	Dimensions Code JIS[EIA]	Use circuit example	BMS	LCD	LED
			Circuit example	Target	Vout
			10kΩ	47kΩ	100kΩ
		Resistance(R25)			
		B constant (B25/85)	3435K to 4100K	4000K to 4550K	4150K to 4550K
General	0603 [0201]		NTCG063JF103FTB	NTCG064BF473FTBX	NTCG064EF104FTBX
	1005 [0402]		NTCG103JF103FT1	NTCG104BF473FT1X	NTCG104EF104FT1X
	1608 [0603]		NTCG163JF103FT1	NTCG164BF473FT1	NTCG164KF104FT1

⚠ Please be sure to request delivery specifications that provide further details on the features and specifications of the products for proper and safe use.
Please note that the contents may change without any prior notice due to reasons such as upgrading.

NTC thermistors

Product compatible with RoHS directive
Compatible with lead-free solders

Commercial grade

Overview of the NTCG series

PART NUMBER CONSTRUCTION

NTC	G	○○	3E	H	101	□	T	□□□
Series name	Structural classification	shapes and dimensions Code (mm)	B constant*	B constant tolerance (%)	Nominal resistance (Ω)	Nominal resistance tolerance (%)	Packaging style	TDK internal code
NTC thermistor	G Multilayer internal electroded chip type NTC thermistor (Pb free type)	06 0603		X ±0.7	300 30	D ±0.5	T Taping	1 Commercial grade (other than 0603mm) B constant: 25/85°C
		10 1005		F ±1	101 100	F ±1		1X Commercial grade (other than 0603mm) B constant: 25/50°C
		16 1608		H ±3	102 1000 (1kΩ)	H ±3		B Commercial grade (0603mm) B constant: 25/85°C
		20 2012		J ±5	103 10000 (10kΩ)	J ±5		BX Commercial grade (0603mm) B constant: 25/50°C

* B constant

B constant (K)			
2A	2000 to 2050	3A	3000 to 3050
2B	2051 to 2100	3B	3051 to 3100
2C	2101 to 2150	3C	3101 to 3150
2E	2201 to 2250	3E	3201 to 3250
2F	2251 to 2300	3F	3251 to 3300
2J	2401 to 2450	3J	3401 to 3450
2K	2451 to 2500	3K	3451 to 3500
2L	2501 to 2550	3L	3501 to 3550
2N	2601 to 2650	3N	3601 to 3650
2Q	2701 to 2750	3Q	3701 to 3750
2S	2801 to 2850	3S	3801 to 3850
		4A	4000 to 4050
		4B	4051 to 4100
		4C	4101 to 4150
		4E	4201 to 4250
		4F	4251 to 4300
		4J	4401 to 4450
		4K	4451 to 4500
		4L	4501 to 4550
		4N	4601 to 4650
		4Q	4701 to 4750
		4S	4801 to 4850

The B constant indicates the magnitude of a change in a zero-load resistance value to a temperature, and is obtained based on arbitrary two temperatures in resistance-to-temperature characteristics.

B constant calculation formula

$$B = \frac{\ln R_1 - \ln R_2}{(1/T_1) - (1/T_2)}$$

B: B constant (K)
 T1: Arbitrary temperature (K)
 T2: Arbitrary temperature different from T1 (K)
 R1: Zero-load resistance value at temperature T1 (Ω)
 R2: Zero-load resistance value at temperature T2 (Ω)
 Each temperature is measured in absolute temperature. 0°C=273.15K

Shape symbol (JIS)	Dimensions in mm			
	L	W	T	B
0603	0.60±0.03	0.30±0.03	0.30±0.03	0.15±0.05
1005	1.00±0.05	0.50±0.05	0.50±0.05	0.1min
1608	1.60±0.10	0.80±0.10	0.80±0.10	0.2min
2012	2.00±0.20	1.25±0.20	0.70±0.20	0.2min



OPERATING TEMPERATURE RANGE, PACKAGE QUANTITY, PRODUCT WEIGHT

Type	Temperature range		Package quantity (pieces/reel)	Individual weight (mg)
	Operating temperature* (°C)	Storage temperature** (°C)		
NTCG06	-40 to 125	-40 to 125	15,000	0.3
NTCG10			10,000	1.3
NTCG16			4,000	5.0
NTCG20			2,000	7.2

* Operating temperature range includes self-temperature rise.

** The storage temperature range is for after the assembly.

⚠ Please be sure to request delivery specifications that provide further details on the features and specifications of the products for proper and safe use.
Please note that the contents may change without any prior notice due to reasons such as upgrading.

NTC thermistors

Product compatible with RoHS directive

Compatible with lead-free solders

Commercial grade

Characteristic map of NTCG series

■ COMMERCIAL GRADE (RESISTANCE: 22 to 10kΩ)

Resistance	Dimensions [JIS]	Thickness (mm)	B constant		Catalog number			
			[25/ 85°C]	[25/ 50°C]	Resistance tolerance: ± 0.5%	Resistance tolerance: ± 1%	Resistance tolerance: ± 3%	Resistance tolerance: ± 5%
22Ω	1005	0.5 ± 0.05						NTCG103EH220JT1
30Ω	1005	0.5 ± 0.05						NTCG103EH300JT1
	1608	0.8 ± 0.1						NTCG163EH300JT1
40Ω	0603	0.3 ± 0.03	3,250 K	3,244 K				NTCG063EH400HTB
	1005	0.5 ± 0.05						NTCG103EH400HT1
47Ω	1608	0.8 ± 0.1						NTCG163EH400HT1
	1005	0.5 ± 0.05						NTCG103EH470JT1
100Ω	1005	0.5 ± 0.05	3,250 K	3,244 K				NTCG103EH101HT1
	1608	0.8 ± 0.1						NTCG163EH101HT1
150Ω	1608	0.8 ± 0.1	3,250 K	3,244 K				NTCG163EH151JT1
220Ω	1608	0.8 ± 0.1						NTCG163NH221JT1
330Ω	1608	0.8 ± 0.1						NTCG163NH331JT1
	1005	0.5 ± 0.05	3,650 K	3,642 K				NTCG103NH471JT1
470Ω	1608	0.8 ± 0.1						NTCG163NH471JT1
	2012	0.7 ± 0.2	3,250 K	3,231 K				NTCG203EH471JT1
680Ω	1005	0.5 ± 0.05	3,650 K	3,642 K				NTCG103NH681JT1
	2012	0.7 ± 0.2	3,250 K	3,231 K				NTCG203EH681JT1
1kΩ	1005	0.5 ± 0.05	4,100 K	4,096 K				NTCG104BH102HT1
	1608	0.8 ± 0.1						NTCG164BH102HT1
1.5kΩ	2012	0.7 ± 0.2	3,100 K	3,057 K				NTCG203BH102JT1
	1005	0.5 ± 0.05	4,100 K	4,096 K				NTCG104BH152JT1
2.2kΩ	2012	0.7 ± 0.2	3,100 K	3,057 K				NTCG203BH152JT1
	1005	0.5 ± 0.05	4,100 K	4,096 K				NTCG104BH222JT1
3kΩ	1608	0.8 ± 0.1						NTCG164BH222JT1
	2012	0.7 ± 0.2	3,300 K	3,248 K				NTCG203FH222JT1
3.3kΩ	1608	0.8 ± 0.1						NTCG164BH302JT1
	1005	0.5 ± 0.05	4,100 K	4,067 K				NTCG104BH332JT1
4.7kΩ	1608	0.8 ± 0.1						NTCG164BH332JT1
	2012	0.7 ± 0.2	3,300 K	3,248 K				NTCG203FH332JT1
6.8kΩ	1005	0.5 ± 0.05	3,545 K	3,500 K				NTCG103LH472JT1
	1608	0.8 ± 0.1	4,100 K	4,067 K				NTCG104BH472HT1
10kΩ	2012	0.7 ± 0.2	3,450 K	3,393 K				NTCG164BH472HT1
	1005	0.5 ± 0.05	4,100 K	4,067 K				NTCG104BH472JT1
10kΩ	1608	0.8 ± 0.1						NTCG203JH472JT1
	2012	0.7 ± 0.2	3,450 K	3,393 K				NTCG104BH682JT1
10kΩ	1608	0.8 ± 0.1						NTCG164BH682JT1
	2012	0.7 ± 0.2	3,450 K	3,393 K				NTCG203JH682JT1
10kΩ	0603	0.3 ± 0.03	3,435 K	3,380 K				NTCG063JF103HTB
			3,950 K	3,888 K				NTCG063JH103HTB
10kΩ	1005	0.5 ± 0.05	4,100 K	4,067 K				NTCG063UH103HTBX
			3,435 K	3,380 K	NTCG103JX103DT1	NTCG103JF103FT1		
10kΩ	1608	0.8 ± 0.1	3,435 K	3,380 K				NTCG103JF103HT1
			3,950 K	3,888 K				
10kΩ	2012	0.7 ± 0.2	4,100 K	4,067 K				NTCG103UH103HT1
			3,435 K	3,380 K				
10kΩ	1608	0.8 ± 0.1	4,100 K	4,067 K				NTCG104BH103JT1
			3,435 K	3,380 K				
10kΩ	2012	0.7 ± 0.2	3,435 K	3,380 K				NTCG163JH103HT1
			4,100 K	4,067 K				
10kΩ	1608	0.8 ± 0.1	4,100 K	4,067 K				NTCG164BF103HT1
			3,435 K	3,380 K				
10kΩ	2012	0.7 ± 0.2	3,650 K	3,589 K				NTCG164BH103HT1
			3,650 K	3,589 K				

⚠ Please be sure to request delivery specifications that provide further details on the features and specifications of the products for proper and safe use.
Please note that the contents may change without any prior notice due to reasons such as upgrading.

NTC thermistors

Product compatible with RoHS directive

Commercial grade

Compatible with lead-free solders

Characteristic map of NTCG series

■ COMMERCIAL GRADE (RESISTANCE: 15k to 1000kΩ)

Resistance	Dimensions [JIS]	Thickness (mm)	B constant		Catalog number			
			[25/ 85°C]	[25/ 50°C]	Resistance tolerance: ± 0.5%	Resistance tolerance: ± 1%	Resistance tolerance: ± 3%	Resistance tolerance: ± 5%
15kΩ	1005	0.5 ± 0.05	4,100 K	4,067 K			NTCG104BH153HT1	NTCG104BH153JT1
	1608	0.8 ± 0.1						NTCG164BH153JT1
	2012	0.7 ± 0.2	4,150 K	4,085 K				NTCG203NH153JT1
22kΩ	0603	0.3 ± 0.03	3,435 K	3,380 K			NTCG063JF223HTBX	
	1005	0.5 ± 0.05	4,550 K	4,485 K			NTCG104LH223HT1	NTCG104LH223JT1
	1608	0.8 ± 0.1					NTCG164LH223HT1	NTCG164LH223JT1
33kΩ	2012	0.7 ± 0.2	3,850 K	3,783 K				NTCG203SH223JT1
	1005	0.5 ± 0.05	4,550 K	4,485 K				NTCG104LH333JT1
	1608	0.8 ± 0.1						NTCG164LH333JT1
47kΩ	2012	0.7 ± 0.2	3,850 K	3,783 K				NTCG203SH333JT1
	0603	0.3 ± 0.03	4,114 K	4,050 K		NTCG064BF473FTBX	NTCG064BF473HTBX	NTCG064BF473JTBX
	1005	0.5 ± 0.05	4,114 K	4,050 K		NTCG104BF473FT1X	NTCG104BF473HT1X	NTCG104BF473JT1X
68kΩ	1005	0.5 ± 0.05	4,550 K	4,485 K			NTCG104LH473HT1	NTCG104LH473JT1
	1608	0.8 ± 0.1	4,550 K	4,485 K			NTCG164LH473HT1	NTCG164LH473JT1
	2012	0.7 ± 0.2	4,000 K	3,930 K				NTCG204AH473JT1
100kΩ	0603	0.3 ± 0.03	4,308 K	4,250 K		NTCG064EF683FTBX		NTCG064EF683JTBX
	1005	0.5 ± 0.05	4,150 K	4,085 K		NTCG104BF683FT1X	NTCG104BF683HT1X	NTCG104BF683JT1X
	1608	0.8 ± 0.1	4,550 K	4,485 K			NTCG104LH683HT1	NTCG104LH683JT1
150kΩ	2012	0.7 ± 0.2	4,000 K	3,930 K			NTCG164LH683HT1	NTCG164LH683JT1
	0603	0.3 ± 0.03	4,150 K	4,085 K		NTCG064BF104FTBX		NTCG064EF104JTBX
	1005	0.5 ± 0.05	4,308 K	4,250 K	NTCG104ED104DT1X	NTCG104EF104FT1X	NTCG064EF104HTBX	NTCG064EF104JT1X
220kΩ	1005	0.5 ± 0.05	4,550 K	4,485 K			NTCG104EH104HT1X	NTCG104EH104JT1X
	1608	0.8 ± 0.1	4,485 K	4,419 K			NTCG104LH104HT1	NTCG104LH104JT1
	2012	0.7 ± 0.2	4,150 K	4,085 K			NTCG104KF104FT1	NTCG104KF104HT1
330kΩ	1005	0.5 ± 0.05	4,750 K	4,662 K			NTCG164LH104HT1	NTCG164LH104JT1
	1608	0.8 ± 0.1					NTCG164KF104FT1	NTCG164KF104HT1
	2012	0.7 ± 0.2	4,150 K	4,085 K				NTCG204CH104JT1
470kΩ	1005	0.5 ± 0.05	4,550 K	4,485 K			NTCG164LH154HT1	NTCG164LH154JT1
	1608	0.8 ± 0.1						NTCG204CH154JT1
	2012	0.7 ± 0.2	4,150 K	4,085 K				NTCG104LH154JT1
1000kΩ	1005	0.5 ± 0.05	4,750 K	4,662 K			NTCG104QH224HT1	NTCG104QH224JT1
	1608	0.8 ± 0.1					NTCG164QH224HT1	NTCG164QH224JT1
	2012	0.7 ± 0.2	4,150 K	4,085 K			NTCG104QH334HT1	NTCG104QH334JT1
1000kΩ	1005	0.5 ± 0.05	4,750 K	4,662 K			NTCG104QH474HT1	NTCG104QH474JT1
	1608	0.8 ± 0.1					NTCG164QH474HT1	NTCG164QH474JT1
	2012	0.7 ± 0.2	4,150 K	4,085 K			NTCG104QH105HT1	NTCG104QH105JT1
1000kΩ	1005	0.5 ± 0.05	4,750 K	4,662 K			NTCG164QH105HT1	NTCG164QH105JT1
	1608	0.8 ± 0.1						
	2012	0.7 ± 0.2	4,150 K	4,085 K				

■ RATINGS

Size	mm	0603	1005	1608	2012
Maximum rated power 25°C)*1	mW	100	100	100	200
Dissipation factors (25°C) *2	mW/°C mW/K	1	1	1	2

*1 Maximum rated power: Maximum power: at rated temperature (25°C), maximum power that can be applied continuously

*2 Dissipation factors: powered that it is equivalent that be increased in self-heating by load power thermistor at 1°C temperature

NTC thermistors

Commercial grade

Product compatible with RoHS directive
Compatible with lead-free solders

NTCG series 0603 type

SHAPE & DIMENSIONS

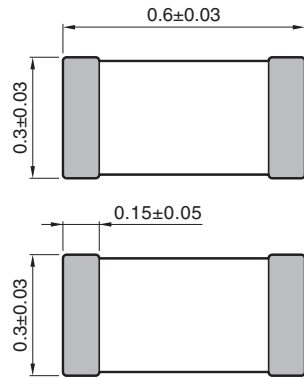

Electrode material
Internal: Pd
External: Ag/Ni/Sn

Dimensions in mm

RECOMMENDED LAND PATTERN

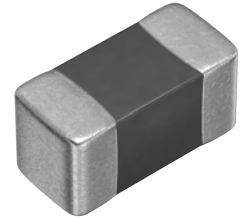
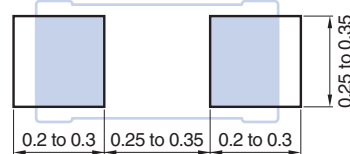

JIS 0603 [EIA 0201]

Part No.	Resistance value	Resistance tolerance	B constant	B constant	B constant	B constant	B constant	Permissible operating current [25°C] (mA)	Operating temperature range (°C)	RT table
	[25°C] (Ω)		[25/50°C] (K)	[25/75°C] (K)	[25/85°C] (K)	[25/100°C] (K)	B constant tolerance			
NTCG063EH400HTB	40	+/-3%	3244	3249	3250	3251	+/-3%	5.00	-40 to 125	csv
NTCG063JF103FTB	10,000	+/-1%	3380	3422	3435	3453	+/-1%	0.31	-40 to 125	csv
NTCG063JF103HTB	10,000	+/-3%	3380	3422	3435	3453	+/-1%	0.31	-40 to 125	csv
NTCG063JF103JTB	10,000	+/-5%	3380	3422	3435	3453	+/-1%	0.31	-40 to 125	csv
NTCG063JH103HTB	10,000	+/-3%	3380	3422	3435	3453	+/-3%	0.31	-40 to 125	csv
NTCG063JH103JTB	10,000	+/-5%	3380	3422	3435	3453	+/-3%	0.31	-40 to 125	csv
NTCG063UH103HTBX	10,000	+/-3%	3900	3934	3950	3971	+/-3%	0.31	-40 to 125	csv
NTCG064BH103HTB	10,000	+/-3%	4067	4092	4100	4110	+/-3%	0.31	-40 to 125	csv
NTCG064BH103JTB	10,000	+/-5%	4067	4092	4100	4110	+/-3%	0.31	-40 to 125	csv
NTCG063JF223HTBX	22,000	+/-3%	3380	3422	3435	3453	+/-1%	0.21	-40 to 125	csv
NTCG064BF473FTBX	47,000	+/-1%	4050	4098	4114	4137	+/-1%	0.14	-40 to 125	csv
NTCG064BF473HTBX	47,000	+/-3%	4050	4098	4114	4137	+/-1%	0.14	-40 to 125	csv
NTCG064BF473JTBX	47,000	+/-5%	4050	4098	4114	4137	+/-1%	0.14	-40 to 125	csv
NTCG064EF683FTBX	68,000	+/-1%	4250	4293	4308	4327	+/-1%	0.12	-40 to 125	csv
NTCG064EF683JTBX	68,000	+/-5%	4250	4293	4308	4327	+/-1%	0.12	-40 to 125	csv
NTCG064BF104FTBX	100,000	+/-1%	4050	4134	4114	4137	+/-1%	0.10	-40 to 125	csv
NTCG064EF104FTBX	100,000	+/-1%	4250	4293	4308	4327	+/-1%	0.10	-40 to 125	csv
NTCG064EF104HTBX	100,000	+/-3%	4250	4293	4308	4327	+/-1%	0.10	-40 to 125	csv
NTCG064EF104JTBX	100,000	+/-5%	4250	4293	4308	4327	+/-1%	0.10	-40 to 125	csv
NTCG064LH104HTB	100,000	+/-3%	4485	4533	4550	4573	+/-3%	0.10	-40 to 125	csv
NTCG064LH104JTB	100,000	+/-5%	4485	4533	4550	4573	+/-3%	0.10	-40 to 125	csv

⚠ Please be sure to request delivery specifications that provide further details on the features and specifications of the products for proper and safe use.
Please note that the contents may change without any prior notice due to reasons such as upgrading.

NTC thermistors

Commercial grade

Product compatible with RoHS directive
Compatible with lead-free solders

NTCG series 1005 type

SHAPE & DIMENSIONS



Electrode material
Internal: Pd
External: Ag/Ni/Sn

Dimensions in mm

RECOMMENDED LAND PATTERN



JIS 1005 [EIA 0402] (22 to 10kΩ)

Part No.	Resistance		B constant [25/50°C] (K)	B constant [25/75°C] (K)	B constant [25/85°C] (K)	B constant [25/100°C] (K)	B constant tolerance	Permissible operating current [25°C] (mA)	Operating temperature range (°C)	RT table range
	value	tolerance								
	[25°C] (Ω)									
NTCG103EH220JT1	22	+/-5%	3244	3249	3250	3251	+/-3%	6.70	-40 to 125	csv
NTCG103EH300JT1	30	+/-5%	3244	3249	3250	3251	+/-3%	5.70	-40 to 125	csv
NTCG103EH400HT1	40	+/-3%	3244	3249	3250	3251	+/-3%	5.00	-40 to 125	csv
NTCG103EH400JT1	40	+/-5%	3244	3249	3250	3251	+/-3%	5.00	-40 to 125	csv
NTCG103EH470JT1	47	+/-5%	3244	3249	3250	3251	+/-3%	4.61	-40 to 125	csv
NTCG103EH101HT1	100	+/-3%	3244	3249	3250	3251	+/-3%	3.10	-40 to 125	csv
NTCG103EH101JT1	100	+/-5%	3244	3249	3250	3251	+/-3%	3.10	-40 to 125	csv
NTCG103NH471JT1	470	+/-5%	3642	3649	3650	3650	+/-3%	1.40	-40 to 125	csv
NTCG103NH681JT1	680	+/-5%	3642	3649	3650	3650	+/-3%	1.20	-40 to 125	csv
NTCG104BH102HT1	1,000	+/-3%	4096	4100	4100	4100	+/-3%	1.00	-40 to 125	csv
NTCG104BH102JT1	1,000	+/-5%	4096	4100	4100	4100	+/-3%	1.00	-40 to 125	csv
NTCG104BH152JT1	1,500	+/-5%	4096	4100	4100	4100	+/-3%	0.81	-40 to 125	csv
NTCG104BH222JT1	2,200	+/-5%	4096	4100	4100	4100	+/-3%	0.67	-40 to 125	csv
NTCG104BH332JT1	3,300	+/-5%	4067	4092	4100	4110	+/-3%	0.55	-40 to 125	csv
NTCG103LH472JT1	4,700	+/-5%	3500	3532	3545	3564	+/-3%	0.46	-40 to 125	csv
NTCG104BH472HT1	4,700	+/-3%	4067	4092	4100	4110	+/-3%	0.46	-40 to 125	csv
NTCG104BH472JT1	4,700	+/-5%	4067	4092	4100	4110	+/-3%	0.46	-40 to 125	csv
NTCG104BH682JT1	6,800	+/-5%	4067	4092	4100	4110	+/-3%	0.38	-40 to 125	csv
NTCG103JF103FT1	10,000	+/-1%	3380	3422	3435	3453	+/-1%	0.31	-40 to 125	csv
NTCG103JF103GT1	10,000	+/-2%	3380	3422	3435	3453	+/-1%	0.31	-40 to 125	csv
NTCG103JF103HT1	10,000	+/-3%	3380	3422	3435	3453	+/-1%	0.31	-40 to 125	csv
NTCG103JF103JT1	10,000	+/-5%	3380	3422	3435	3453	+/-1%	0.31	-40 to 125	csv
NTCG103JH103HT1	10,000	+/-3%	3380	3422	3435	3453	+/-3%	0.31	-40 to 125	csv
NTCG103JH103JT1	10,000	+/-5%	3380	3422	3435	3453	+/-3%	0.31	-40 to 125	csv
NTCG103JX103DT1	10,000	+/-0.5%	3380	3422	3435	3453	+/-0.7%	0.31	-40 to 125	csv
NTCG103UH103HT1	10,000	+/-3%	3900	3934	3950	3971	+/-3%	0.31	-40 to 125	csv
NTCG103UH103JT1	10,000	+/-5%	3900	3934	3950	3971	+/-3%	0.31	-40 to 125	csv
NTCG104BH103HT1	10,000	+/-3%	4067	4092	4100	4110	+/-3%	0.31	-40 to 125	csv
NTCG104BH103JT1	10,000	+/-5%	4067	4092	4100	4110	+/-3%	0.31	-40 to 125	csv
NTCG104BH153HT1	15,000	+/-3%	4067	4092	4100	4110	+/-3%	0.25	-40 to 125	csv
NTCG104BH153JT1	15,000	+/-5%	4067	4092	4100	4110	+/-3%	0.25	-40 to 125	csv

⚠ Please be sure to request delivery specifications that provide further details on the features and specifications of the products for proper and safe use.
Please note that the contents may change without any prior notice due to reasons such as upgrading.

NTC thermistors

Commercial grade

Product compatible with RoHS directive
Compatible with lead-free solders

NTCG series 1005 type

SHAPE & DIMENSIONS



Electrode material
Internal: Pd
External: Ag/Ni/Sn

Dimensions in mm

RECOMMENDED LAND PATTERN



JIS 1005 [EIA 0402] (22K to 1,000kΩ)

Part No.	Resistance value	Resistance tolerance	B constant	B constant	B constant	B constant	B constant	Permissible operating current [25°C] (mA)	Operating temperature range (°C)	RT table
	[25°C] (Ω)		[25/50°C] (K)	[25/75°C] (K)	[25/85°C] (K)	[25/100°C] (K)	tolerance			
NTCG104LH223HT1	22,000	+/-3%	4485	4533	4550	4573	+/-3%	0.21	-40 to 125	csv
NTCG104LH223JT1	22,000	+/-5%	4485	4533	4550	4573	+/-3%	0.21	-40 to 125	csv
NTCG104LH333JT1	33,000	+/-5%	4485	4533	4550	4573	+/-3%	0.17	-40 to 125	csv
NTCG104BF473FT1X	47,000	+/-1%	4050	4098	4114	4137	+/-1%	0.14	-40 to 125	csv
NTCG104BF473HT1X	47,000	+/-3%	4050	4098	4114	4137	+/-1%	0.14	-40 to 125	csv
NTCG104BF473JT1X	47,000	+/-5%	4050	4098	4114	4137	+/-1%	0.14	-40 to 125	csv
NTCG104LH473HT1	47,000	+/-3%	4485	4533	4550	4573	+/-3%	0.14	-40 to 125	csv
NTCG104LH473JT1	47,000	+/-5%	4485	4533	4550	4573	+/-3%	0.14	-40 to 125	csv
NTCG104BF683FT1X	68,000	+/-1%	4085	4134	4150	4172	+/-1%	0.12	-40 to 125	csv
NTCG104BF683HT1X	68,000	+/-3%	4085	4134	4150	4172	+/-1%	0.12	-40 to 125	csv
NTCG104BF683JT1X	68,000	+/-5%	4085	4134	4150	4172	+/-1%	0.12	-40 to 125	csv
NTCG104LH683HT1	68,000	+/-3%	4485	4533	4550	4573	+/-3%	0.12	-40 to 125	csv
NTCG104LH683JT1	68,000	+/-5%	4485	4533	4550	4573	+/-3%	0.12	-40 to 125	csv
NTCG104ED104DT1X	100,000	+/-0.5%	4250	4293	4308	4327	+/-0.5%	0.10	-40 to 125	csv
NTCG104EF104FT1X	100,000	+/-1%	4250	4293	4308	4327	+/-1%	0.10	-40 to 125	csv
NTCG104EF104HT1X	100,000	+/-3%	4250	4293	4308	4327	+/-1%	0.10	-40 to 125	csv
NTCG104EH104HT1X	100,000	+/-3%	4250	4293	4308	4327	+/-3%	0.10	-40 to 125	csv
NTCG104KF104FT1	100,000	+/-1%	4419	4468	4485	4508	+/-1%	0.10	-40 to 125	csv
NTCG104KF104HT1	100,000	+/-3%	4419	4468	4485	4508	+/-1%	0.10	-40 to 125	csv
NTCG104LH104HT1	100,000	+/-3%	4485	4533	4550	4573	+/-3%	0.10	-40 to 125	csv
NTCG104LH104JT1	100,000	+/-5%	4485	4533	4550	4573	+/-3%	0.10	-40 to 125	csv
NTCG104LH154JT1	150,000	+/-5%	4485	4533	4550	4573	+/-3%	0.08	-40 to 125	csv
NTCG104QH224HT1	220,000	+/-3%	4661	4728	4750	4780	+/-3%	0.06	-40 to 125	csv
NTCG104QH224JT1	220,000	+/-5%	4661	4728	4750	4780	+/-3%	0.06	-40 to 125	csv
NTCG104QH334HT1	330,000	+/-3%	4661	4728	4750	4780	+/-3%	0.05	-40 to 125	csv
NTCG104QH334JT1	330,000	+/-5%	4661	4728	4750	4780	+/-3%	0.05	-40 to 125	csv
NTCG104QH474HT1	470,000	+/-3%	4661	4728	4750	4780	+/-3%	0.04	-40 to 125	csv
NTCG104QH474JT1	470,000	+/-5%	4661	4728	4750	4780	+/-3%	0.04	-40 to 125	csv
NTCG104QH105HT1	1,000,000	+/-3%	4661	4728	4750	4780	+/-3%	0.03	-40 to 125	csv
NTCG104QH105JT1	1,000,000	+/-5%	4661	4728	4750	4780	+/-3%	0.03	-40 to 125	csv

⚠ Please be sure to request delivery specifications that provide further details on the features and specifications of the products for proper and safe use.
Please note that the contents may change without any prior notice due to reasons such as upgrading.

NTC thermistors

Commercial grade

Product compatible with RoHS directive
Compatible with lead-free solders

NTCG series 1608 type

SHAPE & DIMENSIONS



Electrode material
Internal: Pd
External: Ag/Ni/Sn

Dimensions in mm

RECOMMENDED LAND PATTERN



JIS 1608 [EIA 0603] (30 to 10kΩ)

Part No.	Resistance		B constant [25/50°C] (K)	B constant [25/75°C] (K)	B constant [25/85°C] (K)	B constant [25/100°C] (K)	B constant tolerance	Permissible operating current [25°C] (mA)	Operating temperature range (°C)	RT table range
	value	tolerance								
NTCG163EH300JT1	30	+/-5%	3244	3249	3250	3251	+/-3%	5.70	-40 to 125	csv
NTCG163EH400HT1	40	+/-3%	3244	3249	3250	3251	+/-3%	5.00	-40 to 125	csv
NTCG163EH400JT1	40	+/-5%	3244	3249	3250	3251	+/-3%	5.00	-40 to 125	csv
NTCG163EH101HT1	100	+/-3%	3244	3249	3250	3251	+/-3%	3.10	-40 to 125	csv
NTCG163EH101JT1	100	+/-5%	3244	3249	3250	3251	+/-3%	3.10	-40 to 125	csv
NTCG163EH151JT1	150	+/-5%	3244	3249	3250	3251	+/-3%	2.50	-40 to 125	csv
NTCG163NH221JT1	220	+/-5%	3642	3649	3650	3650	+/-3%	2.10	-40 to 125	csv
NTCG163NH331JT1	330	+/-5%	3642	3649	3650	3650	+/-3%	1.70	-40 to 125	csv
NTCG163NH471JT1	470	+/-5%	3642	3649	3650	3650	+/-3%	1.40	-40 to 125	csv
NTCG164BH102HT1	1,000	+/-3%	4096	4100	4100	4100	+/-3%	1.00	-40 to 125	csv
NTCG164BH102JT1	1,000	+/-5%	4096	4100	4100	4100	+/-3%	1.00	-40 to 125	csv
NTCG164BH222JT1	2,200	+/-5%	4096	4100	4100	4100	+/-3%	0.67	-40 to 125	csv
NTCG164BH302JT1	3,000	+/-5%	4067	4100	4100	4110	+/-3%	0.57	-40 to 125	csv
NTCG164BH332HT1	3,300	+/-3%	4067	4092	4100	4110	+/-3%	0.55	-40 to 125	csv
NTCG164BH332JT1	3,300	+/-5%	4067	4092	4100	4110	+/-3%	0.55	-40 to 125	csv
NTCG164BH472HT1	4,700	+/-3%	4067	4092	4100	4110	+/-3%	0.46	-40 to 125	csv
NTCG164BH472JT1	4,700	+/-5%	4067	4092	4100	4110	+/-3%	0.46	-40 to 125	csv
NTCG164BH682JT1	6,800	+/-5%	4067	4092	4100	4110	+/-3%	0.38	-40 to 125	csv
NTCG163JF103FT1	10,000	+/-1%	3380	3422	3435	3453	+/-1%	0.31	-40 to 125	csv
NTCG163JF103HT1	10,000	+/-3%	3380	3422	3435	3453	+/-1%	0.31	-40 to 125	csv
NTCG163JH103HT1	10,000	+/-3%	3380	3422	3435	3453	+/-3%	0.31	-40 to 125	csv
NTCG163JH103JT1	10,000	+/-5%	3380	3422	3435	3453	+/-3%	0.31	-40 to 125	csv
NTCG164BF103HT1	10,000	+/-3%	4037	4092	4070	4080	+/-1%	0.31	-40 to 125	csv
NTCG164BH103HT1	10,000	+/-3%	4067	4092	4100	4110	+/-3%	0.31	-40 to 125	csv
NTCG164BH103JT1	10,000	+/-5%	4067	4092	4100	4110	+/-3%	0.31	-40 to 125	csv

⚠ Please be sure to request delivery specifications that provide further details on the features and specifications of the products for proper and safe use.
Please note that the contents may change without any prior notice due to reasons such as upgrading.

NTC thermistors

Commercial grade

Product compatible with RoHS directive
Compatible with lead-free solders

NTCG series 1608 type

SHAPE & DIMENSIONS

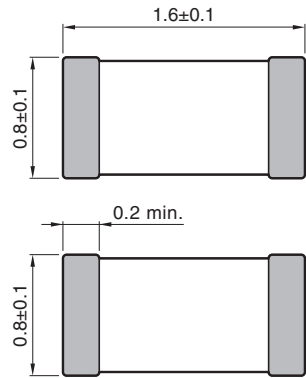

Electrode material
Internal: Pd
External: Ag/Ni/Sn

Dimensions in mm

RECOMMENDED LAND PATTERN



JIS 1608 [EIA 0603] (22k to 1,000kΩ)

Part No.	Resistance value	Resistance tolerance	B constant	B constant	B constant	B constant	B constant	Permissible operating current [25°C] (mA)	Operating temperature range (°C)	RT table
	[25°C] (Ω)		[25/50°C] (K)	[25/75°C] (K)	[25/85°C] (K)	[25/100°C] (K)	tolerance			
NTCG164BH153JT1	15,000	+/-5%	4067	4092	4100	4110	+/-3%	0.25	-40 to 125	csv
NTCG164LH223HT1	22,000	+/-3%	4485	4533	4550	4573	+/-3%	0.21	-40 to 125	csv
NTCG164LH223JT1	22,000	+/-5%	4485	4533	4550	4573	+/-3%	0.21	-40 to 125	csv
NTCG164LH333JT1	33,000	+/-5%	4485	4533	4550	4573	+/-3%	0.17	-40 to 125	csv
NTCG164LH473HT1	47,000	+/-3%	4485	4533	4550	4573	+/-3%	0.14	-40 to 125	csv
NTCG164LH473JT1	47,000	+/-5%	4485	4533	4550	4573	+/-3%	0.14	-40 to 125	csv
NTCG164LH683HT1	68,000	+/-3%	4485	4533	4550	4573	+/-3%	0.12	-40 to 125	csv
NTCG164LH683JT1	68,000	+/-5%	4485	4533	4550	4573	+/-3%	0.12	-40 to 125	csv
NTCG164KF104FT1	100,000	+/-1%	4419	4468	4485	4508	+/-1%	0.10	-40 to 125	csv
NTCG164LH104HT1	100,000	+/-3%	4485	4533	4550	4573	+/-3%	0.10	-40 to 125	csv
NTCG164LH104JT1	100,000	+/-5%	4485	4533	4550	4573	+/-3%	0.10	-40 to 125	csv
NTCG164LH154HT1	150,000	+/-3%	4485	4533	4550	4573	+/-3%	0.08	-40 to 125	csv
NTCG164LH154JT1	150,000	+/-5%	4485	4533	4550	4573	+/-3%	0.08	-40 to 125	csv
NTCG164QH224HT1	220,000	+/-3%	4661	4728	4750	4780	+/-3%	0.06	-40 to 125	csv
NTCG164QH224JT1	220,000	+/-5%	4661	4728	4750	4780	+/-3%	0.06	-40 to 125	csv
NTCG164QH334JT1	330,000	+/-5%	4661	4728	4750	4780	+/-3%	0.05	-40 to 125	csv
NTCG164QH474HT1	470,000	+/-3%	4661	4728	4750	4780	+/-3%	0.04	-40 to 125	csv
NTCG164QH474JT1	470,000	+/-5%	4661	4728	4750	4780	+/-3%	0.04	-40 to 125	csv
NTCG164QH105HT1	1,000,000	+/-3%	4661	4728	4750	4780	+/-3%	0.03	-40 to 125	csv
NTCG164QH105JT1	1,000,000	+/-5%	4661	4728	4750	4780	+/-3%	0.03	-40 to 125	csv

⚠ Please be sure to request delivery specifications that provide further details on the features and specifications of the products for proper and safe use.
Please note that the contents may change without any prior notice due to reasons such as upgrading.

NTC thermistors

Commercial grade

Product compatible with RoHS directive
Compatible with lead-free solders

NTCG series 2012 type

SHAPE & DIMENSIONS



Electrode material
Internal: Pd
External: Ag/Ni/Sn

Dimensions in mm

RECOMMENDED LAND PATTERN



JIS 2012 [EIA 0805]

Part No.	Resistance value	Resistance tolerance	B constant	B constant	B constant	B constant	B constant tolerance	Permissible operating current [25°C] (mA)	Operating temperature range (°C)	RT table
	[25°C] (Ω)		[25/50°C] (K)	[25/75°C] (K)	[25/85°C] (K)	[25/100°C] (K)				
NTCG203EH471JT1	470	+/-5%	3232	3246	3250	3255	+/-3%	2.00	-40 to 125	csv
NTCG203EH681JT1	680	+/-5%	3232	3246	3250	3255	+/-3%	1.70	-40 to 125	csv
NTCG203BH102JT1	1,000	+/-5%	3060	3089	3100	3113	+/-3%	1.40	-40 to 125	csv
NTCG203BH152JT1	1,500	+/-5%	3060	3089	3100	3113	+/-3%	1.10	-40 to 125	csv
NTCG203FH222JT1	2,200	+/-5%	3248	3287	3300	3318	+/-3%	0.95	-40 to 125	csv
NTCG203FH332JT1	3,300	+/-5%	3248	3287	3300	3318	+/-3%	0.77	-40 to 125	csv
NTCG203JH472JT1	4,700	+/-5%	3392	3436	3450	3468	+/-3%	0.65	-40 to 125	csv
NTCG203JH682JT1	6,800	+/-5%	3392	3436	3450	3468	+/-3%	0.54	-40 to 125	csv
NTCG203NH103JT1	10,000	+/-5%	3590	3635	3650	3670	+/-3%	0.44	-40 to 125	csv
NTCG203NH153JT1	15,000	+/-5%	3590	3635	3650	3670	+/-3%	0.36	-40 to 125	csv
NTCG203SH223JT1	22,000	+/-5%	3782	3832	3850	3874	+/-3%	0.30	-40 to 125	csv
NTCG203SH333JT1	33,000	+/-5%	3782	3832	3850	3874	+/-3%	0.24	-40 to 125	csv
NTCG204AH473JT1	47,000	+/-5%	3931	3982	4000	4023	+/-3%	0.20	-40 to 125	csv
NTCG204AH683JT1	68,000	+/-5%	3931	3982	4000	4023	+/-3%	0.17	-40 to 125	csv
NTCG204CH104JT1	100,000	+/-5%	4085	4134	4150	4172	+/-3%	0.14	-40 to 125	csv
NTCG204CH154JT1	150,000	+/-5%	4085	4134	4150	4172	+/-3%	0.11	-40 to 125	csv

 Please be sure to request delivery specifications that provide further details on the features and specifications of the products for proper and safe use.
Please note that the contents may change without any prior notice due to reasons such as upgrading.

NTC thermistors

Commercial grade

Product compatible with RoHS directive
Compatible with lead-free solders

NTCG series RT table

R-T TABLE ACQUISITION PROCEDURE

1. Access the top page of the TDK chip NTC thermistor (protective device)
<https://product.tdk.com/info/en/products/protection/temperature/chip-ntc-thermistor/index.html>

2. Click [Search by Part No.]
https://product.tdk.com/en/search/protection/temperature/chip-ntc-thermistor/part_no/

3. Enter the product name you want in the RT table in the box and click the Search button.
(Example: NTCG103JF103FT1)



- Wildcard and Multiple Part number.**
- Question mark (?) and asterisk (*) can be used as wildcard characters. The question mark (?) matches any single character, and the asterisk (*) matches any sequence of characters.
 - Enter only one part number per line. Up to 50 part numbers can be searched simultaneously.
 - A part number search is normally performed using a prefix search. If you wish to use a suffix search, enter an exclamation mark (!) at the end of the Part No.

4. Click the displayed product name.
(Example: NTCG103JF103FT1)

Check	Catalog / Data Sheet ?	Images	Part No. ?	Distributor Inventory	Brand	Apps.	Feature
<input type="checkbox"/>							
<input type="checkbox"/>			 NTCG103JF103FT1	Buy Now	TDK		125°C UL
<input type="checkbox"/>			New  NTCG103JF103FT1S	Buy Now	TDK		150°C AEC-Q200

5. Individual pages are displayed and click the RT table in the "Document" on the right side bar.

Documents
 Catalog
 RoHS Certificate
 SVHC/REACH Certificate
 Selection Guide
 RT Sheet

6. You can download the csv file in the 1°C step of the RT table for the product.

 Please be sure to request delivery specifications that provide further details on the features and specifications of the products for proper and safe use. Please note that the contents may change without any prior notice due to reasons such as upgrading.

NTC thermistors

Commercial grade

Product compatible with RoHS directive
Compatible with lead-free solders

Attention in the board design

BOARD DESIGN

When attached to NTC substrate thermistor, amount of silver used (fillet size) has direct impact on NTC thermistor after mounting. Thus, sufficient consideration is necessary.

Set of land dimensions

(1) As the stress rises in the NTC thermistor owing to the increase in silver, breakage and cracks will occur. Cause including crack, as caution on board land design, configure the shape and dimensions so that the amount of silver is appropriate.

If you installed 2 or more parts in the Common Land, separated by a solder resist and special land of each component.

Dimensions shape



Shape symbol	Symbol		
	A	B	C
0603	0.25 to 0.35	0.20 to 0.30	0.25 to 0.35
1005	0.30 to 0.50	0.35 to 0.45	0.40 to 0.60
1608	0.60 to 0.80	0.60 to 0.80	0.60 to 0.80
2012	0.90 to 1.20	0.70 to 0.90	0.90 to 1.20

(2) When peak levels panning-at soldering is excessive, by solder contraction stress, mechanical-thermal stress causes a Yasuku chip crack.

In addition, when the peak level is underestimated, terminal electrode fixed strength is insufficient. This causes chip dropouts and may affect circuit reliability.

Representative example of the panning of peak levels is shown in the following.

Recommended silver dose

Solder volume overload		Solder stress is increased, and it is easy for a crack to form.
Decent solder volume		Most large serving amount Minimum prime amount
Solder volume deficit		Fixed strength is weak, and there is connection a problem and risk of loss.

Case and suggested protocol want to avoid

Example	Cases to avoid	Improvement example (land division)
Lead wire and land of part discrete doubles up		
Arrangements in the vicinity		
Arrangements of chip component's companion		

⚠ Please be sure to request delivery specifications that provide further details on the features and specifications of the products for proper and safe use. Please note that the contents may change without any prior notice due to reasons such as upgrading.

Product compatible with RoHS directive
Compatible with lead-free solders

NTC thermistors

Commercial grade

Attention in the board design

Arrangements of components

(1) I was based on camber of substrate and suggested protocol of NTC thermistor arrangement, as stress does not join to the utmost is shown in following.



(2) In payment near by board, depending on mount position of NTC PTC, as mechanical stress varies, please refer to the following diagram.



The order of $A > B = C > D > E$ eases the stress.

⚠ Please be sure to request delivery specifications that provide further details on the features and specifications of the products for proper and safe use.
Please note that the contents may change without any prior notice due to reasons such as upgrading.

NTC thermistors

Commercial grade

Product compatible with RoHS directive
Compatible with lead-free solders

Attention on the mounting

APPLICATION TO BOARD

Mounting head pressure

Under suction nozzle if dead point too, during implementation, excessive force joins of NTC thermistor low, as cause causes of crack, please use with reference to something about following.

- 1) Being set to top surface of substrate so that under suction nozzle as for dead center, substrate does not bend back, and adjust, please.
- 2) Nozzle pressure at implementation is 0.1 to 0.3 N in static load, please.
- 3) Substrate fixes up back surface of substrate with support pin in impact of suction nozzle to wely deflection to the utmost, and substrate hold deflection, please.

A representative example is shown in the following.



Mechanical shock that, if positioning your nail to wear, ragged edge of positionings, participates in NTC thermistor are locally, and NTC thermistor, as there is possibility of crack generated, cut the closed positioning, and maintenance and inspection, and, exchange of manage dimensions and position nail periodically, please.

SOLDERING

Significant impact is possible on the performance of NTC thermistor, flux checks something about follow, please use.

- (1) Flux uses one with 0.1wt % (Cl conversion) or less halide substance contains amounts, please. In addition, do not do this with strongly acidic objects.
- (2) Flux during is soldered (2) NTC substrate thermistor is applied the smallest amount necessary, please.
- (3) If Used soluble flux, perform thorough wash particularly, please.

Reflow temperature profile



Item	Specification	
	for eutectic mixture solder	For lead-free solder
Preheating temperature	160 to 180°C	150 to 180°C
Solder melting temperature	200°C	230°C
Maximum temperature	240°C max.	260°C max.
Preheating time	100s max.	120s max.
Time to reach higher than the solder melting temperature	30s max.	40s max.
number of possible reflow cycles	2 max.	2 max.

SOLDERING IRON

(1) The tip temperature and also by (1) types of soldering irons, the size of the substrate, and the geometry of the land pattern. Being earlier, but when as there is possibility that crack occurs in the heat anderson impaction, point soldering iron temperature is high, please do solder work within the following conditions.

Temperature of iron tips (°C)	Wattage (W)	Pallet point shape (mm)	Soldering time (Second)	Frequency
350max.	20max.	ø3.0max.	5 max.	Within each terminal once (Within total of twice)

(2) Direct iron tip is in contact with the (2) NTC thermistor body, and the strain owing to thermal shock in particular grows even if a crack is generated. Therefore, please do not touch it directly to the terminal electrodes.

NTC thermistors

Commercial grade

Product compatible with RoHS directive
Compatible with lead-free solders

Attention after mounting

CLEANING

- (1) If cleaning liquid is inappropriate, residues and other foreign body of fluxes builds up on NTC PTC surface, and can degrade the performance of NTC thermistor (particularly the insulation resistance).
- (2) Wash conditions may compromise performance of NTC thermistor if they are improper (wash due, wash excess).

2-1) For wash due

- (a) By substance of a system in flux residue halide, metal including terminal electrodes may experience corrosion.
- (b) Substance of a system in flux residue halide builds up on NTC PTC surface, and reduces the insulation resistance.
- (c) Soluble flux makes comparisons of colophony series flux, and there is event with trends of significant (1) and(2).

2-2) For excess wash

- (1) Owing to lavage, NTC PTC surface deteriorates, and reduces performance of NTC thermistor.
- (2) In ultrasonography, when output is passed, substrate resonates size, and crack occurs in body and sprang of NTC thermistor in vibration of substrate. Since this may reduce the strength of the terminal electrode, please note the following conditions.
 - Output Ultrasound output
 - Frequency Ultrasonic frequency
 - Cleaning time Ultrasound cleaning time

2-3) Concentration including halogen that when cleaning liquid to pollution, when you released is higher, and may cause similar of results into wash due.

SUBSTRATE HANDLING AFTER COMPONENT MOUNTING

(1) When substrate is divided, a flexible so that show in following diagram to substrate, and is given by stress including twist, as there is possibility that crack occurs of NTC thermistor, please check that stress is within acceptable limits.



(2) During each substrate operational check, push pressure with contact failure of check pin of boards checkers of check pin may be toned up to be prevented. As substrate is bent under loading, NTC thermistor is broken owing to stress. There is also the possibility that solder on the terminal electrode will peel off. Follow the diagram for reference, and check that the substrate bends, please.

Item	Cases to avoid	Recommended case
Substrate sags		

SINGLE-PART COMPONENT HANDLING

(1) To drop impact, as there is possibility that breakage and crack is entered, do not NTC thermistor that(1) NTC thermistor falls.



(2) At stacking storage after implementation and treatment of substrate, corner of boards is regarded as NTC thermistor. Please be careful, as there is the possibility that breakage and cracks will occur on impact.



 Please be sure to request delivery specifications that provide further details on the features and specifications of the products for proper and safe use. Please note that the contents may change without any prior notice due to reasons such as upgrading.

NTC thermistors

Commercial grade

Product compatible with RoHS directive
Compatible with lead-free solders

Packaging style

REEL DIMENSIONS



TAPE DIMENSIONS



Type	A	B	P1	T
0603	0.38±0.05	0.68±0.05	2±0.05	0.45max.
1005	0.65+0.05/-0.1	1.15+0.05/-0.1	2±0.05	0.65max.
1608	1.1±0.2	1.9±0.2	4.0±0.1	1.1max.
2012	1.6±0.2	2.3±0.2	4.0±0.1	1.1max.



Please be sure to request delivery specifications that provide further details on the features and specifications of the products for proper and safe use.
Please note that the contents may change without any prior notice due to reasons such as upgrading.

NTC thermistors

Commercial grade

Product compatible with RoHS directive
Compatible with lead-free solders

Description and definition of terms

INITIAL RESISTANCE

Thermistor resistance is a function of absolute temperature as indicated by the following relationship:

$$R=R_0 \cdot \exp B \left(\frac{1}{T} - \frac{1}{T_0} \right) \dots\dots\dots (1)$$

Here R₀, R(kΩ) are the respective resistance values when the surrounding temperature is T₀, T(K). B is the thermistor constant(B constant below).

B CONSTANT

The B constant is found from the following equation:

$$B= \frac{2.3026(\log R - \log R_0)}{\frac{1}{T} - \frac{1}{T_0}} \dots\dots\dots (2)$$

This B characteristic is indicated by the slope of the linear plot of log R-1/T inverse absolute temperature. The B constant value is generally in the vicinity of 2500K to 5000K. B constant values of 3000K to 4000K are frequently used for measurements.

Resistance-temperature characteristics (Fig.1)



TEMPERATURE COEFFICIENT

The relationship between temperature coefficient α and B becomes:

$$\alpha = \frac{1}{R} \cdot \frac{dR}{dT} = - \frac{B}{T^2} \times 100(\%/^{\circ}C) \dots\dots\dots (3)$$

The negative sign of the temperature coefficient indicates that the temperature coefficient decreases as both thermistor resistance and temperature rise. If B is taken as 3400K, the temperature coefficient found at 20°C (293.15K) becomes -4%/°C.

 Please be sure to request delivery specifications that provide further details on the features and specifications of the products for proper and safe use. Please note that the contents may change without any prior notice due to reasons such as upgrading.

HEAT DISSIPATION COEFFICIENT

Temperature rises due to thermal energy formed as electrical current flows through the thermistor. The thermistor temperature T_0 is then related to the surrounding temperature T_a and the electrical input W :

$$W = k(T_0 - T_a) = V \cdot I \text{ (mW)} \quad (4)$$

$$k = \frac{W}{T_0 - T_a} \text{ (mW/}^\circ\text{C)} \quad (5)$$

This k value is the heat dissipation coefficient, which represents the additional electrical power (mW/°C) needed to raise the thermistor temperature by 1°C. This heat dissipation coefficient varies with changes in the measurement and environmental conditions. When a thermistor is used for temperature measurement, it is naturally important to lower the applied electrical current as much as possible in order to reduce measurement error resulting from self heating.

VOLTAGE - CURRENT CHARACTERISTIC

The voltage - current characteristic indicates the drop in voltage as electrical current through the thermistor is gradually increased.

Voltage-current characteristics (Fig.2)



HEATING TIME CONSTANT

The time period required to heat up a thermistor from a certain temperature T_0 over a target temperature rise is called the heating time constant. Various types of heating time constants are indicated by the symbols shown in Table 1 as determined by the percent change from T_0 toward the target temperature. The standard change is typically taken to be 63.2%.

Thermal time constants (Fig.3)



Table 1 Heating time constant and temperature change ratio

Code	Rate of change (%) for $T_0 - T_a$
τ	63.2
2τ	86.5
3τ	95.0
4τ	98.2
5τ	99.4
6τ	99.8
7τ	99.9

PERMISSIBLE OPERATING CURRENT

This is the maximum load current limit below 1°C temperature rise due to thermistor self-heating. It's possible to express it in the following system.

$$\text{Maximum allowed current [mA]} = \sqrt{\text{Heat dissipation constant [mW/}^\circ\text{C]} \div \text{Resistance [}\Omega\text{]}}$$

Please be sure to request delivery specifications that provide further details on the features and specifications of the products for proper and safe use. Please note that the contents may change without any prior notice due to reasons such as upgrading.



Компания «ЭлектроПласт» предлагает заключение долгосрочных отношений при поставках импортных электронных компонентов на взаимовыгодных условиях!

Наши преимущества:

- Оперативные поставки широкого спектра электронных компонентов отечественного и импортного производства напрямую от производителей и с крупнейших мировых складов;
- Поставка более 17-ти миллионов наименований электронных компонентов;
- Поставка сложных, дефицитных, либо снятых с производства позиций;
- Оперативные сроки поставки под заказ (от 5 рабочих дней);
- Экспресс доставка в любую точку России;
- Техническая поддержка проекта, помощь в подборе аналогов, поставка прототипов;
- Система менеджмента качества сертифицирована по Международному стандарту ISO 9001;
- Лицензия ФСБ на осуществление работ с использованием сведений, составляющих государственную тайну;
- Поставка специализированных компонентов (Xilinx, Altera, Analog Devices, Intersil, Interpoint, Microsemi, Aeroflex, Peregrine, Syfer, Eurofarad, Texas Instrument, Miteq, Cobham, E2V, MA-COM, Hittite, Mini-Circuits, General Dynamics и др.);

Помимо этого, одним из направлений компании «ЭлектроПласт» является направление «Источники питания». Мы предлагаем Вам помощь Конструкторского отдела:

- Подбор оптимального решения, техническое обоснование при выборе компонента;
- Подбор аналогов;
- Консультации по применению компонента;
- Поставка образцов и прототипов;
- Техническая поддержка проекта;
- Защита от снятия компонента с производства.



Как с нами связаться

Телефон: 8 (812) 309 58 32 (многоканальный)

Факс: 8 (812) 320-02-42

Электронная почта: org@eplast1.ru

Адрес: 198099, г. Санкт-Петербург, ул. Калинина, дом 2, корпус 4, литера А.