



## SeriesOneDR Timer

- 6 Amp AC and DC rated output
- Compact size (11mm wide)
- Dual SCR or MOSFET output
- AC/DC control
- Zero-crossing (resistive loads) or random-fire (inductive loads) AC output
- Timer status LED indicator
- UL listed, HP rated
- 8 Industry standard functions (A/At, B, C, D/Di, H/Ht, L/Li, Ac and Bw)

### PRODUCT SELECTION

Control Voltage	AC Output	DC Output
12-24 VAC/DC	DRTx24D06x	DRTx06D06
90-140 VAC/DC	DRTx24B06x	
180-280 VAC/DC	DRTx24A06x	

### AVAILABLE OPTIONS

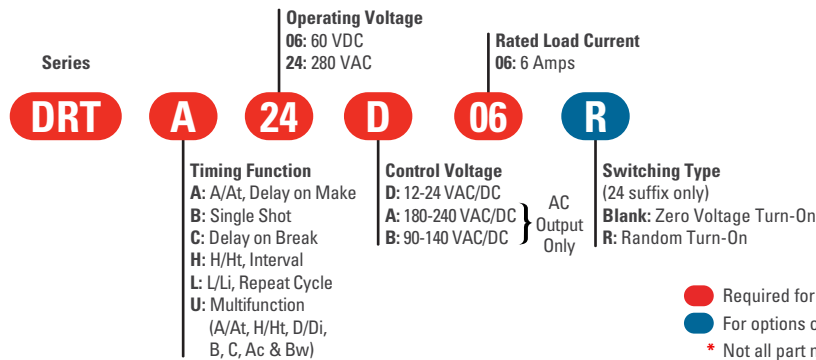

- Required for valid part number
- For options only and not required for valid part number
- \* Not all part number combinations are available. Contact Crydom Technical Support for information on the availability of a specific part number.

### OUTPUT SPECIFICATIONS <sup>(1)</sup>

Description	DRTx24	DRTx06
Operating Voltage	24-280 VAC (47-440Hz)	1-48 VDC
Transient Overvoltage [Vpk]	600	60 VDC
Rated Load Current <sup>(2)</sup>	6 Arms	6 A
Rated Load Current {UL508 Motor Controller} <sup>(2)</sup> [Arms]	3.6 Arms	-
Minimum Load Current	150 mArms	2.5 mA
Maximum Off-State Leakage Current @ Rated Voltage	0.1 mArms	0.25 mA
Minimum Off-State dv/dt @ Maximum Rated Voltage [V/μsec] <sup>(3)</sup>	500	-
Maximum Surge Current (AC output 1 cycle. DC output 10ms)	285/300 Apk (50/60Hz)	60 A
Maximum I <sup>2</sup> t for Fusing [A <sup>2</sup> sec]	410/375 (50/60Hz)	-
Maximum On-State Voltage Drop @ Rated Current [Vpk]	1.3	0.3 VDC
Maximum On-State Resistance (RDS-ON) [Ohms]	-	0.034
HP rating UL 508/IEC60947[HP (KW)]: 240 VAC	1/3 (0.24)	-
IEC 62314 LC-A [FLA]	6 A	-
IEC 62314 LC-B [Kw]	0.24	-
Wire Size min/max (solid/stranded) [AWG/ IEC mm <sup>2</sup> ] <sup>(4)</sup>	22/12 [0.33/3.31]	22/12 [0.33/3.31]
Output Terminal Screw Torque [in lb (Nm)]	7.0 (0.8)	7.0 (0.8)

**INPUT SPECIFICATIONS <sup>(1)</sup>**

Description	DRTxxxD06	DRTx24A06	DRTx24B06
Control Voltage Range	12-24 VAC/DC	180-280 VAC/DC	90-140 VAC/DC
Must Turn-Off Voltage	1 VAC/DC	20 VAC/DC	10 VAC/DC
Min Input Current @ Min Voltage (AC/DC) (for on-state)	7.6/6.3 mA (5)	7.2/7.1 mA	7.6/7.4 mA
Maximum Input Current @ Maximum Voltage	12.1/9.1 mA (6)	9.7/9.6 mA	12.5/12.3 mA
Nominal Input Impedance	2K Ohms(7)	25K ohms	12K ohms
Wire Size min-max (solid/stranded) [AWG/ IEC mm²] (4)	22-16 / 0.33-1.31	22-16 / 0.33-1.31	22-16 / 0.33-1.31
LED Status Indicator (Color)	Yes (green)	Yes (green)	Yes (green)
Input Terminal Screw Torque [in lb (Nm)]	4.4 (0.5)	4.4 (0.5)	4.4 (0.5)
Maximum turn-on/off time	See note (9)	See note (9)	See note (9)





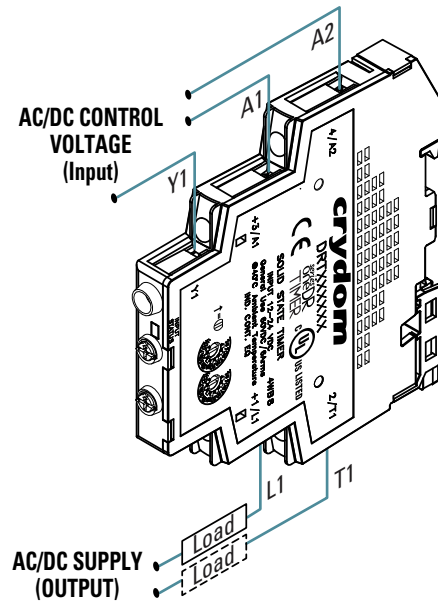
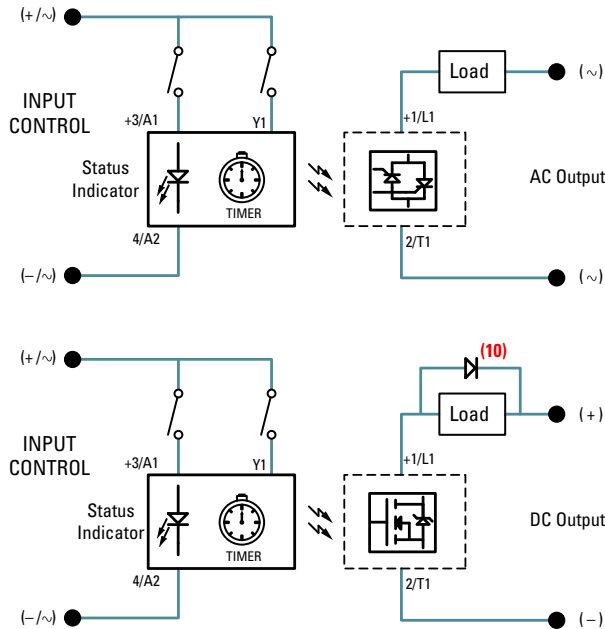

**GENERAL SPECIFICATIONS**

Description	Parameters
Dielectric Strength, Input/Output/Base (50/60Hz)	3750 Vrms (8)
Minimum Insulation Resistance (@ 500 VDC)	10 <sup>9</sup> Ohm
Maximum Capacitance, Input/Output	10 pF
Ambient Operating Temperature Range	-30 to 80 °C
Ambient Storage Temperature Range	-40 to 125 °C
Weight (typical)	1.76 oz (50 g)
Housing Material	UL 94 V0 Self-extinguishing
Terminal Finish	Sulfamate Nickel
Humidity	5 - 85% Non condensing
RoHS Exemption #'s	5(a), 7(a), 7(c)-I

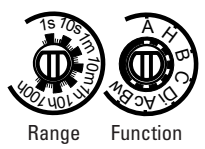
**WIRING DIAGRAM**

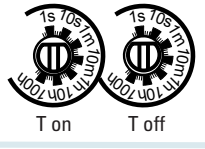
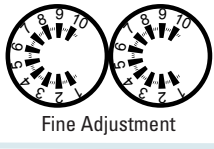

**TIMER SETTINGS & RANGES**

Timer Settings		
Timing Function	Identification	
	Side View	Front View
<b>U</b> Multifunction [A/At, H/Ht, D/Di, B, C, Ac, Bw]	 Range      Function	 Fine Adjustment
<b>L</b> Repeat Cycle	 T on      T off	 Fine Adjustment
<b>A</b> Delay on Make  <b>H</b> Interval  <b>B</b> Single Shot	 Range	 Fine Adjustment
<b>C</b> Delay on Break	 Flat side indicates selection	

Timing Ranges (11)	
Identification	Timing Range
1s	0.1 s to 1 s
10 s	1 s to 10 s
1 min	0.1 min to 1 min
10 min	1 min to 10 min
1 h	0.1 h to 1 h
10 h	1 h to 10 h
100 h	10 h to 100 h

**GENERAL NOTES**

- (1) All parameters at 25°C unless otherwise specified.
- (2) See derating curves.
- (3) Off-State dv/dt test method per EIA/NARM standard RD-443, paragraph 13.11.1
- (4) For UL Listing, must use wire rated @ 75°C.
- (5) For DC output model minimum current spec is 15.7/12.4ma (AC/DC).
- (6) For DC output model maximum current spec is 27.9/20.3ma (AC/DC).
- (7) For DC output mode, spec is 1K.
- (8) For DC output model, spec is 2500V.
- (9) Activation Time = 65ms / Deactivation Time = 100 ms.
- (10) Inductive loads must be diode suppressed to prevent damage to output.
- (11) Timing accuracy ± 10%. Additional functions and time ranges are also available, please contact your local authorized Crydom Distributor, Representative or Crydom Sales office and request information about our custom products.
- (12) Do not apply a push force greater than 9.8N(2.2lbf) and Stop torque 4Ncm.
- (13) Do not apply a push/pull force greater than 5N(1.12lbf) and torque 20Nm.

**MECHANICAL SPECIFICATIONS**

Tolerances: ±0.02 in / 0.5 mm  
 All dimensions are in: inches [millimeters]

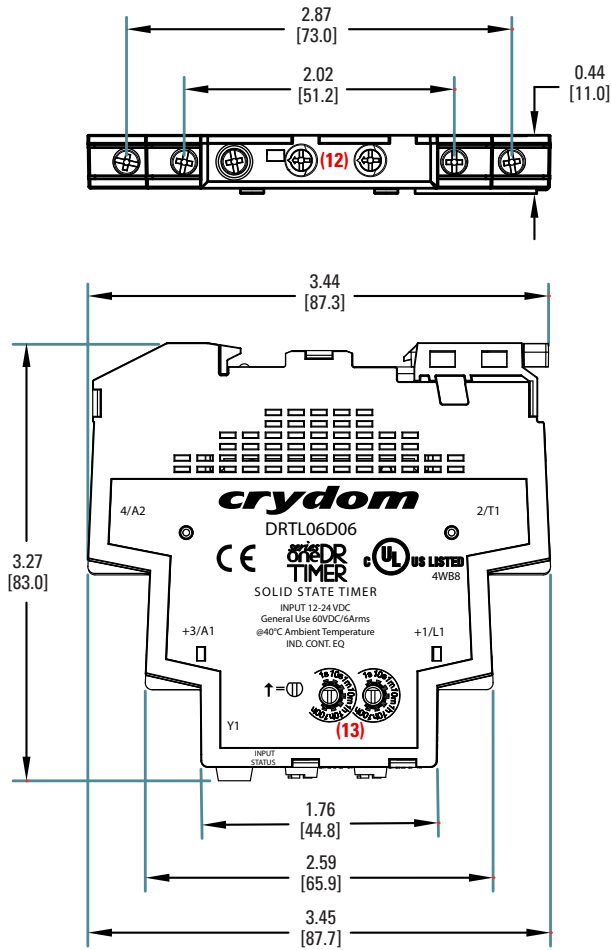

**THERMAL DERATE INFORMATION**



--- Installed single unit, distance to adjacent components ≥ 11 mm  
 — Multiple Units No Spacing

**LED STATUS FUNCTION**

LED Status by Function						
Function	Control Voltage	Y1	Timing	Output State	LED Status	Notes
<b>A/At</b> Delay On Make	Off	◆	Off	Off	Off	<p>At function is identical to the A function except when Y1 is connected to A1 timing is paused. When Y1 is removed timing resumes until relay times out. To reset timer remove control power.</p>
	On	◆	On	Off	Long Flashes	
	On	◆	Timed Out	On	On	
<b>H/Ht</b> Interval	Off	◆	Off	Off	Off	<p>Ht function is identical to the H function except when Y1 is connected to A1 timing is paused. When Y1 is removed timing resumes until relay times out. To reset timer remove control power.</p>
	On	◆	On	On	Long Flashes	
	On	◆	Timed Out	Off	Short Flashes	
<b>D/Di</b> Repeat Cycle	Off	◆	Off	Off	Off	<p>To select between on time (Di) first or off time (D) first Y1 is connected. Default is On time (Di) first, for Off time (D) first connect Y1. Equal On/Off time.</p>
	On	◆	On	On/Off	Long Flashes/Short Flashes	
<b>L/Li</b> Repeat Cycle	Off	◆	Off	Off	Off	<p>To select between on time (Li) first or off time (L) first Y1 is connected A1. Default is On time (Li) first, for Off time (L) first connect Y1 to A1. Time delay is independent of each other.</p>
	On	◆	On	On/Off	Long Flashes/Short Flashes	
<b>B</b> Single Shot	Off	Open	Off	Off	Off	<p>Y1 switch can be momentary or maintained to A1. To reset timer after relay has timed out Y1 has to be opened.</p>
	On	Open	Off	Off	Short Flashes	
	On	Closed	On	On	Long Flashes	
	On	Closed	Timed Out	Off	Short Flashes	
<b>C</b> Delay On Break	Off	Open	Off	Off	Off	<p>Y1 switch to A1 must be momentary for timing to begin. If during timing Y1 is closed again the time delay is reset and will begin again once Y1 is removed. Once timed out timer is reset and ready for the next cycle.</p>
	On	Open	Off	Off	Short Flashes	
	On	Closed	Off	On	On	
	On	Open	On	On	Long Flashes	
	On	Open	Timed Out	Off	Short Flashes	
<b>Ac</b> Delay On Make / Delay On Break	Off	Open	Off	Off	Off	<p>To start Delay on Make (A) timing connect Y1 to A1 and maintain until LED is on Solid then to start Delay on Break (c) portion remove Y1 until relay times out. Removing Y1 During (A) portion or Connecting Y1 during (c) portion will reset time for that portion.</p>
	On	Open	Off	Off	Short Flashes	
	On	Closed	On	Off	Long Flashes	
	On	Closed	Timed Out	On	On	
	On	Open	Timed Out	Off	Short Flashes	
<b>Bw</b>	Off	Open	Off	Off	Off	<p>Y1 to A1 switch can be momentary or maintained. If maintained until relay has timed out removing it will start timing again. If momentary and timers has timed out reapplying Y1 will start timing again.</p>
	On	Open	Off	Off	Short Flashes	
	On	Closed	On	On	Long Flashes	
	On	Closed	Timed Out	Off	Short Flashes	

**AGENCY APPROVALS**

Designed in accordance with the requirements of IEC 62314  
 IEC 60068-2-6 : Vibration 0.35mm and 0.75mm Amplitude over 10-55 Hz  
 IEC 60068-2-27 : Shock 15G/11ms  
 IEC 61000-4-2 : Electrostatic Discharge Level 3  
 IEC 61000-4-4 : Electrically Fast Transients Level 3  
 IEC 61000-4-5 : Electrical Surges Level 3



042517

**⚠ DANGER / PELIGRO / DANGER /GEFAHR / PERICOLO / 危險**

<p><b>HAZARD OF ELECTRIC SHOCK, EXPLOSION, OR ARC FLASH.</b></p> <ul style="list-style-type: none"> <li>• Disconnect all power before installing or working with this equipment.</li> <li>• Verify all connections and replace all covers before turning on power.</li> </ul> <p><b>Failure to follow these instructions will result in death or serious injury.</b></p>	<p><b>RIESGO DE DESCARGA ELECTRICA O EXPLOSION.</b></p> <ul style="list-style-type: none"> <li>• Desconectar todos los suministros de energia a este equipo antes de trabajar con este equipo.</li> <li>• Verificar todas las conexiones y colocar todas las tapas antes de energizar el equipo.</li> </ul> <p><b>El incumplimiento de estas instrucciones puede provocar la muerte o lesiones serias.</b></p>	<p><b>RISQUE DE DESCARGE ELECTRIQUE OU EXPLOSION</b></p> <ul style="list-style-type: none"> <li>• Eteindre toutes les sources d'énergie de cet appareil avant de travailler dessus de cet appareil</li> <li>• Vérifier tous connections, et remettre tous couverts en place avant de mettre sous</li> </ul> <p><b>De non-suivi de ces instructions provoquera la mort ou des lésions sérieuses.</b></p>	<p><b>GEFAHR EINES ELEKTRISCHE N SCHLAGES ODER EINER EXPLOSION.</b></p> <ul style="list-style-type: none"> <li>• Stellen Sie jeglichen Strom ab, der dieses Gerät versorgt, bevor Sie an dem Gerät Arbeiten durchführen</li> <li>• Vor dem Drehen auf Energie alle Anschlüsse überprüfen und alle Abdeckungen ersetzen.</li> </ul> <p><b>Unterlassung dieser Anweisungen können zum Tode oder zu schweren Verletzungen führen.</b></p>	<p><b>RISCHIO DI SCOSSA ELETTRICA O DELL'ESPLOSIONE.</b></p> <ul style="list-style-type: none"> <li>• Spenga tutta l'alimentazione che fornisce questa apparecchiatura prima di lavorare a questa apparecchiatura</li> <li>• Verificare tutti i collegamenti e sostituire tutte le coperture prima dell'accensione</li> </ul> <p><b>L'omissione di queste istruzioni provocherà la morte o lesioni serie</b></p>	<p><b>存在电击、爆炸或电弧闪烁危险</b></p> <ul style="list-style-type: none"> <li>• 在操作此设备之前请先关闭电源。</li> </ul> <p><b>若不遵守这些说明，可能会导致严重的人身伤害甚至死亡。</b></p>
--	--	---	--	--	---

**⚠ WARNING / AVERTISSEMENT / WARNUNG /ADVERTENCIA / AVVERTENZA / 警告**

<p><b>RISK OF MATERIAL DAMAGE AND HOT ENCLOSURE</b></p> <ul style="list-style-type: none"> <li>• The product's side panels may be hot, allow the product to cool before touching.</li> <li>• Follow proper mounting instructions including torque values.</li> <li>• Do not allow liquids or foreign objects to enter this product.</li> </ul> <p><b>Failure to follow these instructions can result in serious injury, or equipment damage.</b></p>	<p><b>RISQUE DE DOMMAGE MATERIEL ET DE SURCHAUFFE DU BOITIER</b></p> <ul style="list-style-type: none"> <li>• Les panneaux latéraux du produit peuvent être chauds. Laisser le produit refroidir avant de le toucher.</li> <li>• Respecter les consignes de montage, et notamment les couples de serrage.</li> <li>• Ne pas laisser pénétrer de liquide ni de corps étrangers à l'intérieur du produit.</li> </ul> <p><b>Le non-respect de cette directive peut entraîner, des lésions corporelles graves ou des dommages matériels.</b></p>	<p><b>GEFAHR VON MATERIALSCHÄDEN UND GEHÄUSEERHITZUNG</b></p> <ul style="list-style-type: none"> <li>• Die Seitenwände können heiß sein. Lassen Sie das Produkt abkühlen, bevor Sie es berühren.</li> <li>• Beachten Sie die Montageanweisungen, Führen Sie keine Flüssigkeiten oder Fremdkörper in das Produkt ein.</li> </ul> <p><b>Die Nichtbeachtung dieser Anweisung kann Körperverletzung oder Materialschäden zur Folge haben.</b></p>
<p><b>RIESGO DE DAÑOS MATERIALES Y DE SOBRECIENTAMIENTO DE LA UNIDAD</b></p> <ul style="list-style-type: none"> <li>• Los paneles laterales del producto pueden estar calientes. Esperar que el producto se enfríe antes de tocarlo.</li> <li>• Respetar las instrucciones de montaje, y en particular los pares de apretado.</li> <li>• No dejar que penetren líquidos o cuerpos extraños en el producto.</li> </ul> <p><b>Si no se respetan estas precauciones pueden producirse graves lesiones, daños materiales.</b></p>	<p><b>RISCHIO DI DANNI MATERIALI E D'INVOLUCRO CALDO</b></p> <ul style="list-style-type: none"> <li>• I pannelli laterali dell'apparecchio possono scottare; lasciar quindi raffreddare il prodotto prima di toccarlo.</li> <li>• Seguire le istruzioni di montaggio corrette.</li> <li>• Non far entrare liquidi o oggetti estranei in questo apparecchio.</li> </ul> <p><b>La mancata osservanza di questa precauzione può causare gravi rischi per l'incolumità personale o danni alle apparecchiature.</b></p>	<p><b>材料损坏和高温外壳的危险性</b></p> <ul style="list-style-type: none"> <li>• 产品的一侧面板可能很热，在其冷却前请不要触碰。</li> <li>• 遵照正确的安装说明，包括扭矩值。</li> <li>• 请勿让液体及其他异物进入本产品。</li> </ul> <p><b>如不能正确执行这些操作说明，极有可能造成严重人体伤害或者设备的损坏。</b></p>

**ANNEX - ENVIROMENTAL INFORMATION**

The environmental information disclosed in this annex including the EIP Pollution logo are in compliance with People’s Republic of China Electronic Industry Standard SJ/T11364 – 2006, Marking for Control of Pollution Caused by Electronic Information Products.

Part Name	Toxic or hazardous Substance and Elements					
	Lead (Pb)	Mercury (Hg)	Cadmium (Cd)	Hexavalent Chromium (Cr (VI))	Polybrominated biphenyls (PBB)	Polybrominated diphenyl ethers (PBDE)
Semiconductor die	X	O	O	O	O	O
Solder	X	O	O	O	O	O

附件 – 环保信息

此附件所标示的包括电子信息产品污染图标的环保信息符合中华人民共和国电子行业标准 SJ/T 11364 - 2006, 电子信息产品污染控制标识要求。

部件名称	有毒有害物质或元素					
	铅 (Pb)	汞 (Hg)	镉 (Cd)	六价铬 (Cr (VI))	多溴联苯 (PBB)	多溴二苯醚 (PBDE)
半导体芯片	X	O	O	O	O	O
焊接点	X	O	O	O	O	O





Компания «ЭлектроПласт» предлагает заключение долгосрочных отношений при поставках импортных электронных компонентов на взаимовыгодных условиях!

Наши преимущества:

- Оперативные поставки широкого спектра электронных компонентов отечественного и импортного производства напрямую от производителей и с крупнейших мировых складов;
- Поставка более 17-ти миллионов наименований электронных компонентов;
- Поставка сложных, дефицитных, либо снятых с производства позиций;
- Оперативные сроки поставки под заказ (от 5 рабочих дней);
- Экспресс доставка в любую точку России;
- Техническая поддержка проекта, помощь в подборе аналогов, поставка прототипов;
- Система менеджмента качества сертифицирована по Международному стандарту ISO 9001;
- Лицензия ФСБ на осуществление работ с использованием сведений, составляющих государственную тайну;
- Поставка специализированных компонентов (Xilinx, Altera, Analog Devices, Intersil, Interpoint, Microsemi, Aeroflex, Peregrine, Syfer, Eurofarad, Texas Instrument, Miteq, Cobham, E2V, MA-COM, Hittite, Mini-Circuits, General Dynamics и др.);

Помимо этого, одним из направлений компании «ЭлектроПласт» является направление «Источники питания». Мы предлагаем Вам помощь Конструкторского отдела:

- Подбор оптимального решения, техническое обоснование при выборе компонента;
- Подбор аналогов;
- Консультации по применению компонента;
- Поставка образцов и прототипов;
- Техническая поддержка проекта;
- Защита от снятия компонента с производства.



#### Как с нами связаться

**Телефон:** 8 (812) 309 58 32 (многоканальный)

**Факс:** 8 (812) 320-02-42

**Электронная почта:** [org@eplast1.ru](mailto:org@eplast1.ru)

**Адрес:** 198099, г. Санкт-Петербург, ул. Калинина, дом 2, корпус 4, литера А.