

SiT9001

High Performance Spread Spectrum Oscillator



Features

- Frequency range from 1 MHz to 200 MHz
- Center Spread Modulation: $\pm 0.25\%$, $\pm 0.5\%$, $\pm 1\%$
- Down Spread Modulation: -0.5% , -1% , -2% ; spread disable option available
- Power down or output enable option available
- Frequency stability: ± 25 ppm, ± 50 ppm and ± 100 ppm (Spread = OFF)
- Operating voltage: 1.8V or 2.5 or 3.3 V; other voltages up to 3.63 V (contact SiTime)
- Operating temperature range: Industrial, -40°C to $+85^{\circ}\text{C}$, Extended Commercial, -20°C to $+70^{\circ}\text{C}$
- Industry-standard packages: 2.5 x 2.0, 3.2 x 2.5, 5.0 x 3.2, 7.0 x 5.0 mm x mm
- Pb-free, RoHS and REACH compliant
- High drive option: 30pF load (contact factory)
- 30 ps Ultra-low cycle-to-cycle jitter

Applications

- Set-top boxes and LCD displays
- Scanners, printers and copiers
- Interface controllers and graphics cards
- PCI, CPU and memory buses
- Routers and modems



DC Electrical Characteristics

Parameters	Symbol	Min.	Typ.	Max.	Unit	Condition
Vdd = 3.3V $\pm 10\%$, -40°C to 85°C						
Output Voltage High	VOH	90	–	–	%Vdd	IOH = -9 mA
Output Voltage Low	VOL	–	–	10	%Vdd	IOL = 9 mA
Input Voltage High	VIH	70	–	–	%Vdd	Pin 1
Input Voltage Low	VIL	–	–	30	%Vdd	Pin 1
Operating Current	I _{dd}	–	–	27	mA	Output frequency = 30 MHz, 15 pF load
		–	–	34	mA	Output frequency = 125 MHz, 15 pF load
Standby Current	I _{std}	–	30	50	μA	Output is weakly pulled down, ST = GND
Power Up Time		–	–	10	ms	Time from minimum power supply voltage to the first cycle (Guaranteed no runt pulses)
Vdd = 2.5V $\pm 10\%$, -40°C to 85°C						
Output Voltage High	VOH	90	–	–	%Vdd	IOH = -7 mA
Output Voltage Low	VOL	–	–	10	%Vdd	IOL = 7 mA
Input Voltage High	VIH	70	–	–	%Vdd	Pin 1
Input Voltage Low	VIL	–	–	30	%Vdd	Pin 1
Operating Current	I _{dd}	–	–	26	mA	Output frequency = 30 MHz, 15 pF load
		–	–	31	mA	Output frequency = 125 MHz, 15 pF load
Standby Current	I _{std}	–	30	50	μA	Output is weakly pulled down, ST = GND
Power Up Time		–	–	10	ms	Time from minimum power supply voltage to the first cycle (Guaranteed no runt pulses)
Vdd = 1.8V $\pm 5\%$, -40°C to 85°C						
Output Voltage High	VOH	90	–	–	%Vdd	IOH = -5 mA
Output Voltage Low	VOL	–	–	10	%Vdd	IOL = 5mA
Input Voltage High	VIH	70	–	–	%Vdd	Pin 1
Input Voltage Low	VIL	–	–	30	%Vdd	Pin 1
Operating Current	I _{dd}	–	–	26	mA	Output frequency = 30 MHz, 15 pF load
		–	–	31	mA	Output frequency = 125 MHz, 15 pF load
Standby Current	I _{std}	–	30	50	μA	Output is weakly pulled down, ST = GND
Power Up Time		–	–	10	ms	Time from minimum power supply voltage to the first cycle (Guaranteed no runt pulses)

AC Electrical Characteristics

Parameters	Symbol	Min.	Typ.	Max.	Unit	Condition
Vdd = 3.3V ±10%, -40°C to 85°C						
Clock Output Frequency	Fout	1	–	200	MHz	
Clock Output Duty Cycle	DC	45	50	55	%	Output frequency = 1 MHz to 75 MHz
		40	–	60	%	Output frequency = 75 MHz to 200 MHz
Clock Output Rise Time	tr	–	1.0	1.5	ns	15 pF Load, 20% to 80% Vdd
Clock Output Fall Time	tf	–	1.0	1.5	ns	15 pF Load, 80% to 20% Vdd
Cycle-to-cycle Jitter	Tccj	–	22	29	ps	Spread = OFF, Output frequency = 133.33 MHz
		–	22	29	ps	Spread = ON, Output frequency = 133.33 MHz 2% down spread
Vdd = 2.5V ±10%, -40°C to 85°C						
Clock Output Frequency	Fout	1	–	200	MHz	
Clock Output Duty Cycle	DC	45	50	55	%	Output frequency = 1 MHz to 125 MHz
		40	–	60	%	Output frequency = 125 MHz to 200 MHz
Clock Output Rise Time	tr	–	1.0	1.5	ns	15 pF Load, 20% to 80% Vdd
Clock Output Fall Time	tf	–	1.0	1.5	ns	15 pF Load, 80% to 20% Vdd
Cycle-to-cycle Jitter	Tccj	–	26	37	ps	Spread = OFF, Output frequency = 133.33 MHz
		–	26	37	ps	Spread = ON, Output frequency = 133.33 MHz 2% down spread
Vdd = 1.8V ±5%, -40°C to 85°C						
Clock Output Frequency	Fout	1	–	200	MHz	
Clock Output Duty Cycle	DC	45	50	55	%	Output frequency = 1 MHz to 75 MHz
		40	–	60	%	Output frequency = 75 MHz to 200 MHz
Clock Output Rise Time	tr	–	1.0	1.5	ns	15 pF Load, 20% to 80% Vdd
Clock Output Fall Time	tf	–	1.0	1.5	ns	15 pF Load, 80% to 20% Vdd
Cycle-to-cycle Jitter	Tccj	–	45	57	ps	Spread = OFF, Output frequency = 133.33 MHz
		–	45	57	ps	Spread = ON, Output frequency = 133.33 MHz 2% down spread

Pin Configuration

Pin	Symbol		Functionality
1	$\overline{\text{ST/OE/SD}}$	Standby	H or Open ^[1] : specified frequency output L: output is low (weak pull down). Oscillator stops
		Output Enable	H or Open ^[1] : specified frequency output L: output is high impedance. Standby/ Output Enable/ Spread Disable.
		SD (Down Spread) only	H or Open: Spread = ON L: Spread =OFF
2	GND	Power	Connect to Ground
3	SS_OUT	Output	1 to 200 MHz Spread Spectrum Clock Output
4	VDD		Connect to 1.8V or 2.5V or 3.3V



Note:

1. A pull-up resistor of <10 kΩ between $\overline{\text{ST/OE/SD}}$ pin and Vdd is recommended in high noise environment.

Block Diagram

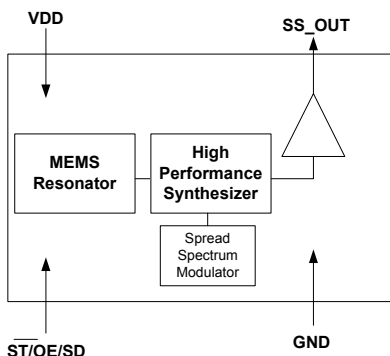

Absolute Maximum

Attempted operation outside the absolute maximum ratings of the part may cause permanent damage to the part. Actual performance of the IC is only guaranteed within the operational specifications, not at absolute maximum ratings.

Parameters	Min.	Max.	Unit
Storage Temperature	-65	150	°C
VDD	-0.5	+3.66	V
Electrostatic Discharge	–	2000	V
Theta JA (with copper plane on VDD and GND)	–	75	°C/W
Theta JC (with PCB traces of 0.010 inch to all pins)	–	24	°C/W
Soldering Temperature (follow standard Pb free soldering guidelines)	–	260	°C
Number of Program Writes	–	1	NA
Program Retention over -40 to 125C, Process, VDD (0 to 3.65V)	–	1,000+	years

Operating Conditions

Parameters	Min.	Typ.	Max.	Unit
Supply Voltages, VDD ^[2]	2.97	3.3	3.63	V
	2.25	2.5	2.75	V
	1.7	1.8	1.9	V
Frequency Stability, Spread = OFF (down spread only) (Inclusive of Initial stability, operating temperature, rated power supply voltage change, load change, aging (1 ppm first year @ 25°C), shock and vibration)	-50	–	+50	ppm
	-100	–	+100	ppm
Extended Commercial Operating Temperature	-20	–	70	°C
Industrial Operating Temperature	-40	–	85	°C
Maximum Load Capacitance ^[3]	–	–	15	pF

Notes:

- The 3.3V device can operate from 2.25V to 3.63V with higher output drive strength, however, the data sheet specifications cannot be guaranteed. Please contact factory for this option.
- The output driver strength can be programmed to drive up to 30 pF load. Please contact factory for this option.

Thermal Considerations

Package	θJA, 4 Layer Board (°C/W)	θJA, 2 Layer Board (°C/W)	θJC, Bottom (°C/W)
7050	191	263	30
5032	97	199	24
3225	109	212	27
2520	117	222	26

Environmental Compliance

Parameter	Condition/Test Method
Mechanical Shock	MIL-STD-883F, Method 2002
Mechanical Vibration	MIL-STD-883F, Method 2007
Temperature Cycle	JESD22, Method A104
Solderability	MIL-STD-883F, Method 2003
Moisture Sensibility Level	MSL1 @ 260°C

SiT9001

High Performance Spread Spectrum Oscillator

Description

The SiT9001 is a spread-spectrum capable, programmable MEMS oscillator. The SiT9001 offers unparalleled flexibility in terms of frequency range, frequency accuracy stability, supply voltage, and operating temperature range while simultaneously offering outstanding performance in terms of low jitter and a higher frequency range. This flexibility and high performance is made available in packages down to 2.5 x 2.0 mm, making the SiT9001 the smallest programmable spread-spectrum oscillator available.

The SiT9001 is factory programmable and offers two types of spread modulation: down spread modulation, and center

spread modulation. In down spread modulation mode, a spread disable pin is available (Pin 1).

Power down (either output enable or standby) mode options are available for both down spread and center spread versions of the SiT9001.

The SiT9001, by eliminating the quartz crystal, has improved immunity, shock, strain and humidity.

To order samples, go to www.sitime.com and click on Request Sample” link.

Spread Spectrum Modes^[4]

Center Spread	Code	1	2	3
	Down Spread	Down Spread	Down Spread	Down Spread
Down Spread	Code	4	5	6
	Down Spread	Down Spread	Down Spread	Down Spread

Note:

- In both modes, triangle modulation is employed with a frequency of ~32 kHz.

Down Spread: -2%



Down Spread: -1%

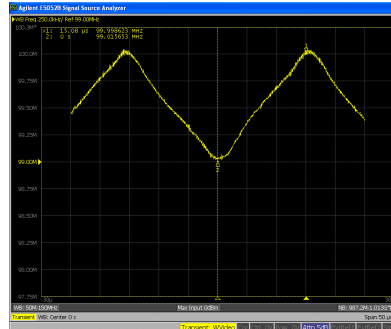

Down Spread: -0.5%

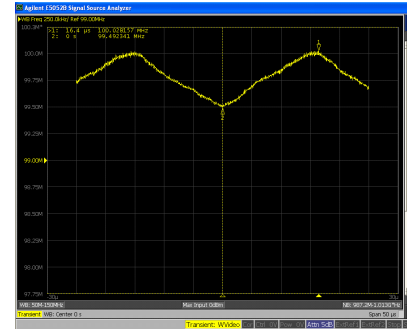

The SiT9001 can be factory programmed to provide down spread modulation or center spread modulation. In the down spread modulation mode, pin 1 can be factory programmed as a spread disable pin. In both the down spread and center spread modulation modes, pin can be factory programmed to be either output enable or standby.

Programmable Drive Strength

The SiT9001 includes a programmable drive strength feature to provide a simple, flexible tool to optimize the clock rise/fall time for specific applications. Benefits from the programmable drive strength feature are:

- Improves system radiated electromagnetic interference (EMI) by slowing down the clock rise/fall time
- Improves the downstream clock receiver's (RX) jitter by decreasing (speeding up) the clock rise/fall time.
- Ability to drive large capacitive loads while maintaining full swing with sharp edge rates.

For more detailed information about rise/fall time control and drive strength selection, see the SiTime Applications Note section; <http://www.sitime.com/support/application-notes>.

EMI Reduction by Slowing Rise/Fall Time

Figure 1 shows the harmonic power reduction as the rise/fall times are increased (slowed down). The rise/fall times are expressed as a ratio of the clock period. For the ratio of 0.05, the signal is very close to a square wave. For the ratio of 0.45, the rise/fall times are very close to near-triangular waveform. These results, for example, show that the 11th clock harmonic can be reduced by 35 dB if the rise/fall edge is increased from 5% of the period to 45% of the period.

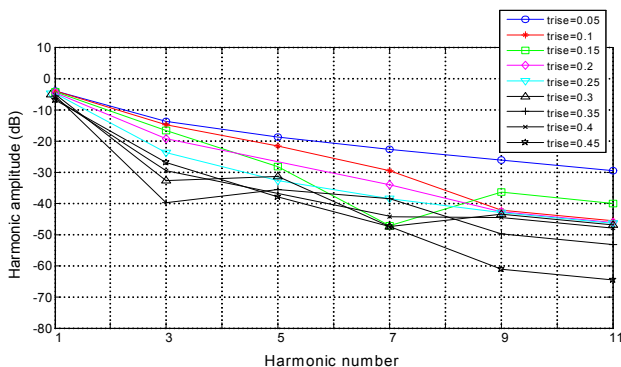

Figure 1. Harmonic EMI reduction as a Function of Slower Rise/Fall Time

Jitter Reduction with Faster Rise/Fall Time

Power supply noise can be a source of jitter for the downstream chipset. One way to reduce this jitter is to increase rise/fall time (edge rate) of the input clock. Some chipsets would require faster rise/fall time in order to reduce their sensitivity to this type of jitter. The SiT9001 provides up to 3 additional high drive strength settings for very fast rise/fall time. Refer to the [Drive Strength Settings Table](#) to determine the proper drive strength.

High Output Load Capability

The rise/fall time of the input clock varies as a function of the actual capacitive load the clock drives. At any given drive

strength, the rise/fall time becomes slower as the output load increases. As an example, for a 3.3V SiT9001 device with default drive strength setting, the typical rise/fall time is 1ns for 15 pF output load. The typical rise/fall time slows down to 2.6ns when the output load increases to 45 pF. One can choose to speed up the rise/fall time to 1.68ns by then increasing the drive strength setting on the SiT9001.

The SiT9001 can support up to 60 pF or higher in maximum capacitive loads with up to 3 additional drive strength settings. Refer to the [Drive Strength Settings Table](#) to determine the proper drive strength for the desired combination of output load vs. rise/fall time

SiT9001 Drive Strength Selection

The Drive Strength Settings Table define the rise/fall time for a given capacitive load and supply voltage.

1. Select the table that matches the SiT9001 nominal supply voltage (1.8V, 2.5V, 2.8V, 3.0V, 3.3V).
2. Select the capacitive load column that matches the application requirement (5 pF to 60 pF)
3. Under the capacitive load column, select the desired rise/fall times.
4. The left-most column represents the part number code for the corresponding drive strength.
5. Add the drive strength code to the part number for ordering purposes.

Calculating Maximum Frequency

Based on the rise and fall time data given in Tables 1 through 4, the maximum frequency the oscillator can operate with guaranteed full swing of the output voltage over temperature as follows:

$$\text{Max Frequency} = \frac{1}{5 \times \text{Trf}_{20/80}}$$

Where Trf_{20/80} is the typical rise/fall time at 20% to 80% V_{dd}

Example 1

Calculate f_{MAX} for the following condition:

- V_{dd} = 1.8V
- Capacitive Load: 30 pF
- Desired Tr/f time = 3 ns (rise/fall time part number code = E)

Part number for the above example:

SiT9001AIE14-33E6-123.12345



Drive strength code is inserted here. Default setting is “-”

Drive Strength Settings

Drive Strength	Designator	SiT9001		
		1.8V	2.5V	3.3V
1X	L	-	-	-
3X	R	-	-	-
5X	S	-	-	X
7X	T	-	X	-
9X	U	X	-	-
11X	W	-	-	-
13X	X	-	-	-
15X	Y	-	-	-
17X	Z	x	x	x
21X	H	x	x	x

Legend:

X = Default Drive Strength

- = Valid Drive Strength Setting

x = Invalid Drive Strength Setting

Dimensions and Patterns

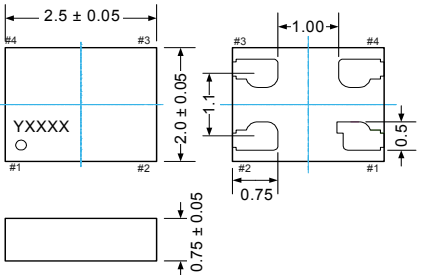
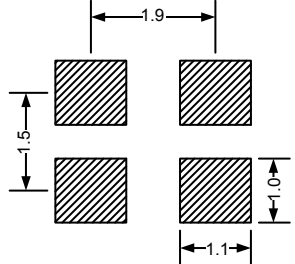
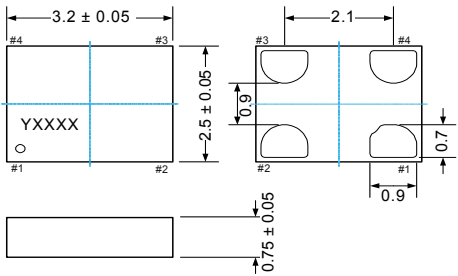
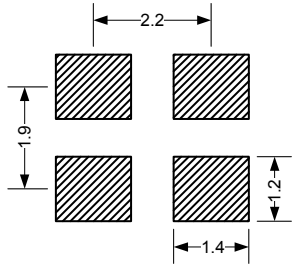
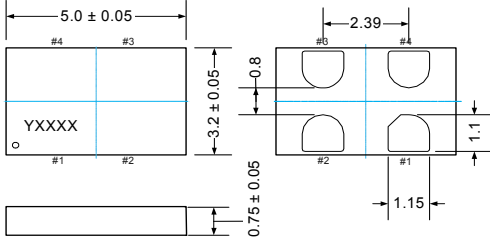
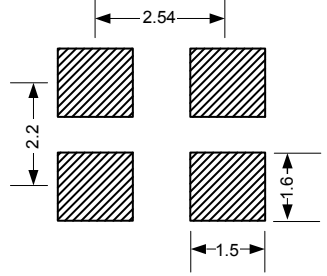
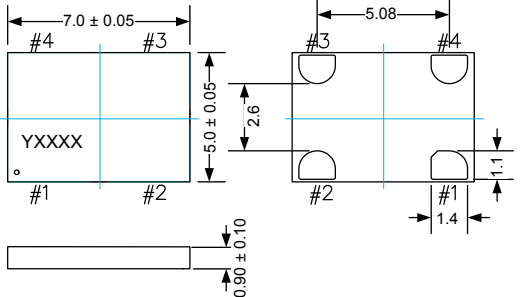
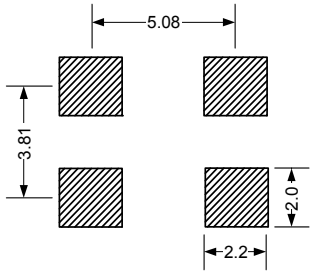
Package Size – Dimensions (Unit: mm) ^[5]	Recommended Land Pattern (Unit: mm) ^[6]
<p>2.5 x 2.0 x 0.75 mm</p> 	
<p>3.2 x 2.5 x 0.75 mm</p> 	
<p>5.0 x 3.2 x 0.75 mm</p> 	
<p>7.0 x 5.0 x 0.90 mm (without center-pad)</p> 	

Notes:

5. Top marking: Y denotes manufacturing origin and XXXX denotes manufacturing lot number. The value of “Y” will depend on the assembly location of the device.
6. A capacitor of value 0.1 μ F between Vdd and GND is required.

Dimensions and Patterns

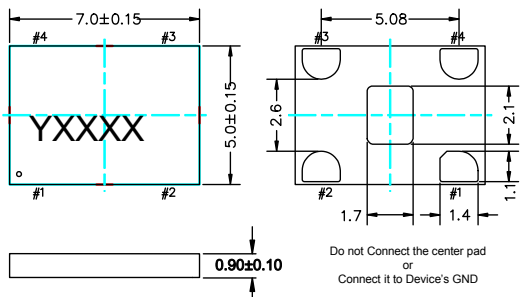
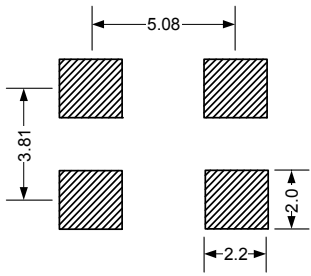
Package Size – Dimensions (Unit: mm) ^[5]	Recommended Land Pattern (Unit: mm) ^[6]
<p>7.0 x 5.0 x 0.90 mm (with Center-Pad)</p>  <p>Do not Connect the center pad or Connect it to Device's GND</p>	

Notes:

- 5. Top marking: Y denotes manufacturing origin and XXXX denotes manufacturing lot number. The value of "Y" will depend on the assembly location of the device.
- 6. A capacitor of value 0.1 μ F between Vdd and GND is required.

Ordering Information

The Part No. Guide is for reference only. To customize and build an exact part number, use the SiTime [Part Number Generator](#).

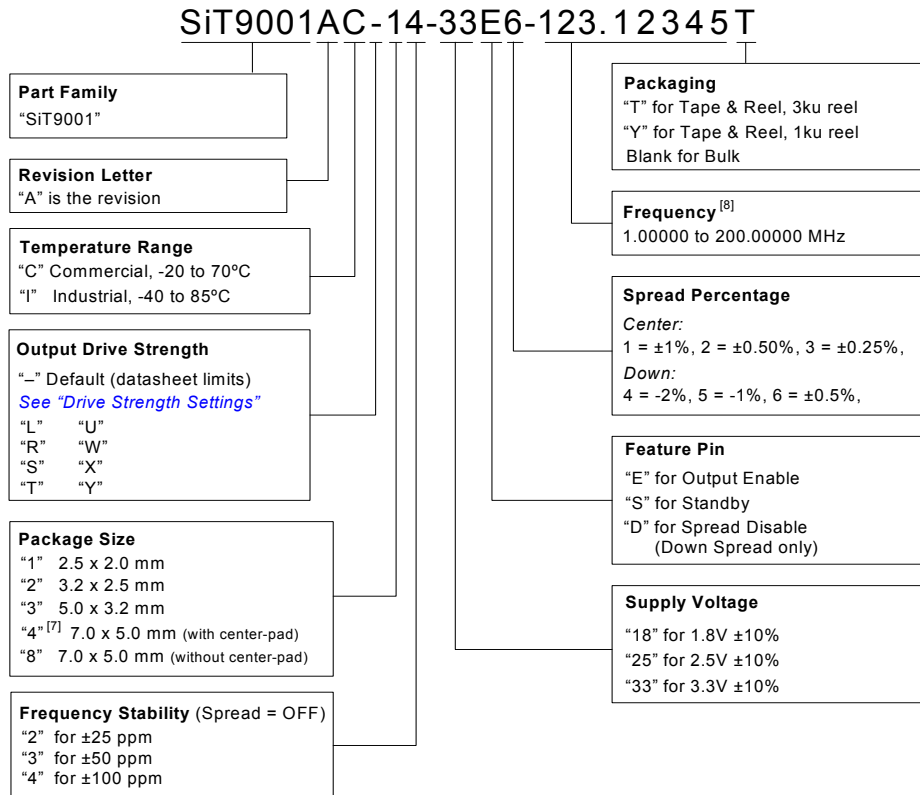

Notes:

- 7. Not recommended for new designs. Please use "8".
- 8. Please refer to 'Part Number Generator' of 9001 (9001 product page on SiTime.com) to check for details on supported frequencies. http://www.sitime.com/products/spread-spectrum/sit9001#magictabs_JdxGM_3

Revision History

Version	Release Date	Change Summary
1.09	8/2013	Initial Release
1.10	4/1/14	• Added a note to clarify frequency support in ordering information
1.2	9/17/14	• Included ±25 ppm support

© SiTime Corporation 2014. The information contained herein is subject to change at any time without notice. SiTime assumes no responsibility or liability for any loss, damage or defect of a Product which is caused in whole or in part by (i) use of any circuitry other than circuitry embodied in a SiTime product, (ii) misuse or abuse including static discharge, neglect or accident, (iii) unauthorized modification or repairs which have been soldered or altered during assembly and are not capable of being tested by SiTime under its normal test conditions, or (iv) improper installation, storage, handling, warehousing or transportation, or (v) being subjected to unusual physical, thermal, or electrical stress.

Disclaimer: SiTime makes no warranty of any kind, express or implied, with regard to this material, and specifically disclaims any and all express or implied warranties, either in fact or by operation of law, statutory or otherwise, including the implied warranties of merchantability and fitness for use or a particular purpose, and any implied warranty arising from course of dealing or usage of trade, as well as any common-law duties relating to accuracy or lack of negligence, with respect to this material, any SiTime product and any product documentation. Products sold by SiTime are not suitable or intended to be used in a life support application or component, to operate nuclear facilities, or in other mission critical applications where human life may be involved or at stake. All sales are made conditioned upon compliance with the critical uses policy set forth below.

CRITICAL USE EXCLUSION POLICY
BUYER AGREES NOT TO USE SITIME'S PRODUCTS FOR ANY APPLICATION OR IN ANY COMPONENTS USED IN LIFE SUPPORT DEVICES OR TO OPERATE NUCLEAR FACILITIES OR FOR USE IN OTHER MISSION-CRITICAL APPLICATIONS OR COMPONENTS WHERE HUMAN LIFE OR PROPERTY MAY BE AT STAKE.

SiTime owns all rights, title and interest to the intellectual property related to SiTime's products, including any software, firmware, copyright, patent, or trademark. The sale of SiTime products does not convey or imply any license under patent or other rights. SiTime retains the copyright and trademark rights in all documents, catalogs and plans supplied pursuant to or ancillary to the sale of products or services by SiTime. Unless otherwise agreed to in writing by SiTime, any reproduction, modification, translation, compilation, or representation of this material shall be strictly prohibited.



Компания «ЭлектроПласт» предлагает заключение долгосрочных отношений при поставках импортных электронных компонентов на взаимовыгодных условиях!

Наши преимущества:

- Оперативные поставки широкого спектра электронных компонентов отечественного и импортного производства напрямую от производителей и с крупнейших мировых складов;
- Поставка более 17-ти миллионов наименований электронных компонентов;
- Поставка сложных, дефицитных, либо снятых с производства позиций;
- Оперативные сроки поставки под заказ (от 5 рабочих дней);
- Экспресс доставка в любую точку России;
- Техническая поддержка проекта, помощь в подборе аналогов, поставка прототипов;
- Система менеджмента качества сертифицирована по Международному стандарту ISO 9001;
- Лицензия ФСБ на осуществление работ с использованием сведений, составляющих государственную тайну;
- Поставка специализированных компонентов (Xilinx, Altera, Analog Devices, Intersil, Interpoint, Microsemi, Aeroflex, Peregrine, Syfer, Eurofarad, Texas Instrument, Miteq, Cobham, E2V, MA-COM, Hittite, Mini-Circuits, General Dynamics и др.);

Помимо этого, одним из направлений компании «ЭлектроПласт» является направление «Источники питания». Мы предлагаем Вам помощь Конструкторского отдела:

- Подбор оптимального решения, техническое обоснование при выборе компонента;
- Подбор аналогов;
- Консультации по применению компонента;
- Поставка образцов и прототипов;
- Техническая поддержка проекта;
- Защита от снятия компонента с производства.



Как с нами связаться

Телефон: 8 (812) 309 58 32 (многоканальный)

Факс: 8 (812) 320-02-42

Электронная почта: org@eplast1.ru

Адрес: 198099, г. Санкт-Петербург, ул. Калинина, дом 2, корпус 4, литера А.