



## SINGLE CHIP PC AUDIO SYSTEM CODEC+SPEAKER AMPLIFIER+CAPLESS HP+LDO

# 92HD81

### Description

The 92HD81 single-chip audio system is a low power optimized, high fidelity, 4-channel audio codec with integrated speaker amplifier, capless headphone amplifier, and low drop out voltage regulator.

The high integration of the 92HD81 enables the smallest PCB footprint with the lowest system BOM count and cost.

The integrated high-pass filter allows for speaker protection.

The 92HD81 provides high quality HD Audio capability to notebook and business desktop PC applications.

### Features

- **4 Channels (2 stereo DACs and 2 stereo ADCs) with 24-bit resolution**
  - Supports full-duplex stereo audio and simultaneous VoIP
  - Provides a mono output
- **2W/channel stereo speaker amplifier @ 4 ohms and 4.75V**
- **Two headphone amplifiers**
  - One capless and one non-capless retaskable
- **Internal core voltage regulator**
  - 1.5V to 1.8V or 3.3V digital power supply options
- **+5 V analog power supply option**
- **Dedicated BTL high pass filter for speaker protection (RA revision only)**
- **Full HDA015-B low power support**
  - Audio inactivity transitions codec from D0 to D3 low power mode
  - Resume from D3 to D0 with audio activity in < 10 msec
  - D3 to D0 transition with < -65dB pop/click
  - Port presence detect in D3 with or without bit clock
  - Optional analog PC beep in D3
  - Additional vendor specific modes for even lower power
- **Microsoft WLP 3/4/5 premium logo compliant, as defined in WLP 3.9**
- **Dual SPDIF for WLP compliant support of simultaneous HDMI and SPDIF output**
- **Support for 1.5V and 3.3V HDA signaling**
- **Two digital microphone inputs (mono, stereo, or quad microphones)**
- **High performance analog mixer**
- **2 adjustable VREF Out pins for analog microphone bias**
- **6 analog ports with port presence detect (5 single ended, 1 BTL)**
- **Analog and digital PC Beep support**
- **Aux Audio Mode** (see orderable part numbers for support)
- **48-pad QFN RoHS packages**

## Software Support

- Intuitive TSI HD Sound graphical user interface that allows configurability and preference settings
- 12 band fully parametric equalizer
  - Constant, system-level effects tuned to optimize a particular platform can be combined with user-mode “presets” tailored for specific acoustical environments and applications
  - System-level effects automatically disabled when external audio connections made
- Dynamics Processing
  - Enables improved voice articulation
  - Compressor/limiter allows higher average volume level without resonances or damage to speakers.
- TSI Vista APO wrapper
  - Enables multiple APOs to be used with the TSI Driver
- Microphone Beam Forming, Acoustic Echo Cancellation, and Noise Suppression
- Dynamic Stream Switching
  - Improved multi-streaming user experience with less support calls
- Broad 3<sup>rd</sup> party branded software including Creative, Dolby, DTS, and SRS

**TABLE OF CONTENTS**

**DESCRIPTION ..... 11**

- Overview ..... 11
- Orderable Part Numbers ..... 11

**DETAILED DESCRIPTION ..... 12**

- Port Functionality ..... 12
  - Port Characteristics ..... 13
  - Vref\_Out ..... 13
  - Jack Detect ..... 13
  - SPDIF Output ..... 14
- Mono Output ..... 17
- Analog Mixer ..... 17
- ADC Multiplexers ..... 17
- Power Management ..... 17
- AFG D0 ..... 18
- AFG D1 ..... 19
- AFG D2 ..... 19
- AFG D3 ..... 19
  - AFG D3cold ..... 19
- Vendor Specific Function Group Power States D4/D5 ..... 20
- Low-voltage HDA Signaling ..... 20
- Multi-channel capture ..... 20
- Digital Microphone Support ..... 22
- Analog PC-Beep ..... 27
- Digital PC-Beep ..... 27
- Headphone Drivers ..... 27
- EAPD ..... 28
- BTL Amplifier ..... 31
- BTL Amplifier High-Pass Filter ..... 31
  - Filter Description ..... 31
- GPIO ..... 32
  - GPIO Pin mapping and shared functions ..... 32
  - SPDIF/Digital Microphone/GPIO Selection ..... 32
  - Digital Microphone/GPIO Selection ..... 32
- HD Audio HDA015-B support ..... 33
- Digital Core Voltage Regulator ..... 33
- Aux Audio Support ..... 34
  - General conditions in Aux Audio Mode: ..... 34
  - “Playback Path” Port Behavior ..... 34
  - “Record Path” Port Behavior ..... 36
  - EAPD ..... 37
  - Analog PC\_Beep ..... 37
  - Firmware/Software Requirements: ..... 37

**CHARACTERISTICS ..... 38**

- Electrical Specifications ..... 38
  - Absolute Maximum Ratings ..... 38
  - Recommended Operating Conditions ..... 38
- 92HD81 Analog Performance Characteristics ..... 39
- AC Timing Specs ..... 43
  - HD Audio Bus Timing ..... 43
  - SPDIF Timing ..... 44
  - Digital Microphone Timing ..... 44
    - Class-AB BTL Amplifier Performance ..... 44
    - Capless Headphone Supply Characteristics ..... 45

**FUNCTIONAL BLOCK DIAGRAMS ..... 46**

**WIDGET INFORMATION AND SUPPORTED COMMAND VERBS ..... 47**

**PORT CONFIGURATIONS ..... 48**

- Suggested Desktop Configurations ..... 48

Suggested Mobile Port Configurations .....	49
Pin Configuration Default Register Settings .....	50
<b>WIDGET INFORMATION .....</b>	<b>51</b>
Widget List .....	51
Reset Key .....	53
Root (NID = 00h): VendorID .....	53
Root (NID = 00h): RevID .....	54
Root (NID = 00h): NodeInfo .....	54
AFG (NID = 01h): NodeInfo .....	55
AFG (NID = 01h): FGType .....	55
AFG (NID = 01h): AFGCap .....	56
AFG (NID = 01h): PCMCap .....	57
AFG (NID = 01h): StreamCap .....	58
AFG (NID = 01h): InAmpCap .....	59
AFG (NID = 01h): PwrStateCap .....	60
AFG (NID = 01h): GPIOCnt .....	61
AFG (NID = 01h): OutAmpCap .....	61
AFG (NID = 01h): PwrState .....	62
AFG (NID = 01h): UnsolResp .....	63
AFG (NID = 01h): GPIO .....	63
AFG (NID = 01h): GPIOEn .....	64
AFG (NID = 01h): GPIODir .....	65
AFG (NID = 01h): GPIOWakeEn .....	65
AFG (NID = 01h): GPIOUnsol .....	66
AFG (NID = 01h): GPIOSticky .....	66
AFG (NID = 01h): SubID .....	67
AFG (NID = 01h): GPIOIrty .....	68
AFG (NID = 01h): GPIODrive .....	68
AFG (NID = 01h): DMic .....	69
AFG (NID = 01h): DACMode .....	70
AFG (NID = 01h): ADCMode .....	71
AFG (NID = 01h): EAPD .....	71
AFG (NID = 01h): PortUse .....	73
AFG (NID = 01h): VSPwrState .....	74
AFG (NID = 01h): AnaPort .....	75
AFG (NID = 01h): AnaBeep .....	76
AFG (NID = 01h): AnaBTL YC and YD Revisions .....	76
AFG (NID = 01h): AnaBTL UA,TA, RA Revisions .....	78
AFG (NID = 01h): AnaCapless .....	81
AFG (NID = 01h): Reset .....	84
AFG (NID = 01h): AuxAudio .....	84
PortA (NID = 0Ah): WCap .....	85
PortA (NID = 0Ah): PinCap .....	86
PortA (NID = 0Ah): ConLst .....	87
PortA (NID = 0Ah): ConLstEntry0 .....	88
PortA (NID = 0Ah): InAmpLeft .....	88
PortA (NID = 0Ah): InAmpRight .....	89
PortA (NID = 0Ah): ConSelectCtrl .....	89
PortA (NID = 0Ah): PwrState .....	90
PortA (NID = 0Ah): PinWCntrl .....	90
PortA (NID = 0Ah): UnsolResp .....	91
PortA (NID = 0Ah): ChSense .....	92
PortA (NID = 0Ah): EAPDBTLR .....	92
PortA (NID = 0Ah): ConfigDefault .....	93
PortB (NID = 0Bh): WCap .....	95
PortB (NID = 0Bh): PinCap .....	97
PortB (NID = 0Bh): ConLst .....	98
PortB (NID = 0Bh): ConLstEntry0 .....	99
PortB (NID = 0Bh): ConSelectCtrl .....	99

PortB (NID = 0Bh): PwrState .....	99
PortB (NID = 0Bh): PinWCntrl .....	100
PortB (NID = 0Bh): UnsolResp .....	101
PortB (NID = 0Bh): ChSense .....	101
PortB (NID = 0Bh): EAPDBTLLR .....	102
PortB (NID = 0Bh): ConfigDefault .....	102
PortC (NID = 0Ch): WCap .....	105
PortC (NID = 0Ch): PinCap .....	106
PortC (NID = 0Ch): ConLst .....	107
PortC (NID = 0Ch): ConLstEntry0 .....	108
PortC (NID = 0Ch): InAmpLeft .....	108
PortC (NID = 0Ch): InAmpRight .....	109
PortC (NID = 0Ch): ConSelectCtrl .....	109
PortC (NID = 0Ch): PwrState .....	110
PortC (NID = 0Ch): PinWCntrl .....	110
PortC (NID = 0Ch): UnsolResp .....	111
PortC (NID = 0Ch): ChSense .....	112
PortC (NID = 0Ch): EAPDBTLLR .....	112
PortC (NID = 0Ch): ConfigDefault .....	113
PortD (NID = 0Dh): WCap .....	115
PortD (NID = 0Dh): PinCap .....	117
PortD (NID = 0Dh): ConLst .....	118
PortD (NID = 0Dh): ConLstEntry0 .....	119
PortD (NID = 0Dh): ConSelectCtrl .....	119
PortD (NID = 0Dh): PwrState .....	119
PortD (NID = 0Dh): PinWCntrl .....	120
PortD (NID = 0Dh): EAPDBTLLR .....	121
PortD (NID = 0Dh): ConfigDefault .....	121
PortE (NID = 0Eh): WCap .....	124
PortE (NID = 0Eh): PinCap .....	125
PortE (NID = 0Eh): ConLst .....	126
PortE (NID = 0Eh): ConLstEntry0 .....	127
PortE (NID = 0Eh): InAmpLeft .....	127
PortE (NID = 0Eh): InAmpRight .....	128
PortE (NID = 0Eh): ConSelectCtrl .....	128
PortE (NID = 0Eh): PwrState .....	129
PortE (NID = 0Eh): PinWCntrl .....	129
PortE (NID = 0Eh): UnsolResp .....	130
PortE (NID = 0Eh): ChSense .....	130
PortE (NID = 0Eh): EAPDBTLLR .....	131
PortE (NID = 0Eh): ConfigDefault .....	131
PortF (NID = 0Fh): WCap .....	134
PortF (NID = 0Fh): PinCap .....	135
PortF (NID = 0Fh): ConLst .....	136
PortF (NID = 0Fh): ConLstEntry0 .....	137
PortF (NID = 0Fh): InAmpLeft .....	137
PortF (NID = 0Fh): InAmpRight .....	138
PortF (NID = 0Fh): ConSelectCtrl .....	138
PortF (NID = 0Fh): PwrState .....	139
PortF (NID = 0Fh): PinWCntrl .....	139
PortF (NID = 0Fh): UnsolResp .....	140
PortF (NID = 0Fh): ChSense .....	141
PortF (NID = 0Fh): EAPDBTLLR .....	141
PortF (NID = 0Fh): ConfigDefault .....	142
MonoOut (NID = 10h): WCap .....	145
MonoOut (NID = 10h): PinCap .....	146
MonoOut (NID = 10h): ConLst .....	147
MonoOut (NID = 10h): ConLstEntry0 .....	148
MonoOut (NID = 10h): PwrState .....	148

MonoOut (NID = 10h): PinWCntrl .....	149
MonoOut (NID = 10h): ConfigDefault .....	150
DMic0 (NID = 11h): WCap .....	152
DMic0 (NID = 11h): PinCap .....	154
DMic0 (NID = 11h): InAmpLeft .....	155
DMic0 (NID = 11h): InAmpRight .....	155
DMic0 (NID = 11h): PwrState .....	156
DMic0 (NID = 11h): PinWCntrl .....	157
DMic0 (NID = 11h): UnsolResp .....	157
DMic0 (NID = 11h): ChSense .....	158
DMic0 (NID = 11h): ConfigDefault .....	158
DMic1Vol (NID = 12h): WCap .....	161
DMic1Vol (NID = 12h): ConLst .....	162
DMic1Vol (NID = 12h): ConLstEntry0 .....	163
DMic1Vol (NID = 12h): InAmpLeft .....	163
DMic1Vol (NID = 12h): InAmpRight .....	163
DMic1Vol (NID = 12h): PwrState .....	164
DAC0 (NID = 13h): WCap .....	165
DAC0 (NID = 13h): Cnvtr .....	166
DAC0 (NID = 13h): ProcState (RA revision only) .....	167
DAC0 (NID = 13h): OutAmpLeft .....	168
DAC0 (NID = 13h): OutAmpRight .....	168
DAC0 (NID = 13h): PwrState .....	169
DAC0 (NID = 13h): CnvtrID .....	170
DAC0 (NID = 13h): EAPDBTLLR .....	170
DAC0 (NID = 13h): ProclIndex (RA revision only) .....	170
DAC1 (NID = 14h): WCap .....	171
DAC1 (NID = 14h): Cnvtr .....	173
DAC1 (NID = 14h): ProcState (RA revision only) .....	174
DAC1 (NID = 14h): OutAmpLeft .....	174
DAC1 (NID = 14h): OutAmpRight .....	175
DAC1 (NID = 14h): PwrState .....	175
DAC1 (NID = 14h): CnvtrID .....	176
DAC1 (NID = 14h): EAPDBTLLR .....	177
DAC1 (NID = 14h): ProclIndex (RA revision only) .....	177
DAC2 (NID = 22h): WCap .....	178
DAC2 (NID = 22h): Cnvtr .....	179
DAC2 (NID = 22h): OutAmpLeft .....	180
DAC2 (NID = 22h): OutAmpRight .....	181
DAC2 (NID = 22h): PwrState .....	181
DAC2 (NID = 22h): CnvtrID .....	182
DAC2 (NID = 22h): EAPDBTLLR .....	183
ADC0 (NID = 15h): WCap .....	183
ADC0 (NID = 15h): ConLst .....	185
ADC0 (NID = 15h): ConLstEntry0 .....	185
ADC0 (NID = 15h): Cnvtr .....	186
ADC0 (NID = 15h): ProcState .....	187
ADC0 (NID = 15h): PwrState .....	187
ADC0 (NID = 15h): CnvtrID .....	188
ADC1 (NID = 16h): WCap .....	189
ADC1 (NID = 16h): ConLst .....	190
ADC1 (NID = 16h): ConLstEntry0 .....	191
ADC1 (NID = 16h): Cnvtr .....	191
ADC1 (NID = 16h): ProcState .....	193
ADC1 (NID = 16h): PwrState .....	193
ADC1 (NID = 16h): CnvtrID .....	194
ADC0Mux (NID = 17h): WCap .....	194
ADC0Mux (NID = 17h): ConLst .....	196
ADC0Mux (NID = 17h): ConLstEntry4 .....	196

ADC0Mux (NID = 17h): ConLstEntry0 .....	197
ADC0Mux (NID = 17h): OutAmpCap .....	197
ADC0Mux (NID = 17h): OutAmpLeft .....	198
ADC0Mux (NID = 17h): OutAmpRight .....	199
ADC0Mux (NID = 17h): ConSelectCtrl .....	199
ADC0Mux (NID = 17h): PwrState .....	200
ADC0Mux (NID = 17h): EAPDBTLLR .....	200
ADC1Mux (NID = 18h): WCap .....	201
ADC1Mux (NID = 18h): ConLst .....	202
ADC1Mux (NID = 18h): ConLstEntry4 .....	203
ADC1Mux (NID = 18h): ConLstEntry0 .....	203
ADC1Mux (NID = 18h): OutAmpCap .....	204
ADC1Mux (NID = 18h): OutAmpLeft .....	205
ADC1Mux (NID = 18h): OutAmpRight .....	205
ADC1Mux (NID = 18h): ConSelectCtrl .....	206
ADC1Mux (NID = 18h): PwrState .....	206
ADC1Mux (NID = 18h): EAPDBTLLR .....	207
MonoMux (NID = 19h): WCap .....	207
MonoMux (NID = 19h): ConLst .....	209
MonoMux (NID = 19h): ConLstEntry0 .....	209
MonoMux (NID = 19h): ConSelectCtrl .....	210
MonoMux (NID = 19h): PwrState .....	210
MonoMix (NID = 1Ah): WCap .....	211
MonoMix (NID = 1Ah): ConLst .....	213
MonoMix (NID = 1Ah): ConLstEntry0 .....	213
MonoMix (NID = 1Ah): PwrState .....	214
Mixer (NID = 1Bh): WCap .....	215
Mixer (NID = 1Bh): InAmpCap .....	216
Mixer (NID = 1Bh): ConLst .....	217
Mixer (NID = 1Bh): ConLstEntry4 .....	218
Mixer (NID = 1Bh): ConLstEntry0 .....	218
Mixer (NID = 1Bh): InAmpLeft0 .....	219
Mixer (NID = 1Bh): InAmpRight0 .....	219
Mixer (NID = 1Bh): InAmpLeft1 .....	220
Mixer (NID = 1Bh): InAmpRight1 .....	220
Mixer (NID = 1Bh): InAmpLeft2 .....	221
Mixer (NID = 1Bh): InAmpRight2 .....	221
Mixer (NID = 1Bh): InAmpLeft3 .....	222
Mixer (NID = 1Bh): InAmpRight3 .....	222
Mixer (NID = 1Bh): InAmpLeft4 .....	223
Mixer (NID = 1Bh): InAmpRight4 .....	223
Mixer (NID = 1Bh): InAmpLeft5 .....	224
Mixer (NID = 1Bh): InAmpRight5 .....	224
Mixer (NID = 1Bh): PwrState .....	225
MixerOutVol (NID = 1Ch): WCap .....	225
MixerOutVol (NID = 1Ch): ConLst .....	227
MixerOutVol (NID = 1Ch): ConLstEntry0 .....	227
MixerOutVol (NID = 1Ch): OutAmpCap .....	228
MixerOutVol (NID = 1Ch): OutAmpLeft .....	229
MixerOutVol (NID = 1Ch): OutAmpRight .....	229
MixerOutVol (NID = 1Ch): PwrState .....	230
SPDIFOut0 (NID = 1Dh): WCap .....	231
SPDIFOut0 (NID = 1Dh): PCMCap .....	232
SPDIFOut0 (NID = 1Dh): StreamCap .....	234
SPDIFOut0 (NID = 1Dh): OutAmpCap .....	234
SPDIFOut0 (NID = 1Dh): Cnvtr .....	235
SPDIFOut0 (NID = 1Dh): OutAmpLeft .....	236
SPDIFOut0 (NID = 1Dh): OutAmpRight .....	237
SPDIFOut0 (NID = 1Dh): PwrState .....	237

SPDIFOut0 (NID = 1Dh): CnvtrID .....	238
SPDIFOut0 (NID = 1Dh): DigCnvtr .....	239
SPDIFOut1 (NID = 1Eh): WCap .....	240
SPDIFOut1 (NID = 1Eh): PCMCap .....	241
SPDIFOut1 (NID = 1Eh): StreamCap .....	243
SPDIFOut1 (NID = 1Eh): OutAmpCap .....	243
SPDIFOut1 (NID = 1Eh): Cnvtr .....	244
SPDIFOut1 (NID = 1Eh): OutAmpLeft .....	245
SPDIFOut1 (NID = 1Eh): OutAmpRight .....	246
SPDIFOut1 (NID = 1Eh): PwrState .....	246
SPDIFOut1 (NID = 1Eh): CnvtrID .....	247
SPDIFOut1 (NID = 1Eh): DigCnvtr .....	248
Dig0Pin (NID = 1Fh): WCap .....	249
Dig0Pin (NID = 1Fh): PinCap .....	250
Dig0Pin (NID = 1Fh): ConLst .....	251
Dig0Pin (NID = 1Fh): ConLstEntry0 .....	252
Dig0Pin (NID = 1Fh): PwrState .....	252
Dig0Pin (NID = 1Fh): PinWCntrl .....	253
Dig0Pin (NID = 1Fh): UnsolResp .....	254
Dig0Pin (NID = 1Fh): ChSense .....	254
Dig0Pin (NID = 1Fh): ConfigDefault .....	255
Dig1Pin (NID = 20h): WCap .....	257
Dig1Pin (NID = 20h): PinCap .....	259
Dig1Pin (NID = 20h): ConLst .....	260
Dig1Pin (NID = 20h): ConLstEntry0 .....	261
Dig1Pin (NID = 20h): PwrState .....	261
Dig1Pin (NID = 20h): PinWCntrl .....	262
Dig1Pin (NID = 20h): UnsolResp .....	263
Dig1Pin (NID = 20h): ChSense .....	263
Dig1Pin (NID = 20h): ConfigDefault .....	264
DigBeep (NID = 21h): WCap .....	266
DigBeep (NID = 21h): OutAmpCap .....	267
DigBeep (NID = 21h): OutAmpLeft .....	268
DigBeep (NID = 21h): PwrState .....	268
DigBeep (NID = 21h): Gen .....	269
<b>PINOUTS .....</b>	<b>271</b>
Pin Assignment .....	271
Pin Table for 48-pin QFN .....	272
<b>PACKAGE OUTLINE AND PACKAGE DIMENSIONS .....</b>	<b>274</b>
48-Pad QFN Package .....	274
Standard Reflow Profile Data .....	275
<b>DISCLAIMER.....</b>	<b>276</b>
<b>DOCUMENT REVISION HISTORY .....</b>	<b>277</b>



**LIST OF FIGURES**

Multi-channel capture .....21  
Multi-channel timing diagram ..... 21  
Single Digital Microphone (data is ported to both left and right channels) .....24  
Stereo Digital Microphone Configuration .....25  
Quad Digital Microphone Configuration ..... 26  
HP EAPD Example to be replaced by single pin for internal amp ..... 30  
HD Audio Bus Timing .....43  
Functional Block Diagram .....46  
Widget Diagram .....47  
Desktop Port Configurations .....48  
Port Configuration .....49  
Pin Assignment ..... 271  
48QFN Package Diagram .....274  
Solder Reflow Profile ..... 275

**LIST OF TABLES**

Port Functionality ..... 12

Analog Output Port Behavior ..... 13

SPDIF OUT 0 Behavior ..... 14

SPDIF OUT 1 Behavior ..... 15

Power Management ..... 18

Example channel mapping..... 21

BTL Amp Status ..... 29

Headphone Amp Enable Configuration ..... 29

EAPD Low Power Behavior ..... 29

EAPD Behavior ..... 30

Electrical Specification: Maximum Ratings ..... 38

Recommended Operating Conditions ..... 38

92HD81 Analog Performance Characteristics ..... 39

HD Audio Bus Timing ..... 43

SPDIF Timing ..... 44

Digital Mic timing ..... 44

Class-AB BTL Amplifier Performance ..... 44

Capless Headphone Supply ..... 45

Pin Configuration Default Settings ..... 50

Command Format for Verb with 4-bit Identifier ..... 51

Command Format for Verb with 12-bit Identifier ..... 51

Solicited Response Format ..... 51

Unsolicited Response Format ..... 51

High Definition Audio Widget ..... 51

Pin Table ..... 272

Standard Reflow Profile ..... 275

# 92HD81

## SINGLE CHIP PC AUDIO SYSTEM, CODEC+SPEAKER AMPLIFIER+CAPLESS HP+LDO

### 1. DESCRIPTION

#### 1.1. Overview

The 92HD81 is a high fidelity, 4-channel audio codec compatible with the Intel High Definition (HD) Audio Interface. The 92HD81 codec provides high quality, HD Audio capability notebooks and business desktops.

The 92HD81 is designed to meet or exceed premium logo requirements for Microsoft's Windows Logo Program (WLP) 3.09 and revisions 4/5 as indicated in WLP 3.09.

The 92HD81 provides stereo 24-bit, full duplex resolution supporting sample rates up to 192kHz by the DAC and ADC. 92HD81 SPDIF outputs support sample rates of 192kHz, 176.4kHz, 96kHz, 88.2kHz, 48kHz, and 44.1kHz. 92HD81 SPDIF input supports sample rates of 96kHz, 88.2kHz, 48kHz, and 44.1kHz. Additional sample rates are supported by the driver software.

The 92HD81 supports a wide range of notebook and business desktop 4-channel configurations. The 2 independent SPDIF output interfaces provides connectivity to Consumer Electronic equipment like Dolby Digital decoders, powered speakers, mini disk drives or to a home entertainment system. Simultaneous HDMI and SPDIF output is possible.

An integrated BTL stereo amplifier is ideal for driving integrated speakers in mobile and ultra-mobile computers. For desktop computers or mobile computers using only one speaker, the BTL output stage may be configured to support a single mono speaker.

MIC inputs can be programmed with 0/10/20/30dB boost. For more advanced configurations, the 92HD81 has 3 General Purpose I/O (GPIO).

The port presence detect capabilities allow the codecs to detect when audio devices are connected to the codec. Load impedance sensing helps identify attached peripherals for easy set-up and a better user experience. The fully parametric TSI SoftEQ can be initiated upon headphone jack insertion and removal for protection of notebook speakers.

The 92HD81 operates with a 1.5V, 1.8V or 3.3V digital supply and a 5V analog supply. It can also work with 1.5V and 3.3V HDA signaling; the correct signalling level is selected dynamically based on the power supply voltage on the DVDD-IO pin.

The 92HD81 is available in a 48-pin QFN Environmental (ROHS) package.

#### 1.2. Orderable Part Numbers

92HD81B1X5NLGXyyX	5V Analog, Aux Audio mode enabled
92HD81B1C5NLGXyyX	5V Analog
92HD81B1A5NLGXyyX	OEM custom part number
92HD81B1B5NLGXyyX	OEM custom part number

yy = silicon stepping/revision, contact sales for current data.

Add an "8" to the end for tape and reel delivery. Min/Mult order quantity 2ku.

## 2. DETAILED DESCRIPTION

### 2.1. Port Functionality

Multi-function (Input / output) ports allow for the highest possible flexibility. 3 or 4 bi-directional ports, 2 headphone ports, and a high power BTL amplifier support a wide variety of consumer desktop and mobile system use models.

The port capabilities are as follows

- Port A supports
  - Headphone
  - Line Out
  - Line Input
  - Mic with 0/10/20/30 dB Boost and Vref\_Out
- Port B supports
  - Capless Headphone Out
  - Capless Line Out
- Port C supports
  - Line Out (not supported on TA revision, supported on RA revision)
  - Line In
  - Mic with 0/10/20/30 dB boost and Vref\_Out
- Port D supports
  - BTL stereo output
  - BTL (L+/L-) mono out
- Port E supports
  - Line Out
  - Line In
  - Mic with 0/10/20/30 dB boost
- Port F supports
  - Line Out
  - Line In
  - Mic with 0/10/20/30 dB boost
- Mono Out supports
  - Line Out

Pins	Port	Input	Output	Headphone	BTL	Mic Bias (Vref pin)	Input boost amp
28/29	A	Yes	Yes	Yes		Yes	Yes
31/32	B		Yes	Yes			
19/20	C	Yes	Yes (not on TA revision)			Yes	Yes
40/41/43/44	D		Yes		Yes		
15/16	E	Yes	Yes				Yes
17/18	F	Yes	Yes				Yes
27	Mono Out		Yes				
48	SPDIF_OUT0		Yes				
46	SPDIF_OUT1 DMIC1 (CLK=2)	Yes	Yes				Yes
4 (CLK=2)	DMIC0	Yes					Yes

Table 1. Port Functionality

### 2.1.1. Port Characteristics

Universal (Bi-directional) jacks are supported on ports C (TA revision only, Port C is input only), E, and F. Port A is bidirectional also. Ports A and B are designed to drive 32 ohm (nominal) headphones or a 10K (nominal) load. Line Level outputs are intended to drive an external 10K load (nominal) and an on board shunt resistor of 20-47K (nominal). However, applications may support load impedances of 5K ohms and above. Input ports are 50K (nominal) at the pin.

DAC full scale outputs and intended full scale input levels are 1V rms at 5V. Line output ports and Headphone output ports on the 92HD80 codec may be configured for +3dBV full scale output levels by using a vendor specific verb.

Output ports are always on to prevent pops/clicks associated with charging and discharging output coupling capacitors. This maintains proper bias on output coupling caps even in power state D3 as long as AVDD is available. Unused ports should be left unconnected. When updating existing designs to use the 92HD80 codec, ensure that there are no conflicts between the output ports on the 92HD80 codec and existing circuitry.

AFG Power State	Input Enable	Output Enable	Port Behavior
D0-D2	1	1	Not allowed. Port is active as output. Input path is mute.
	1	0	Active - Port enabled as input
	0	1	Active - Port enabled as output
	0	0	Inactive -port is powered on (low output impedance) but drives silence only.
D3	-	0	Inactive (lower power) - Port keeps output coupling caps charged if port uses caps.
	-	1	Low power state. If enabled, Beep will output from the port
D3cold	-	-	Inactive (lower power) - Port keeps output coupling caps charged if port uses caps.
D4	-	-	Inactive (lower power) - Port keeps output coupling caps charged if port uses caps.
D5	-	-	Off - Charge on coupling caps (if used) will not be maintained.

Table 2. Analog Output Port Behavior

### 2.1.2. Vref\_Out

Ports C & A support Vref\_Out pins for biasing electret cartridge microphones. Settings of 80% AVDD, 50% AVDD, GND, and Hi-Z are supported. Attempting to program a pin widget control with a reserved or unsupported value will cause the associated Vref\_Out pin to assume a Hi-Z state and the pin widget control Vref\_En field will return a value of '000' (Hi-Z) when read.

### 2.1.3. Jack Detect

Plugs inserted to a jack on Ports A, B, C & SPDIFOUT0 are detected using SENSE\_A. Plugs inserted to a jack on Ports E,F, DMIC0, & SPDIFOUT1 are detected using SENSE\_B. Per HDA015-B, the detection circuit operates when the CODEC is in D0 - D3 and can also operate if both the CODEC and Controller are in D3 (no bus clock.) Jack detection requires that all supplies (analog and digital) are active and stable. When AVDD is not present, the value reported in the pin widget is invalid.

When the HD Audio bus is in a low power state (reset asserted and clock stopped) the CODEC will generate a Power State Change Request when a change in port connectivity is sensed and then generate an unsolicited response after the HD Audio link has been brought out of a low power state and the device has been enumerated. Per HDA015-B, this will take less than 10mS.

The following table summarizes the proper resistor tolerances for different analog supply voltages.

AVdd Nominal Voltage (+/- 5%)	Resistor Tolerance Pull-Up	Resistor Tolerance SENSE_A/B
4.75V	1%	1%

Resistor	SENSE_A	SENSE_B
39.2K	PORT A (HP0)	PORT E
20.0K	PORT B (HP1)	PORT F
10.0K	PORT C	DMIC0
5.11K	SPDIFOUT0	SPDIFOUT1 (DMIC1)
2.49K	Pull-up to AVDD	Pull-up to AVDD

See reference design for more information on Jack Detect implementation.

#### 2.1.4. SPDIF Output

Both SPDIF Outputs can operate at 44.1kHz, 48kHz, 88.2kHz, 96kHz and 192kHz as defined in the Intel High Definition Audio Specification with resolutions up to 24 bits. This insures compatibility with all consumer audio gear and allows for convenient integration into home theater systems and media center PCs.

Per the HDA015-B ECR, the SPDIF outputs support the ability to provide clocking information even when no stream is selected for the converter, or when in a low power state. Also, as stated in the ECR, the SPDIF output ports support port presence detect.

SPDIF Outputs are outlined in tables below.

AFG Power State	RESET#	Output Enable	Converter Dig Enable	Stream ID	Keep Alive Enable	Pin Behavior
D0-D3	Asserted (Low)	-	-	-	-	Hi-Z (internal pull-down enabled) immediately after power on, otherwise the previous state is retained.

Table 3. SPDIF OUT 0 Behavior

AFG Power State	RESET#	Output Enable	Converter Dig Enable	Stream ID	Keep Alive Enable	Pin Behavior
D0	De-Asserted (High)	Disabled	-	-	-	Hi-Z (internal pull-up enabled)
	De-Asserted (High)	Enabled	Disabled	-	-	Active - Pin drives 0 (internal pull-down NA)
	De-Asserted (High)	Enabled	Enabled	0	-	Active - Pin drives SPDIF-format, but data is zeroes (internal pull-down NA)
	De-Asserted (High)	Enabled	Enabled	1-15	-	Active - Pin drives SPDIFOut0 data (internal pull-down NA)
D1-D2	De-Asserted (High)	Disabled	-	-	-	Hi-Z (internal pull-down enabled)
	De-Asserted (High)	Enabled	-	-	0	Active - Pin drives 0 (internal pull-down NA)
D3	De-Asserted (High)	Enabled	Enabled	-	1	Active - Pin drives SPDIF-format, but data is zeroes (internal pull-down NA)
		Disabled	-	-	1	Hi-Z (internal pull-down enabled)
		Enabled	Enabled	-	1	Active - Pin drives SPDIF-format, but data is zeroes (internal pull-down NA)
D3cold	-	-	-	-	-	Hi-Z (internal pull-down enabled)
D4	-	-	-	-	-	Hi-Z (port off)
D5	-	-	-	-	-	Hi-Z (port off)

Table 3. SPDIF OUT 0 Behavior

AFG Power State	RESET#	GPIO0 Enable	Input Enable	Output Enable	Converter Dig En	Stream ID	Keep Alive En	Pin Behavior
D0-D3	Asserted (Low)	-	-	-	-	-	-	Hi-Z (internal pull-down enabled) immediately after power on, otherwise the previous state is retained.
D0-D3	De-Asserted (High)	Enabled	-	-	-	-	-	Active - Pin reflects GPIO0 configuration (internal pull-up enabled)
D0-D3	De-Asserted (High)	Disabled	Enabled	Disabled	-	-	-	Pin functions as digital mic input (internal pull-down enabled)

Table 4. SPDIF OUT 1 Behavior

AFG Power State	RESET#	GPIO0 Enable	Input Enable	Output Enable	Converter Dig En	Stream ID	Keep Alive En	Pin Behavior
D0	De-Asserted (High)	Disabled	Disabled	Disabled	-	-	-	Hi-Z (internal pull-down enabled)
					Disabled	-	-	Active - Pin drives 0 (internal pull-down NA)
			-	Enabled	Enabled	0	-	Active - Pin drives SPDIF-format, but data is zeroes (internal pull-down NA)
					Enabled	1-15	-	Active - Pin drives SPDIFOut1 data (internal pull-down NA)
D1-D2	De-Asserted (High)	Disabled	Disabled	Disabled	-	-	-	Hi-Z (internal pull-down enabled)
					Disabled	-	-	Active - Pin drives 0 (internal pull-down NA)
				Enabled	-	0	Active - Pin drives 0 (internal pull-down NA)	
					Enabled	-	1	Active - Pin drives SPDIF-format, but data is zeroes (internal pull-down NA)
D3	De-Asserted (High)	Disabled	Disabled	Disabled	-	-	-	Hi-Z (internal pull-down enabled)
					Disabled	-	-	Hi-Z (internal pull-down enabled)
				Enabled	-	0	Hi-Z (internal pull-down enabled)	
					Enabled	-	1	Active - Pin drives SPDIF-format, but data is zeroes (internal pull-down NA)
D3cold	-	Disabled	Disabled	-	-	-	Hi-Z (internal pull-down enabled)	
D4	-	-	-	-	-	-	-	Hi-Z (port off)
D5	-	-	-	-	-	-	-	Hi-Z (port off)

Table 4. SPDIF OUT 1 Behavior



## **2.2. Mono Output**

The MONO Output has an independent mute (see the Widget listing for details). The MONO Output derives its input from the output of the summing node after the mono mux. The following sources are available for the mono pin:

- DAC0 Output: When selected (by using port connection list), both DAC0 outputs are summed together.
- DAC1 Output: When selected (by using port connection list), both DAC1 outputs are summed together.
- Mixer Output: When selected (by using port connection list), both mixer outputs are summed together.

The stereo inputs are scaled by -6dB and then summed to provide an output that is the average of the two inputs. The full scale output at mono out is designed to be about 0dBV. It is not possible to adjust to a +3dBV output level.

## **2.3. Analog Mixer**

The mixer supports independent gain (-34.5 to +12dB in 1.5dB steps) on each input as well as independent mutes on each input. The following inputs are available:

- Port A
- Port C
- Port E
- Port F

## **2.4. ADC Multiplexers**

The 92HD80 codec implements 2 ADC input multiplexers. These multiplexers incorporate the ADC record gain function (0 to +22.5dB gain in 1.5dB steps) as an output amp and allow a preselection of one of 7 possible inputs:

- Port A
- Port C
- Port E
- Port F
- Mixer Output
- DMIC 0
- DMIC 1

## **2.5. Power Management**

The HD Audio specification defines power states, power state widgets, and power state verbs. Power management is implemented at several levels. The Audio Function Group (AFG), all converter widgets, and all pin complexes support the power state verb F05/705. Converter widgets are active in D0 and inactive in D1-D3.

The following table describes what functionality is active in each power state.

Function	D0	D1 <sup>1</sup>	D2	D3	D3cold	Vendor Specific D4	Vendor Specific D5
SPDIF Outputs	On	On	On(idle)	On(idle) <sup>5</sup>	Off	Off	Off
Digital Microphone inputs	On	Off	Off	Off	Off	Off	Off
DAC	On	Off	Off	Off	Off	Off	Off
D2S	On	Off	Off	Off	Off	Off	Off
ADC	On	Off	Off	Off	Off	Off	Off
ADC Volume Control	On	Off	Off	Off	Off	Off	Off
Ref ADC	On	Off	Off	Off	Off	Off	Off
Analog Clocks	On	Off	Off	Off	Off	Off	Off
GPIO pins	On	On	On	On <sup>5</sup>	On	On	Off
VrefOut Pins	On	On	Off	Off	Off	Off	Off
Input Boost	On	On	Off	Off	Off	Off	Off
Analog mixer	On	On	Off	Off	Off	Off	Off
Mixer Volumes	On	On	Off	Off	Off	Off	Off
Analog PC_Beep	On	On	On	On	Off	Off	Off
Digital PC_Beep	On	On	On	On <sup>5</sup>	Off	Off	Off
Lo/HP Amps	On	On	On	Low Drive <sup>2</sup>	Low Drive <sup>2</sup>	Low Drive <sup>2</sup>	Off
Capless HP Amps	On	On	On	Low Drive <sup>2</sup>	Low Drive <sup>2</sup>	Low Drive <sup>2</sup>	Off
BTL Amp	On	On	On	Low Drive <sup>2</sup>	Off	Off	Off
VAG amp	On	On	On	Low Drive <sup>3</sup>	Low Drive	Low Drive	Off
Port Sense	On	On	On	On <sup>4</sup>	Off	Off	Off
Reference Bias generator	On	On	On	On	On	On	Off
Reference Bandgap core	On	On	On	On	On	On	Off
HD Audio-Link	On	On	On	On <sup>5</sup>	Limited	Off	Off

Table 5. Power Management

1. No DAC or ADC streams are active. Analog mixing and loop thru are supported.
2. VAG is kept active when ports are disabled or in D3/D3cold/D4. PC\_Beep is supported in D3 but may be attenuated and distorted depending on load impedance.
3. VAG is always ramped up and down gradually, except in the case of a sudden power removal. VAG is active in D2/D3 but in a low power state.
4. Both AVDD and DVDD must be available for Port Sense to operate.
5. Not active if BITCLK is not running (Controller in D3), but can signal power state change request (PME)

The D3-default state is available for HD Audio compliance. The programmable values, exposed via vendor-specific settings, are under TSI Device Driver control for further power reduction. The analog mixer, line and headphone amps, port presence detect, and internal references may be disabled using vendor specific verbs. Use of these vendor specific verbs will cause pops.

The default power state for the Audio Function Group after reset is D3.

## 2.6. AFG D0

The AFG D0 state is the active state for the device. All functions are active if their power state (if they support power management at their node level) has been set to D0.

## 2.7. AFG D1

D1 is a lower power mode where all converter widgets are disabled. Analog mixer and port functions are active. The part will resume from the D1 to the D0 state within 1 mS.

## 2.8. AFG D2

The D2 state further reduces power by disabling the mixer and port functions. The port amplifiers and internal references remain active to keep port coupling caps charged and the system ready for a quick resume to either the D1 or D0 state. The part will resume from the D2 state to the D0 state within 2mS.

## 2.9. AFG D3

The D3-default state is available for HD Audio compliance. All converters are shut down. Port amplifiers and references are active but in a low power state to prevent pops. Resume times may be longer than those from D2, but still less than 10mS to meet Intel low power goals. The default power state for the Audio Function Group after power is applied is D3.

The traditional use for D3 was as a transitional state before power was removed (D3 cold) before the system entered into standby, hibernate, or shut-down. To conserve power, Intel now promotes using D3 whenever there are no active streams or other activity that requires the part to consume full power. The system remains in S0 during this time. When a stream request or user activity requires the CODEC to become active, the driver will immediately transition the CODEC from D3 to D0. To enable this use model, the CODEC must resume within 10mS and not pop. Intel HDA ECR-15b / Low Power White paper power goals are < 30mW when analog PC\_Beep is not enabled, and < 60mW when analog PC\_Beep is enabled. (Charge pump and BTL amplifier power excluded.)

While in AFG D3, the HD Audio controller may be in a D0 state (HD Audio bus active) or in a D3 state (HD Audio bus held in reset with no Bit\_Clk, SData\_Out, or Sync activity.) The expected behavior is as follows (see the ECR15b section for more information):

Function	HDA Bus active	HDA Bus stopped
Port Presence Detect state change	Unsolicited Response	Wake Event <sup>1</sup> followed by an unsolicited response
GPIO state change	Unsolicited Response	Wake Event followed by an unsolicited response

1.The Port Presence detect circuit is currently dependent on a clock and must be changed to generate a wake event.

### 2.9.1. AFG D3cold

The D3cold power state is the lowest power state available that does not use vendor specific verbs. While in D3cold, the CODEC will still respond to bus requests to revert to a higher power state (double AFG reset, link reset). However, audio processing, port presence detect, and other functions are disabled. Per the HD Audio bus ECR 015b, the D3cold state is intended to be used just prior to removing power to the CODEC. Typically, power will be removed within 200mS. However, the codec may exit from the D3cold state by generating 2, back-to-back, AFG reset events. Resume time from D3cold is less than 200mS.

## 2.10. Vendor Specific Function Group Power States D4/D5

The 92HD80 introduces vendor specific power states. A vendor defined verb is added to the Audio Function Group that combines multiple vendor specific power control bits into logical power states for use by the audio driver. The 2 states defined offer lower power than the 5 existing states defined in the HD Audio specification and ECR15b. The Vendor Specific D4 state provides lower digital power consumption relative to D3cold by disabling HD Audio link responses. Vendor specific D5 further reduces power consumption on the digital supply by turning off GPIO drivers, and reduces analog power consumption by turning off all analog circuitry except for reset circuits.

States D4/D5 are not entered until D3cold has been requested. Software can pre-program the D4 or D5 state as a re-definition of how the part will behave when the D3cold power state is requested or software may enter D3cold, then set the D4 or D5. The preferred method is to request D3cold, then select D4 or D5 as desired. This will reduce the severity of pops encountered when entering D4 or D5.

Both power states require a link reset or removal of DVDD to exit.

The CODEC may pop when using these verbs and transition times to an active state (D1 or D0 for example) may take several seconds.

## 2.11. Low-voltage HDA Signaling

The 92HD80 codec is compatible with either 1.5V or 3.3V HDA bus signaling; the voltage selection is done dynamically based on the input voltage of DVDD\_IO.

DVDD\_IO is currently not a logic configuration pin, but rather provides the digital power supply to be used for the HDA bus signals.

When in 1.5V mode, the 92HD80 codec can correctly decode BITCLK, SYNC, RESET# and SDO as they operate at 1.5V; additionally it will drive SDI and SDO at 1.5V. None of the GPIOs are affected, as they always function at their nominal voltage (DVDD or AVDD).

## 2.12. Multi-channel capture

The capability to assign multiple “ADC Converters” to the same stream is supported to meet the microphone array requirements of Vista and future operating systems. Single converter streams are still supported this is done by assigning unique non zero Stream IDs to each converter. All capture devices (ADCs 0 and 1) may be used to create a multi-channel input stream. There are no restrictions regarding digital microphones.

The ADC Converters can be associated with a single stream as long the sample rate and the bits per sample are the same. The assignment of converter to channel is done using the “CnvtrID” widget and is restricted to even values. The ADC converters will always put out a stereo sample and therefore require 2 channels per converter.

The stream will not be generated unless all entries for the targeted converters are set identically, and the total number of assigned converter channels matches the value in the NmbrChan field. These are listed the “Multi-Converter Stream Critical Entries.” table.

An example of a 4 Channel Stream with ADC0 supplying channels 0&1 and ADC1 supplying channels 2 & 3 is shown below. A 4 Channel stream can be created by assigning the same non-zero stream id “Strm= N” to both ADC0 and ADC1. The sample rates must be set the same and the number of channels must be set to 4 channels “NmbrChan = 0011”.

ADC1 CnvtrID	(NID = 0x08)	
	[3:0]	Ch = 2
ADC0 CnvtrID	(NID = 0x07)	
	[3:0]	Ch=0

Table 6. Example channel mapping

Figure 1. Multi-channel capture

ADC0.CnvtrID.Channel = 0	Stream ID	Data Length	ADC0 Left Channel	ADC0 Right Channel	ADC1 Left Channel	ADC1 Right Channel
ADC1.CnvtrID.Channel = 2	Stream ID	Data Length	ADC1 Left Channel	ADC1 Right Channel	ADC0 Left Channel	ADC0 Right Channel

The following figure describes the bus waveform for a 24-bit, 48KHz capture stream with ID set to 1.

Figure 2. Multi-channel timing diagram



ADC[1:0] Cnvtr	Bit Number	Sub Field Name	Description
	[15]	StrmType	Stream Type (TYPE): 0: PCM 1: Non-PCM (not supported)
	[14]	FrmtSmplRate	Sample Base Rate 0= 48kHz 1=44.1KHz
	[13:11]	SmplRateMultp	Sample Base Rate Multiple 000=48kHz/44.1kHz or less 001= x2 010= x3 (not supported) 011= x4 100-111= Reserved

Table 7: Mult-channel

	[10:8]	SmplRateDiv	Sample Base Rate Divisor 000= Divide by 1 001= Divide by 2 (not supported) 010= Divide by 3 (not supported) 011= Divide by 4 (not supported) 100= Divide by 5 (not supported) 101= Divide by 6 (not supported) 110= Divide by 7 (not supported) 111= Divide by 8 (not supported)
	[6:4]	BitsPerSmpl	Bits per Sample 000= 8 bits (not supported) 001= 16 bits 010= 20 bits 011= 24 bits 100-111= Reserved
	[3:0]	NmbrChan	Number of Channels Number of channels for this stream in each “sample block” of the “packets” in each “frame” on the link. 0000=1 channel (not supported) 0001 = 2 channels ... 1111= 16 channels.
	[7:4]	Strm	Software-programmable integer representing link stream ID used by the converter widget. By convention stream 0 is reserved as unused.
	[3:0]	Ch	Integer representing lowest channel used by converter. 0 and 2 are valid Entries If assigned to the same stream, one ADC must be assigned a value of 0 and the other ADC assigned a value of 2.

Table 7: Mult-channel

## 2.13. Digital Microphone Support

The digital microphone interface permits connection of a digital microphone(s) to the CODEC via the DMIC0, DMIC1, and DMIC\_CLK 3-pin interface. The DMIC0 and DMIC1 signals are inputs that carry individual channels of digital microphone data to the ADC. In the event that a single microphone is used, the data is ported to both ADC channels. This mode is selected using a vendor specific verb and the left time slot is copied to the ADC left and right inputs.

The DMIC\_CLK output is controllable from 4.704Mhz, 3.528Mhz, 2.352Mhz, 1.176Mhz and is synchronous to the internal master clock. The default frequency is 2.352Mhz.

The two DMIC data inputs are reported as two stereo input pin widgets that incorporate a boost amplifier. The pin widgets are shown connected to the ADCs through the same multiplexors as the analog ports. Although the internal implementation is different between the analog ports and the digital microphones, the functionality is the same. In most cases, the default values for the DMIC clock rate and data sample phase will be appropriate and an audio driver will be able to configure and use the digital microphones exactly like an analog microphone.

To conserve power, the analog portion of the ADC will be turned off if the D-mic input is selected. When switching from the digital microphone to an analog input to the ADC, the analog portion of the

## 92HD81

### SINGLE CHIP PC AUDIO SYSTEM, CODEC+SPEAKER AMPLIFIER+CAPLESS HP+LDO

ADC will be brought back to a full power state and allowed to stabilize before switching from the digital microphone to the analog input. This should take less than 10mS.

DMIC pin widgets support port presence detect directly using SENSE-B input.

The codec supports the following digital microphone configurations:

Digital Mics	Data Sample	ADC Conn.	Notes
0	N/A	N/A	No Digital Microphones
1	Single Edge	0, or 1	Available on either DMIC_0 or DMIC_1 When using a microphone that supports multiplexed operation (2-mics can share a common data line), configure the microphone for “Left” and select mono operation using the vendor specific verb. “Left” D-mic data is used for ADC left and right channels.
2	Double Edge on either DMIC_0 or 1	0, or 1	Available on either DMIC_0 or DMIC_1, External logic required to support sampling on a single Digital Mic pin channel on rising edge and second Digital Mic right channel on falling edge of DMIC_CLK for those digital microphones that don't support alternative clock edge (multiplexed output) capability.
3	Double Edge on one DMIC pin and Single Edge on the second DMIC pin.	0, or 1	Requires both DMIC_0 and DMIC_1, External logic required to support sampling on a single Digital Mic pin channel on rising edge and second Digital Mic right channel on falling edge of DMIC_CLK for those digital microphones that don't support alternative clock edge (multiplexed output) capability. Two ADC units are required to support this configuration
4	Double Edge	0, or 1	Connected to DMIC_0 and DMIC_1, External logic required to support sampling on a single Digital Mic pin channel on rising edge and second Digital Mic right channel on falling edge of DMIC_CLK for those digital microphones that don't support alternative clock edge capability. Two ADC units are required to support this configuration

Power State	DMIC Widget Enabled?	DMIC_CLK Output	DMIC_0,1	Notes
D0	Yes	Clock Capable	Input Capable	DMIC_CLK Output is Enabled when either DMIC_0 or DMIC_1 Input Widget is Enabled. Otherwise, the DMIC_CLK remains Low
D1-D3	Yes	Clock Disabled	Input Disabled	DMIC_CLK is HIGH-Z with Weak Pull-down
D0-D3	No	Clock Disabled	Input Disabled	DMIC_CLK is HIGH-Z with Weak Pull-down
D4	-	Clock Disabled	Input Disabled	DMIC_CLK is HIGH-Z with Weak Pull-down
D5	-	Clock Disabled	Input Disabled	DMIC_CLK is HIGH-Z with Weak Pull-down

Figure 3. Single Digital Microphone (data is ported to both left and right channels)



**Single Microphone not supporting multiplexed output.**

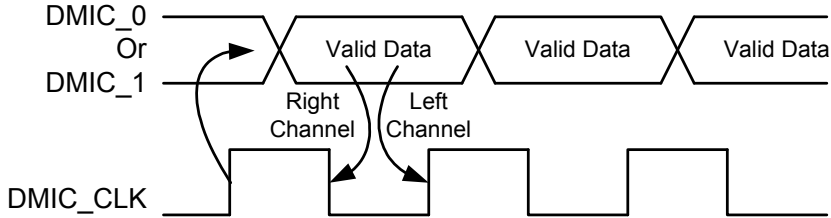

**Single "Left" Microphone, DMIC input set to mono input mode.**

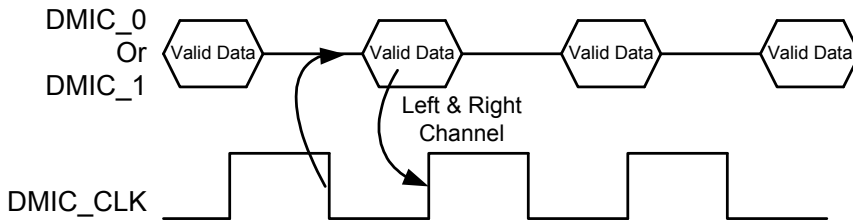



Figure 4. Stereo Digital Microphone Configuration



Note: Some Digital Microphone Implementations support data on either edge, therefore, the external mux may not be required.

Figure 5. Quad Digital Microphone Configuration



Note: Some Digital Microphone Implementations support data on either edge, in this case the external multiplexer isn't required.

## 2.14. Analog PC-Beep

The codec does not support automatic routing of the PC\_Beep pin to all outputs when the HD-Link is in reset. Analog PC-Beep may be supported during HD-Link Reset if analog PC\_Beep is manually enabled before entering reset and the level shifters are locked. Analog PC\_Beep is mixed at the port and only ports enabled as outputs will pass PC\_Beep. Analog PC\_Beep (or a digital equivalent) must not prevent passing WLP when analog PC\_Beep is enabled. Analog PC\_Beep, when enabled, must not prevent other audio sources from playing (we must mix not mux.) An activity monitor will allow the BTL amplifier (and cap-less headphone amplifiers if possible) to remain in shutdown when the function group is in D3 until the beep pin is active and then quickly change to an active state (within 10mS) to pass the beep tone. Beeps from ICH (from Beep.sys) can have a frequency of about 37Hz to about 32KHz. Beep duration is programmable from 1mS to about 32 seconds. A typical beep under Windows XP is 500Hz or 2KHz and lasts 75ms or 150mS. Due to external XOR gates used as mixers, the idle state may be logic 0 or logic 1.

PC-Beep may be attenuated and distorted when the CODEC is in D3 depending on the load impedance seen by the output amplifier since all ports are in a low power state while in D3. Load impedances of 10K or larger can support full scale outputs but lower impedance loads will distort unless the output amplitude is reduced.

Analog PC\_Beep is not supported in D3 Cold, or the vendor specific states D4/D5.

## 2.15. Digital PC-Beep

This block uses an 8-bit divider value to generate the PC beep from the 48kHz HD Audio Sync pulse. The digital PC\_Beep block generates the beep tone on all Pin Complexes that are currently configured as outputs. The HD Audio spec states that the beep tone frequency = (48kHz HD Audio SYNC rate) / (4\*Divider), producing tones from 47 Hz to 12 kHz (logarithmic scale). Other audio sources are disabled when digital PC\_Beep is active.

It should be noted that digital PC Beep is disabled if the divider = 00h.

PC-Beep may be attenuated and distorted when the CODEC is in D3 depending on the load impedance seen by the output amplifier since all ports are in a low power state while in D3. Load impedances of 10K or larger can support full scale outputs but lower impedance loads will distort unless the output amplitude is reduced. Digital PC\_Beep requires a clock to operate and the CODEC will prevent the system from stopping the bus clock while in D3 by setting the Clock\_Stop\_OK bit to 0 to indicate that the part requires a clock.

## 2.16. Headphone Drivers

The codec implements capless headphone outputs. The Microsoft Windows Logo Program allows up to the equivalent of 100ohms in series. However, an output level of +3dBV at the pin is required to support 300mV at the jack with a 32ohm load and 1V with a 320 ohm load. Microsoft allows device and system manufactures to limit output voltages to address EU safety requirements. (WLP 3.09 - please refer to the latest Windows Logo Program requirements from Microsoft.)

The capless headphone drivers are supplied with +/-2.5V derived from AVDD. Therefore, it is possible to run the headphone supply from 5V and maintain ~60mW peak output power into 32 ohm headphones. Headphone performance will degrade if more than one port is driving a 32 ohm load.

## 2.17. EAPD

The EAPD pin (pin 47) is a dedicated, bi-directional control pin. Although named External Amplifier Power Down (EAPD) by the HD Audio specification, this pin operates as an external amplifier power up signal. The EAPD value is reflected on the EAPD pin; a 1 causes the external amplifier to power up (equivalent to D0), and a 0 causes it to power down (equivalent to D3.) When the EAPD value = 1, the EAPD pin must be placed in a state appropriate to the current power state of the associated Pin Widget even though the EAPD value (in the register) may remain 1. The default state of this pin is 0 (driving low.) The pin defaults to an open-drain configuration (an external pull-up is recommended.)

Per the HD Audio specification and ECR15b, multiple ports may control EAPD. The EAPD pin assumes the highest power state of all the EAPD bits in all of the pin complexes. The default value of EAPD is 1 (powered on), but the FG power state will override and the pin will be low. A port will request External Amp Power Up when its power state is active (FG and pin widget power state is D1 or D0) or (Analog PC\_Beep is enabled and port is enabled as an output) and the port's EAPD bit is set to 1. The state of the EAPD pin (unless configured as an input or held low by an external circuit when configured as an open drain output) will be the logical OR of the external amp power up requests from all ports.

By default, the EAPD pin also functions as the Mute#/ShutDown# input for the internal BTL amplifier. In this mode, a low value at the pin (either due to internal EAPD being 0, or to an external entity forcing the pin low) will cause the internal BTL amplifier to mute or enter a low power state depending on the amplifier configuration. (See below)

Vendor specific verbs are available to configure this pin. These verbs retain their values across link and single function group resets but are set to their default values by a power on reset:

MODE1	MODE0	EAPD Pin Function	Description
0	0	Open Drain I/O	Value at pin is wired-AND of EAPD bit and external signal. (default)
0	1	CMOS Output	Value of EAPD bit in pin widget is forced at pin
1	0	CMOS Input	External signal controls internal amps. EAPD bit in pin widget ignored
1	1	CMOS Input	External signal controls internal amps. EAPD bit in pin widget ignored

Control Flag	Description
EAPD PIN MODE 1:0	Defines if EAPD pin is used as input, output, or bi-directional port (Open Drain)
BTL/HP SD	0 = Amp controlled by EAPD pin only (default) / 1 = Amp controlled by power state (pin and FG) only
BTL/HP SD MODE	0 = Amp will mute when disabled. / 1 = Amp will shut down (enter a low power state) when disabled (default)
BTL/HP SD INV	0 = AMP will power down (or mute) when EAPD pin is low (default) / 1 = Amp will power down (or mute) when EAPD pin is high.

BTL SD	BTL SD MODE	BTL SD INV	EAPD Pin State	Amp State
0	0	0	0	Amplifier is mute
0	0	0	1	Amplifier is active
0	0	1	0	Amplifier is active
0	0	1	1	Amplifier is mute
0	1	0	0	Amplifier is in a low power state (default <sup>1</sup> )
0	1	0	1	Amplifier is active
0	1	1	0	Amplifier is active
0	1	1	1	Amplifier is in a low power state
1	0	NA	NA	Amplifier follows pin/function group power state and will mute when disabled
1	1	NA	NA	Amplifier follows pin/function group power state and will enter a low power state when disabled

Table 8. BTL Amp Status

1.EAPD bit is set to one by default but the EAPD state is 0 after power-on reset because the function group is not in D0. The state after a single or double function group reset will be compliant with ECR15b.

HP SD	HP SD MODE	HP SD INV	EAPD Pin State	Headphone Amp State
0	0	0	0	Amplifier is mute
0	0	0	1	Amplifier is active
0	0	1	0	Amplifier is active
0	0	1	1	Amplifier is mute
0	1	0	0	Amplifier is in a low power state (default <sup>1</sup> )
0	1	0	1	Amplifier is active
0	1	1	0	Amplifier is active
0	1	1	1	Amplifier is in a low power state
1	0	NA	NA	Amplifier follows pin/function group power state and will mute when disabled
1	1	NA	NA	Amplifier follows pin/function group power state and will enter a low power state when disabled

Table 9. Headphone Amp Enable Configuration

1.EAPD bit is set to one by default but the EAPD state is 0 after power-on reset because the function group is not in D0. The state after a single or double function group reset will be compliant with ECR15b.

BEEP Override	EAPD Pin value <sup>1</sup>	Description
0	Forced to low when in D2 or D3	Follows description in HD Audio spec. External amplifier is shut down when pin or function group power state is D2 or D3 independent of value in EAPD bit.
1	Always follows EAPD bit	Power state is ignored and EAPD pin follows EAPD bit value only to allow PC_Beep support in D2 and D3

Table 10. EAPD Low Power Behavior

1. When pin is enabled as Open Drain or CMOS output.

AFG Power State	RESET#	BEEP Override	EAPD Power State	Pin Behavior
D0-D3	Asserted (Low)	-	-	Active low immediately after power on, otherwise the previous state is retained across FG and link reset events
D0	De-Asserted (High)	-	-	Active - Pin reflects EAPD bit unless held low by external source.
D1	De-Asserted (High)	-	D0-D1	Active - Pin reflects EAPD bit unless held low by external source.
D2	De-Asserted (High)	Disabled	D0-D2	Pin forced low to disable external amp
D2	De-Asserted (High)	Enabled	D0-D2	Active - Pin reflects EAPD bit unless held low by external source.
D3	De-Asserted (High)	Disabled	D0-D3	Pin forced low to disable external amp
D3	De-Asserted (High)	Enabled	D0-D3	Active - Pin reflects EAPD bit unless held low by external source.
D3cold	De-Asserted (High)	-	-	Pin forced low to disable external amp
D4	De-Asserted (High)	-	-	Pin forced low to disable external amp
D5	De-Asserted (High)	-	-	Pin Hi-Z (off)

Table 11. EAPD Behavior

Figure 6. HP EAPD Example to be replaced by single pin for internal amp

HP AUDIO CONTROL BLOCK DIAGRAM

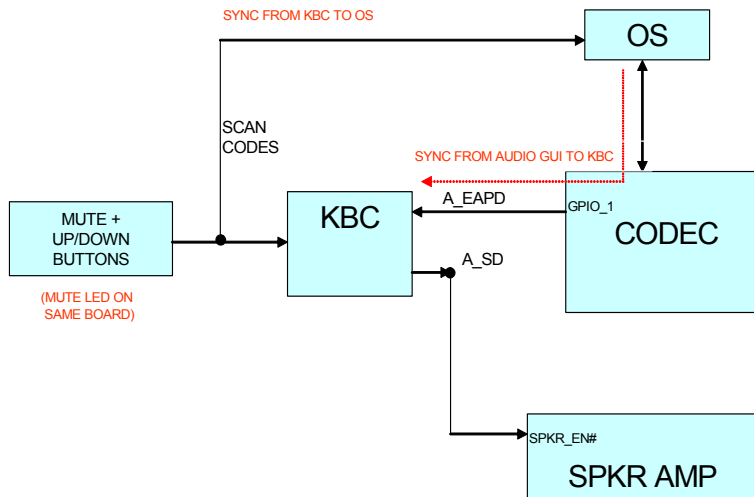



## 2.18. BTL Amplifier

An integrated class-AB stereo BTL amplifier is provided to directly drive 4 ohm speakers (2W @ 4.75V) or 8 ohm speakers (1W @ 4.75V). No external filter is needed for cable runs of 18" or less. An internal DC blocking filter prevents distortion when the audio source has DC content, and prevents unintentional power consumption when pausing audio playback. The amplifier may be controlled using the EAPD pin (see EAPD section.)

Using a vendor specific verb, the BTL amplifier may be configured to support a mono speaker connected to the L +/- pins. In this mode, the Left and Right audio is mixed and sent to the left output only. The right channel is turned off to conserve power.

The BTL amplifier includes thermal management circuitry. When the CODEC reaches a temperature of about 135 degrees, the output amplitude of the BTL amp is gradually lowered until the temperature falls below 135.

Maximum gain for the BTL amplifier is programmable. The following 4 gain settings relative to a nominal line output are desired: +6.5dB, +9.5dB, +14.5dB and +16.5dB. Absolute gain may vary and the suggested accuracy is +/-1.5dB. The gain is exposed in a vendor specific widget and is intended to mimic the pin programmable gain implemented in discrete BTL amplifiers commonly used in notebook computers.

## 2.19. BTL Amplifier High-Pass Filter

For mobile applications, speakers are often incapable of reproducing low frequency audio and unable to handle the maximum output power of the BTL amplifier. A high-pass filter is implemented in the DAC output path to reduce the amount of low frequency energy reaching speakers attached to the BTL amplifier. This can prevent speaker failure.

### 2.19.1. Filter Description

The high-pass filter is derived from the common biquadratic filter and provides a 12dB/octave roll-off. The filter may be programmed for a -3dB response at: 100Hz, 200Hz, 300Hz, 400Hz, 500Hz, 750Hz,

1KHz, or 2KHz. The high pass filter is enabled by default with a cut-off frequency of 300Hz. The filter may be bypassed using the associated verb (processing state verb).

The filter is implemented in digital before the Digital to Analog converter. There are 2 major consequences to implementing the filter in the digital domain:

1. All ports connected to the DAC will be affected by the high-pass filter when it is enabled.
2. Analog paths (such as when the microphone input is routed through the mixer to the BTL amplifier) are not affected.

Like the other analog inputs, PC\_Beep is not affected by the digital high-pass filter. To ensure that the speakers attached to the BTL amplifier are not harmed by low frequency audio entering the PC\_Beep input, an external filter must be implemented. Fortunately, it is common practice to implement an attenuation circuit and DC blocking capacitor at the PC\_Beep input. This attenuator/filter is easily adjusted to restrict low frequency audio. The easiest approach is to reduce the value of the DC blocking capacitor but other approaches are equally effective.

## 2.20. GPIO

### 2.20.1. GPIO Pin mapping and shared functions

GPIO #	Pin	Supply	SPDIF In	SPDIF Out	GPIO	GPIO	GPIO	VrefOut	DMIC	VOL	Pull Up	Pull Down
0	46	DVDD		YES	YES				IN			50K
1	2	DVDD			YES				CLK			50K
2	4	DVDD			YES				IN			50K

### 2.20.2. SPDIF/Digital Microphone/GPIO Selection

3 functions are available on the DMIC\_1/GPIO0/SPDIFOUT1 pin (pin 46). To determine which function is enabled, the order of precedence is followed:

3. If the GPIOs are enabled, they override both SPDIF\_OUT and Digital Mics
4. If the GPIOs are not enabled through the AFG, then at reset, the pin is pulled low by an internal pull-down resistor.
5. If the port is enabled as an input, the digital microphones will be used.
6. If the port is enabled as an output, the SPDIF output will be used.
7. In the event that the port is enabled as an input and an output, the port will be an output and the Digital Mic path will be mute.

### 2.20.3. Digital Microphone/GPIO Selection

2 functions are available on the DMIC\_CLK/GPIO1 (pin 2) and the DMIC\_0/GPIO2 (pin 4) pins. To determine which function is enabled, the order of precedence is followed:

1. If GPIOs are not enabled through the AFG, then at reset, pins 2 and 4 are pulled low by an internal pull-down resistor.
2. If the GPIO 1 is enabled, the 2 DMIC pins become mute (unless programmed for GPIO or SPDIF use) and pin 2 becomes an internal pull-down. If GPIO2 is enabled through the AFG, pin 4 becomes a GPIO and is pulled low by an internal pull-down resistor.
3. If the port is enabled as an input, the digital microphones will be used.



4. If the port is not enabled as an input or if the pin is configured as a GPIO, the digital microphone path will be mute.

## **2.21. HD Audio HDA015-B support**

Although HDA015-B is not yet complete (not a DCN), the 92HD81 will implement complete support for the specification building on the support already present in previous products. ECR 15b features supported are:

- Persistence of many configuration options through bus and function group reset.
- The ability to support port presence detect in D3 even when the HD Audio bus is in a low power state (no clock.)
- Fast resume times from low power states: 1ms D1 to D0, 2ms D2 to D0, 10mS D3 to D0.
- Notification if persistent register settings have been unexpectedly reset.
- SPDIF active in D3 (required)

## **2.22. Digital Core Voltage Regulator**

The digital core operates from 1.4 to 1.98V making it compatible with 1.5V (5%) and 1.8V (10%) supply voltages. Many systems require that the CODEC use a single 3.3V digital supply, so an integrated regulator is included on die. (Parts may be ordered with the regulator disabled). The regulator uses pin 9, DVDD, as its voltage source. The output of the LDO is connected to pin 1 and the digital core. A 10uF capacitor must be placed on pin 1 for proper load regulation and regulator stability.

The digital core voltage regulator is only dependent on DVDD. DVDDIO may be either 3.3 or 1.5V and may proceed or follow DVDD in sequence. The CODEC digital logic and I/O (unless referenced to AVDD) will operate in the absence of AVDD. DVDD and AVDD supply sequencing for the application of power and the removal of power is neither defined nor guaranteed. It is common for desktop systems to supply AVDD from the system standby supply and the CODEC will tolerate, indefinitely, the condition where AVDD is active but DVDD and DVDDIO are inactive.

To prevent pops, software is expected to mute paths as close to the port as is possible when changing power states or signal topology.

## 2.23. Aux Audio Support

See Orderable Part Numbers for which codecs offer this feature.

The codec supports an auxiliary audio mode where analog audio is supported by default after power is supplied with the HD Audio bus disabled. In this mode, an analog input is routed to one of several output ports depending on jack presence detection.

### 2.23.1. General conditions in Aux Audio Mode:

- HD Audio Link is off (RST# is 0, active, and BitClk is 0, inactive. CODEC does not need to monitor BitClk to enter/exit this mode but must not depend on BitClk to operate.)
- HD Audio CODEC analog and digital supplies are active.
- Port A may be an optional headphone jack (Normal and Aux Audio Mode) or an internal microphone port (Normal Mode only)
- Port B connects to the system headphone jack.
- Port D connects to the internal speakers.
- Port E is AUX Audio out
- Port F is AUX Audio In
- The internal digital microphone clock is controlled by a source external to the CODEC and the CODEC will use the DMIC\_CLK pin as a clock input. The DMIC0 input is used to process 1 or 2 digital microphone inputs. The expected clock is 3.072MHz.
- EAPD is used to control the power state of the mixer, BTL amplifier, and headphone amplifiers. The amplifiers are off if EAPD is held low.
- Internal circuitry will delay enabling (change power state, un-mute, etc.) the output amplifiers a sufficient amount of time after the application of power or EAPD=1 to prevent pops.
- Internal circuitry will orchestrate power down (EAPD = 0) to prevent pops.
- EAPD must be forced low before removing power.
- ECR15b considerations: Clock Stop OK or similar communication will be used to prevent problems when an OS driver attempts to put the HD Audio bus controller into D3 to save power. The bus must not be placed into reset with the clock stopped or unless EAPD is forced low or D3cold has been set. The Enable bit in the Aux Audio vendor specific verb is provided so firmware or other software can disable Aux Audio support and allow stopping the HD Audio bus when an OS is in an active state. The default value of this bit is determined by a bond option and may be determined by reading the device ID. This bit only returns to its default value when a power on reset event is generated.

### 2.23.2. "Playback Path" Port Behavior

Port F (Aux Audio In) input is routed to Port D ("internal speakers"), Ports A&B (system headphone ports), and Port E (Aux Audio Out) through the analog mixer.

2.23.2.1. When Port E Aux Audio Out presence detect = 0

- Presence detect for Port E = 0 (nothing plugged in)
- Port F Aux Audio input is routed to Port A, B, or D when that port is active.
- If either Port A or Port B is in use (port presence detect = 1), Port D, internal speakers, will be inactive (off)
- The power supply for Port A and B will be active if either A or B is in use but if only one of the two ports is in use, the other may be turned off to save power.
- If neither Port A nor Port B is in use (port presence detect = 0), Port D, internal speakers, will be active and ports A and B will be inactive.
- EAPD is used to indicate if AUX Audio Mode is in use.

2.23.2.2. When Port E Aux Audio Out presence detect = 1

- Presence detect for Port E = 1 (something plugged in)
- Port F Aux Audio input is routed to Ports A, B
- Port D is disabled
- If either Port A or Port B is in use (port presence detect = 1), that port will be enabled and output the audio entering Port F.
- The power supply for Port A and B will be active if either A or B is in use but if only one of the two ports is in use, the other may be turned off to save power.
- If neither Port A nor Port B is in use (port presence detect = 0), ports A and B will be inactive and the audio on Port F will play through the dock using resources outside of the CODEC.
- EAPD is used to indicate if AUX Audio Mode is in use.



EAPD (pin)	Aux Support Enable <sup>1</sup>	Port E detect	Port B detect	Port A detect	Port C, D, F, DMIC detect	Port D behavior	Port B behavior	Port A behavior
0	NA	NA	NA	NA	NA	disabled	disabled	disabled
1	0	NA	NA	NA	NA	Widget controlled	Widget controlled	Widget controlled
1	1	0	0	0	NA	enabled (F to mix to D)	disabled	disabled
1	1	0	0	1	NA	disabled	disabled	enabled (F to mix to A)
1	1	0	1	0	NA	disabled	enabled (F to mix to B)	disabled
1	1	0	1	1	NA	disabled	enabled (F to mix to B)	enabled (F to mix to A)
1	1	1	0	0	NA	disabled	disabled	disabled
1	1	1	0	1	NA	disabled	disabled	enabled (F to mix to A)
1	1	1	1	0	NA	disabled	enabled (F to mix to B)	disabled
1	1	1	1	1	NA	disabled	enabled (F to mix to B)	enabled (F to mix to A)

1.default value for Aux Audio Enable is determined by bond option.

### 2.23.3. "Record Path" Port Behavior

Digital Microphone input DMIC0 is used as an internal microphone port. The Digital Microphone clock pin is used as a clock input. The data on the DMIC0 pin is converted into analog audio using DAC 0 and sent to Port E (Aux Audio Out.) The expected clock input rate is 3.072MHz. Although this rate is not guaranteed, existing digital microphones are operated from about 1.5-3.2MHz. The CODEC does not provide gain for the digital microphone path in this mode and external gain of 20-30dB implemented at the output of Port E is expected for acceptable operation. Any DC offset from the digital microphone is removed by the AC coupling caps required on Port E.

If Port F presence detect = 0, this indicates that nothing is plugged into Aux Audio In and the digital microphone input is sent to port E. If Port F presence detect = 1, this indicates that an external source is plugged into the Aux Audio In. The DAC and Port E are disabled.



EAPD (pin)	Aux Support Enable <sup>1</sup>	D Mic detect	Port F detect	Ports A, B, C, D, E detect	Port E behavior
0	X	X	X	NA	disabled
1	0	X	X	NA	Widget controlled
1	1	1	0	NA	DMIC routed through CODEC DAC to port E. DMIC Clock provided from external source through DCLK pin. 3.072MHz typ.
1	1	1	1	NA	CODEC DAC and Port E disabled

1.default value for Aux Audio Enable is determined by bond option.

### 2.23.4. EAPD

Since the Aux Audio mode overrides the default behavior but not the actual port settings when in reset, the logical state of the EAPD pin must be overridden as well. When Aux Audio mode is enabled and the part is in reset as described above, the logical state of EAPD will be 1 (External Amplifier Powered Up) unless held low by an external circuit. This ensures that audio pass-thru and analog PC\_Beep will be supported.

### 2.23.5. Analog PC\_Beep

Analog PC\_Beep may be supported in Aux Audio mode. By default, analog PC\_Beep is disabled. If the CODEC is programmed to enable analog PC\_Beep and Aux Audio mode is enabled, the next time reset is asserted, the analog PC\_Beep pin will be mixed at each of the active outputs.

### 2.23.6. Firmware/Software Requirements:

If it is desirable to stop the HD Audio bus while the CODEC is in D3 under OS control per ECR-15b, Firmware must disable the AUX Audio Mode support in the CODEC prior to loading the OS. If Aux Audio Mode is not disabled in the CODEC, the CODEC will report to the OS driver that stopping the bus clock while the CODEC is in D3 is not supported or not available.

### 3. CHARACTERISTICS

#### 3.1. Electrical Specifications

##### 3.1.1. Absolute Maximum Ratings

Stresses above the ratings listed below can cause permanent damage to the 92HD81. These ratings, which are standard values for TSI commercially rated parts, are stress ratings only. Functional operation of the device at these or any other conditions above those indicated in the operational sections of the specifications is not implied. Exposure to absolute maximum rating conditions for extended periods can affect product reliability. Electrical parameters are guaranteed only over the recommended operating temperature range.

Item	Pin	Maximum Rating
Analog maximum supply voltage	AVdd	6 Volts
Digital maximum supply voltage	DVdd	5.5 Volts
VREFOUT output current		5 mA
Voltage on any pin relative to ground		Vss - 0.3 V to Vdd + 0.3 V
Operating temperature		0 °C to +70 °C
Storage temperature		-55 °C to +125 °C
Soldering temperature		Soldering temperature information for all available in the package section of this datasheet.

Table 12. Electrical Specification: Maximum Ratings

##### 3.1.2. Recommended Operating Conditions

Parameter		Min.	Typ.	Max.	Units
Power Supplies	DVDD_Core	1.4		1.98	V
	DVDD_IO (3.3V signaling)	3.135	3.3	3.465	V
	DVDD_IO (1.5V signaling)	1.418	1.5	1.583	V
Power Supply Voltage	Digital - 3.3 V	3.135	3.3	3.465	V
	(Note: With Supply Override Enable Bit set to force 5V operation.)				
	Analog - 4 V	3.8	4	4.2	V
	Analog - 4.5 V	4.51	4.75	4.99	V
	Analog - 5 V	4.75	5	5.25	V
Ambient Operating Temperature		0		+70	°C
Case Temperature	T <sub>case</sub> (48-QFN)			+95	°C

Table 13. Recommended Operating Conditions

**ESD:** The 92HD81 is an ESD (electrostatic discharge) sensitive device. The human body and test equipment can accumulate and discharge electrostatic charges up to 4000 Volts without detection. Even though the 92HD81 implements internal ESD protection circuitry, proper ESD precautions should be followed to avoid damaging the functionality or performance.

# 92HD81

## SINGLE CHIP PC AUDIO SYSTEM, CODEC+SPEAKER AMPLIFIER+CAPLESS HP+LDO

### 3.2. 92HD81 Analog Performance Characteristics

(Tambient = 25 °C, AVdd = Supply ± 5%, DVdd = 3.3V ± 5%, AVss=DVss=0V; 20Hz to 20KHz swept sinusoidal input; Sample Frequency = 48 kHz; 0 dB = 1 VRMS, 10KΩ//50pF load, Testbench Characterization BW: 20 Hz – 20 kHz, 0 dB settings on all gain stages)

Parameter	Conditions	AVdd	Min	Typ	Max	Unit
<b>Digital to Analog Converters</b>						
Resolution		All		24		Bits
Dynamic Range <sup>1</sup> : PCM to All Analog Outputs	-60dB FS signal level	5V 4.75V	93 93	100 100	-	dB
SNR <sup>2</sup> - DAC to All Mono/Line-Out Ports	Analog Mixer Disabled, PCM data	5V 4.75V	95 95			dB
THD+N <sup>3</sup> - DAC to All Mono/Line-Out Ports	Analog Mixer Disabled, 0/-1/-3dB FS Signal, PCM data	5V 4.75V	83 83			dBr
SNR <sup>2</sup> - DAC to All Headphone Ports	Analog Mixer Disabled, 10KΩ load, PCM data	5V 4.75V	95 95			dB
THD+N <sup>3</sup> - DAC to All Headphone Ports	Analog Mixer Disabled, 0/-1/-3dB FS Signal, 10KΩ load, PCM data	5V 4.75V	83 83			dBr
SNR <sup>2</sup> - DAC to All Headphone Ports	Analog Mixer Disabled, 32Ω load, PCM data	5V 4.75V	95 95			dB
THD+N <sup>3</sup> - DAC to All Headphone Ports	Analog Mixer Disabled, 0dB FS Signal, 32Ω load, PCM data	5V 4.75V	68 68			dBr
Any Analog Input (ADC) to DAC Crosstalk	10KHz Signal Frequency. 0dBV signal applied to ADC, DACs idle, ports enabled as output.	All	-65	-	-	dB
Any Analog Input (ADC) to DAC Crosstalk	1KHz Signal Frequency see above	All	-65	-	-	dB
DAC L/R crosstalk	DAC to LO or HP 20-15KHz into 10KΩ load	All	65			dB
DAC L/R crosstalk	DAC to HP 20-15KHz into 32Ω load	All	65			dB
Gain Error	Analog Mixer Disabled	All			0.5	dB
Interchannel Gain Mismatch	Analog Mixer Disabled	All			0.5	dB
D/A Digital Filter Pass Band <sup>4</sup>		All	20	-	21,000	Hz
D/A Digital Filter Pass Band Ripple <sup>5</sup>					0.1	+/- dB
D/A Digital Filter Transition Band		All	21,000	-	31,000	Hz
D/A Digital Filter Stop Band		All	31,000	-	-	Hz
D/A Digital Filter Stop Band Rejection <sup>6</sup>		All	-100	-	-	dB
D/A Out-of-Band Rejection <sup>7</sup>		All	-55	-	-	dB
Group Delay (48KHz sample rate)		All	-	-	1	ms
Attenuation, Gain Step Size DIGITAL		All	-	0.75	-	dB
DAC Offset Voltage		All	-	10	20	mV
Deviation from Linear Phase		All	-	1	10	deg.
<b>Analog Outputs</b>						

Table 14. 92HD81 Analog Performance Characteristics

# 92HD81

## SINGLE CHIP PC AUDIO SYSTEM, CODEC+SPEAKER AMPLIFIER+CAPLESS HP+LDO

Parameter	Conditions	AVdd	Min	Typ	Max	Unit
Full Scale All Mono/Line-Outs	DAC PCM Data	5V 4.75V	1.00 1.00	-	-	Vrms
Full Scale All Mono/Line-Outs	DAC PCM Data	5V 4.75V	2.83 2.83	-	-	Vp-p
All Headphone Capable Outputs	32Ω load	5V 4.75V	40 40	60 60	-	mW (peak)
Amplifier output impedance	Mono/Line Outputs Headphone Outputs	All		150 0.1		Ohms
External load Capacitance	Mono/Line Outputs Headphone Outputs			220		pF
<b>Analog inputs</b>						
Full Scale Input Voltage	0dB Boost @4.75V (input voltage required for 0dB FS output)	5V 4.75V	1.05	-	-	Vrms
All Analog Inputs with boost	10dB Boost	5V 4.75V	0.320	-	-	Vrms
All Analog Inputs with boost	20dB Boost	5V 4.75V	0.105	-	-	Vrms
All Analog Inputs with boost	30dB Boost	5V 4.75V	0.032	-	-	Vrms
Boost Gain Accuracy		All	-1			dB
Input Impedance		All	-	50	-	KΩ
Input Capacitance		All	-	15	-	pF
<b>Analog Mixer</b>						
Dynamic Range: PCM to All Analog Outputs	-60dB FS signal level Analog Beep enabled all other mixer inputs mute	5V 4.75V	93 93			
SNR <sup>2</sup> - All Line-Inputs to all Line Outputs	All inputs unmuted, single line input driven by ATE.	5V 4.75V	85 85	-		dB
THD+N <sup>3</sup> - All Line-Inputs to all Line Outputs	0dB Full Scale Input on one input, all others silent.	5V 4.75V	65 65	-		dBr
SNR <sup>2</sup> - DAC to All Line Outputs	Analog Mixer Enabled, PCM data, all others inputes mute.	5V 4.75V	93 93	-		dB
THD+N <sup>3</sup> - DAC to All Line-Out Ports	Analog Mixer Enabled, 0/-1/-3dB FS signal, PCM data, all others inputes unmute/silent	5V 4.75V	83 83			dBr
SNR <sup>2</sup> - DAC to All Ports	Analog Mixer Enabled, PCM data, all others inputes unmute/silent.	5V 4.75V	85 85	-		dB
THD+N <sup>3</sup> - DAC to All Ports	Analog Mixer Enabled, 0dB FS Signal, PCM data, all others inputes unmute/silent	5V 4.75V	75 75	-		dBr
Attenuation, Gain Step Size ANALOG		All	-	1.5	-	dB
<b>Analog to Digital Converter</b>						
Resolution		All		24		Bits

Table 14. 92HD81 Analog Performance Characteristics



# 92HD81

## SINGLE CHIP PC AUDIO SYSTEM, CODEC+SPEAKER AMPLIFIER+CAPLESS HP+LDO

Parameter	Conditions	AVdd	Min	Typ	Max	Unit
Full Scale Input Voltage	0dB Boost (input voltage required to generate 0dBFS per AES 17)	5V 4.75V	1.05 1.05			
Dynamic Range <sup>1</sup> , All Analog Inputs to A/D	High Pass Filter Enabled, -60dB FS, No boost	5V 4.75V	86 86	92 92		dB
SNR <sup>2</sup> - All Analog Inputs to A/D	High Pass Filter enabled	5V 4.75V	86 86	-		dB
Full Scale Input Voltage	20dB Boost (input voltage required to generate 0dBFS per AES 17)	5V 4.75V	0.105 0.105			
Dynamic Range <sup>1</sup> , All Analog Inputs to A/D	20dB Boost High Pass Filter Enabled, -60dB FS	5V 4.75V	81 81			
THD+N <sup>3</sup> All Analog Inputs to A/D	High Pass Filter enabled, -1/-3dB FS signal level	5V 4.75V	78 78			dB
THD+N <sup>3</sup> All Analog Inputs to A/D	20dB Boost, High Pass Filter enabled, -1/-3dB FS signal level	5V 4.75V	72 72			dB
Analog Frequency Response <sup>8</sup>		All	10	-	30,000	Hz
A/D Digital Filter Pass Band <sup>4</sup>		All	20	-	21,000	Hz
A/D Digital Filter Pass Band Ripple <sup>5</sup>		All			0.1	+/- dB
A/D Digital Filter Transition Band		All	21,000	-	31,000	Hz
A/D Digital Filter Stop Band		All	31,000	-	-	Hz
A/D Digital Filter Stop Band Rejection <sup>6</sup>		All	-100	-	-	dB
Group Delay	48 KHz sample rate	All	-	-	1	ms
Any unselected analog Input to ADC Crosstalk	10KHz Signal Frequency	All	-65	-	-	dB
Any unselected analog Input to ADC Crosstalk	1KHz Signal Frequency	All	-65	-	-	dB
ADC L/R crosstalk	Any selected input to ADC 20-15Khz	All	-65			dB
DAC to ADC crosstalk	DAC output 0dBFS. All outputs loaded. Input to ADC open. 20-15Khz	All	-65			dB
Spurious Tone Rejection <sup>9</sup>		All	-	-100	-	dB
Attenuation, Gain Step Size (analog)		All	-	1.5	-	dB
Interchannel Gain Mismatch ADC		All	-	-	0.5	dB
<b>Power Supply</b>						
Power Supply Rejection Ratio	10kHz	All	-	-60	-	dB
Power Supply Rejection Ratio	1kHz	All	-	-70	-	dB
D0 Didd <sup>10</sup>	3.3V, 1.8V, 1.5V			25		mA
D0 Aidd <sup>10</sup>	4.75V			60		mA
D0 Didd <sup>11</sup>	3.3V, 1.8V, 1.5V			20		mA
D0 Aidd <sup>11</sup>	4.75V			34		mA
D1 Didd <sup>12</sup>	3.3V, 1.8V, 1.5V			7		mA

Table 14. 92HD81 Analog Performance Characteristics

# 92HD81

## SINGLE CHIP PC AUDIO SYSTEM, CODEC+SPEAKER AMPLIFIER+CAPLESS HP+LDO

Parameter	Conditions	AVdd	Min	Typ	Max	Unit
D1 Aidd <sup>12</sup>	4.75V			30		mA
D2 Didd	3.3V, 1.8V, 1.5V			7		mA
D2 Aidd	4.75V			15		mA
D3 (Beep enabled) Didd <sup>13</sup>	3.3V, 1.8V, 1.5V			2		mA
D3 (Beep enabled) Aidd <sup>13</sup>	4.75V			10		mA
D3 Didd <sup>13</sup>	3.3V, 1.8V, 1.5V			2		mA
D3 Aidd <sup>13</sup>	4.75V			5		mA
D3cold Didd <sup>13</sup>	3.3V, 1.8V, 1.5V			1		mA
D3cold Aidd <sup>13</sup>	4.75V			5		mA
Vendor D4 Didd	3.3V, 1.8V, 1.5V			0.4		mA
Vendor D4 Aidd	4.75V			5		mA
Vendor D5 Didd	3.3V, 1.8V, 1.5V			0.4		mA
Vendor D5 Aidd	4.75V			0.6		mA
One Stereo ADC Didd	3.3V, 1.8V, 1.5V			4		mA
One Stereo ADC Aidd	4.75			8		mA
One Stereo DAC Didd	3.3V, 1.8V, 1.5V			4		mA
One Stereo DAC Aidd	4.75V			6		mA
<b>Voltage Reference Outputs</b>						
VREFOut <sup>14</sup>		All	-	0.5 X AVdd	-	V
VREFOut Drive		All		1.6		mA
VREFILT (VAG)		All		0.45 X AVdd		V
<b>Phased Locked Loop</b>						
PLL lock time		All		96	200	usec
PLL (or HD Audio Bit CLK) 24MHz clock jitter		All		150	500	psec
<b>ESD / Latchup</b>						
Latch-up	As described in JESD78A Class II	All		70		degC
ESD - Human Body Model	As described in JESD22-A114-B	All	2K	3K		V
Charged Device Model	As described in JESD22-C101	All	500	1K		V

**Table 14. 92HD81 Analog Performance Characteristics**

1. Dynamic Range is the ratio of the full scale signal to the noise output with a -60dBFS signal as defined in AES17 as SNR in the presence of signal and outlined in AES6id, measured "A weighted" over 20 Hz to 20 kHz bandwidth
2. Ratio of Full Scale signal to idle channel noise output is measured "A weighted" over a 20 Hz to a 20 kHz bandwidth. (AES17-1991 Idle Channel Noise or EIAJ CP-307 Signal-to-noise Ratio).
3. THD+N ratio as defined in AES17 and outlined in AES6id, non-weighted, over 20 Hz to 20 kHz bandwidth. Results at the jack are dependent on external components and will likely be 1 - 2dB worse.
4. Peak-to-Peak Ripple over Passband meets  $\pm 0.125$ dB limits, 48 kHz or 44.1 kHz Sample Frequency. 1dB limit.
5. Peak-to-Peak Ripple over Passband meets  $\pm 0.125$ dB limits, 48 kHz or 44.1 kHz Sample Frequency. 1dB limit.
6. Stop Band rejection determines filter requirements. Out-of-Band rejection determines audible noise.
7. The integrated Out-of-Band noise generated by the DAC process, during normal PCM audio playback, over a bandwidth 28.8 to 100 kHz, with respect to a 1 Vrms DAC output.
8.  $\pm 1$  dB limits for Line Output & 0 dB gain, at -20dBV

- 9. Spurious tone rejection is tested with ADC dither enabled and compared to ADC performance without dither.
- 10. All functions/converters active, pin complexes enabled, two FDX streams, line (10Kohm) loads. Add 24mA analog current per stereo 32 ohm headphone.
- 11. One stereo DAC and corresponding pin widgets enabled (playback mode)
- 12. Mixer enabled
- 13. Idle measurement D3 set for minimum clicks/pops (biases and min. amps. on)
- 14. Can be set to 0.5 or 0.8 AVdd.

### 3.3. AC Timing Specs

#### 3.3.1. HD Audio Bus Timing

Parameter	Definition	Symbol	Min	Typ	Max	Units
BCLK Frequency	Average BCLK frequency		23.997 6	24.0	24.002 4	Mhz
BCLK Period	Period of BCLK including jitter	T <sub>cyc</sub>	41.163	41.67	42.171	ns
BCLK High Phase	High phase of BCLK	T <sub>high</sub>	17.5		24.16	ns
BCLK Low Phase	Low phase of BCLK	T <sub>low</sub>	17.5		24.16	ns
BCLK jitter	BCLK jitter			150	500	ps
SDI delay	Time after rising edge of BCLK that SDI becomes valid	T <sub>tco</sub>	3		11	ns
SDO setup	Setup for SDO at both rising and falling edges of BCLK	T <sub>su</sub>	5			ns
SDO hold	Hold for SDO at both rising and falling edges of BCLK	T <sub>h</sub>	5			ns

Table 15. HD Audio Bus Timing

Figure 7. HD Audio Bus Timing



**3.3.2. SPDIF Timing**

Parameter	Definition	Symbol	Min	Typ	Max	Units
SPDIF_OUT Frequency	highest rate of encoded signal 64 times the sample rate		2.8224	3.072	12.288	MHz
SPDIF_OUT unit interval	1/(128 times the sample rate)	UI	177.15	162.76	40.69	ns
SPDIF_OUT jitter	SPDIF_OUT jitter				4.43	ns
SPDIF_OUT rise time		T <sub>rise</sub>			15	ns
SPDIF_OUT fall time		T <sub>fall</sub>			15	ns

Table 16. SPDIF Timing

**3.3.3. Digital Microphone Timing**

Parameter	Definition	Symbol	Min	Typ	Max	Units
DMIC_CLK Frequency	Average DMIC_CLK frequency		1.176	2.352	4.704	MHz
DMIC_CLK Period	Period of DMIC_CLK	T <sub>dmic_cyc</sub>	850.34	425.17	212.59	ns
DMIC_CLK jitter	DMIC_CLK jitter				5000	ps
DMIC Data setup	Setup for the microphone data at both rising and falling edges of DMIC_CLK	T <sub>dmic_su</sub>	5			ns
DMIC Data hold	Hold for the microphone data at both rising and falling edges of DMIC_CLK	T <sub>dmic_h</sub>	5			ns

Table 17. Digital Mic timing

**3.3.4. Class-AB BTL Amplifier Performance**

Parameter	Min	Typ	Max	Unit
Output Power (BTL 4 ohm, 5V - Continuous Average Power))	2			W
Output Power (BTL 8 ohm, 5V - Continuous Average Power))	1			W
Amplifier Efficiency $\eta$ (4 $\Omega$ , 5V, 2W) <sup>1</sup>			60	%
THD+N (BTL 4 or 8 ohm, 5V, FS)			1	%
Frequency Response	20	-	20K	Hz
Output voltage noise		50		$\mu$ V
shutdown current		0.6		mA

Table 18. Class-AB BTL Amplifier Performance

1. Amplifier efficiency includes circuits specific to the BTL amplifier audio path such as temperature limit, short circuit, and other support circuits.

**3.3.5. Capless Headphone Supply Characteristics**

Parameter	Min	Typ	Max	Unit
LDO idle current		1	2	mA
Cap-less Headphone Amp idle current		2	3	
Charge Pump idle current		4	6	mA
Charge Pump shutdown time		1		mS
Charge Pump start-up time		10		mS
Frequency		384		KHz
C1/C2 cap value		2.2		uF

**Table 19. Capless Headphone Supply**

4. FUNCTIONAL BLOCK DIAGRAMS

Port C is input only on the TA revision. RA revision is output capable.



Figure 8. Functional Block Diagram

5. WIDGET INFORMATION AND SUPPORTED COMMAND VERBS



Figure 9. Widget Diagram

6. PORT CONFIGURATIONS

6.1. Suggested Desktop Configurations

Desktop 1



Desktop 3

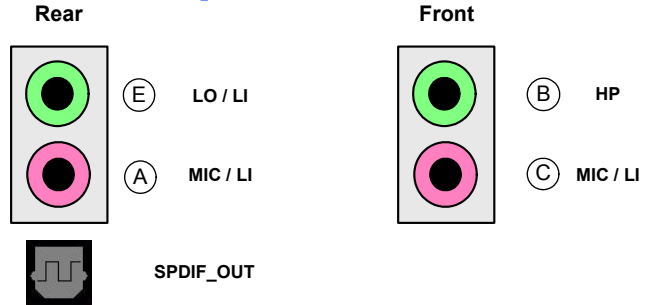

Desktop 2



Desktop 4

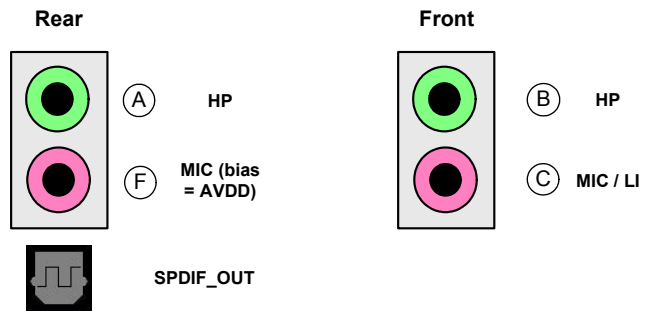

Figure 10. Desktop Port Configurations



6.2. Suggested Mobile Port Configurations

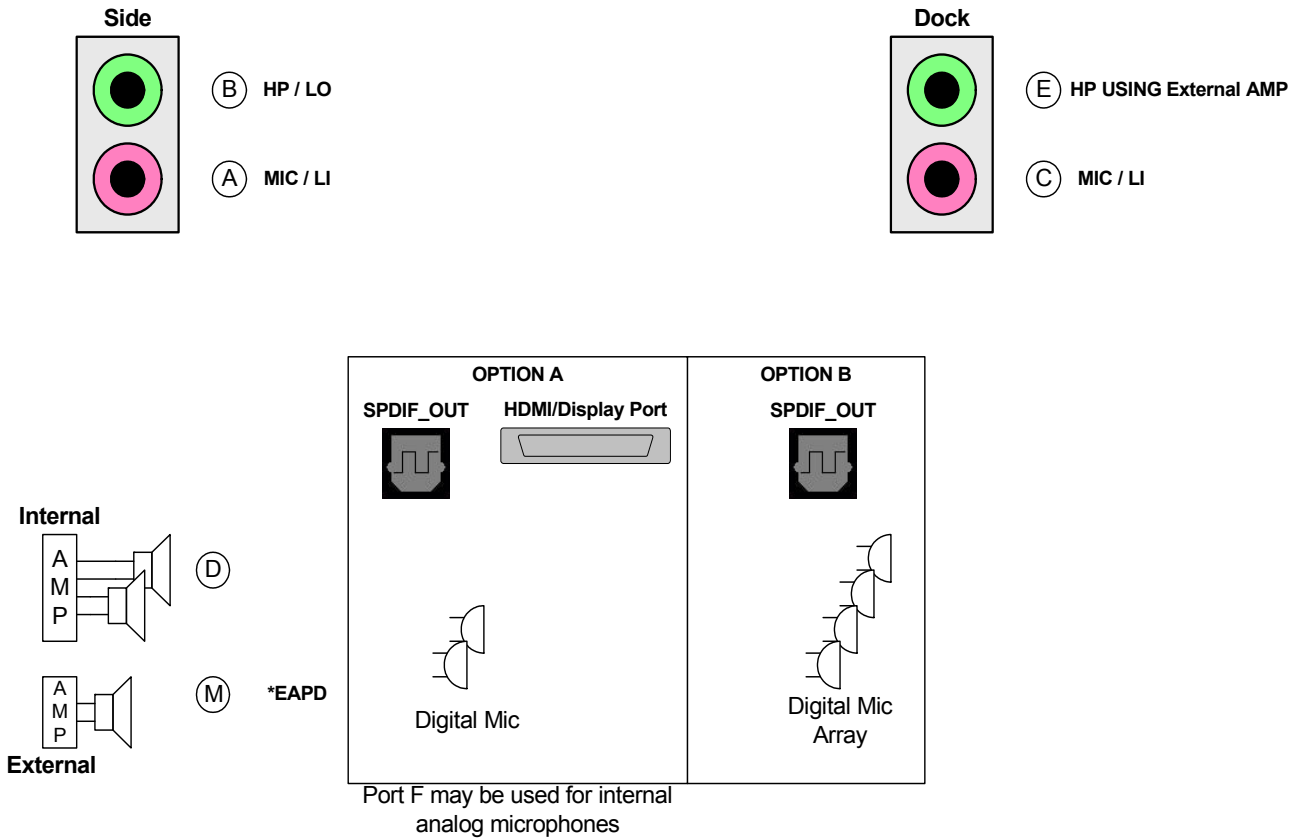

Figure 11. Port Configuration

### 6.3. Pin Configuration Default Register Settings

The following table shows the Pin Widget Configuration Default settings. Mobile 3-jack implementation with 3 HP jacks in front and 2 jacks in rear. The internal speaker is redirected from the front (green) headphone jack, while the other (black) headphone jack and microphone jack may be used for RTC.

Pin Name	Port	Location	Device	Connection	Color	Misc	Pin Name	Port
PortAPin	Connect to Jack 00b	Mainboard Front 2h	HP Out 2h	1/8 inch Jack 1h	Green 4h	Jack Detect Override=0	3h	Fh
PortBPin	Connect to Jack 00b	Mainboard Front 2h	HP Out 2h	1/8 inch Jack 1h	Black 1h	Jack Detect Override=0	1h	0h
PortCPin	Connect to Jack 00b	Mainboard Front 2h	Mic In Ah	1/8 inch Jack 1h	Pink 9h	Jack Detect Override=0	2h	0h
PortDPin	Internal 10b	NA 010000b	Speaker 1h	Other Analog 7h	Unknown 0h	Jack Detect Override=0	3h	0h
PortEPin*	Connect to Jack 00b	Mainboard Rear 1h	Line In 8h	1/8 inch Jack 1h	Green 4h	Jack Detect Override=0	5h	0h
PortFPin	Connect to Jack 00b	Mainboard Rear 1h	Line In 8h	1/8 inch Jack 1h	Pink 9h	Jack Detect Override=0	4h	0h
MonoOutPin	Internal 10b	Internal 010000b	Other Fh	Unknown 0h	Unknown 0h	Jack Detect Override=0	8h	0h
DigOutPin0	Connect to Jack 00b	Mainboard Rear 000001b	SPDIF Out 4h	optical 5h	Black 1h	Jack Detect Override=1	6h	0h
DigOutPin1	Connect to Jack 10b	Internal 011000b	Digital Other Out 5h	Other Digital 6h	Unknown 0h	Jack Detect Override=1	7h	0h
DigMic0Pin	Internal 10b	Internal 010000b	Mic In Ah	ATAPI 3h	Unknown 0h	Jack Detect Override=0	4h	1h

**Table 20. Pin Configuration Default Settings**

\*Revision YB & prior, Port E configuration was device = 0h Line Out.

## 7. WIDGET INFORMATION

Bits [39:32]	Bits [31:28]	BITS [27:20]	BITS[19:16]	BITS [15:0]
Reserved	CODEC Address	NID	Verb ID (4-bit)	Payload Data (16-bit)

Table 21. Command Format for Verb with 4-bit Identifier

Bits [39:32]	Bits [31:28]	BITS [27:20]	BITS[19:8]	BITS [7:0]
Reserved	CODEC Address	NID	Verb ID (12-bit)	Payload Data (8-bit)

Table 22. Command Format for Verb with 12-bit Identifier

There are two types of responses: Solicited and Unsolicited. Solicited responses are provided as a direct response to an issued command and will be provided in the frame immediately following the command. Unsolicited responses are provided by the CODEC independent of any command. Unsolicited responses are the result of CODEC events such as a jack insertion detection. The formats for Solicited Responses and Unsolicited Responses are shown in the tables below. The “Tag” field in bits [31:28] of the Unsolicited Response identify the event.

Bit [35]	Bit [34]	BITS [33:32]	BITS[31:0]
Valid (Valid = 1)	UnSol = 0	Reserved	Response

Table 23. Solicited Response Format

Bit [35]	Bit [34]	BITS [33:32]	BITS[31:28]	BITS [27:0]
Valid (Valid = 1)	UnSol = 1	Reserved	Tag	Response

Table 24. Unsolicited Response Format

### 7.1. Widget List

ID	Widget Name	Description
00h	Root	Root Node
01h	AFG	Audio Function Group
0Ah	Port A	Port A Pin Widget (Capless Headphone)
0Bh	Port B	Port B Pin Widget (Capless Headphone)
0Ch	Port C	Port C Pin Widget (Line IN/OUT, MIC) (Line IN, MIC for TA revision only)
0Dh	Port D	Port D Pin Widget (BTL output - EAPD control)
0Eh	Port E	Port E Pin Widget (Line IN/OUT)
0Fh	Port F	Port F Pin Widget (Line IN/OUT, MIC)
10h	MonoOut	MonoOut Pin Widget (output only)
11h	DigMic0	Digital Microphone 0 Pin Widget
12h	DigMic1 Vol	Vendor Specific Widget - D-Mic1 volume
13h	DAC0	Stereo Output Converter to DAC

Table 25. High Definition Audio Widget

ID	Widget Name	Description
14h	DAC1	Stereo Output Converter to DAC
15h	ADC0	Stereo Input Converter to ADC
16h	ADC1	Stereo Input Converter to ADC
17h	ADC0Mux	ADC0 Mux with volume and mute
18h	ADC1Mux	ADC1 Mux with volume and mute
19h	Mono Mux	Mono output source select
1Ah	Mono Mix	Stereo to mono conversion
1Bh	Mixer	Input Mixer (Input Ports, DACs, Analog PC_Beep)
1Ch	MixerOutVol	Volume control for analog mixer
1Dh	SPDIFOut0	Stereo Output for SPDIF_Out
1Eh	SPDIFOut1	Second Stereo Output for SPDIF_Out
1Fh	Dig0Pin	First Digital Output Pin (pin48)
20h	Dig1Pin	Second Digital Output Pin / DMIC Input Pin (pin 46)
21h	DigBeep	Digital PC Beep
22h	DAC2	Stereo Output Converter to DAC

Table 25. High Definition Audio Widget

### 7.2. Reset Key

Abbreviation	Description
POR	Power On Reset.
SAFG	Single AFG Reset - One single write to the Reset Verb in the AFG Node.
DAFG	Double AFG Reset - Two consecutive Single AFG Resets with only idle frames (if any) and no Link Resets between.
S&DAFG	Single And Double AFG Reset - Either one will cause reset.
LR	Link Reset - Level sensitive reset anytime the HDA Reset is set low.
ELR	Exiting Link Reset - Edge sensitive reset any time the HDA Reset transitions from low to high.
ULR	Unexpected Link Reset - Level sensitive reset anytime the HDA Reset is set low when the ClkStopOK indicator is currently set to 0.
PS	Power State Change - Reset anytime the Actual Power State changes for the Widget in question.

### 7.3. Root (NID = 00h): VendorID

Reg	Byte 4 (Bits 31:24)	Byte 3 (Bits 23:16)	Byte 2 (Bits 15:8)	Byte 1 (Bits 7:0)
Set				
Get	F0000h			

Field Name	Bits	R/W	Default	Reset
Vendor	31:16	R	111Dh	N/A
	Vendor ID.			
DeviceFix	15:8	R	see below	N/A
	Device ID.			
DeviceProg	7:0	R	see below	N/A
	Device ID.			

Device	92HD81B1A, 92HD81B1X (Aux Mode enabled)	92HD81B1B, 92HD81B1C
Device ID	7605h	76D5h

**7.3.1. Root (NID = 00h): RevID**

Reg	Byte 4 (Bits 31:24)	Byte 3 (Bits 23:16)	Byte 2 (Bits 15:8)	Byte 1 (Bits 7:0)
Set				
Get	F0002h			

Field Name	Bits	R/W	Default	Reset
Rsvd	31:24	R	00h	N/A (Hard-coded)
	Reserved.			
Major	23:20	R	1h	N/A (Hard-coded)
	Major rev number of compliant HD Audio spec.			
Minor	19:16	R	0h	N/A (Hard-coded)
	Minor rev number of compliant HD Audio spec.			
RevisionFix	15:12	R	xh	N/A (Hard-coded)
	Vendor's rev number for this device.			
RevisionProg	11:8	R	xh	N/A (Hard-coded)
	Vendor's rev number for this device.			
SteppingFix	7:4	R	xh	N/A (Hard-coded)
	Vendor stepping number within the Vendor RevID.			
SteppingProg	3:0	R	xh	N/A (Hard-coded)
	Vendor stepping number within the Vendor RevID.			

**7.3.2. Root (NID = 00h): NodeInfo**

Reg	Byte 4 (Bits 31:24)	Byte 3 (Bits 23:16)	Byte 2 (Bits 15:8)	Byte 1 (Bits 7:0)
Set				
Get	F0004h			

Field Name	Bits	R/W	Default	Reset
Rsvd2	31:24	R	00h	N/A (Hard-coded)
	Reserved.			

Field Name	Bits	R/W	Default	Reset
StartNID	23:16	R	01h	N/A (Hard-coded)
	Starting node number (NID) of first function group			
Rsvd1	15:8	R	00h	N/A (Hard-coded)
	Reserved.			
TotalNodes	7:0	R	01h	N/A (Hard-coded)
	Total number of nodes			

#### 7.4. AFG (NID = 01h): NodeInfo

Reg	Byte 4 (Bits 31:24)	Byte 3 (Bits 23:16)	Byte 2 (Bits 15:8)	Byte 1 (Bits 7:0)
Set				
Get	F0004h			

Field Name	Bits	R/W	Default	Reset
Rsvd2	31:24	R	00h	N/A (Hard-coded)
	Reserved.			
StartNID	23:16	R	0Ah	N/A (Hard-coded)
	Starting node number for function group subordinate nodes.			
Rsvd1	15:8	R	00h	N/A (Hard-coded)
	Reserved.			
TotalNodes	7:0	R	19h	N/A (Hard-coded)
	Total number of nodes.			

##### 7.4.1. AFG (NID = 01h): FGType

Reg	Byte 4 (Bits 31:24)	Byte 3 (Bits 23:16)	Byte 2 (Bits 15:8)	Byte 1 (Bits 7:0)
Set				
Get	F0005h			

Field Name	Bits	R/W	Default	Reset
Rsvd	31:9	R	000000h	N/A (Hard-coded)
	Reserved.			
UnSol	8	R	1h	N/A (Hard-coded)
	Unsolicited response supported: 1 = yes, 0 = no.			
NodeType	7:0	R	1h	N/A (Hard-coded)
	Function group type: 00h = Reserved 01h = Audio Function Group 02h = Vendor Defined Modem Function Group 03h-7Fh = Reserved 80h-FFh = Vendor Defined Function Group			

#### 7.4.2. AFG (NID = 01h): AFGCap

Reg	Byte 4 (Bits 31:24)	Byte 3 (Bits 23:16)	Byte 2 (Bits 15:8)	Byte 1 (Bits 7:0)
Set				
Get	F0008h			

Field Name	Bits	R/W	Default	Reset
Rsvd3	31:17	R	00h	N/A (Hard-coded)
	Reserved.			
BeepGen	16	R	1h	N/A (Hard-coded)
	Beep generator present: 1 = yes, 0 = no.			
Rsvd2	15:12	R	0h	N/A (Hard-coded)
	Reserved.			
InputDelay	11:8	R	Dh	N/A (Hard-coded)
	Typical latency in frames. Number of samples between when the sample is received as an analog signal at the pin and when the digital representation is transmitted on the HD Audio link.			
Rsvd1	7:4	R	0h	N/A (Hard-coded)
	Reserved.			



Field Name	Bits	R/W	Default	Reset
OutputDelay	3:0	R	Dh	N/A (Hard-coded)
	Typical latency in frames. Number of samples between when the signal is received from the HD Audio link and when it appears as an analog signal at the pin.			

### 7.4.3. AFG (NID = 01h): PCMCap

Reg	Byte 4 (Bits 31:24)	Byte 3 (Bits 23:16)	Byte 2 (Bits 15:8)	Byte 1 (Bits 7:0)
Set				
Get	F000Ah			

Field Name	Bits	R/W	Default	Reset
Rsvd2	31:21	R	000h	N/A (Hard-coded)
	Reserved.			
B32	20	R	0h	N/A (Hard-coded)
	32 bit audio format support: 1 = yes, 0 = no.			
B24	19	R	1h	N/A (Hard-coded)
	24 bit audio format support: 1 = yes, 0 = no.			
B20	18	R	1h	N/A (Hard-coded)
	20 bit audio format support: 1 = yes, 0 = no.			
B16	17	R	1h	N/A (Hard-coded)
	16 bit audio format support: 1 = yes, 0 = no.			
B8	16	R	0h	N/A (Hard-coded)
	8 bit audio format support: 1 = yes, 0 = no.			
Rsvd1	15:12	R	0h	N/A (Hard-coded)
	Reserved.			
R12	11	R	0h	N/A (Hard-coded)
	384kHz rate support: 1 = yes, 0 = no.			
R11	10	R	1h	N/A (Hard-coded)
	192kHz rate support: 1 = yes, 0 = no.			

# 92HD81

## SINGLE CHIP PC AUDIO SYSTEM, CODEC+SPEAKER AMPLIFIER+CAPLESS HP+LDO

Field Name	Bits	R/W	Default	Reset
R10	9	R	0h	N/A (Hard-coded)
	176.4kHz rate support: 1 = yes, 0 = no.			
R9	8	R	1h	N/A (Hard-coded)
	96kHz rate support: 1 = yes, 0 = no.			
R8	7	R	1h	N/A (Hard-coded)
	88.2kHz rate support: 1 = yes, 0 = no.			
R7	6	R	1h	N/A (Hard-coded)
	48kHz rate support: 1 = yes, 0 = no.			
R6	5	R	1h	N/A (Hard-coded)
	44.1kHz rate support: 1 = yes, 0 = no.			
R5	4	R	0h	N/A (Hard-coded)
	32kHz rate support: 1 = yes, 0 = no.			
R4	3	R	0h	N/A (Hard-coded)
	22.05kHz rate support: 1 = yes, 0 = no.			
R3	2	R	0h	N/A (Hard-coded)
	16kHz rate support: 1 = yes, 0 = no.			
R2	1	R	0h	N/A (Hard-coded)
	11.025kHz rate support: 1 = yes, 0 = no.			
R1	0	R	0h	N/A (Hard-coded)
	8kHz rate support: 1 = yes, 0 = no.			

### 7.4.4. AFG (NID = 01h): StreamCap

Reg	Byte 4 (Bits 31:24)	Byte 3 (Bits 23:16)	Byte 2 (Bits 15:8)	Byte 1 (Bits 7:0)
Set				
Get	F000Bh			

Field Name	Bits	R/W	Default	Reset
Rsvd	31:3	R	00000000h	N/A (Hard-coded)
	Reserved.			
AC3	2	R	0h	N/A (Hard-coded)
	AC-3 formatted data support: 1 = yes, 0 = no.			
Float32	1	R	0h	N/A (Hard-coded)
	Float32 formatted data support: 1 = yes, 0 = no.			
PCM	0	R	1h	N/A (Hard-coded)
	PCM-formatted data support: 1 = yes, 0 = no.			

#### 7.4.5. AFG (NID = 01h): InAmpCap

Reg	Byte 4 (Bits 31:24)	Byte 3 (Bits 23:16)	Byte 2 (Bits 15:8)	Byte 1 (Bits 7:0)
Set				
Get	F000Dh			

Field Name	Bits	R/W	Default	Reset
Mute	31	R	0h	N/A (Hard-coded)
	Mute support: 1 = yes, 0 = no.			
Rsvd3	30:23	R	00h	N/A (Hard-coded)
	Reserved.			
StepSize	22:16	R	27h	N/A (Hard-coded)
	Size of each step in the gain range: 0 to 127 = .25dB to 32dB, in .25dB steps.			
Rsvd2	15	R	0h	N/A (Hard-coded)
	Reserved.			
NumSteps	14:8	R	03h	N/A (Hard-coded)
	Number of gains steps (number of possible settings - 1).			
Rsvd1	7	R	0h	N/A (Hard-coded)
	Reserved.			

Field Name	Bits	R/W	Default	Reset
Offset	6:0	R	00h	N/A (Hard-coded)
Indicates which step is 0dB				

#### 7.4.6. AFG (NID = 01h): PwrStateCap

Reg	Byte 4 (Bits 31:24)	Byte 3 (Bits 23:16)	Byte 2 (Bits 15:8)	Byte 1 (Bits 7:0)
Set				
Get	F000Fh			

Field Name	Bits	R/W	Default	Reset
EPSS	31	R	1h	N/A (Hard-coded)
Extended power states support: 1 = yes, 0 = no.				
ClkStop	30	R	1h	N/A (Hard-coded)
D3 clock stop support: 1 = yes, 0 = no.				
S3D3ColdSup	29	R	1h	N/A (Hard-coded)
Codec state intended during system S3 state: 1 = D3Hot, 0 = D3Cold. On YB revs & prior, this was called LPD3Sup & default was 0h				
Rsvd	28:5	R	000000h	N/A (Hard-coded)
Reserved.				
D3ColdSup	4	R	1h	N/A (Hard-coded)
D3Cold power state support: 1 = yes, 0 = no.				
D3Sup	3	R	1h	N/A (Hard-coded)
D3 power state support: 1 = yes, 0 = no.				
D2Sup	2	R	1h	N/A (Hard-coded)
D2 power state support: 1 = yes, 0 = no.				
D1Sup	1	R	1h	N/A (Hard-coded)
D1 power state support: 1 = yes, 0 = no.				
D0Sup	0	R	1h	N/A (Hard-coded)
D0 power state support: 1 = yes, 0 = no.				

**7.4.7. AFG (NID = 01h): GPIOCnt**

Reg	Byte 4 (Bits 31:24)	Byte 3 (Bits 23:16)	Byte 2 (Bits 15:8)	Byte 1 (Bits 7:0)
Set				
Get	F0011h			

Field Name	Bits	R/W	Default	Reset
GPIWake	31	R	1h	N/A (Hard-coded)
	Wake capability. Assuming the Wake Enable Mask controls are enabled, GPIO's configured as inputs can cause a wake (generate a Status Change event on the link) when there is a change in level on the pin.			
GPIUnsol	30	R	1h	N/A (Hard-coded)
	GPIO unsolicited response support: 1 = yes, 0 = no.			
Rsvd	29:24	R	00h	N/A (Hard-coded)
	Reserved.			
NumGPIs	23:16	R	00h	N/A (Hard-coded)
	Number of GPI pins supported by function group.			
NumGPOs	15:8	R	00h	N/A (Hard-coded)
	Number of GPO pins supported by function group.			
NumGPIOs	7:0	R	03h	N/A (Hard-coded)
	Number of GPIO pins supported by function group.			

**7.4.8. AFG (NID = 01h): OutAmpCap**

Reg	Byte 4 (Bits 31:24)	Byte 3 (Bits 23:16)	Byte 2 (Bits 15:8)	Byte 1 (Bits 7:0)
Set				
Get	F0012h			

Field Name	Bits	R/W	Default	Reset
Mute	31	R	1h	N/A (Hard-coded)
	Mute support: 1 = yes, 0 = no.			

Field Name	Bits	R/W	Default	Reset
Rsvd3	30:23	R	00h	N/A (Hard-coded)
	Reserved.			
StepSize	22:16	R	02h	N/A (Hard-coded)
	Size of each step in the gain range: 0 to 127 = .25dB to 32dB, in .25dB steps.			
Rsvd2	15	R	0h	N/A (Hard-coded)
	Reserved.			
NumSteps	14:8	R	7Fh	N/A (Hard-coded)
	Number of gains steps (number of possible settings - 1).			
Rsvd1	7	R	0h	N/A (Hard-coded)
	Reserved.			
Offset	6:0	R	7Fh	N/A (Hard-coded)
	Indicates which step is 0dB			

**7.4.9. AFG (NID = 01h): PwrState**

Reg	Byte 4 (Bits 31:24)	Byte 3 (Bits 23:16)	Byte 2 (Bits 15:8)	Byte 1 (Bits 7:0)
Set				705h
Get	F0500h			

Field Name	Bits	R/W	Default	Reset
Rsvd3	31:11	R	000000h	N/A (Hard-coded)
	Reserved.			
SettingsReset	10	R	1h	POR - DAFG - ULR
	Indicates if any persistent settings in this Function Group have been reset. Cleared by PwrState 'Get' to this Widget.			
ClkStopOK	9	R	1h	POR - DAFG - ULR
	Bit clock can currently be removed: 1 = yes, 0 = no.			
Error	8	R	0h	POR - DAFG - ULR
	Error indicator: 1 = cannot enter requested power state, 0 = no problem with requested power state.			

Field Name	Bits	R/W	Default	Reset
Rsvd2	7	R	0h	N/A (Hard-coded)
	Reserved.			
Act	6:4	R	3h	POR - DAFG - LR
	Actual power state of this widget.			
Rsvd1	3	R	0h	N/A (Hard-coded)
	Reserved.			
Set	2:0	RW	3h	POR - DAFG - LR
	Current power state setting for this widget.			

#### 7.4.10. AFG (NID = 01h): UnsolResp

Reg	Byte 4 (Bits 31:24)	Byte 3 (Bits 23:16)	Byte 2 (Bits 15:8)	Byte 1 (Bits 7:0)
Set				708h
Get	F0800h			

Field Name	Bits	R/W	Default	Reset
Rsvd2	31:8	R	000000h	N/A (Hard-coded)
	Reserved.			
En	7	RW	0h	POR - DAFG - ULR
	Unsolicited response enable: 1 = enabled, 0 = disabled.			
Rsvd1	6	R	0h	N/A (Hard-coded)
	Reserved.			
Tag	5:0	RW	00h	POR - DAFG - ULR
	Software programmable field returned in top six bits (31:26) of every Unsolicited Response generated by this node.			

#### 7.4.11. AFG (NID = 01h): GPIO

Reg	Byte 4 (Bits 31:24)	Byte 3 (Bits 23:16)	Byte 2 (Bits 15:8)	Byte 1 (Bits 7:0)
Set				715h
Get	F1500h			

Field Name	Bits	R/W	Default	Reset
Rsvd	31:3	R	00000000h	N/A (Hard-coded)
	Reserved.			
Data2	2	RW	0h	POR - DAFG - ULR
	Data for GPIO2. If this GPIO bit is configured as Sticky (edge-sensitive) input, it can be cleared by writing "0". For details of read back value, refer to HD Audio spec. section 7.3.3.22			
Data1	1	RW	0h	POR - DAFG - ULR
	Data for GPIO1. If this GPIO bit is configured as Sticky (edge-sensitive) input, it can be cleared by writing "0". For details of read back value, refer to HD Audio spec. section 7.3.3.22			
Data0	0	RW	0h	POR - DAFG - ULR
	Data for GPIO0. If this GPIO bit is configured as Sticky (edge-sensitive) input, it can be cleared by writing "0". For details of read back value, refer to HD Audio spec. section 7.3.3.22			

#### 7.4.12. AFG (NID = 01h): GPIOEn

Reg	Byte 4 (Bits 31:24)	Byte 3 (Bits 23:16)	Byte 2 (Bits 15:8)	Byte 1 (Bits 7:0)
Set				716h
Get	F1600h			

Field Name	Bits	R/W	Default	Reset
Rsvd	31:3	R	00000000h	N/A (Hard-coded)
	Reserved.			
Mask2	2	RW	0h	POR - DAFG - ULR
	Enable for GPIO2: 0 = pin is disabled (Hi-Z state); 1 = pin is enabled; behavior determined by GPIO Direction control			
Mask1	1	RW	0h	POR - DAFG - ULR
	Enable for GPIO1: 0 = pin is disabled (Hi-Z state); 1 = pin is enabled; behavior determined by GPIO Direction control			
Mask0	0	RW	0h	POR - DAFG - ULR
	Enable for GPIO0: 0 = pin is disabled (Hi-Z state); 1 = pin is enabled; behavior determined by GPIO Direction control			



**7.4.13. AFG (NID = 01h): GPIODir**

Reg	Byte 4 (Bits 31:24)	Byte 3 (Bits 23:16)	Byte 2 (Bits 15:8)	Byte 1 (Bits 7:0)
Set				717h
Get	F1700h			

Field Name	Bits	R/W	Default	Reset
Rsvd	31:3	R	00000000h	N/A (Hard-coded)
	Reserved.			
Control2	2	RW	0h	POR - DAFG - ULR
	Direction control for GPIO2: 0 = GPIO is configured as input; 1 = GPIO is configured as output			
Control1	1	RW	0h	POR - DAFG - ULR
	Direction control for GPIO1: 0 = GPIO is configured as input; 1 = GPIO is configured as output			
Control0	0	RW	0h	POR - DAFG - ULR
	Direction control for GPIO0: 0 = GPIO is configured as input; 1 = GPIO is configured as output			

**7.4.14. AFG (NID = 01h): GPIOWakeEn**

Reg	Byte 4 (Bits 31:24)	Byte 3 (Bits 23:16)	Byte 2 (Bits 15:8)	Byte 1 (Bits 7:0)
Set				718h
Get	F1800h			

Field Name	Bits	R/W	Default	Reset
Rsvd	31:3	R	00000000h	N/A (Hard-coded)
	Reserved.			
W2	2	RW	0h	POR - DAFG - ULR
	Wake enable for GPIO2: 0 = wake-up event is disabled; 1 = When HD Audio link is powered down (RST# is asserted), a wake-up event will trigger a Status Change Request event on the link.			

Field Name	Bits	R/W	Default	Reset
W1	1	RW	0h	POR - DAFG - ULR
	Wake enable for GPIO1: 0 = wake-up event is disabled; 1 = When HD Audio link is powered down (RST# is asserted), a wake-up event will trigger a Status Change Request event on the link.			
W0	0	RW	0h	POR - DAFG - ULR
	Wake enable for GPIO0: 0 = wake-up event is disabled; 1 = When HD Audio link is powered down (RST# is asserted), a wake-up event will trigger a Status Change Request event on the link.			

#### 7.4.15. AFG (NID = 01h): GPIOUnsol

Reg	Byte 4 (Bits 31:24)	Byte 3 (Bits 23:16)	Byte 2 (Bits 15:8)	Byte 1 (Bits 7:0)
Set				719h
Get	F1900h			

Field Name	Bits	R/W	Default	Reset
Rsvd	31:3	R	00000000h	N/A (Hard-coded)
	Reserved.			
EnMask2	2	RW	0h	POR - DAFG - ULR
	Unsolicited enable mask for GPIO2. If set, and the Unsolicited Response control for this widget has been enabled, an unsolicited response will be sent when GPIO2 is configured as input and changes state.			
EnMask1	1	RW	0h	POR - DAFG - ULR
	Unsolicited enable mask for GPIO1. If set, and the Unsolicited Response control for this widget has been enabled, an unsolicited response will be sent when GPIO1 is configured as input and changes state.			
EnMask0	0	RW	0h	POR - DAFG - ULR
	Unsolicited enable mask for GPIO0. If set, and the Unsolicited Response control for this widget has been enabled, an unsolicited response will be sent when GPIO0 is configured as input and changes state.			

#### 7.4.16. AFG (NID = 01h): GPIOSticky

Reg	Byte 4 (Bits 31:24)	Byte 3 (Bits 23:16)	Byte 2 (Bits 15:8)	Byte 1 (Bits 7:0)
Set				71Ah

**7.4.16. AFG (NID = 01h): GPIOSticky**

Reg	Byte 4 (Bits 31:24)	Byte 3 (Bits 23:16)	Byte 2 (Bits 15:8)	Byte 1 (Bits 7:0)
Get	F1A00h			

Field Name	Bits	R/W	Default	Reset
Rsvd	31:3	R	00000000h	N/A (Hard-coded)
	Reserved.			
Mask2	2	RW	0h	POR - DAFG - ULR
	GPIO2 input type (when configured as input): 0 = Non-Sticky (level-sensitive); 1 = Sticky (edge-sensitive).			
Mask1	1	RW	0h	POR - DAFG - ULR
	GPIO1 input type (when configured as input): 0 = Non-Sticky (level-sensitive); 1 = Sticky (edge-sensitive).			
Mask0	0	RW	0h	POR - DAFG - ULR
	GPIO0 input type (when configured as input): 0 = Non-Sticky (level-sensitive); 1 = Sticky (edge-sensitive).			

**7.4.17. AFG (NID = 01h): SubID**

Reg	Byte 4 (Bits 31:24)	Byte 3 (Bits 23:16)	Byte 2 (Bits 15:8)	Byte 1 (Bits 7:0)
Set	723h	722h	721h	720h
Get	F2300h / F2200h / F2100h / F2000h			

Field Name	Bits	R/W	Default	Reset
Subsys3	31:24	RW	00h	POR
	Subsystem ID (byte 3)			
Subsys2	23:16	RW	00h	POR
	Subsystem ID (byte 2)			
Subsys1	15:8	RW	01h	POR
	Subsystem ID (byte 1)			
Assembly	7:0	RW	00h	POR
	Assembly ID (Not applicable to codec vendors).			

**7.4.18. AFG (NID = 01h): GPIOIrty**

Reg	Byte 4 (Bits 31:24)	Byte 3 (Bits 23:16)	Byte 2 (Bits 15:8)	Byte 1 (Bits 7:0)
Set				770h
Get	F7000h			

Field Name	Bits	R/W	Default	Reset
Rsvd	31:3	R	00000000h	N/A (Hard-coded)
	Reserved.			
GP2	2	RW	1h	POR - DAFG - ULR
	GPIO2 Polarity: If configured as output or non-sticky input: 0 = inverting 1 = non-inverting  If configured as sticky input: 0 = falling edges will be detected 1 = rising edges will be detected			
GP1	1	RW	1h	POR - DAFG - ULR
	GPIO1 Polarity: If configured as output or non-sticky input: 0 = inverting 1 = non-inverting  If configured as sticky input: 0 = falling edges will be detected 1 = rising edges will be detected			
GP0	0	RW	1h	POR - DAFG - ULR
	GPIO0 Polarity: If configured as output or non-sticky input: 0 = inverting 1 = non-inverting  If configured as sticky input: 0 = falling edges will be detected 1 = rising edges will be detected			

**7.4.19. AFG (NID = 01h): GPIODrive**

Reg	Byte 4 (Bits 31:24)	Byte 3 (Bits 23:16)	Byte 2 (Bits 15:8)	Byte 1 (Bits 7:0)
Set				771h
Get	F7100h			

Field Name	Bits	R/W	Default	Reset
Rsvd	31:3	R	00000000h	N/A (Hard-coded)
	Reserved.			
OD2	2	RW	0h	POR - DAFG - ULR
	GPIO2 Drive Mode: 0 = push-pull (drive 0 and 1); 1 = open drain (drive 0, float for 1).			
OD1	1	RW	0h	POR - DAFG - ULR
	GPIO1 Drive Mode: 0 = push-pull (drive 0 and 1); 1 = open drain (drive 0, float for 1).			
OD0	0	RW	0h	POR - DAFG - ULR
	GPIO0 Drive Mode: 0 = push-pull (drive 0 and 1); 1 = open-drain (drive 0, float for 1).			

#### 7.4.20. AFG (NID = 01h): DMic

Reg	Byte 4 (Bits 31:24)	Byte 3 (Bits 23:16)	Byte 2 (Bits 15:8)	Byte 1 (Bits 7:0)
Set				778h
Get	F7800h			

Field Name	Bits	R/W	Default	Reset
Rsvd	31:6	R	0000000h	N/A (Hard-coded)
	Reserved.			
Mono1	5	RW	0h	POR
	DMic1 mono select: 0 = stereo operation, 1 = mono operation (left channel duplicated to the right channel).			
Mono0	4	RW	0h	POR
	DMic0 mono select: 0 = stereo operation, 1 = mono operation (left channel duplicated to the right channel).			
PhAdj	3:2	RW	0h	POR
	Selects what phase of the DMic clock the data should be latched: 0h = left data rising edge/right data falling edge 1h = left data center of high/right data center of low 2h = left data falling edge/right data rising edge 3h = left data center of low/right data center of high			

Field Name	Bits	R/W	Default	Reset
Rate	1:0	RW	2h	POR
Selects the DMic clock rate: 0h = 4.704MHz 1h = 3.528MHz 2h = 2.352MHz 3h = 1.176MHz.				

#### 7.4.21. AFG (NID = 01h): DACMode

Reg	Byte 4 (Bits 31:24)	Byte 3 (Bits 23:16)	Byte 2 (Bits 15:8)	Byte 1 (Bits 7:0)
Set				780h
Get	F8000h			

Field Name	Bits	R/W	Default	Reset
Rsvd	31:8	R	000000h	N/A (Hard-coded)
Reserved.				
SDMSettleDisable	7	RW	0h	POR
SDM wait-to-settle disable: 1 = at mute, the SDM switches to the mute pattern immediately 0 = at mute, the SDM switches to the mute pattern after settling (can take up to ~45ms)				
SDMCoeffSel	6	RW	0h	POR
DAC SDM coefficient select (stages 1, 2, 3): 1 = 1/16, 1/2, 1/4 0 = 1/16, 1/4, 1/2				
SDMLFHalf	5	RW	0h	POR
DAC SDM local feedback coefficient select: 1 = 1/4096, 0 = 1/2048.				
SDMLFDisable	4	RW	0h	POR
DAC SDM local feedback disable: 1 = local feedback disabled, 0 = local feedback enabled.				
InvertValid	3	RW	0h	POR
DAC Valid Invert: 1 = 7.056MHz valid strobe is inverted, 0 = 7.056MHz valid strobe is not inverted.				

# 92HD81

## SINGLE CHIP PC AUDIO SYSTEM, CODEC+SPEAKER AMPLIFIER+CAPLESS HP+LDO

Field Name	Bits	R/W	Default	Reset
InvertData	2	RW	0h	POR
	DAC Data Invert: 1 = 1-bit outputs are inverted, 0 = 1-bit outputs are not inverted.			
Atten6dBDisable	1	RW	0h	POR
	Disable built-in -6dB digital attenuation: 1 = -6dB disabled, 0 = -6dB enabled.			
Fade	0	RW	1h	POR
	DAC Gain Fade Enable: 1 = gain will be slowly faded from old value to new value (~10ms) 0 = gain will jump immediately to new value.			

### 7.4.22. AFG (NID = 01h): ADCMode

Reg	Byte 4 (Bits 31:24)	Byte 3 (Bits 23:16)	Byte 2 (Bits 15:8)	Byte 1 (Bits 7:0)
Set				784h
Get	F8400h			

Field Name	Bits	R/W	Default	Reset
Rsvd2	31:4	R	0000000h	N/A (Hard-coded)
	Reserved.			
InvertValid	3	RW	0h	POR
	ADC Valid Invert: 1 = 14.112MHz valid strobe is inverted, 0 = 14.112MHz valid strobe is not inverted.			
InvertData	2	RW	0h	POR
	ADC Data Invert: 1 = 1-bit inputs are inverted, 0 = 1-bit inputs are not inverted.			
Rsvd1	1:0	R	0h	N/A (Hard-coded)
	Reserved.			

### 7.4.23. AFG (NID = 01h): EAPD

Reg	Byte 4 (Bits 31:24)	Byte 3 (Bits 23:16)	Byte 2 (Bits 15:8)	Byte 1 (Bits 7:0)
Set				788h
Get	F8800h			

# 92HD81

## SINGLE CHIP PC AUDIO SYSTEM, CODEC+SPEAKER AMPLIFIER+CAPLESS HP+LDO

Field Name	Bits	R/W	Default	Reset
Rsvd4	31:15	R	00000h	N/A (Hard-coded)
	Reserved.			
HPBSDInv	14	RW	0h	POR
	HP Amp Shutdown Invert: 0 = Amp will power down (or mute) when EAPD pin is low 1 = Amp will power down (or mute) when EAPD pin is high			
HPBSDMode	13	RW	0h (YC/YD) 1h (UA/TA/RA)	POR
	HP Amp Shutdown Mode: 0 = Amp will mute when disabled 1 = Amp will enter a low power state when disabled			
HPBSD	12	RW	0h	POR
	HP Amp Shutdown Control Select: 0 = Amp controlled by EAPD pin only 1 = Amp controlled by power state only			
Rsvd3	11	R	0h	N/A (Hard-coded)
	Reserved.			
HPASDInv	10	RW	0h	POR
	HP Amp Shutdown Invert: 0 = Amp will power down (or mute) when EAPD pin is low 1 = Amp will power down (or mute) when EAPD pin is high			
HPASDMode	9	RW	0h (YC/YD) 1h (UA/TA/RA)	POR
	HP Amp Shutdown Mode: 0 = Amp will mute when disabled 1 = Amp will enter a low power state when disabled			
HPASD	8	RW	0h	POR
	HP Amp Shutdown Control Select: 0 = Amp controlled by EAPD pin only 1 = Amp controlled by power state only			
Rsvd2	7	R	0h	N/A (Hard-coded)
	Reserved.			



# 92HD81

## SINGLE CHIP PC AUDIO SYSTEM, CODEC+SPEAKER AMPLIFIER+CAPLESS HP+LDO

Field Name	Bits	R/W	Default	Reset
BTLSDInv	6	RW	0h	POR
	BTL Amp Shutdown Invert: 0 = Amp will power down (or mute) when EAPD pin is low 1 = Amp will power down (or mute) when EAPD pin is high			
BTLSDMode	5	RW	0h (YC/YD) 1h (UA/TA/RA)	POR
	BTL Amp Shutdown Mode: 0 = Amp will mute when disabled 1 = Amp will enter a low power state when disabled			
BTLSD	4	RW	0h	POR
	BTL Amp Shutdown Control Select: 0 = Amp controlled by EAPD pin only 1 = Amp controlled by power state only			
Rsvd1	3:2	R	0h	N/A (Hard-coded)
	Reserved.			
PinMode	1:0	RW	0h	POR
	EAPD Pin Mode: 00b = Open Drain I/O (Value at pin is wired-AND of EAPD bit and external signal) 01b = CMOS Output (Value of EAPD bit is forced at pin) 1xb = CMOS Input (External signal controls internal amps, EAPD bit ignored)			

### 7.4.24. AFG (NID = 01h): PortUse

Reg	Byte 4 (Bits 31:24)	Byte 3 (Bits 23:16)	Byte 2 (Bits 15:8)	Byte 1 (Bits 7:0)
Set				7C0h
Get	FC000h			

Field Name	Bits	R/W	Default	Reset
Rsvd	31:7	R	0000000h	N/A (Hard-coded)
	Reserved.			
Mono	6	RW	0h (YC/YD) 1h (UA/TA/RA)	POR
	1=power down port if not input or output enabled, 0=do not force power down based on input or output enable			

Field Name	Bits	R/W	Default	Reset
PortF	5	RW	0h (YC/YD) 1h (UA/TA/RA)	POR
PortE	4	RW	0h (YC/YD) 1h (UA/TA/RA)	POR
PortD	3	RW	0h (YC/YD) 1h (UA/TA/RA)	POR
PortC	2	RW	0h (YC/YD) 1h (UA/TA/RA)	POR
PortB	1	RW	0h (YC/YD) 1h (UA/TA/RA)	POR
PortA	0	RW	0h (YC/YD) 1h (UA/TA/RA)	POR

**7.4.25. AFG (NID = 01h): VSPwrState**

Reg	Byte 4 (Bits 31:24)	Byte 3 (Bits 23:16)	Byte 2 (Bits 15:8)	Byte 1 (Bits 7:0)
Set				7D8h
Get	FD800h			

Field Name	Bits	R/W	Default	Reset
Rsvd	31:2	R	00000000h	N/A (Hard-coded)

Field Name	Bits	R/W	Default	Reset
D5	1	RW	0h	POR - ELR
	Vendor specific D5 power state, only entered once the part is already in D3cold (this bit must be set before the command to enter D3cold). If set, this bit overrides the D4 bit (bit 0). Includes the power savings of D4, but additionally powers down GPIO pins, the VAG amp, and the HP amps. Exits this power state via POR or rising edge of Link Reset.			
D4	0	RW	0h	POR - ELR
	Vendor specific D4 power state, only entered once the part is already in D3cold (this bit must be set before the command to enter D3cold). If the D5 bit (bit 1) is set, this bit is overridden. Includes the power savings of D3cold, but additionally powers down the HDA interface (no responses). Exit this power state via POR or rising edge of Link Reset.			

#### 7.4.26. AFG (NID = 01h): AnaPort

Reg	Byte 4 (Bits 31:24)	Byte 3 (Bits 23:16)	Byte 2 (Bits 15:8)	Byte 1 (Bits 7:0)
Set			7EDh	7ECh
Get	FEC00h			

Field Name	Bits	R/W	Default	Reset
Rsvd2	31:7	R	0000000h	N/A (Hard-coded)
	Reserved.			
MonoPw	6	RW	0h	POR
	Power down Mono Output.			
FPw	5	RW	0h	POR
	Power down Port F.			
EPw	4	RW	0h	POR
	Power down Port E.			
DPw	3	RW	0h	POR
	Power down Port D.			
CPw	2	RW	0h	POR
	Power down Port C.			

Field Name	Bits	R/W	Default	Reset
BPwd	1	RW	0h	POR
	Power down Port B.			
APwd	0	RW	0h	POR
	Power down Port A.			

#### 7.4.27. AFG (NID = 01h): AnaBeep

Reg	Byte 4 (Bits 31:24)	Byte 3 (Bits 23:16)	Byte 2 (Bits 15:8)	Byte 1 (Bits 7:0)
Set				7EEh
Get	FEE0h			

Field Name	Bits	R/W	Default	Reset
Rsvd	31:3	R	0000000h	N/A (Hard-coded)
	Reserved.			
Gain	2:1	RW	3h	POR
	Analog PC Beep Gain: 0h = -24dB, 1h = -18dB, 2h = -12dB, 3h = -6dB.			
Enable	0	RW	0h	POR
	Analog PC Beep Enable: 1 = Analog PC beep enabled, 0 = Analog PC beep disabled.			

#### 7.4.28. AFG (NID = 01h): AnaBTL YC and YD Revisions

Reg	Byte 4 (Bits 31:24)	Byte 3 (Bits 23:16)	Byte 2 (Bits 15:8)	Byte 1 (Bits 7:0)
Set		7F6h	7F5h	7F4h
Get	FF40h			

Field Name	Bits	R/W	Default	Reset
Rsvd4	31:30	R	0h	N/A (Hard-coded)
	Reserved.			

**92HD81**

**SINGLE CHIP PC AUDIO SYSTEM, CODEC+SPEAKER AMPLIFIER+CAPLESS HP+LDO**

Field Name	Bits	R/W	Default	Reset
TSOverHeat	29	R	0h	POR
	Temperature sensing overheat indicator.			
TSAIgVol	28:24	R	17h	POR
	Temperature sensing volume for the BTL amplifier: 00000b..11111b = Range specificity for MaxVol field.			
Rsvd3	23:22	R	0h	N/A (Hard-coded)
	Reserved.			
TSOverrideReset	21	RW	0h	POR
	Override reset for the BTL amplifier temperature sensing circuit: set to 1 to recalculate, set back to 0 to latch the value.			
TSOverrideVol	20:16	RW	17h	POR
	Override volume for the BTL amplifier: 00000b..11111b = Range specified for MaxVol field.			
TSOverrideSel	15	RW	0h	POR
	Override select for the BTL amplifier volume.			
Rsvd2	14:12	R	0h	N/A (Hard-coded)
	Reserved.			
TSWait	11:8	RW	6h (YA rev) 0h	POR
	Temperature sensing wait time between volume increments/decrements: 0h..Fh = 0..1.28s in 85.3ms steps.			
MonoSel	7	RW	0h	POR
	Mono select for the BTL amplifier: 1= mono, 0 = stereo.			
Rsvd1	6:5	R	0h	N/A (Hard-coded)
	Reserved.			

Field Name	Bits	R/W	Default	Reset
MaxVol	4:0	RW	17h	POR
Gain setting for the BTL amplifier (temperature sensing logic will decrement from here): 00000 = -26.25dB: 00001 = -19.80dB 00010 = -15.80dB 00011 = -12.85dB 00100 = -10.40dB 00101 = -8.27dB 00110 = -6.35dB 00111 = -4.60dB 01000 = -2.90dB 01001 = -1.25dB 01010 = 0.35dB 01011 = 1.98dB 01100 = 3.63dB 01101 = 5.35dB 01110 = 7.19dB 01111 = 9.18dB 10000 = 9.95dB 10001 = 10.75dB 10010 = 11.58dB 10011 = 12.48dB 10100 = 13.43dB 10101 = 14.46dB 10110 = 15.57dB 10111 = 16.79dB 11000-11111 = Not valid				

**7.4.29. AFG (NID = 01h): AnaBTL UA,TA, RA Revisions**

Reg	Byte 4 (Bits 31:24)	Byte 3 (Bits 23:16)	Byte 2 (Bits 15:8)	Byte 1 (Bits 7:0)
Set		7F6h	7F5h	7F4h
Get	FF400h			

Field Name	Bits	R/W	Default	Reset
Rsvd3	31	R	0h	N/A (Hard-coded)
Reserved.				
TSTripHighStatus	30	R	0h	POR
Temp sense high trip point status				

# 92HD81

## SINGLE CHIP PC AUDIO SYSTEM, CODEC+SPEAKER AMPLIFIER+CAPLESS HP+LDO

Field Name	Bits	R/W	Default	Reset
TSripLowStatus	29	R	0h	POR
	Temp sense low trip point status			
TSVolStatus	28:24	R	00h	POR
	Temp sense volume status for the BTL amplifier: 00000b..11111b = Range specificity for MaxVol field.			
TSMuteStatus	23	R	0h	POR
	Temp sense forced mute status for the BTL amplifier.			
TSPwdStatus	22	R	0h	POR
	Temp sense forced powerdown status for the BTL amplifier.			
Rsvd2	21	R	0h	N/A (Hard-coded)
	Reserved.			
TSOverrideReset	20	RW	0h	POR
	Override reset for the BTL amplifier temperature sensing circuit: set to 1 to recalculate, set back to 0 to latch the value.			
TSOverrideSel	19	RW	0h	POR
	Override select for the BTL amplifier volume. Use MaxVol[4:0] and TSOverrideReset directly to drive analog			
TSTestMode	18	RW	0h	POR
	Temp sense test mode select, 0=normal operation, 1=sensor will trip at ambient temperature.			
TSForcePwd	17	RW	0h (UA) 1h (TA)	POR
	Temp sense force powerdown select 0=BTL will not be muted and powered down even if it is still overheating when the volume is 0h 1=BTL will be muted and powered down even if it is still overheating when the volume is 0h			
TSInstantCutMode	16	RW	0h	POR
	Temp sense instant cut mode 0=Two trip points used to smoothly adjust the volume 1=One single trip point used to set volume to wither 0 or max value (TI mode)			

# 92HD81

## SINGLE CHIP PC AUDIO SYSTEM, CODEC+SPEAKER AMPLIFIER+CAPLESS HP+LDO

Field Name	Bits	R/W	Default	Reset
TSWait	15:12	RW	3h	POR
	Temperature sensing wait time between volume increments 0h = 2ms (polling at 2ms) 1h = 4ms (polling at 4ms) 2h = 8ms (polling at 8ms) 3h = 16ms (polling at 16ms) 4h = 32ms (polling at 16ms) 5h = 64ms (polling at 16ms) 6h = 128ms (polling at 16ms) 7h = 256ms (polling at 16ms) 8h = 512ms (polling at 16ms) 9h = 1.024s (polling at 16ms) Ah = 2.048s (polling at 16ms) Bh = 4.096s (polling at 16ms) Ch = 8.192s (polling at 16ms) Dh = 16.384s (polling at 16ms) Eh = 32.768s (polling at 16ms) Fh = 65.536s (polling at 16ms).			
TSTripSplit	11:10	RW	0h	POR
	Temp sense split setting, determines how many degrees above the low point the high point is set: 0h = 15 Degrees C 1h = 30 Degrees C 2h = 45 Degrees C 3h = 60 Degrees C.			
TSTripShift	9:8	RW	02h	POR
	Temp sense shift setting, determines where the low point is set: 0h = 110 Degrees C 1h = 125 Degrees C 2h = 140 Degrees C 3h = 155 Degrees C			
Rsvd1	7:6	R	0h	NA
	Reserved			
MonoSel	5	RW	0h'	POR
	Mono select for the BTL amplifier, 1=mono, 0=stereo			



Field Name	Bits	R/W	Default	Reset
MaxVol	4:0	RW	0Fh	POR
Gain setting for the BTL amplifier (temperature sensing logic will decrement from here): 00000 = -26.25dB: 00001 = -19.80dB 00010 = -15.80dB 00011 = -12.85dB 00100 = -10.40dB 00101 = -8.27dB 00110 = -6.35dB 00111 = -4.60dB 01000 = -2.90dB 01001 = -1.25dB 01010 = 0.35dB 01011 = 1.98dB 01100 = 3.63dB 01101 = 5.35dB 01110 = 7.19dB 01111 = 9.18dB 10000 = 9.95dB 10001 = 10.75dB 10010 = 11.58dB 10011 = 12.48dB 10100 = 13.43dB 10101 = 14.46dB 10110 = 15.57dB 10111 = 16.79dB 11000-11111 = Not valid				

**7.4.30. AFG (NID = 01h): AnaCapless**

Reg	Byte 4 (Bits 31:24)	Byte 3 (Bits 23:16)	Byte 2 (Bits 15:8)	Byte 1 (Bits 7:0)
Set		7FAh	7F9h	7F8h
Get	FF800h			

Field Name	Bits	R/W	Default	Reset
Rsvd	31:26	R	00h	N/A (Hard-coded)
Reserved.				
VRegSCDet	25	R	0h	POR
Capless regulator short circuit detect indicator.				

**92HD81****SINGLE CHIP PC AUDIO SYSTEM, CODEC+SPEAKER AMPLIFIER+CAPLESS HP+LDO**

Field Name	Bits	R/W	Default	Reset
ChargePumpSCDet	24	R	0h	POR
	Capless charge pump short circuit detect indicator.			
VRegSel	23:20	RW	4h (YC/YD) 3h (UA/TA/RA)	POR
	Capless regulator output voltage multiply ratio.			
VRegSCRstB	19	RW	0h	POR
	Capless regulator short circuit detect reset: 0 = short circuit detect disabled, 1 = short circuit detect enabled.			
VRegGndShort	18	RW	0h	POR
	Ground the capless regulator output.			
VRegPwd	17	RW	0h	POR
	Capless regulator powerdown.			
ChargePumpSCRstB	16	RW	0h	POR
	Capless charge pump short circuit detect reset: 0 = short circuit detect disabled, 1 = short circuit detect enabled.			
ChargePumpHiZ	15	RW	0h	POR
	Hi-Z the capless charge pump outputs.			
ChargePumpPwd	14	RW	0h	POR
	Capless charge pump powerdown.			
ChargePumpSplyDetOverride	13	RW	1h (YA rev) 0h	POR
	Capless charge pump supply detect override.			
ChargePumpFreqBypass	12	RW	1h 0h (YB rev)	POR
	Capless charge pump frequency reg bypass.			

# 92HD81

## SINGLE CHIP PC AUDIO SYSTEM, CODEC+SPEAKER AMPLIFIER+CAPLESS HP+LDO

Field Name	Bits	R/W	Default	Reset
ChargePumpClkRate	11:8	RW	8h	POR
Capless charge pump clock rate: 0000b = 800.0kHz (24MHz/30) 0001b = 750.0kHz (24MHz/32) 0010b = 706.9kHz (24MHz/34) 0011b = 666.7kHz (24MHz/36) 0100b = 631.6kHz (24MHz/38) 0101b = 600.0kHz (24MHz/40) 0110b = 571.4kHz (24MHz/42) 0111b = 545.5kHz (24MHz/44) 1000b = 800.0kHz (24MHz/30) 1001b = 857.1kHz (24MHz/28) 1010b = 923.1kHz (24MHz/26) 1011b = 1.000MHz (24MHz/24) 1100b = 1.091MHz (24MHz/22) 1101b = 1.200MHz (24MHz/20) 1110b = 1.333MHz (24MHz/18) 1111b = 1.500MHz (24MHz/16)				
ChargePumpClkDiv	7:5	RW	4h	POR
Capless charge pump analog clock divider: 001b = No divide 010b = Divide by 2, 50% duty cycle 100b = Divide by 4, 50% duty cycle 110b = Divide by 2, 75% duty cycle 011b = Divide by 4, 75% duty cycle 111b = Divide by 4, 87.5% duty cycle Other values undefined				
ChargePumpClkSel	4	RW	0h	POR
Capless charge pump clock select: 0 = ring oscillator, 1 = charge pump clock defined by AFGCaplessChargePumpClkRate[3:0] field below.				
PadGnd	3	RW	0h	POR
Ground the output pad of the capless amplifiers.				
InputGnd	2	RW	0h	POR
Ground the input to the capless output amplifiers.				
Reserved	1	R	0h	POR
Revisions YC & prior was capless headphone amplifier gain. This bit is no longer needed..				
AntiPopBypass	0	RW	0h	POR
Revision YC & prior was capless headphone gain. This bit has been repurposed for Anti-Pop bypass..				

**7.4.31. AFG (NID = 01h): Reset**

Reg	Byte 4 (Bits 31:24)	Byte 3 (Bits 23:16)	Byte 2 (Bits 15:8)	Byte 1 (Bits 7:0)
Set				7FFh
Get	FFF00h			

Field Name	Bits	R/W	Default	Reset
Rsvd1	31:8	R	000000h	N/A (Hard-coded)
	Reserved.			
Execute	7:0	W	00h	N/A (Hard-coded)
	Function Reset. Function Group reset is executed when the Set verb 7FF is written with 8-bit payload of 00h. The codec should issue a response to acknowledge receipt of the verb, and then reset the affected Function Group and all associated widgets to their power-on reset values. Some controls such as Configuration Default controls should not be reset. Overlaps Response.			

**7.4.32. AFG (NID = 01h): AuxAudio**

Reg	Byte 4 (Bits 31:24)	Byte 3 (Bits 23:16)	Byte 2 (Bits 15:8)	Byte 1 (Bits 7:0)
Set				774h
Get	F7400h			

Field Name	Bits	R/W	Default	Reset
Rsvd	31:2	R	00000000h	N/A (Hard-coded)
	Reserved.			
MixerPwD	1	RW	0h	POR
	Aux Audio Moder mixer powerdown: 0 = Mixer enabled during Aux Audio Mode, 1 = Mixer forced powered down during Aux Audio Mode.			
Enable	0	RW	1h	POR
	Aux Audio Mode select: 0 = Aux Audio disabled, 1 = Aux Audio enabled during HDA Link Reset.			

## 7.5. PortA (NID = 0Ah): WCap

Reg	Byte 4 (Bits 31:24)	Byte 3 (Bits 23:16)	Byte 2 (Bits 15:8)	Byte 1 (Bits 7:0)
Set				
Get	F0009h			

Field Name	Bits	R/W	Default	Reset
Rsvd2	31:24	R	00h	N/A (Hard-coded)
	Reserved.			
Type	23:20	R	4h	N/A (Hard-coded)
	Widget type: 0h = Out Converter 1h = In Converter 2h = Summing (Mixer) 3h = Selector (Mux) 4h = Pin Complex 5h = Power 6h = Volume Knob 7h = Beep Generator 8h-Eh = Reserved Fh = Vendor Defined			
Delay	19:16	R	0h	N/A (Hard-coded)
	Number of sample delays through widget.			
Rsvd1	15:12	R	0h	N/A (Hard-coded)
	Reserved.			
SwapCap	11	R	0h	N/A (Hard-coded)
	Left/right swap support: 1 = yes, 0 = no.			
PwrCntrl	10	R	1h	N/A (Hard-coded)
	Power state support: 1 = yes, 0 = no.			
Dig	9	R	0h	N/A (Hard-coded)
	Digital stream support: 1 = yes (digital), 0 = no (analog).			
ConnList	8	R	1h	N/A (Hard-coded)
	Connection list present: 1 = yes, 0 = no.			
UnSolCap	7	R	1h	N/A (Hard-coded)
	Unsolicited response support: 1 = yes, 0 = no.			

# 92HD81

## SINGLE CHIP PC AUDIO SYSTEM, CODEC+SPEAKER AMPLIFIER+CAPLESS HP+LDO

Field Name	Bits	R/W	Default	Reset
ProcWidget	6	R	0h	N/A (Hard-coded)
	Processing state support: 1 = yes, 0 = no.			
Stripe	5	R	0h	N/A (Hard-coded)
	Striping support: 1 = yes, 0 = no.			
FormatOvr	4	R	0h	N/A (Hard-coded)
	Stream format override: 1 = yes, 0 = no.			
AmpParOvr	3	R	0h	N/A (Hard-coded)
	Amplifier capabilities override: 1 = yes, no.			
OutAmpPrsnt	2	R	0h	N/A (Hard-coded)
	Output amp present: 1 = yes, 0 = no.			
InAmpPrsnt	1	R	1h	N/A (Hard-coded)
	Input amp present: 1 = yes, 0 = no.			
Stereo	0	R	1h	N/A (Hard-coded)
	Stereo stream support: 1 = yes (stereo), 0 = no (mono).			

### 7.5.1. PortA (NID = 0Ah): PinCap

Reg	Byte 4 (Bits 31:24)	Byte 3 (Bits 23:16)	Byte 2 (Bits 15:8)	Byte 1 (Bits 7:0)
Set				
Get	F000Ch			

Field Name	Bits	R/W	Default	Reset
Rsvd2	31:17	R	0000h	N/A (Hard-coded)
	Reserved.			
EapdCap	16	R	1h	N/A (Hard-coded)
	EAPD support: 1 = yes, 0 = no.			

# 92HD81

## SINGLE CHIP PC AUDIO SYSTEM, CODEC+SPEAKER AMPLIFIER+CAPLESS HP+LDO

Field Name	Bits	R/W	Default	Reset
VrefCntrl	15:8	R	17h	N/A (Hard-coded)
	Vref support: bit 7 = Reserved bit 6 = Reserved bit 5 = 100% support (1 = yes, 0 = no) bit 4 = 80% support (1 = yes, 0 = no) bit 3 = Reserved bit 2 = GND support (1 = yes, 0 = no) bit 1 = 50% support (1 = yes, 0 = no) bit 0 = Hi-Z support (1 = yes, 0 = no)			
Rsvd1	7	R	0h	N/A (Hard-coded)
	Reserved.			
BalancedIO	6	R	0h	N/A (Hard-coded)
	Balanced I/O support: 1 = yes, 0 = no.			
InCap	5	R	1h	N/A (Hard-coded)
	Input support: 1 = yes, 0 = no.			
OutCap	4	R	1h	N/A (Hard-coded)
	Output support: 1 = yes, 0 = no.			
HdphDrvCap	3	R	1h	N/A (Hard-coded)
	Headphone amp present: 1 = yes, 0 = no.			
PresDtctCap	2	R	1h	N/A (Hard-coded)
	Presence detection support: 1 = yes, 0 = no.			
TrigRqd	1	R	0h	N/A (Hard-coded)
	Trigger required for impedance sense: 1 = yes, 0 = no.			
ImpSenseCap	0	R	0h	N/A (Hard-coded)
	Impedance sense support: 1 = yes, 0 = no.			

### 7.5.2. PortA (NID = 0Ah): ConLst

Reg	Byte 4 (Bits 31:24)	Byte 3 (Bits 23:16)	Byte 2 (Bits 15:8)	Byte 1 (Bits 7:0)
Set				
Get	F000Eh			

Field Name	Bits	R/W	Default	Reset
Rsvd	31:8	R	000000h	N/A (Hard-coded)
	Reserved.			
LForm	7	R	0h	N/A (Hard-coded)
	Connection list format: 1 = long-form (15-bit) NID entries, 0 = short-form (7-bit) NID entries.			
ConL	6:0	R	03h	N/A (Hard-coded)
	Number of NID entries in connection list.			

### 7.5.3. PortA (NID = 0Ah): ConLstEntry0

Reg	Byte 4 (Bits 31:24)	Byte 3 (Bits 23:16)	Byte 2 (Bits 15:8)	Byte 1 (Bits 7:0)
Set				
Get	F0200h			

Field Name	Bits	R/W	Default	Reset
ConL3	31:24	R	00h	N/A (Hard-coded)
	DAC2 Converter widget (0x22)			
ConL2	23:16	R	1Ch	N/A (Hard-coded)
	MixerOutVol Selector widget (0x1C)			
ConL1	15:8	R	14h	N/A (Hard-coded)
	DAC1 Converter widget (0x14)			
ConL0	7:0	R	13h	N/A (Hard-coded)
	DAC0 Converter widget (0x13)			

### 7.5.4. PortA (NID = 0Ah): InAmpLeft

Reg	Byte 4 (Bits 31:24)	Byte 3 (Bits 23:16)	Byte 2 (Bits 15:8)	Byte 1 (Bits 7:0)
Set				360h
Get	B2000h			



Field Name	Bits	R/W	Default	Reset
Rsvd1	31:2	R	00000000h	N/A (Hard-coded)
	Reserved.			
Gain	1:0	RW	0h	POR - DAFG - ULR
	Amp gain step number (see InAmpCap parameter pertaining to this widget).			

#### 7.5.5. PortA (NID = 0Ah): InAmpRight

Reg	Byte 4 (Bits 31:24)	Byte 3 (Bits 23:16)	Byte 2 (Bits 15:8)	Byte 1 (Bits 7:0)
Set				350h
Get	B0000h			

Field Name	Bits	R/W	Default	Reset
Rsvd1	31:2	R	00000000h	N/A (Hard-coded)
	Reserved.			
Gain	1:0	RW	0h	POR - DAFG - ULR
	Amp gain step number (see InAmpCap parameter pertaining to this widget).			

#### 7.5.6. PortA (NID = 0Ah): ConSelectCtrl

Reg	Byte 4 (Bits 31:24)	Byte 3 (Bits 23:16)	Byte 2 (Bits 15:8)	Byte 1 (Bits 7:0)
Set				701h
Get	F0100h			

Field Name	Bits	R/W	Default	Reset
Rsvd	31:2	R	00000000h	N/A (Hard-coded)
	Reserved.			
Index	1:0	RW	0h	POR - DAFG - ULR
	Connection select control index.			

**7.5.7. PortA (NID = 0Ah): PwrState**

Reg	Byte 4 (Bits 31:24)	Byte 3 (Bits 23:16)	Byte 2 (Bits 15:8)	Byte 1 (Bits 7:0)
Set				705h
Get	F0500h			

Field Name	Bits	R/W	Default	Reset
Rsvd4	31:11	R	000000h	N/A (Hard-coded)
	Reserved.			
SettingsReset	10	R	1h	POR - DAFG - ULR
	Indicates if any persistent settings in this Widget have been reset. Cleared by PwrState 'Get', or a 'Set' to any Verb in this Widget.			
Rsvd3	9	R	0h	N/A (Hard-coded)
	Reserved.			
Error	8	R	0h	POR - DAFG - ULR
	Error indicator: 1 = cannot enter requested power state, 0 = no problem with requested power state.			
Rsvd2	7:6	R	0h	N/A (Hard-coded)
	Reserved.			
Act	5:4	R	3h	POR - DAFG - LR
	Actual power state of this widget.			
Rsvd1	3:2	R	0h	N/A (Hard-coded)
	Reserved.			
Set	1:0	RW	0h	POR - DAFG - LR
	Current power state setting for this widget.			

**7.5.8. PortA (NID = 0Ah): PinWCntrl**

Reg	Byte 4 (Bits 31:24)	Byte 3 (Bits 23:16)	Byte 2 (Bits 15:8)	Byte 1 (Bits 7:0)
Set				707h
Get	F0700h			

Field Name	Bits	R/W	Default	Reset
Rsvd2	31:8	R	000000h	N/A (Hard-coded)
	Reserved.			
HPhnEn	7	RW	0h	POR - DAFG - ULR
	Headphone amp enable: 1 = enabled, 0 = disabled.			
OutEn	6	RW	0h	POR - DAFG - ULR
	Output enable: 1 = enabled, 0 = disabled.			
InEn	5	RW	0h	POR - DAFG - ULR
	Input enable: 1 = enabled, 0 = disabled.			
Rsvd1	4:3	R	0h	N/A (Hard-coded)
	Reserved.			
VRefEn	2:0	RW	0h	POR - DAFG - ULR
	Vref selection (See VrefCntrl field of PinCap parameter for supported selections): 000b= HI-Z 001b= 50% 010b= GND 011b= Reserved 100b= 80% 101b= 100% 110b= Reserved 111b= Reserved			

**7.5.9. PortA (NID = 0Ah): UnsolResp**

Reg	Byte 4 (Bits 31:24)	Byte 3 (Bits 23:16)	Byte 2 (Bits 15:8)	Byte 1 (Bits 7:0)
Set				708h
Get	F0800h			

Field Name	Bits	R/W	Default	Reset
Rsvd2	31:8	R	000000h	N/A (Hard-coded)
	Reserved.			

Field Name	Bits	R/W	Default	Reset
En	7	RW	0h	POR - DAFG - ULR
	Unsolicited response enable (also enables Wake events for this Widget): 1 = enabled, 0 = disabled.			
Rsvd1	6	R	0h	N/A (Hard-coded)
	Reserved.			
Tag	5:0	RW	00h	POR - DAFG - ULR
	Software programmable field returned in top six bits (31:26) of every Unsolicited Response generated by this node.			

#### 7.5.10. PortA (NID = 0Ah): ChSense

Reg	Byte 4 (Bits 31:24)	Byte 3 (Bits 23:16)	Byte 2 (Bits 15:8)	Byte 1 (Bits 7:0)
Set				709h
Get	F0900h			

Field Name	Bits	R/W	Default	Reset
PresDtct	31	R	0h	POR
	Presence detection indicator: 1 = presence detected; 0 = presence not detected.			
Rsvd	30:0	R	00000000h	N/A (Hard-coded)
	Reserved.			

#### 7.5.11. PortA (NID = 0Ah): EAPDBTLLR

Reg	Byte 4 (Bits 31:24)	Byte 3 (Bits 23:16)	Byte 2 (Bits 15:8)	Byte 1 (Bits 7:0)
Set				70Ch
Get	F0C00h			

Field Name	Bits	R/W	Default	Reset
Rsvd2	31:2	R	00000000h	N/A (Hard-coded)
	Reserved.			

Field Name	Bits	R/W	Default	Reset
EAPD	1	RW	1h	POR - DAFG - ULR
	EAPD control: 1 = set EAPD pin to 1 (powered) up if this pin is powered up, 0 = set EAPD pin to 0.			
Rsvd1	0	R	0h	N/A (Hard-coded)
	Reserved.			

**7.5.12. PortA (NID = 0Ah): ConfigDefault**

Reg	Byte 4 (Bits 31:24)	Byte 3 (Bits 23:16)	Byte 2 (Bits 15:8)	Byte 1 (Bits 7:0)
Set	71Fh	71Eh	71Dh	71Ch
Get	F1F00h / F1E00h / F1D00h / F1C00h			

Field Name	Bits	R/W	Default	Reset
PortConnectivity	31:30	RW	0h	POR
	Port connectivity: 0h = Port complex is connected to a jack 1h = No physical connection for port 2h = Fixed function device is attached 3h = Both jack and internal device attached (info in all other fields refers to integrated device, any presence detection refers to jack)			
Location	29:24	RW	02h	POR
	Location  Bits [5..4]: 0h = External on primary chassis 1h = Internal 2h = Separate chassis 3h = Other  Bits [3..0]: 0h = N/A 1h = Rear 2h = Front 3h = Left 4h = Right 5h = Top 6h = Bottom 7h-9h = Special Ah-Fh = Reserved			

# 92HD81

## SINGLE CHIP PC AUDIO SYSTEM, CODEC+SPEAKER AMPLIFIER+CAPLESS HP+LDO

Field Name	Bits	R/W	Default	Reset
Device	23:20	RW	2h	POR
Default device: 0h = Line out 1h = Speaker 2h = HP out 3h = CD 4h = SPDIF Out 5h = Digital other out 6h = Modem line side 7h = Modem handset side 8h = Line in 9h = Aux Ah = Mic in Bh = Telephony Ch = SPDIF In Dh = Digital other in Eh = Reserved Fh = Other				
ConnectionType	19:16	RW	1h	POR
Connection type: 0h = Unknown 1h = 1/8" stereo/mono 2h = 1/4" stereo/mono 3h = ATAPI internal 4h = RCA 5h = Optical 6h = Other digital 7h = Other analog 8h = Multichannel analog (DIN) 9h = XLR/Professional Ah = RJ-11 (modem) Bh = Combination Ch-Eh = Reserved Fh = Other				

# 92HD81

## SINGLE CHIP PC AUDIO SYSTEM, CODEC+SPEAKER AMPLIFIER+CAPLESS HP+LDO

Field Name	Bits	R/W	Default	Reset
Color	15:12	RW	4h	POR
	Color: 0h = Unknown 1h = Black 2h = Grey 3h = Blue 4h = Green 5h = Red 6h = Orange 7h = Yellow 8h = Purple 9h = Pink Ah-Dh = Reserved Eh = White Fh = Other			
Misc	11:8	RW	0h	POR
	Miscellaneous: Bits [3..1] = Reserved Bit 0 = Jack detect override			
Association	7:4	RW	3h	POR
	Default association.			
Sequence	3:0	RW	Fh	POR
	Sequence.			

### 7.6. PortB (NID = 0Bh): WCap

Reg	Byte 4 (Bits 31:24)	Byte 3 (Bits 23:16)	Byte 2 (Bits 15:8)	Byte 1 (Bits 7:0)
Set				
Get	F0009h			

Field Name	Bits	R/W	Default	Reset
Rsvd2	31:24	R	00h	N/A (Hard-coded)
	Reserved.			

# 92HD81

## SINGLE CHIP PC AUDIO SYSTEM, CODEC+SPEAKER AMPLIFIER+CAPLESS HP+LDO

Field Name	Bits	R/W	Default	Reset
Type	23:20	R	4h	N/A (Hard-coded)
Widget type: 0h = Out Converter 1h = In Converter 2h = Summing (Mixer) 3h = Selector (Mux) 4h = Pin Complex 5h = Power 6h = Volume Knob 7h = Beep Generator 8h-Eh = Reserved Fh = Vendor Defined				
Delay	19:16	R	0h	N/A (Hard-coded)
Number of sample delays through widget.				
Rsvd1	15:12	R	0h	N/A (Hard-coded)
Reserved.				
SwapCap	11	R	0h	N/A (Hard-coded)
Left/right swap support: 1 = yes, 0 = no.				
PwrCntrl	10	R	1h	N/A (Hard-coded)
Power state support: 1 = yes, 0 = no.				
Dig	9	R	0h	N/A (Hard-coded)
Digital stream support: 1 = yes (digital), 0 = no (analog).				
ConnList	8	R	1h	N/A (Hard-coded)
Connection list present: 1 = yes, 0 = no.				
UnSolCap	7	R	1h	N/A (Hard-coded)
Unsolicited response support: 1 = yes, 0 = no.				
ProcWidget	6	R	0h	N/A (Hard-coded)
Processing state support: 1 = yes, 0 = no.				
Stripe	5	R	0h	N/A (Hard-coded)
Striping support: 1 = yes, 0 = no.				
FormatOvrd	4	R	0h	N/A (Hard-coded)
Stream format override: 1 = yes, 0 = no.				



Field Name	Bits	R/W	Default	Reset
AmpParOvrd	3	R	0h	N/A (Hard-coded)
Amplifier capabilities override: 1 = yes, no.				
OutAmpPrsnt	2	R	0h	N/A (Hard-coded)
Output amp present: 1 = yes, 0 = no.				
InAmpPrsnt	1	R	0h	N/A (Hard-coded)
Input amp present: 1 = yes, 0 = no.				
Stereo	0	R	1h	N/A (Hard-coded)
Stereo stream support: 1 = yes (stereo), 0 = no (mono).				

### 7.6.1. PortB (NID = 0Bh): PinCap

Reg	Byte 4 (Bits 31:24)	Byte 3 (Bits 23:16)	Byte 2 (Bits 15:8)	Byte 1 (Bits 7:0)
Set				
Get	F000Ch			

Field Name	Bits	R/W	Default	Reset
Rsvd2	31:17	R	0000h	N/A (Hard-coded)
Reserved.				
EapdCap	16	R	1h	N/A (Hard-coded)
EAPD support: 1 = yes, 0 = no.				
VrefCntrl	15:8	R	00h	N/A (Hard-coded)
Vref support: bit 7 = Reserved bit 6 = Reserved bit 5 = 100% support (1 = yes, 0 = no) bit 4 = 80% support (1 = yes, 0 = no) bit 3 = Reserved bit 2 = GND support (1 = yes, 0 = no) bit 1 = 50% support (1 = yes, 0 = no) bit 0 = Hi-Z support (1 = yes, 0 = no)				
Rsvd1	7	R	0h	N/A (Hard-coded)
Reserved.				

Field Name	Bits	R/W	Default	Reset
BalancedIO	6	R	0h	N/A (Hard-coded)
Balanced I/O support: 1 = yes, 0 = no.				
InCap	5	R	0h	N/A (Hard-coded)
Input support: 1 = yes, 0 = no.				
OutCap	4	R	1h	N/A (Hard-coded)
Output support: 1 = yes, 0 = no.				
HdphDrvCap	3	R	1h	N/A (Hard-coded)
Headphone amp present: 1 = yes, 0 = no.				
PresDtctCap	2	R	1h	N/A (Hard-coded)
Presence detection support: 1 = yes, 0 = no.				
TrigRqd	1	R	0h	N/A (Hard-coded)
Trigger required for impedance sense: 1 = yes, 0 = no.				
ImpSenseCap	0	R	0h	N/A (Hard-coded)
Impedance sense support: 1 = yes, 0 = no.				

### 7.6.2. PortB (NID = 0Bh): ConLst

Reg	Byte 4 (Bits 31:24)	Byte 3 (Bits 23:16)	Byte 2 (Bits 15:8)	Byte 1 (Bits 7:0)
Set				
Get	F000Eh			

Field Name	Bits	R/W	Default	Reset
Rsvd	31:8	R	000000h	N/A (Hard-coded)
Reserved.				
LForm	7	R	0h	N/A (Hard-coded)
Connection list format: 1 = long-form (15-bit) NID entries, 0 = short-form (7-bit) NID entries.				
ConL	6:0	R	03h	N/A (Hard-coded)
Number of NID entries in connection list.				

**7.6.3. PortB (NID = 0Bh): ConLstEntry0**

Reg	Byte 4 (Bits 31:24)	Byte 3 (Bits 23:16)	Byte 2 (Bits 15:8)	Byte 1 (Bits 7:0)
Set				
Get	F0200h			

Field Name	Bits	R/W	Default	Reset
ConL3	31:24	R	00h	N/A (Hard-coded)
	DAC2 Converter widget (0x22)			
ConL2	23:16	R	1Ch	N/A (Hard-coded)
	MixerOutVol Selector widget (0x1C)			
ConL1	15:8	R	14h	N/A (Hard-coded)
	DAC1 Converter widget (0x14)			
ConL0	7:0	R	13h	N/A (Hard-coded)
	DAC0 Converter widget (0x13)			

**7.6.4. PortB (NID = 0Bh): ConSelectCtrl**

Reg	Byte 4 (Bits 31:24)	Byte 3 (Bits 23:16)	Byte 2 (Bits 15:8)	Byte 1 (Bits 7:0)
Set				701h
Get	F0100h			

Field Name	Bits	R/W	Default	Reset
Rsvd	31:2	R	00000000h	N/A (Hard-coded)
	Reserved.			
Index	1:0	RW	0h	POR - DAFG - ULR
	Connection select control index.			

**7.6.5. PortB (NID = 0Bh): PwrState**

Reg	Byte 4 (Bits 31:24)	Byte 3 (Bits 23:16)	Byte 2 (Bits 15:8)	Byte 1 (Bits 7:0)
Set				705h
Get	F0500h			

# 92HD81

## SINGLE CHIP PC AUDIO SYSTEM, CODEC+SPEAKER AMPLIFIER+CAPLESS HP+LDO

Field Name	Bits	R/W	Default	Reset
Rsvd4	31:11	R	000000h	N/A (Hard-coded)
	Reserved.			
SettingsReset	10	R	1h	POR - DAFG - ULR
	Indicates if any persistent settings in this Widget have been reset. Cleared by PwrState 'Get', or a 'Set' to any Verb in this Widget.			
Rsvd3	9	R	0h	N/A (Hard-coded)
	Reserved.			
Error	8	R	0h	POR - DAFG - ULR
	Error indicator: 1 = cannot enter requested power state, 0 = no problem with requested power state.			
Rsvd2	7:6	R	0h	N/A (Hard-coded)
	Reserved.			
Act	5:4	R	3h	POR - DAFG - LR
	Actual power state of this widget.			
Rsvd1	3:2	R	0h	N/A (Hard-coded)
	Reserved.			
Set	1:0	RW	0h	POR - DAFG - LR
	Current power state setting for this widget.			

### 7.6.6. PortB (NID = 0Bh): PinWCntrl

Reg	Byte 4 (Bits 31:24)	Byte 3 (Bits 23:16)	Byte 2 (Bits 15:8)	Byte 1 (Bits 7:0)
Set				707h
Get	F0700h			

Field Name	Bits	R/W	Default	Reset
Rsvd2	31:8	R	000000h	N/A (Hard-coded)
	Reserved.			
HPhnEn	7	RW	0h	POR - DAFG - ULR
	Headphone amp enable: 1 = enabled, 0 = disabled.			

Field Name	Bits	R/W	Default	Reset
OutEn	6	RW	0h	POR - DAFG - ULR
	Output enable: 1 = enabled, 0 = disabled.			
Rsvd1	5:0	RW	00h	N/A (Hard-coded)
	Reserved.			

### 7.6.7. PortB (NID = 0Bh): UnsolResp

Reg	Byte 4 (Bits 31:24)	Byte 3 (Bits 23:16)	Byte 2 (Bits 15:8)	Byte 1 (Bits 7:0)
Set				708h
Get	F0800h			

Field Name	Bits	R/W	Default	Reset
Rsvd2	31:8	R	000000h	N/A (Hard-coded)
	Reserved.			
En	7	RW	0h	POR - DAFG - ULR
	Unsolicited response enable (also enables Wake events for this Widget): 1 = enabled, 0 = disabled.			
Rsvd1	6	R	0h	N/A (Hard-coded)
	Reserved.			
Tag	5:0	RW	00h	POR - DAFG - ULR
	Software programmable field returned in top six bits (31:26) of every Unsolicited Response generated by this node.			

### 7.6.8. PortB (NID = 0Bh): ChSense

Reg	Byte 4 (Bits 31:24)	Byte 3 (Bits 23:16)	Byte 2 (Bits 15:8)	Byte 1 (Bits 7:0)
Set				709h
Get	F0900h			

Field Name	Bits	R/W	Default	Reset
PresDtct	31	R	0h	POR
	Presence detection indicator: 1 = presence detected; 0 = presence not detected.			
Rsvd	30:0	R	00000000h	N/A (Hard-coded)
	Reserved.			

### 7.6.9. PortB (NID = 0Bh): EAPDBTLLR

Reg	Byte 4 (Bits 31:24)	Byte 3 (Bits 23:16)	Byte 2 (Bits 15:8)	Byte 1 (Bits 7:0)
Set				70Ch
Get	F0C00h			

Field Name	Bits	R/W	Default	Reset
Rsvd2	31:2	R	00000000h	N/A (Hard-coded)
	Reserved.			
EAPD	1	RW	1h	POR - DAFG - ULR
	EAPD control: 1 = set EAPD pin to 1 (powered) up if this pin is powered up, 0 = set EAPD pin to 0.			
Rsvd1	0	R	0h	N/A (Hard-coded)
	Reserved.			

### 7.6.10. PortB (NID = 0Bh): ConfigDefault

Reg	Byte 4 (Bits 31:24)	Byte 3 (Bits 23:16)	Byte 2 (Bits 15:8)	Byte 1 (Bits 7:0)
Set	71Fh	71Eh	71Dh	71Ch
Get	F1F00h / F1E00h / F1D00h / F1C00h			

**92HD81**

**SINGLE CHIP PC AUDIO SYSTEM, CODEC+SPEAKER AMPLIFIER+CAPLESS HP+LDO**

Field Name	Bits	R/W	Default	Reset
PortConnectivity	31:30	RW	0h	POR
Port connectivity: 0h = Port complex is connected to a jack 1h = No physical connection for port 2h = Fixed function device is attached 3h = Both jack and internal device attached (info in all other fields refers to integrated device, any presence detection refers to jack)				
Location	29:24	RW	02h	POR
Location  Bits [5..4]: 0h = External on primary chassis 1h = Internal 2h = Separate chassis 3h = Other  Bits [3..0]: 0h = N/A 1h = Rear 2h = Front 3h = Left 4h = Right 5h = Top 6h = Bottom 7h-9h = Special Ah-Fh = Reserved				
Device	23:20	RW	2h	POR
Default device: 0h = Line out 1h = Speaker 2h = HP out 3h = CD 4h = SPDIF Out 5h = Digital other out 6h = Modem line side 7h = Modem handset side 8h = Line in 9h = Aux Ah = Mic in Bh = Telephony Ch = SPDIF In Dh = Digital other in Eh = Reserved Fh = Other				

**92HD81**

**SINGLE CHIP PC AUDIO SYSTEM, CODEC+SPEAKER AMPLIFIER+CAPLESS HP+LDO**

Field Name	Bits	R/W	Default	Reset
ConnectionType	19:16	RW	1h	POR
	Connection type: 0h = Unknown 1h = 1/8" stereo/mono 2h = 1/4" stereo/mono 3h = ATAPI internal 4h = RCA 5h = Optical 6h = Other digital 7h = Other analog 8h = Multichannel analog (DIN) 9h = XLR/Professional Ah = RJ-11 (modem) Bh = Combination Ch-Eh = Reserved Fh = Other			
Color	15:12	RW	1h	POR
	Color: 0h = Unknown 1h = Black 2h = Grey 3h = Blue 4h = Green 5h = Red 6h = Orange 7h = Yellow 8h = Purple 9h = Pink Ah-Dh = Reserved Eh = White Fh = Other			
Misc	11:8	RW	0h	POR
	Miscellaneous: Bits [3..1] = Reserved Bit 0 = Jack detect override			
Association	7:4	RW	1h	POR
	Default association.			
Sequence	3:0	RW	0h	POR
	Sequence.			



### 7.7. PortC (NID = 0Ch): WCap

Port C is input only on the TA revision. RA revision is output capable

Reg	Byte 4 (Bits 31:24)	Byte 3 (Bits 23:16)	Byte 2 (Bits 15:8)	Byte 1 (Bits 7:0)
Set				
Get	F0009h			

Field Name	Bits	R/W	Default	Reset
Rsvd2	31:24	R	00h	N/A (Hard-coded)
	Reserved.			
Type	23:20	R	4h	N/A (Hard-coded)
	Widget type: 0h = Out Converter 1h = In Converter 2h = Summing (Mixer) 3h = Selector (Mux) 4h = Pin Complex 5h = Power 6h = Volume Knob 7h = Beep Generator 8h-Eh = Reserved Fh = Vendor Defined			
Delay	19:16	R	0h	N/A (Hard-coded)
	Number of sample delays through widget.			
Rsvd1	15:12	R	0h	N/A (Hard-coded)
	Reserved.			
SwapCap	11	R	0h	N/A (Hard-coded)
	Left/right swap support: 1 = yes, 0 = no.			
PwrCntrl	10	R	1h	N/A (Hard-coded)
	Power state support: 1 = yes, 0 = no.			
Dig	9	R	0h	N/A (Hard-coded)
	Digital stream support: 1 = yes (digital), 0 = no (analog).			
ConnList	8	R	1h	N/A (Hard-coded)
	Connection list present: 1 = yes, 0 = no.			

Field Name	Bits	R/W	Default	Reset
UnSolCap	7	R	1h	N/A (Hard-coded)
	Unsolicited response support: 1 = yes, 0 = no.			
ProcWidget	6	R	0h	N/A (Hard-coded)
	Processing state support: 1 = yes, 0 = no.			
Stripe	5	R	0h	N/A (Hard-coded)
	Striping support: 1 = yes, 0 = no.			
FormatOvrd	4	R	0h	N/A (Hard-coded)
	Stream format override: 1 = yes, 0 = no.			
AmpParOvrd	3	R	0h	N/A (Hard-coded)
	Amplifier capabilities override: 1 = yes, no.			
OutAmpPrsnt	2	R	0h	N/A (Hard-coded)
	Output amp present: 1 = yes, 0 = no.			
InAmpPrsnt	1	R	1h	N/A (Hard-coded)
	Input amp present: 1 = yes, 0 = no.			
Stereo	0	R	1h	N/A (Hard-coded)
	Stereo stream support: 1 = yes (stereo), 0 = no (mono).			

### 7.7.1. PortC (NID = 0Ch): PinCap

Reg	Byte 4 (Bits 31:24)	Byte 3 (Bits 23:16)	Byte 2 (Bits 15:8)	Byte 1 (Bits 7:0)
Set				
Get	F000Ch			

Field Name	Bits	R/W	Default	Reset
Rsvd2	31:17	R	0000h	N/A (Hard-coded)
	Reserved.			
EapdCap	16	R	1h	N/A (Hard-coded)
	EAPD support: 1 = yes, 0 = no.			

# 92HD81

## SINGLE CHIP PC AUDIO SYSTEM, CODEC+SPEAKER AMPLIFIER+CAPLESS HP+LDO

Field Name	Bits	R/W	Default	Reset
VrefCntrl	15:8	R	17h	N/A (Hard-coded)
	Vref support: bit 7 = Reserved bit 6 = Reserved bit 5 = 100% support (1 = yes, 0 = no) bit 4 = 80% support (1 = yes, 0 = no) bit 3 = Reserved bit 2 = GND support (1 = yes, 0 = no) bit 1 = 50% support (1 = yes, 0 = no) bit 0 = Hi-Z support (1 = yes, 0 = no)			
Rsvd1	7	R	0h	N/A (Hard-coded)
	Reserved.			
BalancedIO	6	R	0h	N/A (Hard-coded)
	Balanced I/O support: 1 = yes, 0 = no.			
InCap	5	R	1h	N/A (Hard-coded)
	Input support: 1 = yes, 0 = no.			
OutCap	4	R	1h	N/A (Hard-coded)
	Output support: 1 = yes, 0 = no.			
HdphDrvCap	3	R	0h	N/A (Hard-coded)
	Headphone amp present: 1 = yes, 0 = no.			
PresDtctCap	2	R	1h	N/A (Hard-coded)
	Presence detection support: 1 = yes, 0 = no.			
TrigRqd	1	R	0h	N/A (Hard-coded)
	Trigger required for impedance sense: 1 = yes, 0 = no.			
ImpSenseCap	0	R	0h	N/A (Hard-coded)
	Impedance sense support: 1 = yes, 0 = no.			

### 7.7.2. PortC (NID = 0Ch): ConLst

Reg	Byte 4 (Bits 31:24)	Byte 3 (Bits 23:16)	Byte 2 (Bits 15:8)	Byte 1 (Bits 7:0)
Set				
Get	F000Eh			

Field Name	Bits	R/W	Default	Reset
Rsvd	31:8	R	000000h	N/A (Hard-coded)
	Reserved.			
LForm	7	R	0h	N/A (Hard-coded)
	Connection list format: 1 = long-form (15-bit) NID entries, 0 = short-form (7-bit) NID entries.			
ConL	6:0	R	03h	N/A (Hard-coded)
	Number of NID entries in connection list.			

### 7.7.3. PortC (NID = 0Ch): ConLstEntry0

Reg	Byte 4 (Bits 31:24)	Byte 3 (Bits 23:16)	Byte 2 (Bits 15:8)	Byte 1 (Bits 7:0)
Set				
Get	F0200h			

Field Name	Bits	R/W	Default	Reset
ConL3	31:24	R	00h	N/A (Hard-coded)
	DAC2 Converter widget (0x22)			
ConL2	23:16	R	1Ch	N/A (Hard-coded)
	MixerOutVol Selector widget (0x1C)			
ConL1	15:8	R	14h	N/A (Hard-coded)
	DAC1 Converter widget (0x14)			
ConL0	7:0	R	13h	N/A (Hard-coded)
	DAC0 Converter widget (0x13)			

### 7.7.4. PortC (NID = 0Ch): InAmpLeft

Reg	Byte 4 (Bits 31:24)	Byte 3 (Bits 23:16)	Byte 2 (Bits 15:8)	Byte 1 (Bits 7:0)
Set				360h
Get	B2000h			

Field Name	Bits	R/W	Default	Reset
Rsvd1	31:2	R	00000000h	N/A (Hard-coded)
	Reserved.			
Gain	1:0	RW	0h	POR - DAFG - ULR
	Amp gain step number (see InAmpCap parameter pertaining to this widget).			

### 7.7.5. PortC (NID = 0Ch): InAmpRight

Reg	Byte 4 (Bits 31:24)	Byte 3 (Bits 23:16)	Byte 2 (Bits 15:8)	Byte 1 (Bits 7:0)
Set				350h
Get	B0000h			

Field Name	Bits	R/W	Default	Reset
Rsvd1	31:2	R	00000000h	N/A (Hard-coded)
	Reserved.			
Gain	1:0	RW	0h	POR - DAFG - ULR
	Amp gain step number (see InAmpCap parameter pertaining to this widget).			

### 7.7.6. PortC (NID = 0Ch): ConSelectCtrl

Reg	Byte 4 (Bits 31:24)	Byte 3 (Bits 23:16)	Byte 2 (Bits 15:8)	Byte 1 (Bits 7:0)
Set				701h
Get	F0100h			

Field Name	Bits	R/W	Default	Reset
Rsvd	31:2	R	00000000h	N/A (Hard-coded)
	Reserved.			
Index	1:0	RW	0h	POR - DAFG - ULR
	Connection select control index.			

**7.7.7. PortC (NID = 0Ch): PwrState**

Reg	Byte 4 (Bits 31:24)	Byte 3 (Bits 23:16)	Byte 2 (Bits 15:8)	Byte 1 (Bits 7:0)
Set				705h
Get	F0500h			

Field Name	Bits	R/W	Default	Reset
Rsvd4	31:11	R	000000h	N/A (Hard-coded)
	Reserved.			
SettingsReset	10	R	1h	POR - DAFG - ULR
	Indicates if any persistent settings in this Widget have been reset. Cleared by PwrState 'Get', or a 'Set' to any Verb in this Widget.			
Rsvd3	9	R	0h	N/A (Hard-coded)
	Reserved.			
Error	8	R	0h	POR - DAFG - ULR
	Error indicator: 1 = cannot enter requested power state, 0 = no problem with requested power state.			
Rsvd2	7:6	R	0h	N/A (Hard-coded)
	Reserved.			
Act	5:4	R	3h	POR - DAFG - LR
	Actual power state of this widget.			
Rsvd1	3:2	R	0h	N/A (Hard-coded)
	Reserved.			
Set	1:0	RW	0h	POR - DAFG - LR
	Current power state setting for this widget.			

**7.7.8. PortC (NID = 0Ch): PinWCntrl**

Reg	Byte 4 (Bits 31:24)	Byte 3 (Bits 23:16)	Byte 2 (Bits 15:8)	Byte 1 (Bits 7:0)
Set				707h
Get	F0700h			

Field Name	Bits	R/W	Default	Reset
Rsvd2	31:7	R	000000h	N/A (Hard-coded)
	Reserved.			
OutEn	6	RW	0h	POR - DAFG - ULR
	Output enable: 1 = enabled, 0 = disabled.			
InEn	5	RW	0h	POR - DAFG - ULR
	Input enable: 1 = enabled, 0 = disabled.			
Rsvd1	4:3	R	0h	N/A (Hard-coded)
	Reserved.			
VRefEn	2:0	RW	0h	POR - DAFG - ULR
	Vref selection (See VrefCntrl field of PinCap parameter for supported selections): 000b= HI-Z 001b= 50% 010b= GND 011b= Reserved 100b= 80% 101b= 100% 110b= Reserved 111b= Reserved			

### 7.7.9. PortC (NID = 0Ch): UnsolResp

Reg	Byte 4 (Bits 31:24)	Byte 3 (Bits 23:16)	Byte 2 (Bits 15:8)	Byte 1 (Bits 7:0)
Set				708h
Get	F0800h			

Field Name	Bits	R/W	Default	Reset
Rsvd2	31:8	R	000000h	N/A (Hard-coded)
	Reserved.			
En	7	RW	0h	POR - DAFG - ULR
	Unsolicted response enable (also enables Wake events for this Widget): 1 = enabled, 0 = disabled.			

Field Name	Bits	R/W	Default	Reset
Rsvd1	6	R	0h	N/A (Hard-coded)
	Reserved.			
Tag	5:0	RW	00h	POR - DAFG - ULR
	Software programmable field returned in top six bits (31:26) of every Unsolicited Response generated by this node.			

#### 7.7.10. PortC (NID = 0Ch): ChSense

Reg	Byte 4 (Bits 31:24)	Byte 3 (Bits 23:16)	Byte 2 (Bits 15:8)	Byte 1 (Bits 7:0)
Set				709h
Get	F0900h			

Field Name	Bits	R/W	Default	Reset
PresDtct	31	R	0h	POR
	Presence detection indicator: 1 = presence detected; 0 = presence not detected.			
Rsvd	30:0	R	00000000h	N/A (Hard-coded)
	Reserved.			

#### 7.7.11. PortC (NID = 0Ch): EAPDBTLLR

Reg	Byte 4 (Bits 31:24)	Byte 3 (Bits 23:16)	Byte 2 (Bits 15:8)	Byte 1 (Bits 7:0)
Set				70Ch
Get	F0C00h			

Field Name	Bits	R/W	Default	Reset
Rsvd2	31:2	R	00000000h	N/A (Hard-coded)
	Reserved.			
EAPD	1	RW	1h	POR - DAFG - ULR
	EAPD control: 1 = set EAPD pin to 1 (powered) up if this pin is powered up, 0 = set EAPD pin to 0.			



Field Name	Bits	R/W	Default	Reset
Rsvd1	0	R	0h	N/A (Hard-coded)
Reserved.				

**7.7.12. PortC (NID = 0Ch): ConfigDefault**

Reg	Byte 4 (Bits 31:24)	Byte 3 (Bits 23:16)	Byte 2 (Bits 15:8)	Byte 1 (Bits 7:0)
Set	71Fh	71Eh	71Dh	71Ch
Get	F1F00h / F1E00h / F1D00h / F1C00h			

Field Name	Bits	R/W	Default	Reset
PortConnectivity	31:30	RW	0h	POR
Port connectivity: 0h = Port complex is connected to a jack 1h = No physical connection for port 2h = Fixed function device is attached 3h = Both jack and internal device attached (info in all other fields refers to integrated device, any presence detection refers to jack)				
Location	29:24	RW	02h	POR
Location  Bits [5..4]: 0h = External on primary chassis 1h = Internal 2h = Separate chassis 3h = Other  Bits [3..0]: 0h = N/A 1h = Rear 2h = Front 3h = Left 4h = Right 5h = Top 6h = Bottom 7h-9h = Special Ah-Fh = Reserved				

# 92HD81

## SINGLE CHIP PC AUDIO SYSTEM, CODEC+SPEAKER AMPLIFIER+CAPLESS HP+LDO

Field Name	Bits	R/W	Default	Reset
Device	23:20	RW	Ah	POR
	Default device: 0h = Line out 1h = Speaker 2h = HP out 3h = CD 4h = SPDIF Out 5h = Digital other out 6h = Modem line side 7h = Modem handset side 8h = Line in 9h = Aux Ah = Mic in Bh = Telephony Ch = SPDIF In Dh = Digital other in Eh = Reserved Fh = Other			
ConnectionType	19:16	RW	1h	POR
	Connection type: 0h = Unknown 1h = 1/8" stereo/mono 2h = 1/4" stereo/mono 3h = ATAPI internal 4h = RCA 5h = Optical 6h = Other digital 7h = Other analog 8h = Multichannel analog (DIN) 9h = XLR/Professional Ah = RJ-11 (modem) Bh = Combination Ch-Eh = Reserved Fh = Other			

# 92HD81

## SINGLE CHIP PC AUDIO SYSTEM, CODEC+SPEAKER AMPLIFIER+CAPLESS HP+LDO

Field Name	Bits	R/W	Default	Reset
Color	15:12	RW	9h	POR
	Color: 0h = Unknown 1h = Black 2h = Grey 3h = Blue 4h = Green 5h = Red 6h = Orange 7h = Yellow 8h = Purple 9h = Pink Ah-Dh = Reserved Eh = White Fh = Other			
Misc	11:8	RW	0h	POR
	Miscellaneous: Bits [3..1] = Reserved Bit 0 = Jack detect override			
Association	7:4	RW	2h	POR
	Default association.			
Sequence	3:0	RW	0h	POR
	Sequence.			

### 7.8. PortD (NID = 0Dh): WCap

Reg	Byte 4 (Bits 31:24)	Byte 3 (Bits 23:16)	Byte 2 (Bits 15:8)	Byte 1 (Bits 7:0)
Set				
Get	F0009h			

Field Name	Bits	R/W	Default	Reset
Rsvd2	31:24	R	00h	N/A (Hard-coded)
	Reserved.			

# 92HD81

## SINGLE CHIP PC AUDIO SYSTEM, CODEC+SPEAKER AMPLIFIER+CAPLESS HP+LDO

Field Name	Bits	R/W	Default	Reset
Type	23:20	R	4h	N/A (Hard-coded)
Widget type: 0h = Out Converter 1h = In Converter 2h = Summing (Mixer) 3h = Selector (Mux) 4h = Pin Complex 5h = Power 6h = Volume Knob 7h = Beep Generator 8h-Eh = Reserved Fh = Vendor Defined				
Delay	19:16	R	0h	N/A (Hard-coded)
Number of sample delays through widget.				
Rsvd1	15:12	R	0h	N/A (Hard-coded)
Reserved.				
SwapCap	11	R	0h	N/A (Hard-coded)
Left/right swap support: 1 = yes, 0 = no.				
PwrCntrl	10	R	1h	N/A (Hard-coded)
Power state support: 1 = yes, 0 = no.				
Dig	9	R	0h	N/A (Hard-coded)
Digital stream support: 1 = yes (digital), 0 = no (analog).				
ConnList	8	R	1h	N/A (Hard-coded)
Connection list present: 1 = yes, 0 = no.				
UnSolCap	7	R	0h	N/A (Hard-coded)
Unsolicited response support: 1 = yes, 0 = no.				
ProcWidget	6	R	0h	N/A (Hard-coded)
Processing state support: 1 = yes, 0 = no.				
Stripe	5	R	0h	N/A (Hard-coded)
Striping support: 1 = yes, 0 = no.				
FormatOvrd	4	R	0h	N/A (Hard-coded)
Stream format override: 1 = yes, 0 = no.				

Field Name	Bits	R/W	Default	Reset
AmpParOvrd	3	R	0h	N/A (Hard-coded)
Amplifier capabilities override: 1 = yes, no.				
OutAmpPrsnt	2	R	0h	N/A (Hard-coded)
Output amp present: 1 = yes, 0 = no.				
InAmpPrsnt	1	R	0h	N/A (Hard-coded)
Input amp present: 1 = yes, 0 = no.				
Stereo	0	R	1h	N/A (Hard-coded)
Stereo stream support: 1 = yes (stereo), 0 = no (mono).				

### 7.8.1. PortD (NID = 0Dh): PinCap

Reg	Byte 4 (Bits 31:24)	Byte 3 (Bits 23:16)	Byte 2 (Bits 15:8)	Byte 1 (Bits 7:0)
Set				
Get	F000Ch			

Field Name	Bits	R/W	Default	Reset
Rsvd2	31:17	R	0000h	N/A (Hard-coded)
Reserved.				
EapdCap	16	R	1h	N/A (Hard-coded)
EAPD support: 1 = yes, 0 = no.				
VrefCntrl	15:8	R	00h	N/A (Hard-coded)
Vref support: bit 7 = Reserved bit 6 = Reserved bit 5 = 100% support (1 = yes, 0 = no) bit 4 = 80% support (1 = yes, 0 = no) bit 3 = Reserved bit 2 = GND support (1 = yes, 0 = no) bit 1 = 50% support (1 = yes, 0 = no) bit 0 = Hi-Z support (1 = yes, 0 = no)				
Rsvd1	7	R	0h	N/A (Hard-coded)
Reserved.				

Field Name	Bits	R/W	Default	Reset
BalancedIO	6	R	1h	N/A (Hard-coded)
Balanced I/O support: 1 = yes, 0 = no.				
InCap	5	R	0h	N/A (Hard-coded)
Input support: 1 = yes, 0 = no.				
OutCap	4	R	1h	N/A (Hard-coded)
Output support: 1 = yes, 0 = no.				
HdphDrvCap	3	R	0h	N/A (Hard-coded)
Headphone amp present: 1 = yes, 0 = no.				
PresDtctCap	2	R	0h	N/A (Hard-coded)
Presence detection support: 1 = yes, 0 = no.				
TrigRqd	1	R	0h	N/A (Hard-coded)
Trigger required for impedance sense: 1 = yes, 0 = no.				
ImpSenseCap	0	R	0h	N/A (Hard-coded)
Impedance sense support: 1 = yes, 0 = no.				

### 7.8.2. PortD (NID = 0Dh): ConLst

Reg	Byte 4 (Bits 31:24)	Byte 3 (Bits 23:16)	Byte 2 (Bits 15:8)	Byte 1 (Bits 7:0)
Set				
Get	F000Eh			

Field Name	Bits	R/W	Default	Reset
Rsvd	31:8	R	000000h	N/A (Hard-coded)
Reserved.				
LForm	7	R	0h	N/A (Hard-coded)
Connection list format: 1 = long-form (15-bit) NID entries, 0 = short-form (7-bit) NID entries.				
ConL	6:0	R	03h	N/A (Hard-coded)
Number of NID entries in connection list.				

**7.8.3. PortD (NID = 0Dh): ConLstEntry0**

Reg	Byte 4 (Bits 31:24)	Byte 3 (Bits 23:16)	Byte 2 (Bits 15:8)	Byte 1 (Bits 7:0)
Set				
Get	F0200h			

Field Name	Bits	R/W	Default	Reset
ConL3	31:24	R	00h	N/A (Hard-coded)
	DAC2 Converter widget (0x22)			
ConL2	23:16	R	1Ch	N/A (Hard-coded)
	MixerOutVol Selector widget (0x1C)			
ConL1	15:8	R	14h	N/A (Hard-coded)
	DAC1 Converter widget (0x14)			
ConL0	7:0	R	13h	N/A (Hard-coded)
	DAC0 Converter widget (0x13)			

**7.8.4. PortD (NID = 0Dh): ConSelectCtrl**

Reg	Byte 4 (Bits 31:24)	Byte 3 (Bits 23:16)	Byte 2 (Bits 15:8)	Byte 1 (Bits 7:0)
Set				701h
Get	F0100h			

Field Name	Bits	R/W	Default	Reset
Rsvd	31:2	R	00000000h	N/A (Hard-coded)
	Reserved.			
Index	1:0	RW	0h	POR - DAFG - ULR
	Connection select control index.			

**7.8.5. PortD (NID = 0Dh): PwrState**

Reg	Byte 4 (Bits 31:24)	Byte 3 (Bits 23:16)	Byte 2 (Bits 15:8)	Byte 1 (Bits 7:0)
Set				705h
Get	F0500h			

# 92HD81

## SINGLE CHIP PC AUDIO SYSTEM, CODEC+SPEAKER AMPLIFIER+CAPLESS HP+LDO

Field Name	Bits	R/W	Default	Reset
Rsvd4	31:11	R	000000h	N/A (Hard-coded)
	Reserved.			
SettingsReset	10	R	1h	POR - DAFG - ULR
	Indicates if any persistent settings in this Widget have been reset. Cleared by PwrState 'Get', or a 'Set' to any Verb in this Widget.			
Rsvd3	9	R	0h	N/A (Hard-coded)
	Reserved.			
Error	8	R	0h	POR - DAFG - ULR
	Error indicator: 1 = cannot enter requested power state, 0 = no problem with requested power state.			
Rsvd2	7:6	R	0h	N/A (Hard-coded)
	Reserved.			
Act	5:4	R	3h	POR - DAFG - LR
	Actual power state of this widget.			
Rsvd1	3:2	R	0h	N/A (Hard-coded)
	Reserved.			
Set	1:0	RW	0h	POR - DAFG - LR
	Current power state setting for this widget.			

### 7.8.6. PortD (NID = 0Dh): PinWCntrl

Reg	Byte 4 (Bits 31:24)	Byte 3 (Bits 23:16)	Byte 2 (Bits 15:8)	Byte 1 (Bits 7:0)
Set				707h
Get	F0700h			

Field Name	Bits	R/W	Default	Reset
Rsvd2	31:7	R	000000h	N/A (Hard-coded)
	Reserved.			



Field Name	Bits	R/W	Default	Reset
OutEn	6	RW	1h (YC/YD) 0h (UA/TA/RA)	POR - DAFG - ULR
	Output enable: 1 = enabled, 0 = disabled.			
Rsvd1	5:0	R	0h	N/A (Hard-coded)
	Reserved.			

### 7.8.7. PortD (NID = 0Dh): EAPDBTLLR

Reg	Byte 4 (Bits 31:24)	Byte 3 (Bits 23:16)	Byte 2 (Bits 15:8)	Byte 1 (Bits 7:0)
Set				70Ch
Get	F0C00h			

Field Name	Bits	R/W	Default	Reset
Rsvd2	31:2	R	00000000h	N/A (Hard-coded)
	Reserved.			
EAPD	1	RW	1h	POR - DAFG - ULR
	EAPD control: 1 = set EAPD pin to 1 (powered) up if this pin is powered up, 0 = set EAPD pin to 0.			
Rsvd1	0	R	0h	N/A (Hard-coded)
	Reserved.			

### 7.8.8. PortD (NID = 0Dh): ConfigDefault

Reg	Byte 4 (Bits 31:24)	Byte 3 (Bits 23:16)	Byte 2 (Bits 15:8)	Byte 1 (Bits 7:0)
Set	71Fh	71Eh	71Dh	71Ch
Get	F1F00h / F1E00h / F1D00h / F1C00h			

**92HD81**

**SINGLE CHIP PC AUDIO SYSTEM, CODEC+SPEAKER AMPLIFIER+CAPLESS HP+LDO**

Field Name	Bits	R/W	Default	Reset
PortConnectivity	31:30	RW	2h	POR
Port connectivity: 0h = Port complex is connected to a jack 1h = No physical connection for port 2h = Fixed function device is attached 3h = Both jack and internal device attached (info in all other fields refers to integrated device, any presence detection refers to jack)				
Location	29:24	RW	10h	POR
Location  Bits [5..4]: 0h = External on primary chassis 1h = Internal 2h = Separate chassis 3h = Other  Bits [3..0]: 0h = N/A 1h = Rear 2h = Front 3h = Left 4h = Right 5h = Top 6h = Bottom 7h-9h = Special Ah-Fh = Reserved				
Device	23:20	RW	1h	POR
Default device: 0h = Line out 1h = Speaker 2h = HP out 3h = CD 4h = SPDIF Out 5h = Digital other out 6h = Modem line side 7h = Modem handset side 8h = Line in 9h = Aux Ah = Mic in Bh = Telephony Ch = SPDIF In Dh = Digital other in Eh = Reserved Fh = Other				

# 92HD81

## SINGLE CHIP PC AUDIO SYSTEM, CODEC+SPEAKER AMPLIFIER+CAPLESS HP+LDO

Field Name	Bits	R/W	Default	Reset
ConnectionType	19:16	RW	7h	POR
	Connection type: 0h = Unknown 1h = 1/8" stereo/mono 2h = 1/4" stereo/mono 3h = ATAPI internal 4h = RCA 5h = Optical 6h = Other digital 7h = Other analog 8h = Multichannel analog (DIN) 9h = XLR/Professional Ah = RJ-11 (modem) Bh = Combination Ch-Eh = Reserved Fh = Other			
Color	15:12	RW	0h	POR
	Color: 0h = Unknown 1h = Black 2h = Grey 3h = Blue 4h = Green 5h = Red 6h = Orange 7h = Yellow 8h = Purple 9h = Pink Ah-Dh = Reserved Eh = White Fh = Other			
Misc	11:8	RW	1h	POR
	Miscellaneous: Bits [3..1] = Reserved Bit 0 = Jack detect override			
Association	7:4	RW	3h	POR
	Default association.			
Sequence	3:0	RW	0h	POR
	Sequence.			

## 7.9. PortE (NID = 0Eh): WCap

Reg	Byte 4 (Bits 31:24)	Byte 3 (Bits 23:16)	Byte 2 (Bits 15:8)	Byte 1 (Bits 7:0)
Set				
Get	F0009h			

Field Name	Bits	R/W	Default	Reset
Rsvd2	31:24	R	00h	N/A (Hard-coded)
	Reserved.			
Type	23:20	R	4h	N/A (Hard-coded)
	Widget type: 0h = Out Converter 1h = In Converter 2h = Summing (Mixer) 3h = Selector (Mux) 4h = Pin Complex 5h = Power 6h = Volume Knob 7h = Beep Generator 8h-Eh = Reserved Fh = Vendor Defined			
Delay	19:16	R	0h	N/A (Hard-coded)
	Number of sample delays through widget.			
Rsvd1	15:12	R	0h	N/A (Hard-coded)
	Reserved.			
SwapCap	11	R	0h	N/A (Hard-coded)
	Left/right swap support: 1 = yes, 0 = no.			
PwrCntrl	10	R	1h	N/A (Hard-coded)
	Power state support: 1 = yes, 0 = no.			
Dig	9	R	0h	N/A (Hard-coded)
	Digital stream support: 1 = yes (digital), 0 = no (analog).			
ConnList	8	R	1h	N/A (Hard-coded)
	Connection list present: 1 = yes, 0 = no.			
UnSolCap	7	R	1h	N/A (Hard-coded)
	Unsolicited response support: 1 = yes, 0 = no.			

# 92HD81

## SINGLE CHIP PC AUDIO SYSTEM, CODEC+SPEAKER AMPLIFIER+CAPLESS HP+LDO

Field Name	Bits	R/W	Default	Reset
ProcWidget	6	R	0h	N/A (Hard-coded)
	Processing state support: 1 = yes, 0 = no.			
Stripe	5	R	0h	N/A (Hard-coded)
	Striping support: 1 = yes, 0 = no.			
FormatOvr	4	R	0h	N/A (Hard-coded)
	Stream format override: 1 = yes, 0 = no.			
AmpParOvr	3	R	0h	N/A (Hard-coded)
	Amplifier capabilities override: 1 = yes, no.			
OutAmpPrsnt	2	R	0h	N/A (Hard-coded)
	Output amp present: 1 = yes, 0 = no.			
InAmpPrsnt	1	R	1h	N/A (Hard-coded)
	Input amp present: 1 = yes, 0 = no.			
Stereo	0	R	1h	N/A (Hard-coded)
	Stereo stream support: 1 = yes (stereo), 0 = no (mono).			

### 7.9.1. PortE (NID = 0Eh): PinCap

Reg	Byte 4 (Bits 31:24)	Byte 3 (Bits 23:16)	Byte 2 (Bits 15:8)	Byte 1 (Bits 7:0)
Set				
Get	F000Ch			

Field Name	Bits	R/W	Default	Reset
Rsvd2	31:17	R	0000h	N/A (Hard-coded)
	Reserved.			
EapdCap	16	R	1h	N/A (Hard-coded)
	EAPD support: 1 = yes, 0 = no.			

# 92HD81

## SINGLE CHIP PC AUDIO SYSTEM, CODEC+SPEAKER AMPLIFIER+CAPLESS HP+LDO

Field Name	Bits	R/W	Default	Reset
VrefCntrl	15:8	R	00h	N/A (Hard-coded)
	Vref support: bit 7 = Reserved bit 6 = Reserved bit 5 = 100% support (1 = yes, 0 = no) bit 4 = 80% support (1 = yes, 0 = no) bit 3 = Reserved bit 2 = GND support (1 = yes, 0 = no) bit 1 = 50% support (1 = yes, 0 = no) bit 0 = Hi-Z support (1 = yes, 0 = no)			
Rsvd1	7	R	0h	N/A (Hard-coded)
	Reserved.			
BalancedIO	6	R	0h	N/A (Hard-coded)
	Balanced I/O support: 1 = yes, 0 = no.			
InCap	5	R	1h	N/A (Hard-coded)
	Input support: 1 = yes, 0 = no.			
OutCap	4	R	1h	N/A (Hard-coded)
	Output support: 1 = yes, 0 = no.			
HdphDrvCap	3	R	0h	N/A (Hard-coded)
	Headphone amp present: 1 = yes, 0 = no.			
PresDtctCap	2	R	1h	N/A (Hard-coded)
	Presence detection support: 1 = yes, 0 = no.			
TrigRqd	1	R	0h	N/A (Hard-coded)
	Trigger required for impedance sense: 1 = yes, 0 = no.			
ImpSenseCap	0	R	0h	N/A (Hard-coded)
	Impedance sense support: 1 = yes, 0 = no.			

### 7.9.2. PortE (NID = 0Eh): ConLst

Reg	Byte 4 (Bits 31:24)	Byte 3 (Bits 23:16)	Byte 2 (Bits 15:8)	Byte 1 (Bits 7:0)
Set				
Get	F000Eh			

Field Name	Bits	R/W	Default	Reset
Rsvd	31:8	R	000000h	N/A (Hard-coded)
	Reserved.			
LForm	7	R	0h	N/A (Hard-coded)
	Connection list format: 1 = long-form (15-bit) NID entries, 0 = short-form (7-bit) NID entries.			
ConL	6:0	R	03h	N/A (Hard-coded)
	Number of NID entries in connection list.			

### 7.9.3. PortE (NID = 0Eh): ConLstEntry0

Reg	Byte 4 (Bits 31:24)	Byte 3 (Bits 23:16)	Byte 2 (Bits 15:8)	Byte 1 (Bits 7:0)
Set				
Get	F0200h			

Field Name	Bits	R/W	Default	Reset
ConL3	31:24	R	00h	N/A (Hard-coded)
	DAC2 Converter widget (0x22)			
ConL2	23:16	R	1Ch	N/A (Hard-coded)
	MixerOutVol Selector widget (0x1C)			
ConL1	15:8	R	14h	N/A (Hard-coded)
	DAC1 Converter widget (0x14)			
ConL0	7:0	R	13h	N/A (Hard-coded)
	DAC0 Converter widget (0x13)			

### 7.9.4. PortE (NID = 0Eh): InAmpLeft

Reg	Byte 4 (Bits 31:24)	Byte 3 (Bits 23:16)	Byte 2 (Bits 15:8)	Byte 1 (Bits 7:0)
Set				360h
Get	B2000h			

Field Name	Bits	R/W	Default	Reset
Rsvd1	31:2	R	00000000h	N/A (Hard-coded)
	Reserved.			
Gain	1:0	RW	0h	POR - DAFG - ULR
	Amp gain step number (see InAmpCap parameter pertaining to this widget).			

### 7.9.5. PortE (NID = 0Eh): InAmpRight

Reg	Byte 4 (Bits 31:24)	Byte 3 (Bits 23:16)	Byte 2 (Bits 15:8)	Byte 1 (Bits 7:0)
Set				350h
Get	B0000h			

Field Name	Bits	R/W	Default	Reset
Rsvd1	31:2	R	00000000h	N/A (Hard-coded)
	Reserved.			
Gain	1:0	RW	0h	POR - DAFG - ULR
	Amp gain step number (see InAmpCap parameter pertaining to this widget).			

### 7.9.6. PortE (NID = 0Eh): ConSelectCtrl

Reg	Byte 4 (Bits 31:24)	Byte 3 (Bits 23:16)	Byte 2 (Bits 15:8)	Byte 1 (Bits 7:0)
Set				701h
Get	F0100h			

Field Name	Bits	R/W	Default	Reset
Rsvd	31:2	R	00000000h	N/A (Hard-coded)
	Reserved.			
Index	1:0	RW	0h	POR - DAFG - ULR
	Connection select control index.			



**7.9.7. PortE (NID = 0Eh): PwrState**

Reg	Byte 4 (Bits 31:24)	Byte 3 (Bits 23:16)	Byte 2 (Bits 15:8)	Byte 1 (Bits 7:0)
Set				705h
Get	F0500h			

Field Name	Bits	R/W	Default	Reset
Rsvd4	31:11	R	000000h	N/A (Hard-coded)
	Reserved.			
SettingsReset	10	R	1h	POR - DAFG - ULR
	Indicates if any persistent settings in this Widget have been reset. Cleared by PwrState 'Get', or a 'Set' to any Verb in this Widget.			
Rsvd3	9	R	0h	N/A (Hard-coded)
	Reserved.			
Error	8	R	0h	POR - DAFG - ULR
	Error indicator: 1 = cannot enter requested power state, 0 = no problem with requested power state.			
Rsvd2	7:6	R	0h	N/A (Hard-coded)
	Reserved.			
Act	5:4	R	3h	POR - DAFG - LR
	Actual power state of this widget.			
Rsvd1	3:2	R	0h	N/A (Hard-coded)
	Reserved.			
Set	1:0	RW	0h	POR - DAFG - LR
	Current power state setting for this widget.			

**7.9.8. PortE (NID = 0Eh): PinWCntrl**

Reg	Byte 4 (Bits 31:24)	Byte 3 (Bits 23:16)	Byte 2 (Bits 15:8)	Byte 1 (Bits 7:0)
Set				707h
Get	F0700h			

Field Name	Bits	R/W	Default	Reset
Rsvd2	31:7	R	000000h	N/A (Hard-coded)
	Reserved.			
OutEn	6	RW	0h	POR - DAFG - ULR
	Output enable: 1 = enabled, 0 = disabled.			
InEn	5	RW	0h	POR - DAFG - ULR
	Input enable: 1 = enabled, 0 = disabled.			
Rsvd1	4:0	R	0h	N/A (Hard-coded)
	Reserved.			

### 7.9.9. PortE (NID = 0Eh): UnsolResp

Reg	Byte 4 (Bits 31:24)	Byte 3 (Bits 23:16)	Byte 2 (Bits 15:8)	Byte 1 (Bits 7:0)
Set				708h
Get	F0800h			

Field Name	Bits	R/W	Default	Reset
Rsvd2	31:8	R	000000h	N/A (Hard-coded)
	Reserved.			
En	7	RW	0h	POR - DAFG - ULR
	Unsolicited response enable (also enables Wake events for this Widget): 1 = enabled, 0 = disabled.			
Rsvd1	6	R	0h	N/A (Hard-coded)
	Reserved.			
Tag	5:0	RW	00h	POR - DAFG - ULR
	Software programmable field returned in top six bits (31:26) of every Unsolicited Response generated by this node.			

### 7.9.10. PortE (NID = 0Eh): ChSense

Reg	Byte 4 (Bits 31:24)	Byte 3 (Bits 23:16)	Byte 2 (Bits 15:8)	Byte 1 (Bits 7:0)
Set				709h

**7.9.10. PortE (NID = 0Eh): ChSense**

Reg	Byte 4 (Bits 31:24)	Byte 3 (Bits 23:16)	Byte 2 (Bits 15:8)	Byte 1 (Bits 7:0)
Get	F0900h			

Field Name	Bits	R/W	Default	Reset
PresDtct	31	R	0h	POR
Presence detection indicator: 1 = presence detected; 0 = presence not detected.				
Rsvd	30:0	R	00000000h	N/A (Hard-coded)
Reserved.				

**7.9.11. PortE (NID = 0Eh): EAPDBTLLR**

Reg	Byte 4 (Bits 31:24)	Byte 3 (Bits 23:16)	Byte 2 (Bits 15:8)	Byte 1 (Bits 7:0)
Set				70Ch
Get	F0C00h			

Field Name	Bits	R/W	Default	Reset
Rsvd2	31:2	R	00000000h	N/A (Hard-coded)
Reserved.				
EAPD	1	RW	1h	POR - DAFG - ULR
EAPD control: 1 = set EAPD pin to 1 (powered) up if this pin is powered up, 0 = set EAPD pin to 0.				
Rsvd1	0	R	0h	N/A (Hard-coded)
Reserved.				

**7.9.12. PortE (NID = 0Eh): ConfigDefault**

Reg	Byte 4 (Bits 31:24)	Byte 3 (Bits 23:16)	Byte 2 (Bits 15:8)	Byte 1 (Bits 7:0)
Set	71Fh	71Eh	71Dh	71Ch
Get	F1F00h / F1E00h / F1D00h / F1C00h			

**92HD81**

**SINGLE CHIP PC AUDIO SYSTEM, CODEC+SPEAKER AMPLIFIER+CAPLESS HP+LDO**

Field Name	Bits	R/W	Default	Reset
PortConnectivity	31:30	RW	0h	POR
Port connectivity: 0h = Port complex is connected to a jack 1h = No physical connection for port 2h = Fixed function device is attached 3h = Both jack and internal device attached (info in all other fields refers to integrated device, any presence detection refers to jack)				
Location	29:24	RW	01h	POR
Location  Bits [5..4]: 0h = External on primary chassis 1h = Internal 2h = Separate chassis 3h = Other  Bits [3..0]: 0h = N/A 1h = Rear 2h = Front 3h = Left 4h = Right 5h = Top 6h = Bottom 7h-9h = Special Ah-Fh = Reserved				
Device	23:20	RW	8h 0h (YB rev & prior)	POR
Default device: 0h = Line out 1h = Speaker 2h = HP out 3h = CD 4h = SPDIF Out 5h = Digital other out 6h = Modem line side 7h = Modem handset side 8h = Line in 9h = Aux Ah = Mic in Bh = Telephony Ch = SPDIF In Dh = Digital other in Eh = Reserved Fh = Other				

# 92HD81

## SINGLE CHIP PC AUDIO SYSTEM, CODEC+SPEAKER AMPLIFIER+CAPLESS HP+LDO

Field Name	Bits	R/W	Default	Reset
ConnectionType	19:16	RW	1h	POR
	Connection type: 0h = Unknown 1h = 1/8" stereo/mono 2h = 1/4" stereo/mono 3h = ATAPI internal 4h = RCA 5h = Optical 6h = Other digital 7h = Other analog 8h = Multichannel analog (DIN) 9h = XLR/Professional Ah = RJ-11 (modem) Bh = Combination Ch-Eh = Reserved Fh = Other			
Color	15:12	RW	4h	POR
	Color: 0h = Unknown 1h = Black 2h = Grey 3h = Blue 4h = Green 5h = Red 6h = Orange 7h = Yellow 8h = Purple 9h = Pink Ah-Dh = Reserved Eh = White Fh = Other			
Misc	11:8	RW	0h	POR
	Miscellaneous: Bits [3..1] = Reserved Bit 0 = Jack detect override			
Association	7:4	RW	4h 5h (YB rev & prior)	POR
	Default association.			
Sequence	3:0	RW	1h 0h (YB rev & prior)	POR
	Sequence.			

## 7.10. PortF (NID = 0Fh): WCap

Reg	Byte 4 (Bits 31:24)	Byte 3 (Bits 23:16)	Byte 2 (Bits 15:8)	Byte 1 (Bits 7:0)
Set				
Get	F0009h			

Field Name	Bits	R/W	Default	Reset
Rsvd2	31:24	R	00h	N/A (Hard-coded)
	Reserved.			
Type	23:20	R	4h	N/A (Hard-coded)
	Widget type: 0h = Out Converter 1h = In Converter 2h = Summing (Mixer) 3h = Selector (Mux) 4h = Pin Complex 5h = Power 6h = Volume Knob 7h = Beep Generator 8h-Eh = Reserved Fh = Vendor Defined			
Delay	19:16	R	0h	N/A (Hard-coded)
	Number of sample delays through widget.			
Rsvd1	15:12	R	0h	N/A (Hard-coded)
	Reserved.			
SwapCap	11	R	0h	N/A (Hard-coded)
	Left/right swap support: 1 = yes, 0 = no.			
PwrCntrl	10	R	1h	N/A (Hard-coded)
	Power state support: 1 = yes, 0 = no.			
Dig	9	R	0h	N/A (Hard-coded)
	Digital stream support: 1 = yes (digital), 0 = no (analog).			
ConnList	8	R	1h	N/A (Hard-coded)
	Connection list present: 1 = yes, 0 = no.			
UnSolCap	7	R	1h	N/A (Hard-coded)
	Unsolicited response support: 1 = yes, 0 = no.			

## 92HD81

### SINGLE CHIP PC AUDIO SYSTEM, CODEC+SPEAKER AMPLIFIER+CAPLESS HP+LDO

Field Name	Bits	R/W	Default	Reset
ProcWidget	6	R	0h	N/A (Hard-coded)
	Processing state support: 1 = yes, 0 = no.			
Stripe	5	R	0h	N/A (Hard-coded)
	Striping support: 1 = yes, 0 = no.			
FormatOvr	4	R	0h	N/A (Hard-coded)
	Stream format override: 1 = yes, 0 = no.			
AmpParOvr	3	R	0h	N/A (Hard-coded)
	Amplifier capabilities override: 1 = yes, no.			
OutAmpPrsnt	2	R	0h	N/A (Hard-coded)
	Output amp present: 1 = yes, 0 = no.			
InAmpPrsnt	1	R	1h	N/A (Hard-coded)
	Input amp present: 1 = yes, 0 = no.			
Stereo	0	R	1h	N/A (Hard-coded)
	Stereo stream support: 1 = yes (stereo), 0 = no (mono).			

#### 7.10.1. PortF (NID = 0Fh): PinCap

Reg	Byte 4 (Bits 31:24)	Byte 3 (Bits 23:16)	Byte 2 (Bits 15:8)	Byte 1 (Bits 7:0)
Set				
Get	F000Ch			

Field Name	Bits	R/W	Default	Reset
Rsvd2	31:17	R	0000h	N/A (Hard-coded)
	Reserved.			
EapdCap	16	R	1h	N/A (Hard-coded)
	EAPD support: 1 = yes, 0 = no.			

# 92HD81

## SINGLE CHIP PC AUDIO SYSTEM, CODEC+SPEAKER AMPLIFIER+CAPLESS HP+LDO

Field Name	Bits	R/W	Default	Reset
VrefCntrl	15:8	R	00h	N/A (Hard-coded)
	Vref support: bit 7 = Reserved bit 6 = Reserved bit 5 = 100% support (1 = yes, 0 = no) bit 4 = 80% support (1 = yes, 0 = no) bit 3 = Reserved bit 2 = GND support (1 = yes, 0 = no) bit 1 = 50% support (1 = yes, 0 = no) bit 0 = Hi-Z support (1 = yes, 0 = no)			
Rsvd1	7	R	0h	N/A (Hard-coded)
	Reserved.			
BalancedIO	6	R	0h	N/A (Hard-coded)
	Balanced I/O support: 1 = yes, 0 = no.			
InCap	5	R	1h	N/A (Hard-coded)
	Input support: 1 = yes, 0 = no.			
OutCap	4	R	1h	N/A (Hard-coded)
	Output support: 1 = yes, 0 = no.			
HdphDrvCap	3	R	0h	N/A (Hard-coded)
	Headphone amp present: 1 = yes, 0 = no.			
PresDtctCap	2	R	1h	N/A (Hard-coded)
	Presence detection support: 1 = yes, 0 = no.			
TrigRqd	1	R	0h	N/A (Hard-coded)
	Trigger required for impedance sense: 1 = yes, 0 = no.			
ImpSenseCap	0	R	0h	N/A (Hard-coded)
	Impedance sense support: 1 = yes, 0 = no.			

### 7.10.2. PortF (NID = 0Fh): ConLst

Reg	Byte 4 (Bits 31:24)	Byte 3 (Bits 23:16)	Byte 2 (Bits 15:8)	Byte 1 (Bits 7:0)
Set				
Get	F000Eh			



Field Name	Bits	R/W	Default	Reset
Rsvd	31:8	R	000000h	N/A (Hard-coded)
	Reserved.			
LForm	7	R	0h	N/A (Hard-coded)
	Connection list format: 1 = long-form (15-bit) NID entries, 0 = short-form (7-bit) NID entries.			
ConL	6:0	R	03h	N/A (Hard-coded)
	Number of NID entries in connection list.			

### 7.10.3. PortF (NID = 0Fh): ConLstEntry0

Reg	Byte 4 (Bits 31:24)	Byte 3 (Bits 23:16)	Byte 2 (Bits 15:8)	Byte 1 (Bits 7:0)
Set				
Get	F0200h			

Field Name	Bits	R/W	Default	Reset
ConL3	31:24	R	00h	N/A (Hard-coded)
	DAC2 Converter widget (0x22)			
ConL2	23:16	R	1Ch	N/A (Hard-coded)
	MixerOutVol Selector widget (0x1C)			
ConL1	15:8	R	14h	N/A (Hard-coded)
	DAC1 Converter widget (0x14)			
ConL0	7:0	R	13h	N/A (Hard-coded)
	DAC0 Converter widget (0x13)			

### 7.10.4. PortF (NID = 0Fh): InAmpLeft

Reg	Byte 4 (Bits 31:24)	Byte 3 (Bits 23:16)	Byte 2 (Bits 15:8)	Byte 1 (Bits 7:0)
Set				360h
Get	B2000h			

Field Name	Bits	R/W	Default	Reset
Rsvd1	31:2	R	00000000h	N/A (Hard-coded)
	Reserved.			
Gain	1:0	RW	0h	POR - DAFG - ULR
	Amp gain step number (see InAmpCap parameter pertaining to this widget).			

#### 7.10.5. PortF (NID = 0Fh): InAmpRight

Reg	Byte 4 (Bits 31:24)	Byte 3 (Bits 23:16)	Byte 2 (Bits 15:8)	Byte 1 (Bits 7:0)
Set				350h
Get	B0000h			

Field Name	Bits	R/W	Default	Reset
Rsvd1	31:2	R	00000000h	N/A (Hard-coded)
	Reserved.			
Gain	1:0	RW	0h	POR - DAFG - ULR
	Amp gain step number (see InAmpCap parameter pertaining to this widget).			

#### 7.10.6. PortF (NID = 0Fh): ConSelectCtrl

Reg	Byte 4 (Bits 31:24)	Byte 3 (Bits 23:16)	Byte 2 (Bits 15:8)	Byte 1 (Bits 7:0)
Set				701h
Get	F0100h			

Field Name	Bits	R/W	Default	Reset
Rsvd	31:2	R	00000000h	N/A (Hard-coded)
	Reserved.			
Index	1:0	RW	0h	POR - DAFG - ULR
	Connection select control index.			

**7.10.7. PortF (NID = 0Fh): PwrState**

Reg	Byte 4 (Bits 31:24)	Byte 3 (Bits 23:16)	Byte 2 (Bits 15:8)	Byte 1 (Bits 7:0)
Set				705h
Get	F0500h			

Field Name	Bits	R/W	Default	Reset
Rsvd4	31:11	R	000000h	N/A (Hard-coded)
	Reserved.			
SettingsReset	10	R	1h	POR - DAFG - ULR
	Indicates if any persistent settings in this Widget have been reset. Cleared by PwrState 'Get', or a 'Set' to any Verb in this Widget.			
Rsvd3	9	R	0h	N/A (Hard-coded)
	Reserved.			
Error	8	R	0h	POR - DAFG - ULR
	Error indicator: 1 = cannot enter requested power state, 0 = no problem with requested power state.			
Rsvd2	7:6	R	0h	N/A (Hard-coded)
	Reserved.			
Act	5:4	R	3h	POR - DAFG - LR
	Actual power state of this widget.			
Rsvd1	3:2	R	0h	N/A (Hard-coded)
	Reserved.			
Set	1:0	RW	0h	POR - DAFG - LR
	Current power state setting for this widget.			

**7.10.8. PortF (NID = 0Fh): PinWCntrl**

Reg	Byte 4 (Bits 31:24)	Byte 3 (Bits 23:16)	Byte 2 (Bits 15:8)	Byte 1 (Bits 7:0)
Set				707h
Get	F0700h			

Field Name	Bits	R/W	Default	Reset
Rsvd2	31:7	R	000000h	N/A (Hard-coded)
	Reserved.			
OutEn	6	RW	0h	POR - DAFG - ULR
	Output enable: 1 = enabled, 0 = disabled.			
InEn	5	RW	0h	POR - DAFG - ULR
	Input enable: 1 = enabled, 0 = disabled.			
Rsvd1	4:3	R	0h	N/A (Hard-coded)
	Reserved.			
VRefEn	2:0	RW	0h	POR - DAFG - ULR
	Vref selection (See VrefCntrl field of PinCap parameter for supported selections): 000b= HI-Z 001b= 50% 010b= GND 011b= Reserved 100b= 80% 101b= 100% 110b= Reserved 111b= Reserved			

### 7.10.9. PortF (NID = 0Fh): UnsolResp

Reg	Byte 4 (Bits 31:24)	Byte 3 (Bits 23:16)	Byte 2 (Bits 15:8)	Byte 1 (Bits 7:0)
Set				708h
Get	F0800h			

Field Name	Bits	R/W	Default	Reset
Rsvd2	31:8	R	000000h	N/A (Hard-coded)
	Reserved.			
En	7	RW	0h	POR - DAFG - ULR
	Unsolicited response enable (also enables Wake events for this Widget): 1 = enabled, 0 = disabled.			

Field Name	Bits	R/W	Default	Reset
Rsvd1	6	R	0h	N/A (Hard-coded)
	Reserved.			
Tag	5:0	RW	00h	POR - DAFG - ULR
	Software programmable field returned in top six bits (31:26) of every Unsolicited Response generated by this node.			

**7.10.10. PortF (NID = 0Fh): ChSense**

Reg	Byte 4 (Bits 31:24)	Byte 3 (Bits 23:16)	Byte 2 (Bits 15:8)	Byte 1 (Bits 7:0)
Set				709h
Get	F0900h			

Field Name	Bits	R/W	Default	Reset
PresDtct	31	R	0h	POR
	Presence detection indicator: 1 = presence detected; 0 = presence not detected.			
Rsvd	30:0	R	00000000h	N/A (Hard-coded)
	Reserved.			

**7.10.11. PortF (NID = 0Fh): EAPDBTLR**

Reg	Byte 4 (Bits 31:24)	Byte 3 (Bits 23:16)	Byte 2 (Bits 15:8)	Byte 1 (Bits 7:0)
Set				70Ch
Get	F0C00h			

Field Name	Bits	R/W	Default	Reset
Rsvd2	31:2	R	00000000h	N/A (Hard-coded)
	Reserved.			
EAPD	1	RW	1h	POR - DAFG - ULR
	EAPD control: 1 = set EAPD pin to 1 (powered) up if this pin is powered up, 0 = set EAPD pin to 0.			

Field Name	Bits	R/W	Default	Reset
Rsvd1	0	R	0h	N/A (Hard-coded)
Reserved.				

**7.10.12. PortF (NID = 0Fh): ConfigDefault**

Reg	Byte 4 (Bits 31:24)	Byte 3 (Bits 23:16)	Byte 2 (Bits 15:8)	Byte 1 (Bits 7:0)
Set	71Fh	71Eh	71Dh	71Ch
Get	F1F00h / F1E00h / F1D00h / F1C00h			

Field Name	Bits	R/W	Default	Reset
PortConnectivity	31:30	RW	0h	POR
Port connectivity: 0h = Port complex is connected to a jack 1h = No physical connection for port 2h = Fixed function device is attached 3h = Both jack and internal device attached (info in all other fields refers to integrated device, any presence detection refers to jack)				
Location	29:24	RW	01h	POR
Location  Bits [5..4]: 0h = External on primary chassis 1h = Internal 2h = Separate chassis 3h = Other  Bits [3..0]: 0h = N/A 1h = Rear 2h = Front 3h = Left 4h = Right 5h = Top 6h = Bottom 7h-9h = Special Ah-Fh = Reserved				

**92HD81****SINGLE CHIP PC AUDIO SYSTEM, CODEC+SPEAKER AMPLIFIER+CAPLESS HP+LDO**

Field Name	Bits	R/W	Default	Reset
Device	23:20	RW	8h	POR
Default device: 0h = Line out 1h = Speaker 2h = HP out 3h = CD 4h = SPDIF Out 5h = Digital other out 6h = Modem line side 7h = Modem handset side 8h = Line in 9h = Aux Ah = Mic in Bh = Telephony Ch = SPDIF In Dh = Digital other in Eh = Reserved Fh = Other				
ConnectionType	19:16	RW	1h	POR
Connection type: 0h = Unknown 1h = 1/8" stereo/mono 2h = 1/4" stereo/mono 3h = ATAPI internal 4h = RCA 5h = Optical 6h = Other digital 7h = Other analog 8h = Multichannel analog (DIN) 9h = XLR/Professional Ah = RJ-11 (modem) Bh = Combination Ch-Eh = Reserved Fh = Other				

# 92HD81

## SINGLE CHIP PC AUDIO SYSTEM, CODEC+SPEAKER AMPLIFIER+CAPLESS HP+LDO

Field Name	Bits	R/W	Default	Reset
Color	15:12	RW	9h	POR
	Color: 0h = Unknown 1h = Black 2h = Grey 3h = Blue 4h = Green 5h = Red 6h = Orange 7h = Yellow 8h = Purple 9h = Pink Ah-Dh = Reserved Eh = White Fh = Other			
Misc	11:8	RW	0h	POR
	Miscellaneous: Bits [3..1] = Reserved Bit 0 = Jack detect override			
Association	7:4	RW	4h	POR
	Default association.			
Sequence	3:0	RW	0h	POR
	Sequence.			



## 7.11. MonoOut (NID = 10h): WCap

Reg	Byte 4 (Bits 31:24)	Byte 3 (Bits 23:16)	Byte 2 (Bits 15:8)	Byte 1 (Bits 7:0)
Set				
Get	F0009h			

Field Name	Bits	R/W	Default	Reset
Rsvd2	31:24	R	00h	N/A (Hard-coded)
	Reserved.			
Type	23:20	R	4h	N/A (Hard-coded)
	Widget type: 0h = Out Converter 1h = In Converter 2h = Summing (Mixer) 3h = Selector (Mux) 4h = Pin Complex 5h = Power 6h = Volume Knob 7h = Beep Generator 8h-Eh = Reserved Fh = Vendor Defined			
Delay	19:16	R	0h	N/A (Hard-coded)
	Number of sample delays through widget.			
Rsvd1	15:12	R	0h	N/A (Hard-coded)
	Reserved.			
SwapCap	11	R	0h	N/A (Hard-coded)
	Left/right swap support: 1 = yes, 0 = no.			
PwrCntrl	10	R	1h	N/A (Hard-coded)
	Power state support: 1 = yes, 0 = no.			
Dig	9	R	0h	N/A (Hard-coded)
	Digital stream support: 1 = yes (digital), 0 = no (analog).			
ConnList	8	R	1h	N/A (Hard-coded)
	Connection list present: 1 = yes, 0 = no.			
UnSolCap	7	R	0h	N/A (Hard-coded)
	Unsolicited response support: 1 = yes, 0 = no.			

Field Name	Bits	R/W	Default	Reset
ProcWidget	6	R	0h	N/A (Hard-coded)
	Processing state support: 1 = yes, 0 = no.			
Stripe	5	R	0h	N/A (Hard-coded)
	Striping support: 1 = yes, 0 = no.			
FormatOvr	4	R	0h	N/A (Hard-coded)
	Stream format override: 1 = yes, 0 = no.			
AmpParOvr	3	R	0h	N/A (Hard-coded)
	Amplifier capabilities override: 1 = yes, no.			
OutAmpPrsnt	2	R	0h	N/A (Hard-coded)
	Output amp present: 1 = yes, 0 = no.			
InAmpPrsnt	1	R	0h	N/A (Hard-coded)
	Input amp present: 1 = yes, 0 = no.			
Stereo	0	R	0h	N/A (Hard-coded)
	Stereo stream support: 1 = yes (stereo), 0 = no (mono).			

### 7.11.1. MonoOut (NID = 10h): PinCap

Reg	Byte 4 (Bits 31:24)	Byte 3 (Bits 23:16)	Byte 2 (Bits 15:8)	Byte 1 (Bits 7:0)
Set				
Get	F000Ch			

Field Name	Bits	R/W	Default	Reset
Rsvd2	31:17	R	0000h	N/A (Hard-coded)
	Reserved.			
EapdCap	16	R	0h	N/A (Hard-coded)
	EAPD support: 1 = yes, 0 = no.			

Field Name	Bits	R/W	Default	Reset
VrefCntrl	15:8	R	00h	N/A (Hard-coded)
	Vref support: bit 7 = Reserved bit 6 = Reserved bit 5 = 100% support (1 = yes, 0 = no) bit 4 = 80% support (1 = yes, 0 = no) bit 3 = Reserved bit 2 = GND support (1 = yes, 0 = no) bit 1 = 50% support (1 = yes, 0 = no) bit 0 = Hi-Z support (1 = yes, 0 = no)			
Rsvd1	7	R	0h	N/A (Hard-coded)
	Reserved.			
BalancedIO	6	R	0h	N/A (Hard-coded)
	Balanced I/O support: 1 = yes, 0 = no.			
InCap	5	R	0h	N/A (Hard-coded)
	Input support: 1 = yes, 0 = no.			
OutCap	4	R	1h	N/A (Hard-coded)
	Output support: 1 = yes, 0 = no.			
HdphDrvCap	3	R	0h	N/A (Hard-coded)
	Headphone amp present: 1 = yes, 0 = no.			
PresDtctCap	2	R	0h	N/A (Hard-coded)
	Presence detection support: 1 = yes, 0 = no.			
TrigRqd	1	R	0h	N/A (Hard-coded)
	Trigger required for impedance sense: 1 = yes, 0 = no.			
ImpSenseCap	0	R	0h	N/A (Hard-coded)
	Impedance sense support: 1 = yes, 0 = no.			

### 7.11.2. MonoOut (NID = 10h): ConLst

Reg	Byte 4 (Bits 31:24)	Byte 3 (Bits 23:16)	Byte 2 (Bits 15:8)	Byte 1 (Bits 7:0)
Set				
Get	F000Eh			

Field Name	Bits	R/W	Default	Reset
Rsvd	31:8	R	000000h	N/A (Hard-coded)
	Reserved.			
LForm	7	R	0h	N/A (Hard-coded)
	Connection list format: 1 = long-form (15-bit) NID entries, 0 = short-form (7-bit) NID entries.			
ConL	6:0	R	01h	N/A (Hard-coded)
	Number of NID entries in connection list.			

**7.11.3. MonoOut (NID = 10h): ConLstEntry0**

Reg	Byte 4 (Bits 31:24)	Byte 3 (Bits 23:16)	Byte 2 (Bits 15:8)	Byte 1 (Bits 7:0)
Set				
Get	F0200h			

Field Name	Bits	R/W	Default	Reset
ConL3	31:24	R	00h	N/A (Hard-coded)
	Unused list entry.			
ConL2	23:16	R	00h	N/A (Hard-coded)
	Unused list entry.			
ConL1	15:8	R	00h	N/A (Hard-coded)
	Unused list entry.			
ConL0	7:0	R	1Ah	N/A (Hard-coded)
	MonoMix Summing widget (0x1A)			

**7.11.4. MonoOut (NID = 10h): PwrState**

Reg	Byte 4 (Bits 31:24)	Byte 3 (Bits 23:16)	Byte 2 (Bits 15:8)	Byte 1 (Bits 7:0)
Set				705h
Get	F0500h			

Field Name	Bits	R/W	Default	Reset
Rsvd4	31:11	R	000000h	N/A (Hard-coded)
	Reserved.			
SettingsReset	10	R	1h	POR - DAFG - ULR
	Indicates if any persistent settings in this Widget have been reset. Cleared by PwrState 'Get', or a 'Set' to any Verb in this Widget.			
Rsvd3	9	R	0h	N/A (Hard-coded)
	Reserved.			
Error	8	R	0h	POR - DAFG - ULR
	Error indicator: 1 = cannot enter requested power state, 0 = no problem with requested power state.			
Rsvd2	7:6	R	0h	N/A (Hard-coded)
	Reserved.			
Act	5:4	R	3h	POR - DAFG - LR
	Actual power state of this widget.			
Rsvd1	3:2	R	0h	N/A (Hard-coded)
	Reserved.			
Set	1:0	RW	0h	POR - DAFG - LR
	Current power state setting for this widget.			

#### 7.11.5. MonoOut (NID = 10h): PinWCntrl

Reg	Byte 4 (Bits 31:24)	Byte 3 (Bits 23:16)	Byte 2 (Bits 15:8)	Byte 1 (Bits 7:0)
Set				707h
Get	F0700h			

Field Name	Bits	R/W	Default	Reset
Rsvd2	31:7	R	000000h	N/A (Hard-coded)
	Reserved.			
OutEn	6	RW	0h	POR - DAFG - ULR
	Output enable: 1 = enabled, 0 = disabled.			

Field Name	Bits	R/W	Default	Reset
Rsvd1	5:0	R	0h	N/A (Hard-coded)
Reserved.				

**7.11.6. MonoOut (NID = 10h): ConfigDefault**

Reg	Byte 4 (Bits 31:24)	Byte 3 (Bits 23:16)	Byte 2 (Bits 15:8)	Byte 1 (Bits 7:0)
Set	71Fh	71Eh	71Dh	71Ch
Get	F1F00h / F1E00h / F1D00h / F1C00h			

Field Name	Bits	R/W	Default	Reset
PortConnectivity	31:30	RW	1h	POR
Port connectivity: 0h = Port complex is connected to a jack 1h = No physical connection for port 2h = Fixed function device is attached 3h = Both jack and internal device attached (info in all other fields refers to integrated device, any presence detection refers to jack)				
Location	29:24	RW	00h	POR
Location  Bits [5..4]: 0h = External on primary chassis 1h = Internal 2h = Separate chassis 3h = Other  Bits [3..0]: 0h = N/A 1h = Rear 2h = Front 3h = Left 4h = Right 5h = Top 6h = Bottom 7h-9h = Special Ah-Fh = Reserved				

**92HD81****SINGLE CHIP PC AUDIO SYSTEM, CODEC+SPEAKER AMPLIFIER+CAPLESS HP+LDO**

Field Name	Bits	R/W	Default	Reset
Device	23:20	RW	Fh	POR
Default device: 0h = Line out 1h = Speaker 2h = HP out 3h = CD 4h = SPDIF Out 5h = Digital other out 6h = Modem line side 7h = Modem handset side 8h = Line in 9h = Aux Ah = Mic in Bh = Telephony Ch = SPDIF In Dh = Digital other in Eh = Reserved Fh = Other				
ConnectionType	19:16	RW	0h	POR
Connection type: 0h = Unknown 1h = 1/8" stereo/mono 2h = 1/4" stereo/mono 3h = ATAPI internal 4h = RCA 5h = Optical 6h = Other digital 7h = Other analog 8h = Multichannel analog (DIN) 9h = XLR/Professional Ah = RJ-11 (modem) Bh = Combination Ch-Eh = Reserved Fh = Other				

# 92HD81

## SINGLE CHIP PC AUDIO SYSTEM, CODEC+SPEAKER AMPLIFIER+CAPLESS HP+LDO

Field Name	Bits	R/W	Default	Reset
Color	15:12	RW	0h	POR
	Color: 0h = Unknown 1h = Black 2h = Grey 3h = Blue 4h = Green 5h = Red 6h = Orange 7h = Yellow 8h = Purple 9h = Pink Ah-Dh = Reserved Eh = White Fh = Other			
Misc	11:8	RW	0h	POR
	Miscellaneous: Bits [3..1] = Reserved Bit 0 = Jack detect override			
Association	7:4	RW	Fh	POR
	Default association.			
Sequence	3:0	RW	0h	POR
	Sequence.			

### 7.12. DMic0 (NID = 11h): WCap

Reg	Byte 4 (Bits 31:24)	Byte 3 (Bits 23:16)	Byte 2 (Bits 15:8)	Byte 1 (Bits 7:0)
Set				
Get	F0009h			

Field Name	Bits	R/W	Default	Reset
Rsvd2	31:24	R	00h	N/A (Hard-coded)
	Reserved.			



# 92HD81

## SINGLE CHIP PC AUDIO SYSTEM, CODEC+SPEAKER AMPLIFIER+CAPLESS HP+LDO

Field Name	Bits	R/W	Default	Reset
Type	23:20	R	4h	N/A (Hard-coded)
Widget type: 0h = Out Converter 1h = In Converter 2h = Summing (Mixer) 3h = Selector (Mux) 4h = Pin Complex 5h = Power 6h = Volume Knob 7h = Beep Generator 8h-Eh = Reserved Fh = Vendor Defined				
Delay	19:16	R	0h	N/A (Hard-coded)
Number of sample delays through widget.				
Rsvd1	15:12	R	0h	N/A (Hard-coded)
Reserved.				
SwapCap	11	R	0h	N/A (Hard-coded)
Left/right swap support: 1 = yes, 0 = no.				
PwrCntrl	10	R	1h	N/A (Hard-coded)
Power state support: 1 = yes, 0 = no.				
DigitalStrm	9	R	0h	N/A (Hard-coded)
Digital stream support: 1 = yes (digital), 0 = no (analog).				
ConnList	8	R	0h	N/A (Hard-coded)
Connection list present: 1 = yes, 0 = no.				
UnsolCap	7	R	1h	N/A (Hard-coded)
Unsolicited response support: 1 = yes, 0 = no.				
ProcWidget	6	R	0h	N/A (Hard-coded)
Processing state support: 1 = yes, 0 = no.				
Stripe	5	R	0h	N/A (Hard-coded)
Striping support: 1 = yes, 0 = no.				
FormatOvrd	4	R	0h	N/A (Hard-coded)
Stream format override: 1 = yes, 0 = no.				

Field Name	Bits	R/W	Default	Reset
AmpParOvrd	3	R	0h	N/A (Hard-coded)
Amplifier capabilities override: 1 = yes, no.				
OutAmpPrsnt	2	R	0h	N/A (Hard-coded)
Output amp present: 1 = yes, 0 = no.				
InAmpPrsnt	1	R	1h	N/A (Hard-coded)
Input amp present: 1 = yes, 0 = no.				
Stereo	0	R	1h	N/A (Hard-coded)
Stereo stream support: 1 = yes (stereo), 0 = no (mono).				

### 7.12.1. DMic0 (NID = 11h): PinCap

Reg	Byte 4 (Bits 31:24)	Byte 3 (Bits 23:16)	Byte 2 (Bits 15:8)	Byte 1 (Bits 7:0)
Set				
Get	F000Ch			

Field Name	Bits	R/W	Default	Reset
Rsvd2	31:17	R	0000h	N/A (Hard-coded)
Reserved.				
EapdCap	16	R	0h	N/A (Hard-coded)
EAPD support: 1 = yes, 0 = no.				
VRefCntrl	15:8	R	00h	N/A (Hard-coded)
Vref support: bit 7 = Reserved bit 6 = Reserved bit 5 = 100% support (1 = yes, 0 = no) bit 4 = 80% support (1 = yes, 0 = no) bit 3 = Reserved bit 2 = GND support (1 = yes, 0 = no) bit 1 = 50% support (1 = yes, 0 = no) bit 0 = Hi-Z support (1 = yes, 0 = no)				
Rsvd1	7	R	0h	N/A (Hard-coded)
Reserved.				

Field Name	Bits	R/W	Default	Reset
BalancedIO	6	R	0h	N/A (Hard-coded)
Balanced I/O support: 1 = yes, 0 = no.				
InCap	5	R	1h	N/A (Hard-coded)
Input support: 1 = yes, 0 = no.				
OutCap	4	R	0h	N/A (Hard-coded)
Output support: 1 = yes, 0 = no.				
HPhnDrvCap	3	R	0h	N/A (Hard-coded)
Headphone amp present: 1 = yes, 0 = no.				
PresDtctCap	2	R	1h	N/A (Hard-coded)
Presence detection support: 1 = yes, 0 = no.				
TrigRqd	1	R	0h	N/A (Hard-coded)
Trigger required for impedance sense: 1 = yes, 0 = no.				
ImpSenseCap	0	R	0h	N/A (Hard-coded)
Impedance sense support: 1 = yes, 0 = no.				

### 7.12.2. DMic0 (NID = 11h): InAmpLeft

Reg	Byte 4 (Bits 31:24)	Byte 3 (Bits 23:16)	Byte 2 (Bits 15:8)	Byte 1 (Bits 7:0)
Set				360h
Get	B2000h			

Field Name	Bits	R/W	Default	Reset
Rsvd1	31:2	R	00000000h	N/A (Hard-coded)
Reserved.				
Gain	1:0	RW	0h	POR - DAFG - ULR
Amp gain step number (see InAmpCap parameter pertaining to this widget).				

### 7.12.3. DMic0 (NID = 11h): InAmpRight

Reg	Byte 4 (Bits 31:24)	Byte 3 (Bits 23:16)	Byte 2 (Bits 15:8)	Byte 1 (Bits 7:0)
Set				350h

**7.12.3. DMic0 (NID = 11h): InAmpRight**

Reg	Byte 4 (Bits 31:24)	Byte 3 (Bits 23:16)	Byte 2 (Bits 15:8)	Byte 1 (Bits 7:0)
Get	B0000h			

Field Name	Bits	R/W	Default	Reset
Rsvd1	31:2	R	00000000h	N/A (Hard-coded)
	Reserved.			
Gain	1:0	RW	0h	POR - DAFG - ULR
	Amp gain step number (see InAmpCap parameter pertaining to this widget).			

**7.12.4. DMic0 (NID = 11h): PwrState**

Reg	Byte 4 (Bits 31:24)	Byte 3 (Bits 23:16)	Byte 2 (Bits 15:8)	Byte 1 (Bits 7:0)
Set				705h
Get	F0500h			

Field Name	Bits	R/W	Default	Reset
Rsvd4	31:11	R	000000h	N/A (Hard-coded)
	Reserved.			
SettingsReset	10	R	1h	POR - DAFG - ULR
	Indicates if any persistent settings in this Widget have been reset. Cleared by PwrState 'Get', or a 'Set' to any Verb in this Widget.			
Rsvd3	9	R	0h	N/A (Hard-coded)
	Reserved.			
Error	8	R	0h	POR - DAFG - ULR
	Error indicator: 1 = cannot enter requested power state, 0 = no problem with requested power state.			
Rsvd2	7:6	R	0h	N/A (Hard-coded)
	Reserved.			
Act	5:4	R	3h	POR - DAFG - LR
	Actual power state of this widget.			

Field Name	Bits	R/W	Default	Reset
Rsvd1	3:2	R	0h	N/A (Hard-coded)
	Reserved.			
Set	1:0	RW	0h	POR - DAFG - LR
	Current power state setting for this widget.			

#### 7.12.5. DMic0 (NID = 11h): PinWCntrl

Reg	Byte 4 (Bits 31:24)	Byte 3 (Bits 23:16)	Byte 2 (Bits 15:8)	Byte 1 (Bits 7:0)
Set				707h
Get	F0700h			

Field Name	Bits	R/W	Default	Reset
Rsvd2	31:6	R	0000000h	N/A (Hard-coded)
	Reserved.			
InEn	5	RW	0h	POR - DAFG - ULR
	Input enable: 1 = enabled, 0 = disabled.			
Rsvd1	4:0	R	00h	N/A (Hard-coded)
	Reserved.			

#### 7.12.6. DMic0 (NID = 11h): UnsolResp

Reg	Byte 4 (Bits 31:24)	Byte 3 (Bits 23:16)	Byte 2 (Bits 15:8)	Byte 1 (Bits 7:0)
Set				708h
Get	F0800h			

Field Name	Bits	R/W	Default	Reset
Rsvd2	31:8	R	000000h	N/A (Hard-coded)
	Reserved.			
En	7	RW	0h	POR - DAFG - ULR
	Unsolicited response enable (also enables Wake events for this Widget): 1 = enabled, 0 = disabled.			

Field Name	Bits	R/W	Default	Reset
Rsvd1	6	R	0h	N/A (Hard-coded)
	Reserved.			
Tag	5:0	RW	00h	POR - DAFG - ULR
	Software programmable field returned in top six bits (31:26) of every Unsolicited Response generated by this node.			

### 7.12.7. DMic0 (NID = 11h): ChSense

Reg	Byte 4 (Bits 31:24)	Byte 3 (Bits 23:16)	Byte 2 (Bits 15:8)	Byte 1 (Bits 7:0)
Set				709h
Get	F0900h			

Field Name	Bits	R/W	Default	Reset
PresDtct	31	R	0h	POR
	Presence detection indicator: 1 = presence detected; 0 = presence not detected.			
Rsvd	30:0	R	00000000h	N/A (Hard-coded)
	Reserved.			

### 7.12.8. DMic0 (NID = 11h): ConfigDefault

Reg	Byte 4 (Bits 31:24)	Byte 3 (Bits 23:16)	Byte 2 (Bits 15:8)	Byte 1 (Bits 7:0)
Set	71Fh	71Eh	71Dh	71Ch
Get	F1F00h / F1E00h / F1D00h / F1C00h			

Field Name	Bits	R/W	Default	Reset
PortConnectivity	31:30	RW	2h	POR
	Port connectivity: 0h = Port complex is connected to a jack 1h = No physical connection for port 2h = Fixed function device is attached 3h = Both jack and internal device attached (info in all other fields refers to integrated device, any presence detection refers to jack)			

**92HD81****SINGLE CHIP PC AUDIO SYSTEM, CODEC+SPEAKER AMPLIFIER+CAPLESS HP+LDO**

Field Name	Bits	R/W	Default	Reset
Location	29:24	RW	10h	POR
	Location  Bits [5..4]: 0h = External on primary chassis 1h = Internal 2h = Separate chassis 3h = Other  Bits [3..0]: 0h = N/A 1h = Rear 2h = Front 3h = Left 4h = Right 5h = Top 6h = Bottom 7h-9h = Special Ah-Fh = Reserved			
Device	23:20	RW	Ah	POR
	Default device: 0h = Line out 1h = Speaker 2h = HP out 3h = CD 4h = SPDIF Out 5h = Digital other out 6h = Modem line side 7h = Modem handset side 8h = Line in 9h = Aux Ah = Mic in Bh = Telephony Ch = SPDIF In Dh = Digital other in Eh = Reserved Fh = Other			

**92HD81**

**SINGLE CHIP PC AUDIO SYSTEM, CODEC+SPEAKER AMPLIFIER+CAPLESS HP+LDO**

Field Name	Bits	R/W	Default	Reset
ConnectionType	19:16	RW	3h	POR
	Connection type: 0h = Unknown 1h = 1/8" stereo/mono 2h = 1/4" stereo/mono 3h = ATAPI internal 4h = RCA 5h = Optical 6h = Other digital 7h = Other analog 8h = Multichannel analog (DIN) 9h = XLR/Professional Ah = RJ-11 (modem) Bh = Combination Ch-Eh = Reserved Fh = Other			
Color	15:12	RW	0h	POR
	Color: 0h = Unknown 1h = Black 2h = Grey 3h = Blue 4h = Green 5h = Red 6h = Orange 7h = Yellow 8h = Purple 9h = Pink Ah-Dh = Reserved Eh = White Fh = Other			
Misc	11:8	RW	1h	POR
	Miscellaneous: Bits [3..1] = Reserved Bit 0 = Jack detect override			
Association	7:4	RW	4h	POR
	Default association.			
Sequence	3:0	RW	Eh	POR
	Sequence.			



## 7.13. DMic1Vol (NID = 12h): WCap

Reg	Byte 4 (Bits 31:24)	Byte 3 (Bits 23:16)	Byte 2 (Bits 15:8)	Byte 1 (Bits 7:0)
Set				
Get	F0009h			

Field Name	Bits	R/W	Default	Reset
Rsvd2	31:24	R	00h	N/A (Hard-coded)
	Reserved.			
Type	23:20	R	Fh	N/A (Hard-coded)
	Widget type: 0h = Out Converter 1h = In Converter 2h = Summing (Mixer) 3h = Selector (Mux) 4h = Pin Complex 5h = Power 6h = Volume Knob 7h = Beep Generator 8h-Eh = Reserved Fh = Vendor Defined			
Delay	19:16	R	0h	N/A (Hard-coded)
	Number of sample delays through widget.			
Rsvd1	15:12	R	0h	N/A (Hard-coded)
	Reserved.			
SwapCap	11	R	0h	N/A (Hard-coded)
	Left/right swap support: 1 = yes, 0 = no.			
PwrCntrl	10	R	1h	N/A (Hard-coded)
	Power state support: 1 = yes, 0 = no.			
DigitalStrm	9	R	0h	N/A (Hard-coded)
	Digital stream support: 1 = yes (digital), 0 = no (analog).			
ConnList	8	R	1h	N/A (Hard-coded)
	Connection list present: 1 = yes, 0 = no.			
UnsolCap	7	R	0h	N/A (Hard-coded)
	Unsolicited response support: 1 = yes, 0 = no.			

Field Name	Bits	R/W	Default	Reset
ProcWidget	6	R	0h	N/A (Hard-coded)
	Processing state support: 1 = yes, 0 = no.			
Stripe	5	R	0h	N/A (Hard-coded)
	Striping support: 1 = yes, 0 = no.			
FormatOvr	4	R	0h	N/A (Hard-coded)
	Stream format override: 1 = yes, 0 = no.			
AmpParOvr	3	R	0h	N/A (Hard-coded)
	Amplifier capabilities override: 1 = yes, no.			
OutAmpPrsnt	2	R	0h	N/A (Hard-coded)
	Output amp present: 1 = yes, 0 = no.			
InAmpPrsnt	1	R	1h	N/A (Hard-coded)
	Input amp present: 1 = yes, 0 = no.			
Stereo	0	R	1h	N/A (Hard-coded)
	Stereo stream support: 1 = yes (stereo), 0 = no (mono).			

### 7.13.1. DMic1Vol (NID = 12h): ConLst

Reg	Byte 4 (Bits 31:24)	Byte 3 (Bits 23:16)	Byte 2 (Bits 15:8)	Byte 1 (Bits 7:0)
Set				
Get	F000Eh			

Field Name	Bits	R/W	Default	Reset
Rsvd	31:8	R	000000h	N/A (Hard-coded)
	Reserved.			
LForm	7	R	0h	N/A (Hard-coded)
	Connection list format: 1 = long-form (15-bit) NID entries, 0 = short-form (7-bit) NID entries.			
ConL	6:0	R	01h	N/A (Hard-coded)
	Number of NID entries in connection list.			

**7.13.2. DMic1Vol (NID = 12h): ConLstEntry0**

Reg	Byte 4 (Bits 31:24)	Byte 3 (Bits 23:16)	Byte 2 (Bits 15:8)	Byte 1 (Bits 7:0)
Set				
Get	F0200h			

Field Name	Bits	R/W	Default	Reset
ConL3	31:24	R	00h	N/A (Hard-coded)
	Unused list entry.			
ConL2	23:16	R	00h	N/A (Hard-coded)
	Unused list entry.			
ConL1	15:8	R	00h	N/A (Hard-coded)
	Unused list entry.			
ConL0	7:0	R	20h	N/A (Hard-coded)
	Dig1Pin Pin widget (0x20)			

**7.13.3. DMic1Vol (NID = 12h): InAmpLeft**

Reg	Byte 4 (Bits 31:24)	Byte 3 (Bits 23:16)	Byte 2 (Bits 15:8)	Byte 1 (Bits 7:0)
Set				360h
Get	B2000h			

Field Name	Bits	R/W	Default	Reset
Rsvd1	31:2	R	00000000h	N/A (Hard-coded)
	Reserved.			
Gain	1:0	RW	0h	POR - DAFG - ULR
	Amp gain step number (see InAmpCap parameter pertaining to this widget).			

**7.13.4. DMic1Vol (NID = 12h): InAmpRight**

Reg	Byte 4 (Bits 31:24)	Byte 3 (Bits 23:16)	Byte 2 (Bits 15:8)	Byte 1 (Bits 7:0)
Set				350h
Get	B0000h			

Field Name	Bits	R/W	Default	Reset
Rsvd1	31:2	R	00000000h	N/A (Hard-coded)
	Reserved.			
Gain	1:0	RW	0h	POR - DAFG - ULR
	Amp gain step number (see InAmpCap parameter pertaining to this widget).			

### 7.13.5. DMic1Vol (NID = 12h): PwrState

Reg	Byte 4 (Bits 31:24)	Byte 3 (Bits 23:16)	Byte 2 (Bits 15:8)	Byte 1 (Bits 7:0)
Set				705h
Get	F0500h			

Field Name	Bits	R/W	Default	Reset
Rsvd4	31:11	R	000000h	N/A (Hard-coded)
	Reserved.			
SettingsReset	10	R	1h	POR - DAFG - ULR
	Indicates if any persistent settings in this Widget have been reset. Cleared by PwrState 'Get', or a 'Set' to any Verb in this Widget.			
Rsvd3	9	R	0h	N/A (Hard-coded)
	Reserved.			
Error	8	R	0h	POR - DAFG - ULR
	Error indicator: 1 = cannot enter requested power state, 0 = no problem with requested power state.			
Rsvd2	7:6	R	0h	N/A (Hard-coded)
	Reserved.			
Act	5:4	R	3h	POR - DAFG - LR
	Actual power state of this widget.			
Rsvd1	3:2	R	0h	N/A (Hard-coded)
	Reserved.			
Set	1:0	RW	0h	POR - DAFG - LR
	Current power state setting for this widget.			

## 7.14. DAC0 (NID = 13h): WCap

Reg	Byte 4 (Bits 31:24)	Byte 3 (Bits 23:16)	Byte 2 (Bits 15:8)	Byte 1 (Bits 7:0)
Set				
Get	F0009h			

Field Name	Bits	R/W	Default	Reset
Rsvd2	31:24	R	00h	N/A (Hard-coded)
	Reserved.			
Type	23:20	R	0h	N/A (Hard-coded)
	Widget type: 0h = Out Converter 1h = In Converter 2h = Summing (Mixer) 3h = Selector (Mux) 4h = Pin Complex 5h = Power 6h = Volume Knob 7h = Beep Generator 8h-Eh = Reserved Fh = Vendor Defined			
Delay	19:16	R	Dh	N/A (Hard-coded)
	Number of sample delays through widget.			
Rsvd1	15:12	R	0h	N/A (Hard-coded)
	Reserved.			
SwapCap	11	R	1h	N/A (Hard-coded)
	Left/right swap support: 1 = yes, 0 = no.			
PwrCntrl	10	R	1h	N/A (Hard-coded)
	Power state support: 1 = yes, 0 = no.			
Dig	9	R	0h	N/A (Hard-coded)
	Digital stream support: 1 = yes (digital), 0 = no (analog).			
ConnList	8	R	0h	N/A (Hard-coded)
	Connection list present: 1 = yes, 0 = no.			
UnSolCap	7	R	0h	N/A (Hard-coded)
	Unsolicited response support: 1 = yes, 0 = no.			

# 92HD81

## SINGLE CHIP PC AUDIO SYSTEM, CODEC+SPEAKER AMPLIFIER+CAPLESS HP+LDO

Field Name	Bits	R/W	Default	Reset
ProcWidget	6	R	0h	N/A (Hard-coded)
	Processing state support: 1 = yes, 0 = no.			
Stripe	5	R	0h	N/A (Hard-coded)
	Striping support: 1 = yes, 0 = no.			
FormatOvr	4	R	0h	N/A (Hard-coded)
	Stream format override: 1 = yes, 0 = no.			
AmpParOvr	3	R	0h	N/A (Hard-coded)
	Amplifier capabilities override: 1 = yes, no.			
OutAmpPrsnt	2	R	1h	N/A (Hard-coded)
	Output amp present: 1 = yes, 0 = no.			
InAmpPrsnt	1	R	0h	N/A (Hard-coded)
	Input amp present: 1 = yes, 0 = no.			
Stereo	0	R	1h	N/A (Hard-coded)
	Stereo stream support: 1 = yes (stereo), 0 = no (mono).			

### 7.14.1. DAC0 (NID = 13h): Cnvtr

Reg	Byte 4 (Bits 31:24)	Byte 3 (Bits 23:16)	Byte 2 (Bits 15:8)	Byte 1 (Bits 7:0)
Set				2h
Get	A0000h			

Field Name	Bits	R/W	Default	Reset
Rsvd2	31:16	R	0000h	N/A (Hard-coded)
	Reserved.			
StrmType	15	R	0h	N/A (Hard-coded)
	Stream type: 1 = Non-PCM, 0 = PCM.			
FrmtSmpIRate	14	RW	0h	POR - DAFG - ULR
	Sample base rate: 1 = 44.1kHz, 0 = 48kHz.			

# 92HD81

## SINGLE CHIP PC AUDIO SYSTEM, CODEC+SPEAKER AMPLIFIER+CAPLESS HP+LDO

Field Name	Bits	R/W	Default	Reset
SmplRateMultp	13:11	RW	0h	POR - DAFG - ULR
	Sample base rate multiple: 000b= x1 (48kHz/44.1kHz or less) 001b= x2 (96kHz/88.2kHz/32kHz) 010b= x3 (144kHz) 011b= x4 (192kHz/176.4kHz) 100b-111b Reserved			
SmplRateDiv	10:8	RW	0h	POR - DAFG - ULR
	Sample base rate divider: 000b= Divide by 1 (48kHz/44.1kHz) 001b= Divide by 2 (24kHz/20.05kHz) 010b= Divide by 3 (16kHz/32kHz) 011b= Divide by 4 (11.025kHz) 100b= Divide by 5 (9.6kHz) 101b= Divide by 6 (8kHz) 110b= Divide by 7 111b= Divide by 8 (6kHz)			
Rsvd1	7	R	0h	N/A (Hard-coded)
	Reserved.			
BitsPerSmpl	6:4	RW	3h	POR - DAFG - ULR
	Bits per sample: 000b= 8 bits 001b= 16 bits 010b= 20 bits 011b= 24 bits 100b= 32 bits 101b-111b= Reserved			
NmbrChan	3:0	RW	1h	POR - DAFG - ULR
	Total number of channels in the stream assigned to this converter: 0000b-1111b= 1-16 channels.			

### 7.14.2. DAC0 (NID = 13h): ProcState (RA revision only)

Reg	Byte 4 (Bits 31:24)	Byte 3 (Bits 23:16)	Byte 2 (Bits 15:8)	Byte 1 (Bits 7:0)
Set				703h
Get	F0300h			

Field Name	Bits	R/W	Default	Reset
Rsvd	31:2	R	000000h	N/A (Hard-coded)
	Reserved.			
DACHPFByp	1:0	RW	1h	POR - DAFG - ULR
	Processing State: 00b= bypass the DAC HPF ("off"), 01b-11b= DAC HPF is enabled ("on" or "benign").			

#### 7.14.3. DAC0 (NID = 13h): OutAmpLeft

Reg	Byte 4 (Bits 31:24)	Byte 3 (Bits 23:16)	Byte 2 (Bits 15:8)	Byte 1 (Bits 7:0)
Set				3A0h
Get	BA000h			

Field Name	Bits	R/W	Default	Reset
Rsvd	31:8	R	000000h	N/A (Hard-coded)
	Reserved.			
Mute	7	RW	1h	POR - DAFG - ULR
	Amp mute: 1 = muted, 0 = not muted.			
Gain	6:0	RW	7Fh	POR - DAFG - ULR
	Amp gain step number (see OutAmpCap parameter pertaining to this widget).			

#### 7.14.4. DAC0 (NID = 13h): OutAmpRight

Reg	Byte 4 (Bits 31:24)	Byte 3 (Bits 23:16)	Byte 2 (Bits 15:8)	Byte 1 (Bits 7:0)
Set				390h
Get	B8000h			

Field Name	Bits	R/W	Default	Reset
Rsvd	31:8	R	000000h	N/A (Hard-coded)
	Reserved.			



Field Name	Bits	R/W	Default	Reset
Mute	7	RW	1h	POR - DAFG - ULR
Amp mute: 1 = muted, 0 = not muted.				
Gain	6:0	RW	7Fh	POR - DAFG - ULR
Amp gain step number (see OutAmpCap parameter pertaining to this widget).				

#### 7.14.5. DAC0 (NID = 13h): PwrState

Reg	Byte 4 (Bits 31:24)	Byte 3 (Bits 23:16)	Byte 2 (Bits 15:8)	Byte 1 (Bits 7:0)
Set				705h
Get	F0500h			

Field Name	Bits	R/W	Default	Reset
Rsvd4	31:11	R	000000h	N/A (Hard-coded)
Reserved.				
SettingsReset	10	R	1h	POR - DAFG - ULR
Indicates if any persistent settings in this Widget have been reset. Cleared by PwrState 'Get', or a 'Set' to any Verb in this Widget.				
Rsvd3	9	R	0h	N/A (Hard-coded)
Reserved.				
Error	8	R	0h	POR - DAFG - ULR
Error indicator: 1 = cannot enter requested power state, 0 = no problem with requested power state.				
Rsvd2	7:6	R	0h	N/A (Hard-coded)
Reserved.				
Act	5:4	R	3h	POR - DAFG - LR
Actual power state of this widget.				
Rsvd1	3:2	R	0h	N/A (Hard-coded)
Reserved.				
Set	1:0	RW	3h	POR - DAFG - LR
Current power state setting for this widget.				

**7.14.6. DAC0 (NID = 13h): CnvtrID**

Reg	Byte 4 (Bits 31:24)	Byte 3 (Bits 23:16)	Byte 2 (Bits 15:8)	Byte 1 (Bits 7:0)
Set				706h
Get	F0600h			

Field Name	Bits	R/W	Default	Reset
Rsvd	31:8	R	000000h	N/A (Hard-coded)
	Reserved.			
Strm	7:4	RW	0h	POR - S&DAFG - LR - PS
	Stream ID: 0h = Converter "off", 1h-Fh = valid ID's.			
Ch	3:0	RW	0h	POR - S&DAFG - LR - PS
	Channel assignment ("Ch" and "Ch+1" assigned as a pair, for a stereo converter).			

**7.14.7. DAC0 (NID = 13h): EAPDBTLLR**

Reg	Byte 4 (Bits 31:24)	Byte 3 (Bits 23:16)	Byte 2 (Bits 15:8)	Byte 1 (Bits 7:0)
Set				70Ch
Get	F0C00h			

Field Name	Bits	R/W	Default	Reset
Rsvd2	31:3	R	00000000h	N/A (Hard-coded)
	Reserved.			
SwapEn	2	RW	0h	POR - DAFG - ULR
	Swap enable: 1 = L/R swap enabled, 0 = L/R swap disabled.			
Rsvd1	1:0	R	0h	N/A (Hard-coded)
	Reserved.			

**7.14.8. DAC0 (NID = 13h): ProclIndex (RA revision only)**

Reg	Byte 4 (Bits 31:24)	Byte 3 (Bits 23:16)	Byte 2 (Bits 15:8)	Byte 1 (Bits 7:0)
Set				782h

**7.14.8. DAC0 (NID = 13h): ProclIndex (RA revision only)**

Reg	Byte 4 (Bits 31:24)	Byte 3 (Bits 23:16)	Byte 2 (Bits 15:8)	Byte 1 (Bits 7:0)
Get	F8200h			

Field Name	Bits	R/W	Default	Reset
Rsvd	31:3	R	000000h	N/A (Hard-coded)
	Reserved.			
CoeffIndex	2:0	RW	2h	POR - DAFG - ULR
	Processing Coeff selection. 0 = -3db response at 100Hz 1 = -3db response at 200Hz 2 = -3db response at 300Hz 3 = -3db response at 400Hz 4 = -3db response at 500Hz 5 = -3db response at 750Hz 6 = -3db response at 1000Hz 7 = -3db response at 2000Hz			

**7.15. DAC1 (NID = 14h): WCap**

Reg	Byte 4 (Bits 31:24)	Byte 3 (Bits 23:16)	Byte 2 (Bits 15:8)	Byte 1 (Bits 7:0)
Set				
Get	F0009h			

Field Name	Bits	R/W	Default	Reset
Rsvd2	31:24	R	00h	N/A (Hard-coded)
	Reserved.			
Type	23:20	R	0h	N/A (Hard-coded)
	Widget type: 0h = Out Converter 1h = In Converter 2h = Summing (Mixer) 3h = Selector (Mux) 4h = Pin Complex 5h = Power 6h = Volume Knob 7h = Beep Generator 8h-Eh = Reserved Fh = Vendor Defined			

**92HD81****SINGLE CHIP PC AUDIO SYSTEM, CODEC+SPEAKER AMPLIFIER+CAPLESS HP+LDO**

Field Name	Bits	R/W	Default	Reset
Delay	19:16	R	Dh	N/A (Hard-coded)
	Number of sample delays through widget.			
Rsvd1	15:12	R	0h	N/A (Hard-coded)
	Reserved.			
SwapCap	11	R	1h	N/A (Hard-coded)
	Left/right swap support: 1 = yes, 0 = no.			
PwrCntrl	10	R	1h	N/A (Hard-coded)
	Power state support: 1 = yes, 0 = no.			
Dig	9	R	0h	N/A (Hard-coded)
	Digital stream support: 1 = yes (digital), 0 = no (analog).			
ConnList	8	R	0h	N/A (Hard-coded)
	Connection list present: 1 = yes, 0 = no.			
UnSolCap	7	R	0h	N/A (Hard-coded)
	Unsolicited response support: 1 = yes, 0 = no.			
ProcWidget	6	R	0h	N/A (Hard-coded)
	Processing state support: 1 = yes, 0 = no.			
Stripe	5	R	0h	N/A (Hard-coded)
	Striping support: 1 = yes, 0 = no.			
FormatOvrd	4	R	0h	N/A (Hard-coded)
	Stream format override: 1 = yes, 0 = no.			
AmpParOvrd	3	R	0h	N/A (Hard-coded)
	Amplifier capabilities override: 1 = yes, no.			
OutAmpPrsnt	2	R	1h	N/A (Hard-coded)
	Output amp present: 1 = yes, 0 = no.			
InAmpPrsnt	1	R	0h	N/A (Hard-coded)
	Input amp present: 1 = yes, 0 = no.			
Stereo	0	R	1h	N/A (Hard-coded)
	Stereo stream support: 1 = yes (stereo), 0 = no (mono).			

**7.15.1. DAC1 (NID = 14h): Cnvtr**

Reg	Byte 4 (Bits 31:24)	Byte 3 (Bits 23:16)	Byte 2 (Bits 15:8)	Byte 1 (Bits 7:0)
Set				2h
Get	A0000h			

Field Name	Bits	R/W	Default	Reset
Rsvd2	31:16	R	0000h	N/A (Hard-coded)
	Reserved.			
StrmType	15	R	0h	N/A (Hard-coded)
	Stream type: 1 = Non-PCM, 0 = PCM.			
FrmtSmplRate	14	RW	0h	POR - DAFG - ULR
	Sample base rate: 1 = 44.1kHz, 0 = 48kHz.			
SmplRateMltp	13:11	RW	0h	POR - DAFG - ULR
	Sample base rate multiple: 000b= x1 (48kHz/44.1kHz or less) 001b= x2 (96kHz/88.2kHz/32kHz) 010b= x3 (144kHz) 011b= x4 (192kHz/176.4kHz) 100b-111b Reserved			
SmplRateDiv	10:8	RW	0h	POR - DAFG - ULR
	Sample base rate divider: 000b= Divide by 1 (48kHz/44.1kHz) 001b= Divide by 2 (24kHz/20.05kHz) 010b= Divide by 3 (16kHz/32kHz) 011b= Divide by 4 (11.025kHz) 100b= Divide by 5 (9.6kHz) 101b= Divide by 6 (8kHz) 110b= Divide by 7 111b= Divide by 8 (6kHz)			
Rsvd1	7	R	0h	N/A (Hard-coded)
	Reserved.			

Field Name	Bits	R/W	Default	Reset
BitsPerSmpl	6:4	RW	3h	POR - DAFG - ULR
	Bits per sample: 000b= 8 bits 001b= 16 bits 010b= 20 bits 011b= 24 bits 100b= 32 bits 101b-111b= Reserved			
NmbrChan	3:0	RW	1h	POR - DAFG - ULR
	Total number of channels in the stream assigned to this converter: 0000b-1111b= 1-16 channels.			

**7.15.2. DAC1 (NID = 14h): ProcState (RA revision only)**

Reg	Byte 4 (Bits 31:24)	Byte 3 (Bits 23:16)	Byte 2 (Bits 15:8)	Byte 1 (Bits 7:0)
Set				703h
Get	F0300h			

Field Name	Bits	R/W	Default	Reset
Rsvd	31:2	R	000000h	N/A (Hard-coded)
	Reserved.			
DACHPFByp	1:0	RW	1h	POR - DAFG - ULR
	Processing State: 00b= bypass the DAC HPF ("off"), 01b-11b= DAC HPF is enabled ("on" or "benign").			

**7.15.3. DAC1 (NID = 14h): OutAmpLeft**

Reg	Byte 4 (Bits 31:24)	Byte 3 (Bits 23:16)	Byte 2 (Bits 15:8)	Byte 1 (Bits 7:0)
Set				3A0h
Get	BA000h			

Field Name	Bits	R/W	Default	Reset
Rsvd	31:8	R	000000h	N/A (Hard-coded)
	Reserved.			
Mute	7	RW	1h	POR - DAFG - ULR
	Amp mute: 1 = muted, 0 = not muted.			
Gain	6:0	RW	7Fh	POR - DAFG - ULR
	Amp gain step number (see OutAmpCap parameter pertaining to this widget).			

#### 7.15.4. DAC1 (NID = 14h): OutAmpRight

Reg	Byte 4 (Bits 31:24)	Byte 3 (Bits 23:16)	Byte 2 (Bits 15:8)	Byte 1 (Bits 7:0)
Set				390h
Get	B8000h			

Field Name	Bits	R/W	Default	Reset
Rsvd	31:8	R	000000h	N/A (Hard-coded)
	Reserved.			
Mute	7	RW	1h	POR - DAFG - ULR
	Amp mute: 1 = muted, 0 = not muted.			
Gain	6:0	RW	7Fh	POR - DAFG - ULR
	Amp gain step number (see OutAmpCap parameter pertaining to this widget).			

#### 7.15.5. DAC1 (NID = 14h): PwrState

Reg	Byte 4 (Bits 31:24)	Byte 3 (Bits 23:16)	Byte 2 (Bits 15:8)	Byte 1 (Bits 7:0)
Set				705h
Get	F0500h			

Field Name	Bits	R/W	Default	Reset
Rsvd4	31:11	R	000000h	N/A (Hard-coded)
	Reserved.			

# 92HD81

## SINGLE CHIP PC AUDIO SYSTEM, CODEC+SPEAKER AMPLIFIER+CAPLESS HP+LDO

Field Name	Bits	R/W	Default	Reset
SettingsReset	10	R	1h	POR - DAFG - ULR
	Indicates if any persistent settings in this Widget have been reset. Cleared by PwrState 'Get', or a 'Set' to any Verb in this Widget.			
Rsvd3	9	R	0h	N/A (Hard-coded)
	Reserved.			
Error	8	R	0h	POR - DAFG - ULR
	Error indicator: 1 = cannot enter requested power state, 0 = no problem with requested power state.			
Rsvd2	7:6	R	0h	N/A (Hard-coded)
	Reserved.			
Act	5:4	R	3h	POR - DAFG - LR
	Actual power state of this widget.			
Rsvd1	3:2	R	0h	N/A (Hard-coded)
	Reserved.			
Set	1:0	RW	3h	POR - DAFG - LR
	Current power state setting for this widget.			

### 7.15.6. DAC1 (NID = 14h): CnvtrID

Reg	Byte 4 (Bits 31:24)	Byte 3 (Bits 23:16)	Byte 2 (Bits 15:8)	Byte 1 (Bits 7:0)
Set				706h
Get	F0600h			

Field Name	Bits	R/W	Default	Reset
Rsvd	31:8	R	000000h	N/A (Hard-coded)
	Reserved.			
Strm	7:4	RW	0h	POR - S&DAFG - LR - PS
	Stream ID: 0h = Converter "off", 1h-Fh = valid ID's.			
Ch	3:0	RW	0h	POR - S&DAFG - LR - PS
	Channel assignment ("Ch" and "Ch+1" assigned as a pair, for a stereo converter).			



**7.15.7. DAC1 (NID = 14h): EAPDBTLLR**

Reg	Byte 4 (Bits 31:24)	Byte 3 (Bits 23:16)	Byte 2 (Bits 15:8)	Byte 1 (Bits 7:0)
Set				70Ch
Get	F0C00h			

Field Name	Bits	R/W	Default	Reset
Rsvd2	31:3	R	00000000h	N/A (Hard-coded)
	Reserved.			
SwapEn	2	RW	0h	POR - DAFG - ULR
	Swap enable: 1 = L/R swap enabled, 0 = L/R swap disabled.			
Rsvd1	1:0	R	0h	N/A (Hard-coded)
	Reserved.			

**7.15.8. DAC1 (NID = 14h): ProclIndex (RA revision only)**

Reg	Byte 4 (Bits 31:24)	Byte 3 (Bits 23:16)	Byte 2 (Bits 15:8)	Byte 1 (Bits 7:0)
Set				782h
Get	F8200h			

Field Name	Bits	R/W	Default	Reset
Rsvd	31:3	R	000000h	N/A (Hard-coded)
	Reserved.			
CoeffIndex	2:0	RW	2h	POR - DAFG - ULR
	Processing Coeff selection. 0 = -3db response at 100Hz 1 = -3db response at 200Hz 2 = -3db response at 300Hz 3 = -3db response at 400Hz 4 = -3db response at 500Hz 5 = -3db response at 750Hz 6 = -3db response at 1000Hz 7 = -3db response at 2000Hz			

## 7.16. DAC2 (NID = 22h): WCap

Reg	Byte 4 (Bits 31:24)	Byte 3 (Bits 23:16)	Byte 2 (Bits 15:8)	Byte 1 (Bits 7:0)
Set				
Get	F0009h			

Field Name	Bits	R/W	Default	Reset
Rsvd2	31:24	R	00h	N/A (Hard-coded)
	Reserved.			
Type	23:20	R	Fh	N/A (Hard-coded)
	Widget type: 0h = Out Converter 1h = In Converter 2h = Summing (Mixer) 3h = Selector (Mux) 4h = Pin Complex 5h = Power 6h = Volume Knob 7h = Beep Generator 8h-Eh = Reserved Fh = Vendor Defined			
Delay	19:16	R	0h	N/A (Hard-coded)
	Number of sample delays through widget.			
Rsvd1	15:12	R	0h	N/A (Hard-coded)
	Reserved.			
SwapCap	11	R	0h	N/A (Hard-coded)
	Left/right swap support: 1 = yes, 0 = no.			
PwrCntrl	10	R	0h	N/A (Hard-coded)
	Power state support: 1 = yes, 0 = no.			
Dig	9	R	0h	N/A (Hard-coded)
	Digital stream support: 1 = yes (digital), 0 = no (analog).			
ConnList	8	R	0h	N/A (Hard-coded)
	Connection list present: 1 = yes, 0 = no.			
UnSolCap	7	R	0h	N/A (Hard-coded)
	Unsolicited response support: 1 = yes, 0 = no.			

Field Name	Bits	R/W	Default	Reset
ProcWidget	6	R	0h	N/A (Hard-coded)
	Processing state support: 1 = yes, 0 = no.			
Stripe	5	R	0h	N/A (Hard-coded)
	Striping support: 1 = yes, 0 = no.			
FormatOvr	4	R	0h	N/A (Hard-coded)
	Stream format override: 1 = yes, 0 = no.			
AmpParOvr	3	R	0h	N/A (Hard-coded)
	Amplifier capabilities override: 1 = yes, no.			
OutAmpPrsnt	2	R	0h	N/A (Hard-coded)
	Output amp present: 1 = yes, 0 = no.			
InAmpPrsnt	1	R	0h	N/A (Hard-coded)
	Input amp present: 1 = yes, 0 = no.			
Stereo	0	R	0h	N/A (Hard-coded)
	Stereo stream support: 1 = yes (stereo), 0 = no (mono).			

### 7.16.1. DAC2 (NID = 22h): Cnvtr

Reg	Byte 4 (Bits 31:24)	Byte 3 (Bits 23:16)	Byte 2 (Bits 15:8)	Byte 1 (Bits 7:0)
Set				2h
Get	A0000h			

Field Name	Bits	R/W	Default	Reset
Rsvd2	31:16	R	0000h	N/A (Hard-coded)
	Reserved.			
StrmType	15	R	0h	N/A (Hard-coded)
	Stream type: 1 = Non-PCM, 0 = PCM.			
FrmtSmpIRate	14	R	0h	N/A (Hard-coded)
	Sample base rate: 1 = 44.1kHz, 0 = 48kHz.			

Field Name	Bits	R/W	Default	Reset
SmplRateMultp	13:11	R	0h	N/A (Hard-coded)
	Sample base rate multiple: 000b= x1 (48kHz/44.1kHz or less) 001b= x2 (96kHz/88.2kHz/32kHz) 010b= x3 (144kHz) 011b= x4 (192kHz/176.4kHz) 100b-111b Reserved			
SmplRateDiv	10:8	R	0h	N/A (Hard-coded)
	Sample base rate divider: 000b= Divide by 1 (48kHz/44.1kHz) 001b= Divide by 2 (24kHz/20.05kHz) 010b= Divide by 3 (16kHz/32kHz) 011b= Divide by 4 (11.025kHz) 100b= Divide by 5 (9.6kHz) 101b= Divide by 6 (8kHz) 110b= Divide by 7 111b= Divide by 8 (6kHz)			
Rsvd1	7	R	0h	N/A (Hard-coded)
	Reserved.			
BitsPerSmpl	6:4	R	0h	N/A (Hard-coded)
	Bits per sample: 000b= 8 bits 001b= 16 bits 010b= 20 bits 011b= 24 bits 100b= 32 bits 101b-111b= Reserved			
NmbrChan	3:0	R	0h	N/A (Hard-coded)
	Total number of channels in the stream assigned to this converter: 0000b-1111b= 1-16 channels.			

### 7.16.2. DAC2 (NID = 22h): OutAmpLeft

Reg	Byte 4 (Bits 31:24)	Byte 3 (Bits 23:16)	Byte 2 (Bits 15:8)	Byte 1 (Bits 7:0)
Set				3A0h
Get	BA00h			

Field Name	Bits	R/W	Default	Reset
Rsvd	31:8	R	000000h	N/A (Hard-coded)
	Reserved.			
Mute	7	R	0h	N/A (Hard-coded)
	Amp mute: 1 = muted, 0 = not muted.			
Gain	6:0	R	00h	N/A (Hard-coded)
	Amp gain step number (see OutAmpCap parameter pertaining to this widget).			

### 7.16.3. DAC2 (NID = 22h): OutAmpRight

Reg	Byte 4 (Bits 31:24)	Byte 3 (Bits 23:16)	Byte 2 (Bits 15:8)	Byte 1 (Bits 7:0)
Set				390h
Get	B8000h			

Field Name	Bits	R/W	Default	Reset
Rsvd	31:8	R	000000h	N/A (Hard-coded)
	Reserved.			
Mute	7	R	0h	N/A (Hard-coded)
	Amp mute: 1 = muted, 0 = not muted.			
Gain	6:0	R	00h	N/A (Hard-coded)
	Amp gain step number (see OutAmpCap parameter pertaining to this widget).			

### 7.16.4. DAC2 (NID = 22h): PwrState

Reg	Byte 4 (Bits 31:24)	Byte 3 (Bits 23:16)	Byte 2 (Bits 15:8)	Byte 1 (Bits 7:0)
Set				705h
Get	F0500h			

Field Name	Bits	R/W	Default	Reset
Rsvd4	31:11	R	000000h	N/A (Hard-coded)
	Reserved.			

# 92HD81

## SINGLE CHIP PC AUDIO SYSTEM, CODEC+SPEAKER AMPLIFIER+CAPLESS HP+LDO

Field Name	Bits	R/W	Default	Reset
SettingsReset	10	R	0h	N/A (Hard-coded)
	Indicates if any persistent settings in this Widget have been reset. Cleared by PwrState 'Get', or a 'Set' to any Verb in this Widget.			
Rsvd3	9	R	0h	N/A (Hard-coded)
	Reserved.			
Error	8	R	0h	N/A (Hard-coded)
	Error indicator: 1 = cannot enter requested power state, 0 = no problem with requested power state.			
Rsvd2	7:6	R	0h	N/A (Hard-coded)
	Reserved.			
Act	5:4	R	0h	N/A (Hard-coded)
	Actual power state of this widget.			
Rsvd1	3:2	R	0h	N/A (Hard-coded)
	Reserved.			
Set	1:0	R	0h	N/A (Hard-coded)
	Current power state setting for this widget.			

### 7.16.5. DAC2 (NID = 22h): CnvtrID

Reg	Byte 4 (Bits 31:24)	Byte 3 (Bits 23:16)	Byte 2 (Bits 15:8)	Byte 1 (Bits 7:0)
Set				706h
Get	F0600h			

Field Name	Bits	R/W	Default	Reset
Rsvd	31:8	R	000000h	N/A (Hard-coded)
	Reserved.			
Strm	7:4	R	0h	N/A (Hard-coded)
	Stream ID: 0h = Converter "off", 1h-Fh = valid ID's.			
Ch	3:0	R	0h	N/A (Hard-coded)
	Channel assignment ("Ch" and "Ch+1" assigned as a pair, for a stereo converter).			

**7.16.6. DAC2 (NID = 22h): EAPDBTLLR**

Reg	Byte 4 (Bits 31:24)	Byte 3 (Bits 23:16)	Byte 2 (Bits 15:8)	Byte 1 (Bits 7:0)
Set				70Ch
Get	F0C00h			

Field Name	Bits	R/W	Default	Reset
Rsvd2	31:3	R	00000000h	N/A (Hard-coded)
	Reserved.			
SwapEn	2	R	0h	N/A (Hard-coded)
	Swap enable: 1 = L/R swap enabled, 0 = L/R swap disabled.			
Rsvd1	1:0	R	0h	N/A (Hard-coded)
	Reserved.			

**7.17. ADC0 (NID = 15h): WCap**

Reg	Byte 4 (Bits 31:24)	Byte 3 (Bits 23:16)	Byte 2 (Bits 15:8)	Byte 1 (Bits 7:0)
Set				
Get	F0009h			

Field Name	Bits	R/W	Default	Reset
Rsvd2	31:24	R	00h	N/A (Hard-coded)
	Reserved.			
Type	23:20	R	1h	N/A (Hard-coded)
Widget type: 0h = Out Converter 1h = In Converter 2h = Summing (Mixer) 3h = Selector (Mux) 4h = Pin Complex 5h = Power 6h = Volume Knob 7h = Beep Generator 8h-Eh = Reserved Fh = Vendor Defined				

# 92HD81

## SINGLE CHIP PC AUDIO SYSTEM, CODEC+SPEAKER AMPLIFIER+CAPLESS HP+LDO

Field Name	Bits	R/W	Default	Reset
Delay	19:16	R	Dh	N/A (Hard-coded)
	Number of sample delays through widget.			
Rsvd1	15:12	R	0h	N/A (Hard-coded)
	Reserved.			
SwapCap	11	R	0h	N/A (Hard-coded)
	Left/right swap support: 1 = yes, 0 = no.			
PwrCntrl	10	R	1h	N/A (Hard-coded)
	Power state support: 1 = yes, 0 = no.			
Dig	9	R	0h	N/A (Hard-coded)
	Digital stream support: 1 = yes (digital), 0 = no (analog).			
ConnList	8	R	1h	N/A (Hard-coded)
	Connection list present: 1 = yes, 0 = no.			
UnSolCap	7	R	0h	N/A (Hard-coded)
	Unsolicited response support: 1 = yes, 0 = no.			
ProcWidget	6	R	1h	N/A (Hard-coded)
	Processing state support: 1 = yes, 0 = no.			
Stripe	5	R	0h	N/A (Hard-coded)
	Striping support: 1 = yes, 0 = no.			
FormatOvrd	4	R	0h	N/A (Hard-coded)
	Stream format override: 1 = yes, 0 = no.			
AmpParOvrd	3	R	0h	N/A (Hard-coded)
	Amplifier capabilities override: 1 = yes, no.			
OutAmpPrsnt	2	R	0h	N/A (Hard-coded)
	Output amp present: 1 = yes, 0 = no.			
InAmpPrsnt	1	R	0h	N/A (Hard-coded)
	Input amp present: 1 = yes, 0 = no.			
Stereo	0	R	1h	N/A (Hard-coded)
	Stereo stream support: 1 = yes (stereo), 0 = no (mono).			



**7.17.1. ADC0 (NID = 15h): ConLst**

Reg	Byte 4 (Bits 31:24)	Byte 3 (Bits 23:16)	Byte 2 (Bits 15:8)	Byte 1 (Bits 7:0)
Set				
Get	F000Eh			

Field Name	Bits	R/W	Default	Reset
Rsvd	31:8	R	000000h	N/A (Hard-coded)
	Reserved.			
LForm	7	R	0h	N/A (Hard-coded)
	Connection list format: 1 = long-form (15-bit) NID entries, 0 = short-form (7-bit) NID entries.			
ConL	6:0	R	01h	N/A (Hard-coded)
	Number of NID entries in connection list.			

**7.17.2. ADC0 (NID = 15h): ConLstEntry0**

Reg	Byte 4 (Bits 31:24)	Byte 3 (Bits 23:16)	Byte 2 (Bits 15:8)	Byte 1 (Bits 7:0)
Set				
Get	F0200h			

Field Name	Bits	R/W	Default	Reset
ConL3	31:24	R	00h	N/A (Hard-coded)
	Unused list entry.			
ConL2	23:16	R	00h	N/A (Hard-coded)
	Unused list entry.			
ConL1	15:8	R	00h	N/A (Hard-coded)
	Unused list entry.			
ConL0	7:0	R	17h	N/A (Hard-coded)
	ADC0Mux Selector widget (0x18)			

## 7.17.3. ADC0 (NID = 15h): Cnvtr

Reg	Byte 4 (Bits 31:24)	Byte 3 (Bits 23:16)	Byte 2 (Bits 15:8)	Byte 1 (Bits 7:0)
Set				2h
Get	A0000h			

Field Name	Bits	R/W	Default	Reset
Rsvd2	31:16	R	0000h	N/A (Hard-coded)
	Reserved.			
StrmType	15	R	0h	N/A (Hard-coded)
	Stream type: 1 = Non-PCM, 0 = PCM.			
FrmtSmplRate	14	RW	0h	POR - DAFG - ULR
	Sample base rate: 1 = 44.1kHz, 0 = 48kHz.			
SmplRateMltp	13:11	RW	0h	POR - DAFG - ULR
	Sample base rate multiple: 000b= x1 (48kHz/44.1kHz or less) 001b= x2 (96kHz/88.2kHz/32kHz) 010b= x3 (144kHz) 011b= x4 (192kHz/176.4kHz) 100b-111b Reserved			
SmplRateDiv	10:8	RW	0h	POR - DAFG - ULR
	Sample base rate divider: 000b= Divide by 1 (48kHz/44.1kHz) 001b= Divide by 2 (24kHz/20.05kHz) 010b= Divide by 3 (16kHz/32kHz) 011b= Divide by 4 (11.025kHz) 100b= Divide by 5 (9.6kHz) 101b= Divide by 6 (8kHz) 110b= Divide by 7 111b= Divide by 8 (6kHz)			
Rsvd1	7	R	0h	N/A (Hard-coded)
	Reserved.			

Field Name	Bits	R/W	Default	Reset
BitsPerSmpl	6:4	RW	3h	POR - DAFG - ULR
	Bits per sample: 000b= 8 bits 001b= 16 bits 010b= 20 bits 011b= 24 bits 100b= 32 bits 101b-111b= Reserved			
NmbrChan	3:0	RW	1h	POR - DAFG - ULR
	Total number of channels in the stream assigned to this converter: 0000b-1111b= 1-16 channels.			

#### 7.17.4. ADC0 (NID = 15h): ProcState

Reg	Byte 4 (Bits 31:24)	Byte 3 (Bits 23:16)	Byte 2 (Bits 15:8)	Byte 1 (Bits 7:0)
Set				703h
Get	F0300h			

Field Name	Bits	R/W	Default	Reset
Rsvd2	31:8	R	000000h	N/A (Hard-coded)
	Reserved.			
HPFOCDIS	7	RW	0h	POR - DAFG - ULR
	HPF offset calculation disable. 1 = calculation disabled; 0 = calculation enabled.			
Rsvd1	6:2	R	00h	N/A (Hard-coded)
	Reserved.			
ADCHPFByp	1:0	RW	1h	POR - DAFG - ULR
	Processing State: 00b= bypass the ADC HPF ("off"), 01b-11b= ADC HPF is enabled ("on" or "benign").			

#### 7.17.5. ADC0 (NID = 15h): PwrState

Reg	Byte 4 (Bits 31:24)	Byte 3 (Bits 23:16)	Byte 2 (Bits 15:8)	Byte 1 (Bits 7:0)
Set				705h
Get	F0500h			

Field Name	Bits	R/W	Default	Reset
Rsvd4	31:11	R	000000h	N/A (Hard-coded)
	Reserved.			
SettingsReset	10	R	1h	POR - DAFG - ULR
	Indicates if any persistent settings in this Widget have been reset. Cleared by PwrState 'Get', or a 'Set' to any Verb in this Widget.			
Rsvd3	9	R	0h	N/A (Hard-coded)
	Reserved.			
Error	8	R	0h	POR - DAFG - ULR
	Error indicator: 1 = cannot enter requested power state, 0 = no problem with requested power state.			
Rsvd2	7:6	R	0h	N/A (Hard-coded)
	Reserved.			
Act	5:4	R	3h	POR - DAFG - LR
	Actual power state of this widget.			
Rsvd1	3:2	R	0h	N/A (Hard-coded)
	Reserved.			
Set	1:0	RW	3h	POR - DAFG - LR
	Current power state setting for this widget.			

#### 7.17.6. ADC0 (NID = 15h): CnvtrID

Reg	Byte 4 (Bits 31:24)	Byte 3 (Bits 23:16)	Byte 2 (Bits 15:8)	Byte 1 (Bits 7:0)
Set				706h
Get	F0600h			

Field Name	Bits	R/W	Default	Reset
Rsvd	31:8	R	000000h	N/A (Hard-coded)
	Reserved.			
Strm	7:4	RW	0h	POR - S&DAFG - LR - PS
	Stream ID: 0h = Converter "off", 1h-Fh = valid ID's.			

Field Name	Bits	R/W	Default	Reset
Ch	3:0	RW	0h	POR - S&DAFG - LR - PS
Channel assignment ("Ch" and "Ch+1" assigned as a pair, for a stereo converter).				

### 7.18. ADC1 (NID = 16h): WCap

Reg	Byte 4 (Bits 31:24)	Byte 3 (Bits 23:16)	Byte 2 (Bits 15:8)	Byte 1 (Bits 7:0)
Set				
Get	F0009h			

Field Name	Bits	R/W	Default	Reset
Rsvd2	31:24	R	00h	N/A (Hard-coded)
Reserved.				
Type	23:20	R	1h	N/A (Hard-coded)
Widget type: 0h = Out Converter 1h = In Converter 2h = Summing (Mixer) 3h = Selector (Mux) 4h = Pin Complex 5h = Power 6h = Volume Knob 7h = Beep Generator 8h-Eh = Reserved Fh = Vendor Defined				
Delay	19:16	R	Dh	N/A (Hard-coded)
Number of sample delays through widget.				
Rsvd1	15:12	R	0h	N/A (Hard-coded)
Reserved.				
SwapCap	11	R	0h	N/A (Hard-coded)
Left/right swap support: 1 = yes, 0 = no.				
PwrCntrl	10	R	1h	N/A (Hard-coded)
Power state support: 1 = yes, 0 = no.				

Field Name	Bits	R/W	Default	Reset
Dig	9	R	0h	N/A (Hard-coded)
	Digital stream support: 1 = yes (digital), 0 = no (analog).			
ConnList	8	R	1h	N/A (Hard-coded)
	Connection list present: 1 = yes, 0 = no.			
UnSolCap	7	R	0h	N/A (Hard-coded)
	Unsolicited response support: 1 = yes, 0 = no.			
ProcWidget	6	R	1h	N/A (Hard-coded)
	Processing state support: 1 = yes, 0 = no.			
Stripe	5	R	0h	N/A (Hard-coded)
	Striping support: 1 = yes, 0 = no.			
FormatOvrd	4	R	0h	N/A (Hard-coded)
	Stream format override: 1 = yes, 0 = no.			
AmpParOvrd	3	R	0h	N/A (Hard-coded)
	Amplifier capabilities override: 1 = yes, no.			
OutAmpPrsnt	2	R	0h	N/A (Hard-coded)
	Output amp present: 1 = yes, 0 = no.			
InAmpPrsnt	1	R	0h	N/A (Hard-coded)
	Input amp present: 1 = yes, 0 = no.			
Stereo	0	R	1h	N/A (Hard-coded)
	Stereo stream support: 1 = yes (stereo), 0 = no (mono).			

### 7.18.1. ADC1 (NID = 16h): ConLst

Reg	Byte 4 (Bits 31:24)	Byte 3 (Bits 23:16)	Byte 2 (Bits 15:8)	Byte 1 (Bits 7:0)
Set				
Get	F000Eh			

Field Name	Bits	R/W	Default	Reset
Rsvd	31:8	R	000000h	N/A (Hard-coded)
	Reserved.			
LForm	7	R	0h	N/A (Hard-coded)
	Connection list format: 1 = long-form (15-bit) NID entries, 0 = short-form (7-bit) NID entries.			
ConL	6:0	R	01h	N/A (Hard-coded)
	Number of NID entries in connection list.			

**7.18.2. ADC1 (NID = 16h): ConLstEntry0**

Reg	Byte 4 (Bits 31:24)	Byte 3 (Bits 23:16)	Byte 2 (Bits 15:8)	Byte 1 (Bits 7:0)
Set				
Get	F0200h			

Field Name	Bits	R/W	Default	Reset
ConL3	31:24	R	00h	N/A (Hard-coded)
	Unused list entry.			
ConL2	23:16	R	00h	N/A (Hard-coded)
	Unused list entry.			
ConL1	15:8	R	00h	N/A (Hard-coded)
	Unused list entry.			
ConL0	7:0	R	18h	N/A (Hard-coded)
	ADC1Mux widget (0x18)			

**7.18.3. ADC1 (NID = 16h): Cnvtr**

Reg	Byte 4 (Bits 31:24)	Byte 3 (Bits 23:16)	Byte 2 (Bits 15:8)	Byte 1 (Bits 7:0)
Set				2h
Get	A0000h			

# 92HD81

## SINGLE CHIP PC AUDIO SYSTEM, CODEC+SPEAKER AMPLIFIER+CAPLESS HP+LDO

Field Name	Bits	R/W	Default	Reset
Rsvd2	31:16	R	0000h	N/A (Hard-coded)
	Reserved.			
StrmType	15	R	0h	N/A (Hard-coded)
	Stream type: 1 = Non-PCM, 0 = PCM.			
FrmtSmplRate	14	RW	0h	POR - DAFG - ULR
	Sample base rate: 1 = 44.1kHz, 0 = 48kHz.			
SmplRateMultp	13:11	RW	0h	POR - DAFG - ULR
	Sample base rate multiple: 000b= x1 (48kHz/44.1kHz or less) 001b= x2 (96kHz/88.2kHz/32kHz) 010b= x3 (144kHz) 011b= x4 (192kHz/176.4kHz) 100b-111b Reserved			
SmplRateDiv	10:8	RW	0h	POR - DAFG - ULR
	Sample base rate divider: 000b= Divide by 1 (48kHz/44.1kHz) 001b= Divide by 2 (24kHz/20.05kHz) 010b= Divide by 3 (16kHz/32kHz) 011b= Divide by 4 (11.025kHz) 100b= Divide by 5 (9.6kHz) 101b= Divide by 6 (8kHz) 110b= Divide by 7 111b= Divide by 8 (6kHz)			
Rsvd1	7	R	0h	N/A (Hard-coded)
	Reserved.			
BitsPerSmpl	6:4	RW	3h	POR - DAFG - ULR
	Bits per sample: 000b= 8 bits 001b= 16 bits 010b= 20 bits 011b= 24 bits 100b= 32 bits 101b-111b= Reserved			
NmbrChan	3:0	RW	1h	POR - DAFG - ULR
	Total number of channels in the stream assigned to this converter: 0000b-1111b= 1-16 channels.			



**7.18.4. ADC1 (NID = 16h): ProcState**

Reg	Byte 4 (Bits 31:24)	Byte 3 (Bits 23:16)	Byte 2 (Bits 15:8)	Byte 1 (Bits 7:0)
Set				703h
Get	F0300h			

Field Name	Bits	R/W	Default	Reset
Rsvd2	31:8	R	000000h	N/A (Hard-coded)
	Reserved.			
HPFOCDIS	7	RW	0h	POR - DAFG - ULR
	HPF offset calculation disable. 1 = calculation disabled; 0 = calculation enabled.			
Rsvd1	6:2	R	00h	N/A (Hard-coded)
	Reserved.			
ADCHPFByp	1:0	RW	1h	POR - DAFG - ULR
	Processing State: 00b= bypass the ADC HPF ("off"), 01b-11b= ADC HPF is enabled ("on" or "benign").			

**7.18.5. ADC1 (NID = 16h): PwrState**

Reg	Byte 4 (Bits 31:24)	Byte 3 (Bits 23:16)	Byte 2 (Bits 15:8)	Byte 1 (Bits 7:0)
Set				705h
Get	F0500h			

Field Name	Bits	R/W	Default	Reset
Rsvd4	31:11	R	000000h	N/A (Hard-coded)
	Reserved.			
SettingsReset	10	R	1h	POR - DAFG - ULR
	Indicates if any persistent settings in this Widget have been reset. Cleared by PwrState 'Get', or a 'Set' to any Verb in this Widget.			
Rsvd3	9	R	0h	N/A (Hard-coded)
	Reserved.			

Field Name	Bits	R/W	Default	Reset
Error	8	R	0h	POR - DAFG - ULR
	Error indicator: 1 = cannot enter requested power state, 0 = no problem with requested power state.			
Rsvd2	7:6	R	0h	N/A (Hard-coded)
	Reserved.			
Act	5:4	R	3h	POR - DAFG - LR
	Actual power state of this widget.			
Rsvd1	3:2	R	0h	N/A (Hard-coded)
	Reserved.			
Set	1:0	RW	3h	POR - DAFG - LR
	Current power state setting for this widget.			

#### 7.18.6. ADC1 (NID = 16h): CnvtrID

Reg	Byte 4 (Bits 31:24)	Byte 3 (Bits 23:16)	Byte 2 (Bits 15:8)	Byte 1 (Bits 7:0)
Set				706h
Get	F0600h			

Field Name	Bits	R/W	Default	Reset
Rsvd	31:8	R	000000h	N/A (Hard-coded)
	Reserved.			
Strm	7:4	RW	0h	POR - S&DAFG - LR - PS
	Stream ID: 0h = Converter "off", 1h-Fh = valid ID's.			
Ch	3:0	RW	0h	POR - S&DAFG - LR - PS
	Channel assignment ("Ch" and "Ch+1" assigned as a pair, for a stereo converter).			

#### 7.19. ADC0Mux (NID = 17h): WCap

Reg	Byte 4 (Bits 31:24)	Byte 3 (Bits 23:16)	Byte 2 (Bits 15:8)	Byte 1 (Bits 7:0)
Set				
Get	F0009h			

# 92HD81

## SINGLE CHIP PC AUDIO SYSTEM, CODEC+SPEAKER AMPLIFIER+CAPLESS HP+LDO

Field Name	Bits	R/W	Default	Reset
Rsvd2	31:24	R	00h	N/A (Hard-coded)
	Reserved.			
Type	23:20	R	3h	N/A (Hard-coded)
	Widget type: 0h = Out Converter 1h = In Converter 2h = Summing (Mixer) 3h = Selector (Mux) 4h = Pin Complex 5h = Power 6h = Volume Knob 7h = Beep Generator 8h-Eh = Reserved Fh = Vendor Defined			
Delay	19:16	R	0h	N/A (Hard-coded)
	Number of sample delays through widget.			
Rsvd1	15:12	R	0h	N/A (Hard-coded)
	Reserved.			
SwapCap	11	R	1h	N/A (Hard-coded)
	Left/right swap support: 1 = yes, 0 = no.			
PwrCntrl	10	R	1h	N/A (Hard-coded)
	Power state support: 1 = yes, 0 = no.			
DigitalStrm	9	R	0h	N/A (Hard-coded)
	Digital stream support: 1 = yes (digital), 0 = no (analog).			
ConnList	8	R	1h	N/A (Hard-coded)
	Connection list present: 1 = yes, 0 = no.			
UnsolCap	7	R	0h	N/A (Hard-coded)
	Unsolicited response support: 1 = yes, 0 = no.			
ProcWidget	6	R	0h	N/A (Hard-coded)
	Processing state support: 1 = yes, 0 = no.			
Stripe	5	R	0h	N/A (Hard-coded)
	Striping support: 1 = yes, 0 = no.			

Field Name	Bits	R/W	Default	Reset
FormatOvrD	4	R	0h	N/A (Hard-coded)
	Stream format override: 1 = yes, 0 = no.			
AmpParamOvrD	3	R	1h	N/A (Hard-coded)
	Amplifier capabilities override: 1 = yes, no.			
OutAmpPrsnt	2	R	1h	N/A (Hard-coded)
	Output amp present: 1 = yes, 0 = no.			
InAmpPrsnt	1	R	0h	N/A (Hard-coded)
	Input amp present: 1 = yes, 0 = no.			
Stereo	0	R	1h	N/A (Hard-coded)
	Stereo stream support: 1 = yes (stereo), 0 = no (mono).			

#### 7.19.1. ADC0Mux (NID = 17h): ConLst

Reg	Byte 4 (Bits 31:24)	Byte 3 (Bits 23:16)	Byte 2 (Bits 15:8)	Byte 1 (Bits 7:0)
Set				
Get	F000Eh			

Field Name	Bits	R/W	Default	Reset
Rsvd	31:8	R	000000h	N/A (Hard-coded)
	Reserved.			
LForm	7	R	0h	N/A (Hard-coded)
	Connection list format: 1 = long-form (15-bit) NID entries, 0 = short-form (7-bit) NID entries.			
ConL	6:0	R	07h	N/A (Hard-coded)
	Number of NID entries in connection list.			

#### 7.19.2. ADC0Mux (NID = 17h): ConLstEntry4

Reg	Byte 4 (Bits 31:24)	Byte 3 (Bits 23:16)	Byte 2 (Bits 15:8)	Byte 1 (Bits 7:0)
Set				
Get	F0204h			

Field Name	Bits	R/W	Default	Reset
ConL7	31:24	R	00h	N/A (Hard-coded)
	Unused list entry.			
ConL6	23:16	R	0Ah	N/A (Hard-coded)
	Port A Pin widget (0x0A)			
ConL5	15:8	R	12h	N/A (Hard-coded)
	DMic1Vol Selector widget (0x12)			
ConL4	7:0	R	11h	N/A (Hard-coded)
	DMic0 Pin widget (0x11)			

### 7.19.3. ADC0Mux (NID = 17h): ConLstEntry0

Reg	Byte 4 (Bits 31:24)	Byte 3 (Bits 23:16)	Byte 2 (Bits 15:8)	Byte 1 (Bits 7:0)
Set				
Get	F0200h			

Field Name	Bits	R/W	Default	Reset
ConL3	31:24	R	1Bh	N/A (Hard-coded)
	Mixer Summing widget (0x1B)			
ConL2	23:16	R	0Fh	N/A (Hard-coded)
	Port F Pin widget (0x0F)			
ConL1	15:8	R	0Eh	N/A (Hard-coded)
	Port E Pin widget (0x0E)			
ConL0	7:0	R	0Ch	N/A (Hard-coded)
	Port C Pin widget (0x0C)			

### 7.19.4. ADC0Mux (NID = 17h): OutAmpCap

Reg	Byte 4 (Bits 31:24)	Byte 3 (Bits 23:16)	Byte 2 (Bits 15:8)	Byte 1 (Bits 7:0)
Set				
Get	F0012h			

# 92HD81

## SINGLE CHIP PC AUDIO SYSTEM, CODEC+SPEAKER AMPLIFIER+CAPLESS HP+LDO

Field Name	Bits	R/W	Default	Reset
Mute	31	R	1h	N/A (Hard-coded)
	Mute support: 1 = yes, 0 = no.			
Rsvd3	30:23	R	00h	N/A (Hard-coded)
	Reserved.			
StepSize	22:16	R	05h	N/A (Hard-coded)
	Size of each step in the gain range: 0 to 127 = .25dB to 32dB, in .25dB steps.			
Rsvd2	15	R	0h	N/A (Hard-coded)
	Reserved.			
NumSteps	14:8	R	0Fh	N/A (Hard-coded)
	Number of gains steps (number of possible settings - 1).			
Rsvd1	7	R	0h	N/A (Hard-coded)
	Reserved.			
Offset	6:0	R	00h	N/A (Hard-coded)
	Indicates which step is 0dB			

### 7.19.5. ADC0Mux (NID = 17h): OutAmpLeft

Reg	Byte 4 (Bits 31:24)	Byte 3 (Bits 23:16)	Byte 2 (Bits 15:8)	Byte 1 (Bits 7:0)
Set				3A0h
Get	BA000h			

Field Name	Bits	R/W	Default	Reset
Rsvd2	31:8	R	000000h	N/A (Hard-coded)
	Reserved.			
Mute	7	RW	1h	POR - DAFG - ULR
	Amp mute: 1 = muted, 0 = not muted.			
Rsvd1	6:4	R	0h	N/A (Hard-coded)
	Reserved.			

Field Name	Bits	R/W	Default	Reset
Gain	3:0	RW	0h	POR - DAFG - ULR
Amp gain step number (see OutAmpCap parameter pertaining to this widget).				

#### 7.19.6. ADC0Mux (NID = 17h): OutAmpRight

Reg	Byte 4 (Bits 31:24)	Byte 3 (Bits 23:16)	Byte 2 (Bits 15:8)	Byte 1 (Bits 7:0)
Set				390h
Get	B8000h			

Field Name	Bits	R/W	Default	Reset
Rsvd2	31:8	R	000000h	N/A (Hard-coded)
Reserved.				
Mute	7	RW	1h	POR - DAFG - ULR
Amp mute: 1 = muted, 0 = not muted.				
Rsvd1	6:4	R	0h	N/A (Hard-coded)
Reserved.				
Gain	3:0	RW	0h	POR - DAFG - ULR
Amp gain step number (see OutAmpCap parameter pertaining to this widget).				

#### 7.19.7. ADC0Mux (NID = 17h): ConSelectCtrl

Reg	Byte 4 (Bits 31:24)	Byte 3 (Bits 23:16)	Byte 2 (Bits 15:8)	Byte 1 (Bits 7:0)
Set				701h
Get	F0100h			

Field Name	Bits	R/W	Default	Reset
Rsvd	31:3	R	00000000h	N/A (Hard-coded)
Reserved.				
Index	2:0	RW	0h	POR - DAFG - ULR
Connection select control index.				

**7.19.8. ADC0Mux (NID = 17h): PwrState**

Reg	Byte 4 (Bits 31:24)	Byte 3 (Bits 23:16)	Byte 2 (Bits 15:8)	Byte 1 (Bits 7:0)
Set				705h
Get	F0500h			

Field Name	Bits	R/W	Default	Reset
Rsvd4	31:11	R	000000h	N/A (Hard-coded)
	Reserved.			
SettingsReset	10	R	1h	POR - DAFG - ULR
	Indicates if any persistent settings in this Widget have been reset. Cleared by PwrState 'Get', or a 'Set' to any Verb in this Widget.			
Rsvd3	9	R	0h	N/A (Hard-coded)
	Reserved.			
Error	8	R	0h	POR - DAFG - ULR
	Error indicator: 1 = cannot enter requested power state, 0 = no problem with requested power state.			
Rsvd2	7:6	R	0h	N/A (Hard-coded)
	Reserved.			
Act	5:4	R	3h	POR - DAFG - LR
	Actual power state of this widget.			
Rsvd1	3:2	R	0h	N/A (Hard-coded)
	Reserved.			
Set	1:0	RW	0h	POR - DAFG - LR
	Current power state setting for this widget.			

**7.19.9. ADC0Mux (NID = 17h): EAPDBTLLR**

Reg	Byte 4 (Bits 31:24)	Byte 3 (Bits 23:16)	Byte 2 (Bits 15:8)	Byte 1 (Bits 7:0)
Set				70Ch
Get	F0C00h			



Field Name	Bits	R/W	Default	Reset
Rsvd2	31:3	R	00000000h	N/A (Hard-coded)
	Reserved.			
SwapEn	2	RW	0h	POR - DAFG - ULR
	Swap enable: 1 = L/R swap enabled, 0 = L/R swap disabled.			
Rsvd1	1:0	R	0h	N/A (Hard-coded)
	Reserved.			

### 7.20. ADC1Mux (NID = 18h): WCap

Reg	Byte 4 (Bits 31:24)	Byte 3 (Bits 23:16)	Byte 2 (Bits 15:8)	Byte 1 (Bits 7:0)
Set				
Get	F0009h			

Field Name	Bits	R/W	Default	Reset
Rsvd2	31:24	R	00h	N/A (Hard-coded)
	Reserved.			
Type	23:20	R	3h	N/A (Hard-coded)
Widget type: 0h = Out Converter 1h = In Converter 2h = Summing (Mixer) 3h = Selector (Mux) 4h = Pin Complex 5h = Power 6h = Volume Knob 7h = Beep Generator 8h-Eh = Reserved Fh = Vendor Defined				
Delay	19:16	R	0h	N/A (Hard-coded)
	Number of sample delays through widget.			
Rsvd1	15:12	R	0h	N/A (Hard-coded)
	Reserved.			

# 92HD81

## SINGLE CHIP PC AUDIO SYSTEM, CODEC+SPEAKER AMPLIFIER+CAPLESS HP+LDO

Field Name	Bits	R/W	Default	Reset
SwapCap	11	R	1h	N/A (Hard-coded)
	Left/right swap support: 1 = yes, 0 = no.			
PwrCntrl	10	R	1h	N/A (Hard-coded)
	Power state support: 1 = yes, 0 = no.			
DigitalStrm	9	R	0h	N/A (Hard-coded)
	Digital stream support: 1 = yes (digital), 0 = no (analog).			
ConnList	8	R	1h	N/A (Hard-coded)
	Connection list present: 1 = yes, 0 = no.			
UnsolCap	7	R	0h	N/A (Hard-coded)
	Unsolicited response support: 1 = yes, 0 = no.			
ProcWidget	6	R	0h	N/A (Hard-coded)
	Processing state support: 1 = yes, 0 = no.			
Stripe	5	R	0h	N/A (Hard-coded)
	Striping support: 1 = yes, 0 = no.			
FormatOvrd	4	R	0h	N/A (Hard-coded)
	Stream format override: 1 = yes, 0 = no.			
AmpParamOvrd	3	R	1h	N/A (Hard-coded)
	Amplifier capabilities override: 1 = yes, no.			
OutAmpPrsnt	2	R	1h	N/A (Hard-coded)
	Output amp present: 1 = yes, 0 = no.			
InAmpPrsnt	1	R	0h	N/A (Hard-coded)
	Input amp present: 1 = yes, 0 = no.			
Stereo	0	R	1h	N/A (Hard-coded)
	Stereo stream support: 1 = yes (stereo), 0 = no (mono).			

### 7.20.1. ADC1Mux (NID = 18h): ConLst

Reg	Byte 4 (Bits 31:24)	Byte 3 (Bits 23:16)	Byte 2 (Bits 15:8)	Byte 1 (Bits 7:0)
Set				
Get	F000Eh			

Field Name	Bits	R/W	Default	Reset
Rsvd	31:8	R	000000h	N/A (Hard-coded)
	Reserved.			
LForm	7	R	0h	N/A (Hard-coded)
	Connection list format: 1 = long-form (15-bit) NID entries, 0 = short-form (7-bit) NID entries.			
ConL	6:0	R	07h	N/A (Hard-coded)
	Number of NID entries in connection list.			

**7.20.2. ADC1Mux (NID = 18h): ConLstEntry4**

Reg	Byte 4 (Bits 31:24)	Byte 3 (Bits 23:16)	Byte 2 (Bits 15:8)	Byte 1 (Bits 7:0)
Set				
Get	F0204h			

Field Name	Bits	R/W	Default	Reset
ConL7	31:24	R	00h	N/A (Hard-coded)
	Unused list entry.			
ConL6	23:16	R	0Ah	N/A (Hard-coded)
	Port A Pin widget (0x0A)			
ConL5	15:8	R	12h	N/A (Hard-coded)
	DMic1Vol Selector widget (0x12)			
ConL4	7:0	R	11h	N/A (Hard-coded)
	DMic0 Pin widget (0x11)			

**7.20.3. ADC1Mux (NID = 18h): ConLstEntry0**

Reg	Byte 4 (Bits 31:24)	Byte 3 (Bits 23:16)	Byte 2 (Bits 15:8)	Byte 1 (Bits 7:0)
Set				
Get	F0200h			

Field Name	Bits	R/W	Default	Reset
ConL3	31:24	R	1Bh	N/A (Hard-coded)
	Mixer Summing widget (0x1B)			
ConL2	23:16	R	0Fh	N/A (Hard-coded)
	Port F Pin widget (0x0F)			
ConL1	15:8	R	0Eh	N/A (Hard-coded)
	Port E Pin widget (0x0E)			
ConL0	7:0	R	0Ch	N/A (Hard-coded)
	Port C Pin widget (0x0C)			

#### 7.20.4. ADC1Mux (NID = 18h): OutAmpCap

Reg	Byte 4 (Bits 31:24)	Byte 3 (Bits 23:16)	Byte 2 (Bits 15:8)	Byte 1 (Bits 7:0)
Set				
Get	F0012h			

Field Name	Bits	R/W	Default	Reset
Mute	31	R	1h	N/A (Hard-coded)
	Mute support: 1 = yes, 0 = no.			
Rsvd3	30:23	R	00h	N/A (Hard-coded)
	Reserved.			
StepSize	22:16	R	05h	N/A (Hard-coded)
	Size of each step in the gain range: 0 to 127 = .25dB to 32dB, in .25dB steps.			
Rsvd2	15	R	0h	N/A (Hard-coded)
	Reserved.			
NumSteps	14:8	R	0Fh	N/A (Hard-coded)
	Number of gains steps (number of possible settings - 1).			
Rsvd1	7	R	0h	N/A (Hard-coded)
	Reserved.			

Field Name	Bits	R/W	Default	Reset
Offset	6:0	R	00h	N/A (Hard-coded)
Indicates which step is 0dB				

### 7.20.5. ADC1Mux (NID = 18h): OutAmpLeft

Reg	Byte 4 (Bits 31:24)	Byte 3 (Bits 23:16)	Byte 2 (Bits 15:8)	Byte 1 (Bits 7:0)
Set				3A0h
Get	BA000h			

Field Name	Bits	R/W	Default	Reset
Rsvd2	31:8	R	000000h	N/A (Hard-coded)
Reserved.				
Mute	7	RW	1h	POR - DAFG - ULR
Amp mute: 1 = muted, 0 = not muted.				
Rsvd1	6:4	R	0h	N/A (Hard-coded)
Reserved.				
Gain	3:0	RW	0h	POR - DAFG - ULR
Amp gain step number (see OutAmpCap parameter pertaining to this widget).				

### 7.20.6. ADC1Mux (NID = 18h): OutAmpRight

Reg	Byte 4 (Bits 31:24)	Byte 3 (Bits 23:16)	Byte 2 (Bits 15:8)	Byte 1 (Bits 7:0)
Set				390h
Get	B8000h			

Field Name	Bits	R/W	Default	Reset
Rsvd2	31:8	R	000000h	N/A (Hard-coded)
Reserved.				
Mute	7	RW	1h	POR - DAFG - ULR
Amp mute: 1 = muted, 0 = not muted.				

Field Name	Bits	R/W	Default	Reset
Rsvd1	6:4	R	0h	N/A (Hard-coded)
	Reserved.			
Gain	3:0	RW	0h	POR - DAFG - ULR
	Amp gain step number (see OutAmpCap parameter pertaining to this widget).			

#### 7.20.7. ADC1Mux (NID = 18h): ConSelectCtrl

Reg	Byte 4 (Bits 31:24)	Byte 3 (Bits 23:16)	Byte 2 (Bits 15:8)	Byte 1 (Bits 7:0)
Set				701h
Get	F0100h			

Field Name	Bits	R/W	Default	Reset
Rsvd	31:3	R	00000000h	N/A (Hard-coded)
	Reserved.			
Index	2:0	RW	0h	POR - DAFG - ULR
	Connection select control index.			

#### 7.20.8. ADC1Mux (NID = 18h): PwrState

Reg	Byte 4 (Bits 31:24)	Byte 3 (Bits 23:16)	Byte 2 (Bits 15:8)	Byte 1 (Bits 7:0)
Set				705h
Get	F0500h			

Field Name	Bits	R/W	Default	Reset
Rsvd4	31:11	R	000000h	N/A (Hard-coded)
	Reserved.			
SettingsReset	10	R	1h	POR - DAFG - ULR
	Indicates if any persistent settings in this Widget have been reset. Cleared by PwrState 'Get', or a 'Set' to any Verb in this Widget.			
Rsvd3	9	R	0h	N/A (Hard-coded)
	Reserved.			

Field Name	Bits	R/W	Default	Reset
Error	8	R	0h	POR - DAFG - ULR
	Error indicator: 1 = cannot enter requested power state, 0 = no problem with requested power state.			
Rsvd2	7:6	R	0h	N/A (Hard-coded)
	Reserved.			
Act	5:4	R	3h	POR - DAFG - LR
	Actual power state of this widget.			
Rsvd1	3:2	R	0h	N/A (Hard-coded)
	Reserved.			
Set	1:0	RW	0h	POR - DAFG - LR
	Current power state setting for this widget.			

#### 7.20.9. ADC1Mux (NID = 18h): EAPDBTLLR

Reg	Byte 4 (Bits 31:24)	Byte 3 (Bits 23:16)	Byte 2 (Bits 15:8)	Byte 1 (Bits 7:0)
Set				70Ch
Get	F0C00h			

Field Name	Bits	R/W	Default	Reset
Rsvd2	31:3	R	00000000h	N/A (Hard-coded)
	Reserved.			
SwapEn	2	RW	0h	POR - DAFG - ULR
	Swap enable: 1 = L/R swap enabled, 0 = L/R swap disabled.			
Rsvd1	1:0	R	0h	N/A (Hard-coded)
	Reserved.			

#### 7.21. MonoMux (NID = 19h): WCap

Reg	Byte 4 (Bits 31:24)	Byte 3 (Bits 23:16)	Byte 2 (Bits 15:8)	Byte 1 (Bits 7:0)
Set				
Get	F0009h			

# 92HD81

## SINGLE CHIP PC AUDIO SYSTEM, CODEC+SPEAKER AMPLIFIER+CAPLESS HP+LDO

Field Name	Bits	R/W	Default	Reset
Rsvd2	31:24	R	00h	N/A (Hard-coded)
	Reserved.			
Type	23:20	R	3h	N/A (Hard-coded)
	Widget type: 0h = Out Converter 1h = In Converter 2h = Summing (Mixer) 3h = Selector (Mux) 4h = Pin Complex 5h = Power 6h = Volume Knob 7h = Beep Generator 8h-Eh = Reserved Fh = Vendor Defined			
Delay	19:16	R	0h	N/A (Hard-coded)
	Number of sample delays through widget.			
Rsvd1	15:12	R	0h	N/A (Hard-coded)
	Reserved.			
SwapCap	11	R	0h	N/A (Hard-coded)
	Left/right swap support: 1 = yes, 0 = no.			
PwrCntrl	10	R	1h	N/A (Hard-coded)
	Power state support: 1 = yes, 0 = no.			
Dig	9	R	0h	N/A (Hard-coded)
	Digital stream support: 1 = yes (digital), 0 = no (analog).			
ConnList	8	R	1h	N/A (Hard-coded)
	Connection list present: 1 = yes, 0 = no.			
UnSolCap	7	R	0h	N/A (Hard-coded)
	Unsolicited response support: 1 = yes, 0 = no.			
ProcWidget	6	R	0h	N/A (Hard-coded)
	Processing state support: 1 = yes, 0 = no.			
Stripe	5	R	0h	N/A (Hard-coded)
	Striping support: 1 = yes, 0 = no.			



Field Name	Bits	R/W	Default	Reset
FormatOvrD	4	R	0h	N/A (Hard-coded)
	Stream format override: 1 = yes, 0 = no.			
AmpParOvrD	3	R	0h	N/A (Hard-coded)
	Amplifier capabilities override: 1 = yes, no.			
OutAmpPrsnt	2	R	0h	N/A (Hard-coded)
	Output amp present: 1 = yes, 0 = no.			
InAmpPrsnt	1	R	0h	N/A (Hard-coded)
	Input amp present: 1 = yes, 0 = no.			
Stereo	0	R	1h	N/A (Hard-coded)
	Stereo stream support: 1 = yes (stereo), 0 = no (mono).			

### 7.21.1. MonoMux (NID = 19h): ConLst

Reg	Byte 4 (Bits 31:24)	Byte 3 (Bits 23:16)	Byte 2 (Bits 15:8)	Byte 1 (Bits 7:0)
Set				
Get	F000Eh			

Field Name	Bits	R/W	Default	Reset
Rsvd	31:8	R	000000h	N/A (Hard-coded)
	Reserved.			
LForm	7	R	0h	N/A (Hard-coded)
	Connection list format: 1 = long-form (15-bit) NID entries, 0 = short-form (7-bit) NID entries.			
ConL	6:0	R	03h	N/A (Hard-coded)
	Number of NID entries in connection list.			

### 7.21.2. MonoMux (NID = 19h): ConLstEntry0

Reg	Byte 4 (Bits 31:24)	Byte 3 (Bits 23:16)	Byte 2 (Bits 15:8)	Byte 1 (Bits 7:0)
Set				
Get	F0200h			

Field Name	Bits	R/W	Default	Reset
ConL3	31:24	R	00h	N/A (Hard-coded)
	DAC2 Converter widget (0x22)			
ConL2	23:16	R	1Ch	N/A (Hard-coded)
	MixerOutVol Selector widget (0x1C)			
ConL1	15:8	R	14h	N/A (Hard-coded)
	DAC1 Converter widget (0x14)			
ConL0	7:0	R	13h	N/A (Hard-coded)
	DAC0 Converter widget (0x13)			

### 7.21.3. MonoMux (NID = 19h): ConSelectCtrl

Reg	Byte 4 (Bits 31:24)	Byte 3 (Bits 23:16)	Byte 2 (Bits 15:8)	Byte 1 (Bits 7:0)
Set				701h
Get	F0100h			

Field Name	Bits	R/W	Default	Reset
Rsvd	31:2	R	0000000h	N/A (Hard-coded)
	Reserved.			
Index	1:0	RW	0h	POR - DAFG - ULR
	Connection select control index.			

### 7.21.4. MonoMux (NID = 19h): PwrState

Reg	Byte 4 (Bits 31:24)	Byte 3 (Bits 23:16)	Byte 2 (Bits 15:8)	Byte 1 (Bits 7:0)
Set				705h
Get	F0500h			

Field Name	Bits	R/W	Default	Reset
Rsvd4	31:11	R	000000h	N/A (Hard-coded)
	Reserved.			

Field Name	Bits	R/W	Default	Reset
SettingsReset	10	R	1h	POR - DAFG - ULR
	Indicates if any persistent settings in this Widget have been reset. Cleared by PwrState 'Get', or a 'Set' to any Verb in this Widget.			
Rsvd3	9	R	0h	N/A (Hard-coded)
	Reserved.			
Error	8	R	0h	POR - DAFG - ULR
	Error indicator: 1 = cannot enter requested power state, 0 = no problem with requested power state.			
Rsvd2	7:6	R	0h	N/A (Hard-coded)
	Reserved.			
Act	5:4	R	3h	POR - DAFG - LR
	Actual power state of this widget.			
Rsvd1	3:2	R	0h	N/A (Hard-coded)
	Reserved.			
Set	1:0	RW	0h	POR - DAFG - LR
	Current power state setting for this widget.			

**7.22. MonoMix (NID = 1Ah): WCap**

Reg	Byte 4 (Bits 31:24)	Byte 3 (Bits 23:16)	Byte 2 (Bits 15:8)	Byte 1 (Bits 7:0)
Set				
Get	F0009h			

Field Name	Bits	R/W	Default	Reset
Rsvd2	31:24	R	00h	N/A (Hard-coded)
	Reserved.			

# 92HD81

## SINGLE CHIP PC AUDIO SYSTEM, CODEC+SPEAKER AMPLIFIER+CAPLESS HP+LDO

Field Name	Bits	R/W	Default	Reset
Type	23:20	R	2h	N/A (Hard-coded)
Widget type: 0h = Out Converter 1h = In Converter 2h = Summing (Mixer) 3h = Selector (Mux) 4h = Pin Complex 5h = Power 6h = Volume Knob 7h = Beep Generator 8h-Eh = Reserved Fh = Vendor Defined				
Delay	19:16	R	0h	N/A (Hard-coded)
Number of sample delays through widget.				
Rsvd1	15:12	R	0h	N/A (Hard-coded)
Reserved.				
SwapCap	11	R	0h	N/A (Hard-coded)
Left/right swap support: 1 = yes, 0 = no.				
PwrCntrl	10	R	1h	N/A (Hard-coded)
Power state support: 1 = yes, 0 = no.				
Dig	9	R	0h	N/A (Hard-coded)
Digital stream support: 1 = yes (digital), 0 = no (analog).				
ConnList	8	R	1h	N/A (Hard-coded)
Connection list present: 1 = yes, 0 = no.				
UnSolCap	7	R	0h	N/A (Hard-coded)
Unsolicited response support: 1 = yes, 0 = no.				
ProcWidget	6	R	0h	N/A (Hard-coded)
Processing state support: 1 = yes, 0 = no.				
Stripe	5	R	0h	N/A (Hard-coded)
Striping support: 1 = yes, 0 = no.				
FormatOvrd	4	R	0h	N/A (Hard-coded)
Stream format override: 1 = yes, 0 = no.				

Field Name	Bits	R/W	Default	Reset
AmpParOvr	3	R	0h	N/A (Hard-coded)
Amplifier capabilities override: 1 = yes, no.				
OutAmpPrsnt	2	R	0h	N/A (Hard-coded)
Output amp present: 1 = yes, 0 = no.				
InAmpPrsnt	1	R	0h	N/A (Hard-coded)
Input amp present: 1 = yes, 0 = no.				
Stereo	0	R	0h	N/A (Hard-coded)
Stereo stream support: 1 = yes (stereo), 0 = no (mono).				

### 7.22.1. MonoMix (NID = 1Ah): ConLst

Reg	Byte 4 (Bits 31:24)	Byte 3 (Bits 23:16)	Byte 2 (Bits 15:8)	Byte 1 (Bits 7:0)
Set				
Get	F000Eh			

Field Name	Bits	R/W	Default	Reset
Rsvd	31:8	R	000000h	N/A (Hard-coded)
Reserved.				
LForm	7	R	0h	N/A (Hard-coded)
Connection list format: 1 = long-form (15-bit) NID entries, 0 = short-form (7-bit) NID entries.				
ConL	6:0	R	01h	N/A (Hard-coded)
Number of NID entries in connection list.				

### 7.22.2. MonoMix (NID = 1Ah): ConLstEntry0

Reg	Byte 4 (Bits 31:24)	Byte 3 (Bits 23:16)	Byte 2 (Bits 15:8)	Byte 1 (Bits 7:0)
Set				
Get	F0200h			

Field Name	Bits	R/W	Default	Reset
ConL3	31:24	R	00h	N/A (Hard-coded)
	Unused list entry.			
ConL2	23:16	R	00h	N/A (Hard-coded)
	Unused list entry.			
ConL1	15:8	R	00h	N/A (Hard-coded)
	Unused list entry.			
ConL0	7:0	R	19h	N/A (Hard-coded)
	MonoMux Selector widget (0x19)			

### 7.22.3. MonoMix (NID = 1Ah): PwrState

Reg	Byte 4 (Bits 31:24)	Byte 3 (Bits 23:16)	Byte 2 (Bits 15:8)	Byte 1 (Bits 7:0)
Set				705h
Get	F0500h			

Field Name	Bits	R/W	Default	Reset
Rsvd4	31:11	R	000000h	N/A (Hard-coded)
	Reserved.			
SettingsReset	10	R	1h	POR - DAFG - ULR
	Indicates if any persistent settings in this Widget have been reset. Cleared by PwrState 'Get', or a 'Set' to any Verb in this Widget.			
Rsvd3	9	R	0h	N/A (Hard-coded)
	Reserved.			
Error	8	R	0h	POR - DAFG - ULR
	Error indicator: 1 = cannot enter requested power state, 0 = no problem with requested power state.			
Rsvd2	7:6	R	0h	N/A (Hard-coded)
	Reserved.			
Act	5:4	R	3h	POR - DAFG - LR
	Actual power state of this widget.			

Field Name	Bits	R/W	Default	Reset
Rsvd1	3:2	R	0h	N/A (Hard-coded)
	Reserved.			
Set	1:0	RW	0h	POR - DAFG - LR
	Current power state setting for this widget.			

### 7.23. Mixer (NID = 1Bh): WCap

Reg	Byte 4 (Bits 31:24)	Byte 3 (Bits 23:16)	Byte 2 (Bits 15:8)	Byte 1 (Bits 7:0)
Set				
Get	F0009h			

Field Name	Bits	R/W	Default	Reset
Rsvd2	31:24	R	00h	N/A (Hard-coded)
	Reserved.			
Type	23:20	R	2h	N/A (Hard-coded)
Widget type: 0h = Out Converter 1h = In Converter 2h = Summing (Mixer) 3h = Selector (Mux) 4h = Pin Complex 5h = Power 6h = Volume Knob 7h = Beep Generator 8h-Eh = Reserved Fh = Vendor Defined				
Delay	19:16	R	0h	N/A (Hard-coded)
	Number of sample delays through widget.			
Rsvd1	15:12	R	0h	N/A (Hard-coded)
	Reserved.			
SwapCap	11	R	0h	N/A (Hard-coded)
	Left/right swap support: 1 = yes, 0 = no.			
PwrCntrl	10	R	1h	N/A (Hard-coded)
	Power state support: 1 = yes, 0 = no.			

# 92HD81

## SINGLE CHIP PC AUDIO SYSTEM, CODEC+SPEAKER AMPLIFIER+CAPLESS HP+LDO

Field Name	Bits	R/W	Default	Reset
Dig	9	R	0h	N/A (Hard-coded)
	Digital stream support: 1 = yes (digital), 0 = no (analog).			
ConnList	8	R	1h	N/A (Hard-coded)
	Connection list present: 1 = yes, 0 = no.			
UnSolCap	7	R	0h	N/A (Hard-coded)
	Unsolicited response support: 1 = yes, 0 = no.			
ProcWidget	6	R	0h	N/A (Hard-coded)
	Processing state support: 1 = yes, 0 = no.			
Stripe	5	R	0h	N/A (Hard-coded)
	Striping support: 1 = yes, 0 = no.			
FormatOvrd	4	R	0h	N/A (Hard-coded)
	Stream format override: 1 = yes, 0 = no.			
AmpParOvrd	3	R	1h	N/A (Hard-coded)
	Amplifier capabilities override: 1 = yes, no.			
OutAmpPrsnt	2	R	0h	N/A (Hard-coded)
	Output amp present: 1 = yes, 0 = no.			
InAmpPrsnt	1	R	1h	N/A (Hard-coded)
	Input amp present: 1 = yes, 0 = no.			
Stereo	0	R	1h	N/A (Hard-coded)
	Stereo stream support: 1 = yes (stereo), 0 = no (mono).			

### 7.23.1. Mixer (NID = 1Bh): InAmpCap

Reg	Byte 4 (Bits 31:24)	Byte 3 (Bits 23:16)	Byte 2 (Bits 15:8)	Byte 1 (Bits 7:0)
Set				
Get	F000Dh			



# 92HD81

## SINGLE CHIP PC AUDIO SYSTEM, CODEC+SPEAKER AMPLIFIER+CAPLESS HP+LDO

Field Name	Bits	R/W	Default	Reset
Mute	31	R	1h	N/A (Hard-coded)
	Mute support: 1 = yes, 0 = no.			
Rsvd3	30:23	R	00h	N/A (Hard-coded)
	Reserved.			
StepSize	22:16	R	05h	N/A (Hard-coded)
	Size of each step in the gain range: 0 to 127 = .25dB to 32dB, in .25dB steps.			
Rsvd2	15	R	0h	N/A (Hard-coded)
	Reserved.			
NumSteps	14:8	R	1Fh	N/A (Hard-coded)
	Number of gains steps (number of possible settings - 1).			
Rsvd1	7	R	0h	N/A (Hard-coded)
	Reserved.			
Offset	6:0	R	17h	N/A (Hard-coded)
	Indicates which step is 0dB			

### 7.23.2. Mixer (NID = 1Bh): ConLst

Reg	Byte 4 (Bits 31:24)	Byte 3 (Bits 23:16)	Byte 2 (Bits 15:8)	Byte 1 (Bits 7:0)
Set				
Get	F000Eh			

Field Name	Bits	R/W	Default	Reset
Rsvd	31:8	R	000000h	N/A (Hard-coded)
	Reserved.			
LForm	7	R	0h	N/A (Hard-coded)
	Connection list format: 1 = long-form (15-bit) NID entries, 0 = short-form (7-bit) NID entries.			
ConL	6:0	R	06h	N/A (Hard-coded)
	Number of NID entries in connection list.			

## 7.23.3. Mixer (NID = 1Bh): ConLstEntry4

Reg	Byte 4 (Bits 31:24)	Byte 3 (Bits 23:16)	Byte 2 (Bits 15:8)	Byte 1 (Bits 7:0)
Set				
Get	F0204h			

Field Name	Bits	R/W	Default	Reset
ConL7	31:24	R	00h	N/A (Hard-coded)
	Unused list entry.			
ConL6	23:16	R	00h	N/A (Hard-coded)
	Unused list entry.			
ConL5	15:8	R	0Ah	N/A (Hard-coded)
	Port A Pin widget (0x0A). Uses InAmpLeft5/InAmpRight5 controls.			
ConL4	7:0	R	14h	N/A (Hard-coded)
	DAC1 Converter widget (0x14). Uses InAmpLeft4/InAmpRight4 controls.			

## 7.23.4. Mixer (NID = 1Bh): ConLstEntry0

Reg	Byte 4 (Bits 31:24)	Byte 3 (Bits 23:16)	Byte 2 (Bits 15:8)	Byte 1 (Bits 7:0)
Set				
Get	F0200h			

Field Name	Bits	R/W	Default	Reset
ConL3	31:24	R	13h	N/A (Hard-coded)
	DAC0 Converter widget (0x13). Uses InAmpLeft3/InAmpRight3 controls.			
ConL2	23:16	R	0Fh	N/A (Hard-coded)
	Port F Pin widget (0x0F). Uses InAmpLeft2/InAmpRight2 controls.			
ConL1	15:8	R	0Eh	N/A (Hard-coded)
	Port E Pin widget (0x0E). Uses InAmpLeft1/InAmpRight1 controls.			
ConL0	7:0	R	0Ch	N/A (Hard-coded)
	Port C Pin widget (0x0C). Uses InAmpLeft0/InAmpRight0 controls.			

**7.23.5. Mixer (NID = 1Bh): InAmpLeft0**

Reg	Byte 4 (Bits 31:24)	Byte 3 (Bits 23:16)	Byte 2 (Bits 15:8)	Byte 1 (Bits 7:0)
Set				360h
Get	B2000h			

Field Name	Bits	R/W	Default	Reset
Rsvd2	31:8	R	000000h	N/A (Hard-coded)
	Reserved.			
Mute	7	RW	1h	POR - DAFG - ULR
	Amp mute: 1 = muted, 0 = not muted.			
Rsvd1	6:5	R	0h	N/A (Hard-coded)
	Reserved.			
Gain	4:0	RW	17h	POR - DAFG - ULR
	Amp gain step number (see InAmpCap parameter pertaining to this widget).			

**7.23.6. Mixer (NID = 1Bh): InAmpRight0**

Reg	Byte 4 (Bits 31:24)	Byte 3 (Bits 23:16)	Byte 2 (Bits 15:8)	Byte 1 (Bits 7:0)
Set				350h
Get	B0000h			

Field Name	Bits	R/W	Default	Reset
Rsvd2	31:8	R	000000h	N/A (Hard-coded)
	Reserved.			
Mute	7	RW	1h	POR - DAFG - ULR
	Amp mute: 1 = muted, 0 = not muted.			
Rsvd1	6:5	R	0h	N/A (Hard-coded)
	Reserved.			
Gain	4:0	RW	17h	POR - DAFG - ULR
	Amp gain step number (see InAmpCap parameter pertaining to this widget).			

**7.23.7. Mixer (NID = 1Bh): InAmpLeft1**

Reg	Byte 4 (Bits 31:24)	Byte 3 (Bits 23:16)	Byte 2 (Bits 15:8)	Byte 1 (Bits 7:0)
Set				361h
Get	B2001h			

Field Name	Bits	R/W	Default	Reset
Rsvd2	31:8	R	000000h	N/A (Hard-coded)
	Reserved.			
Mute	7	RW	1h	POR - DAFG - ULR
	Amp mute: 1 = muted, 0 = not muted.			
Rsvd1	6:5	R	0h	N/A (Hard-coded)
	Reserved.			
Gain	4:0	RW	17h	POR - DAFG - ULR
	Amp gain step number (see InAmpCap parameter pertaining to this widget).			

**7.23.8. Mixer (NID = 1Bh): InAmpRight1**

Reg	Byte 4 (Bits 31:24)	Byte 3 (Bits 23:16)	Byte 2 (Bits 15:8)	Byte 1 (Bits 7:0)
Set				351h
Get	B0001h			

Field Name	Bits	R/W	Default	Reset
Rsvd2	31:8	R	000000h	N/A (Hard-coded)
	Reserved.			
Mute	7	RW	1h	POR - DAFG - ULR
	Amp mute: 1 = muted, 0 = not muted.			
Rsvd1	6:5	R	0h	N/A (Hard-coded)
	Reserved.			
Gain	4:0	RW	17h	POR - DAFG - ULR
	Amp gain step number (see InAmpCap parameter pertaining to this widget).			

**7.23.9. Mixer (NID = 1Bh): InAmpLeft2**

Reg	Byte 4 (Bits 31:24)	Byte 3 (Bits 23:16)	Byte 2 (Bits 15:8)	Byte 1 (Bits 7:0)
Set				362h
Get	B2002h			

Field Name	Bits	R/W	Default	Reset
Rsvd2	31:8	R	000000h	N/A (Hard-coded)
	Reserved.			
Mute	7	RW	1h	POR - DAFG - ULR
	Amp mute: 1 = muted, 0 = not muted.			
Rsvd1	6:5	R	0h	N/A (Hard-coded)
	Reserved.			
Gain	4:0	RW	17h	POR - DAFG - ULR
	Amp gain step number (see InAmpCap parameter pertaining to this widget).			

**7.23.10. Mixer (NID = 1Bh): InAmpRight2**

Reg	Byte 4 (Bits 31:24)	Byte 3 (Bits 23:16)	Byte 2 (Bits 15:8)	Byte 1 (Bits 7:0)
Set				352h
Get	B0002h			

Field Name	Bits	R/W	Default	Reset
Rsvd2	31:8	R	000000h	N/A (Hard-coded)
	Reserved.			
Mute	7	RW	1h	POR - DAFG - ULR
	Amp mute: 1 = muted, 0 = not muted.			
Rsvd1	6:5	R	0h	N/A (Hard-coded)
	Reserved.			
Gain	4:0	RW	17h	POR - DAFG - ULR
	Amp gain step number (see InAmpCap parameter pertaining to this widget).			

**7.23.11. Mixer (NID = 1Bh): InAmpLeft3**

Reg	Byte 4 (Bits 31:24)	Byte 3 (Bits 23:16)	Byte 2 (Bits 15:8)	Byte 1 (Bits 7:0)
Set				363h
Get	B2003h			

Field Name	Bits	R/W	Default	Reset
Rsvd2	31:8	R	000000h	N/A (Hard-coded)
	Reserved.			
Mute	7	RW	1h	POR - DAFG - ULR
	Amp mute: 1 = muted, 0 = not muted.			
Rsvd1	6:5	R	0h	N/A (Hard-coded)
	Reserved.			
Gain	4:0	RW	17h	POR - DAFG - ULR
	Amp gain step number (see InAmpCap parameter pertaining to this widget).			

**7.23.12. Mixer (NID = 1Bh): InAmpRight3**

Reg	Byte 4 (Bits 31:24)	Byte 3 (Bits 23:16)	Byte 2 (Bits 15:8)	Byte 1 (Bits 7:0)
Set				353h
Get	B0003h			

Field Name	Bits	R/W	Default	Reset
Rsvd2	31:8	R	000000h	N/A (Hard-coded)
	Reserved.			
Mute	7	RW	1h	POR - DAFG - ULR
	Amp mute: 1 = muted, 0 = not muted.			
Rsvd1	6:5	R	0h	N/A (Hard-coded)
	Reserved.			
Gain	4:0	RW	17h	POR - DAFG - ULR
	Amp gain step number (see InAmpCap parameter pertaining to this widget).			

**7.23.13. Mixer (NID = 1Bh): InAmpLeft4**

Reg	Byte 4 (Bits 31:24)	Byte 3 (Bits 23:16)	Byte 2 (Bits 15:8)	Byte 1 (Bits 7:0)
Set				364h
Get	B2004h			

Field Name	Bits	R/W	Default	Reset
Rsvd2	31:8	R	000000h	N/A (Hard-coded)
	Reserved.			
Mute	7	RW	1h	POR - DAFG - ULR
	Amp mute: 1 = muted, 0 = not muted.			
Rsvd1	6:5	R	0h	N/A (Hard-coded)
	Reserved.			
Gain	4:0	RW	17h	POR - DAFG - ULR
	Amp gain step number (see InAmpCap parameter pertaining to this widget).			

**7.23.14. Mixer (NID = 1Bh): InAmpRight4**

Reg	Byte 4 (Bits 31:24)	Byte 3 (Bits 23:16)	Byte 2 (Bits 15:8)	Byte 1 (Bits 7:0)
Set				354h
Get	B0004h			

Field Name	Bits	R/W	Default	Reset
Rsvd2	31:8	R	000000h	N/A (Hard-coded)
	Reserved.			
Mute	7	RW	1h	POR - DAFG - ULR
	Amp mute: 1 = muted, 0 = not muted.			
Rsvd1	6:5	R	0h	N/A (Hard-coded)
	Reserved.			
Gain	4:0	RW	17h	POR - DAFG - ULR
	Amp gain step number (see InAmpCap parameter pertaining to this widget).			

**7.23.15. Mixer (NID = 1Bh): InAmpLeft5**

Reg	Byte 4 (Bits 31:24)	Byte 3 (Bits 23:16)	Byte 2 (Bits 15:8)	Byte 1 (Bits 7:0)
Set				365h
Get	B2005h			

Field Name	Bits	R/W	Default	Reset
Rsvd2	31:8	R	000000h	N/A (Hard-coded)
	Reserved.			
Mute	7	RW	1h	POR - DAFG - ULR
	Amp mute: 1 = muted, 0 = not muted.			
Rsvd1	6:5	R	0h	N/A (Hard-coded)
	Reserved.			
Gain	4:0	RW	17h	POR - DAFG - ULR
	Amp gain step number (see InAmpCap parameter pertaining to this widget).			

**7.23.16. Mixer (NID = 1Bh): InAmpRight5**

Reg	Byte 4 (Bits 31:24)	Byte 3 (Bits 23:16)	Byte 2 (Bits 15:8)	Byte 1 (Bits 7:0)
Set				355h
Get	B0005h			

Field Name	Bits	R/W	Default	Reset
Rsvd2	31:8	R	000000h	N/A (Hard-coded)
	Reserved.			
Mute	7	RW	1h	POR - DAFG - ULR
	Amp mute: 1 = muted, 0 = not muted.			
Rsvd1	6:5	R	0h	N/A (Hard-coded)
	Reserved.			
Gain	4:0	RW	17h	POR - DAFG - ULR
	Amp gain step number (see InAmpCap parameter pertaining to this widget).			



**7.23.17. Mixer (NID = 1Bh): PwrState**

Reg	Byte 4 (Bits 31:24)	Byte 3 (Bits 23:16)	Byte 2 (Bits 15:8)	Byte 1 (Bits 7:0)
Set				705h
Get	F0500h			

Field Name	Bits	R/W	Default	Reset
Rsvd4	31:11	R	000000h	N/A (Hard-coded)
	Reserved.			
SettingsReset	10	R	1h	POR - DAFG - ULR
	Indicates if any persistent settings in this Widget have been reset. Cleared by PwrState 'Get', or a 'Set' to any Verb in this Widget.			
Rsvd3	9	R	0h	N/A (Hard-coded)
	Reserved.			
Error	8	R	0h	POR - DAFG - ULR
	Error indicator: 1 = cannot enter requested power state, 0 = no problem with requested power state.			
Rsvd2	7:6	R	0h	N/A (Hard-coded)
	Reserved.			
Act	5:4	R	3h	POR - DAFG - LR
	Actual power state of this widget.			
Rsvd1	3:2	R	0h	N/A (Hard-coded)
	Reserved.			
Set	1:0	RW	0h	POR - DAFG - LR
	Current power state setting for this widget.			

**7.24. MixerOutVol (NID = 1Ch): WCap**

Reg	Byte 4 (Bits 31:24)	Byte 3 (Bits 23:16)	Byte 2 (Bits 15:8)	Byte 1 (Bits 7:0)
Set				
Get	F0009h			

# 92HD81

## SINGLE CHIP PC AUDIO SYSTEM, CODEC+SPEAKER AMPLIFIER+CAPLESS HP+LDO

Field Name	Bits	R/W	Default	Reset
Rsvd2	31:24	R	00h	N/A (Hard-coded)
	Reserved.			
Type	23:20	R	3h	N/A (Hard-coded)
	Widget type: 0h = Out Converter 1h = In Converter 2h = Summing (Mixer) 3h = Selector (Mux) 4h = Pin Complex 5h = Power 6h = Volume Knob 7h = Beep Generator 8h-Eh = Reserved Fh = Vendor Defined			
Delay	19:16	R	0h	N/A (Hard-coded)
	Number of sample delays through widget.			
Rsvd1	15:12	R	0h	N/A (Hard-coded)
	Reserved.			
SwapCap	11	R	0h	N/A (Hard-coded)
	Left/right swap support: 1 = yes, 0 = no.			
PwrCntrl	10	R	1h	N/A (Hard-coded)
	Power state support: 1 = yes, 0 = no.			
Dig	9	R	0h	N/A (Hard-coded)
	Digital stream support: 1 = yes (digital), 0 = no (analog).			
ConnList	8	R	1h	N/A (Hard-coded)
	Connection list present: 1 = yes, 0 = no.			
UnSolCap	7	R	0h	N/A (Hard-coded)
	Unsolicited response support: 1 = yes, 0 = no.			
ProcWidget	6	R	0h	N/A (Hard-coded)
	Processing state support: 1 = yes, 0 = no.			
Stripe	5	R	0h	N/A (Hard-coded)
	Striping support: 1 = yes, 0 = no.			

Field Name	Bits	R/W	Default	Reset
FormatOvrd	4	R	0h	N/A (Hard-coded)
	Stream format override: 1 = yes, 0 = no.			
AmpParOvrd	3	R	1h	N/A (Hard-coded)
	Amplifier capabilities override: 1 = yes, no.			
OutAmpPrsnt	2	R	1h	N/A (Hard-coded)
	Output amp present: 1 = yes, 0 = no.			
InAmpPrsnt	1	R	0h	N/A (Hard-coded)
	Input amp present: 1 = yes, 0 = no.			
Stereo	0	R	1h	N/A (Hard-coded)
	Stereo stream support: 1 = yes (stereo), 0 = no (mono).			

#### 7.24.1. MixerOutVol (NID = 1Ch): ConLst

Reg	Byte 4 (Bits 31:24)	Byte 3 (Bits 23:16)	Byte 2 (Bits 15:8)	Byte 1 (Bits 7:0)
Set				
Get	F000Eh			

Field Name	Bits	R/W	Default	Reset
Rsvd	31:8	R	000000h	N/A (Hard-coded)
	Reserved.			
LForm	7	R	0h	N/A (Hard-coded)
	Connection list format: 1 = long-form (15-bit) NID entries, 0 = short-form (7-bit) NID entries.			
ConL	6:0	R	01h	N/A (Hard-coded)
	Number of NID entries in connection list.			

#### 7.24.2. MixerOutVol (NID = 1Ch): ConLstEntry0

Reg	Byte 4 (Bits 31:24)	Byte 3 (Bits 23:16)	Byte 2 (Bits 15:8)	Byte 1 (Bits 7:0)
Set				
Get	F0200h			

Field Name	Bits	R/W	Default	Reset
ConL3	31:24	R	00h	N/A (Hard-coded)
	Unused list entry.			
ConL2	23:16	R	00h	N/A (Hard-coded)
	Unused list entry.			
ConL1	15:8	R	00h	N/A (Hard-coded)
	Unused list entry.			
ConL0	7:0	R	1Bh	N/A (Hard-coded)
	Mixer Summing widget (0x1B)			

### 7.24.3. MixerOutVol (NID = 1Ch): OutAmpCap

Reg	Byte 4 (Bits 31:24)	Byte 3 (Bits 23:16)	Byte 2 (Bits 15:8)	Byte 1 (Bits 7:0)
Set				
Get	F0012h			

Field Name	Bits	R/W	Default	Reset
Mute	31	R	1h	N/A (Hard-coded)
	Mute support: 1 = yes, 0 = no.			
Rsvd3	30:23	R	00h	N/A (Hard-coded)
	Reserved.			
StepSize	22:16	R	05h	N/A (Hard-coded)
	Size of each step in the gain range: 0 to 127 = .25dB to 32dB, in .25dB steps.			
Rsvd2	15	R	0h	N/A (Hard-coded)
	Reserved.			
NumSteps	14:8	R	1Fh	N/A (Hard-coded)
	Number of gains steps (number of possible settings - 1).			
Rsvd1	7	R	0h	N/A (Hard-coded)
	Reserved.			

**92HD81****SINGLE CHIP PC AUDIO SYSTEM, CODEC+SPEAKER AMPLIFIER+CAPLESS HP+LDO**

Field Name	Bits	R/W	Default	Reset
Offset	6:0	R	1Fh	N/A (Hard-coded)
	Indicates which step is 0dB			

**7.24.4. MixerOutVol (NID = 1Ch): OutAmpLeft**

Reg	Byte 4 (Bits 31:24)	Byte 3 (Bits 23:16)	Byte 2 (Bits 15:8)	Byte 1 (Bits 7:0)
Set				3A0h
Get	BA000h			

Field Name	Bits	R/W	Default	Reset
Rsvd2	31:8	R	000000h	N/A (Hard-coded)
	Reserved.			
Mute	7	RW	1h	POR - DAFG - ULR
	Amp mute: 1 = muted, 0 = not muted.			
Rsvd1	6:5	R	0h	N/A (Hard-coded)
	Reserved.			
Gain	4:0	RW	1Fh	POR - DAFG - ULR
	Amp gain step number (see OutAmpCap parameter pertaining to this widget).			

**7.24.5. MixerOutVol (NID = 1Ch): OutAmpRight**

Reg	Byte 4 (Bits 31:24)	Byte 3 (Bits 23:16)	Byte 2 (Bits 15:8)	Byte 1 (Bits 7:0)
Set				390h
Get	B8000h			

Field Name	Bits	R/W	Default	Reset
Rsvd2	31:8	R	000000h	N/A (Hard-coded)
	Reserved.			
Mute	7	RW	1h	POR - DAFG - ULR
	Amp mute: 1 = muted, 0 = not muted.			

Field Name	Bits	R/W	Default	Reset
Rsvd1	6:5	R	0h	N/A (Hard-coded)
	Reserved.			
Gain	4:0	RW	1Fh	POR - DAFG - ULR
	Amp gain step number (see OutAmpCap parameter pertaining to this widget).			

#### 7.24.6. MixerOutVol (NID = 1Ch): PwrState

Reg	Byte 4 (Bits 31:24)	Byte 3 (Bits 23:16)	Byte 2 (Bits 15:8)	Byte 1 (Bits 7:0)
Set				705h
Get	F0500h			

Field Name	Bits	R/W	Default	Reset
Rsvd4	31:11	R	000000h	N/A (Hard-coded)
	Reserved.			
SettingsReset	10	R	1h	POR - DAFG - ULR
	Indicates if any persistent settings in this Widget have been reset. Cleared by PwrState 'Get', or a 'Set' to any Verb in this Widget.			
Rsvd3	9	R	0h	N/A (Hard-coded)
	Reserved.			
Error	8	R	0h	POR - DAFG - ULR
	Error indicator: 1 = cannot enter requested power state, 0 = no problem with requested power state.			
Rsvd2	7:6	R	0h	N/A (Hard-coded)
	Reserved.			
Act	5:4	R	3h	POR - DAFG - LR
	Actual power state of this widget.			
Rsvd1	3:2	R	0h	N/A (Hard-coded)
	Reserved.			
Set	1:0	RW	0h	POR - DAFG - LR
	Current power state setting for this widget.			

## 7.25. SPDIFOut0 (NID = 1Dh): WCap

Reg	Byte 4 (Bits 31:24)	Byte 3 (Bits 23:16)	Byte 2 (Bits 15:8)	Byte 1 (Bits 7:0)
Set				
Get	F0009h			

Field Name	Bits	R/W	Default	Reset
Rsvd2	31:24	R	00h	N/A (Hard-coded)
	Reserved.			
Type	23:20	R	0h	N/A (Hard-coded)
	Widget type: 0h = Out Converter 1h = In Converter 2h = Summing (Mixer) 3h = Selector (Mux) 4h = Pin Complex 5h = Power 6h = Volume Knob 7h = Beep Generator 8h-Eh = Reserved Fh = Vendor Defined			
Delay	19:16	R	4h	N/A (Hard-coded)
	Number of sample delays through widget.			
Rsvd1	15:12	R	0h	N/A (Hard-coded)
	Reserved.			
SwapCap	11	R	0h	N/A (Hard-coded)
	Left/right swap support: 1 = yes, 0 = no.			
PwrCntrl	10	R	1h	N/A (Hard-coded)
	Power state support: 1 = yes, 0 = no.			
Dig	9	R	1h	N/A (Hard-coded)
	Digital stream support: 1 = yes (digital), 0 = no (analog).			
ConnList	8	R	0h	N/A (Hard-coded)
	Connection list present: 1 = yes, 0 = no.			
UnSolCap	7	R	0h	N/A (Hard-coded)
	Unsolicited response support: 1 = yes, 0 = no.			

Field Name	Bits	R/W	Default	Reset
ProcWidget	6	R	0h	N/A (Hard-coded)
	Processing state support: 1 = yes, 0 = no.			
Stripe	5	R	0h	N/A (Hard-coded)
	Striping support: 1 = yes, 0 = no.			
FormatOvr	4	R	1h	N/A (Hard-coded)
	Stream format override: 1 = yes, 0 = no.			
AmpParOvr	3	R	1h	N/A (Hard-coded)
	Amplifier capabilities override: 1 = yes, no.			
OutAmpPrsnt	2	R	1h	N/A (Hard-coded)
	Output amp present: 1 = yes, 0 = no.			
InAmpPrsnt	1	R	0h	N/A (Hard-coded)
	Input amp present: 1 = yes, 0 = no.			
Stereo	0	R	1h	N/A (Hard-coded)
	Stereo stream support: 1 = yes (stereo), 0 = no (mono).			

### 7.25.1. SPDIFOut0 (NID = 1Dh): PCMCap

Reg	Byte 4 (Bits 31:24)	Byte 3 (Bits 23:16)	Byte 2 (Bits 15:8)	Byte 1 (Bits 7:0)
Set				
Get	F000Ah			

Field Name	Bits	R/W	Default	Reset
Rsvd2	31:21	R	000h	N/A (Hard-coded)
	Reserved.			
B32	20	R	0h	N/A (Hard-coded)
	32 bit audio format support: 1 = yes, 0 = no.			
B24	19	R	1h	N/A (Hard-coded)
	24 bit audio format support: 1 = yes, 0 = no.			



**92HD81****SINGLE CHIP PC AUDIO SYSTEM, CODEC+SPEAKER AMPLIFIER+CAPLESS HP+LDO**

Field Name	Bits	R/W	Default	Reset
B20	18	R	1h	N/A (Hard-coded)
	20 bit audio format support: 1 = yes, 0 = no.			
B16	17	R	1h	N/A (Hard-coded)
	16 bit audio format support: 1 = yes, 0 = no.			
B8	16	R	0h	N/A (Hard-coded)
	8 bit audio format support: 1 = yes, 0 = no.			
Rsvd1	15:12	R	0h	N/A (Hard-coded)
	Reserved.			
R12	11	R	0h	N/A (Hard-coded)
	384kHz rate support: 1 = yes, 0 = no.			
R11	10	R	1h	N/A (Hard-coded)
	192kHz rate support: 1 = yes, 0 = no.			
R10	9	R	0h	N/A (Hard-coded)
	176.4kHz rate support: 1 = yes, 0 = no.			
R9	8	R	1h	N/A (Hard-coded)
	96kHz rate support: 1 = yes, 0 = no.			
R8	7	R	1h	N/A (Hard-coded)
	88.2kHz rate support: 1 = yes, 0 = no.			
R7	6	R	1h	N/A (Hard-coded)
	48kHz rate support: 1 = yes, 0 = no.			
R6	5	R	1h	N/A (Hard-coded)
	44.1kHz rate support: 1 = yes, 0 = no.			
R5	4	R	0h	N/A (Hard-coded)
	32kHz rate support: 1 = yes, 0 = no.			
R4	3	R	0h	N/A (Hard-coded)
	22.05kHz rate support: 1 = yes, 0 = no.			
R3	2	R	0h	N/A (Hard-coded)
	16kHz rate support: 1 = yes, 0 = no.			

Field Name	Bits	R/W	Default	Reset
R2	1	R	0h	N/A (Hard-coded)
	11.025kHz rate support: 1 = yes, 0 = no.			
R1	0	R	0h	N/A (Hard-coded)
	8kHz rate support: 1 = yes, 0 = no.			

### 7.25.2. SPDIFOut0 (NID = 1Dh): StreamCap

Reg	Byte 4 (Bits 31:24)	Byte 3 (Bits 23:16)	Byte 2 (Bits 15:8)	Byte 1 (Bits 7:0)
Set				
Get	F000Bh			

Field Name	Bits	R/W	Default	Reset
Rsvd	31:3	R	00000000h	N/A (Hard-coded)
	Reserved.			
AC3	2	R	1h	N/A (Hard-coded)
	AC-3 formatted data support: 1 = yes, 0 = no.			
Float32	1	R	0h	N/A (Hard-coded)
	Float32 formatted data support: 1 = yes, 0 = no.			
PCM	0	R	1h	N/A (Hard-coded)
	PCM-formatted data support: 1 = yes, 0 = no.			

### 7.25.3. SPDIFOut0 (NID = 1Dh): OutAmpCap

Reg	Byte 4 (Bits 31:24)	Byte 3 (Bits 23:16)	Byte 2 (Bits 15:8)	Byte 1 (Bits 7:0)
Set				
Get	F0012h			

Field Name	Bits	R/W	Default	Reset
Mute	31	R	1h	N/A (Hard-coded)
	Mute support: 1 = yes, 0 = no.			

# 92HD81

## SINGLE CHIP PC AUDIO SYSTEM, CODEC+SPEAKER AMPLIFIER+CAPLESS HP+LDO

Field Name	Bits	R/W	Default	Reset
Rsvd3	30:23	R	00h	N/A (Hard-coded)
	Reserved.			
StepSize	22:16	R	00h	N/A (Hard-coded)
	Size of each step in the gain range: 0 to 127 = .25dB to 32dB, in .25dB steps.			
Rsvd2	15	R	0h	N/A (Hard-coded)
	Reserved.			
NumSteps	14:8	R	00h	N/A (Hard-coded)
	Number of gains steps (number of possible settings - 1).			
Rsvd1	7	R	0h	N/A (Hard-coded)
	Reserved.			
Offset	6:0	R	00h	N/A (Hard-coded)
	Indicates which step is 0dB			

### 7.25.4. SPDIFOut0 (NID = 1Dh): Cnvtr

Reg	Byte 4 (Bits 31:24)	Byte 3 (Bits 23:16)	Byte 2 (Bits 15:8)	Byte 1 (Bits 7:0)
Set				2h
Get	A0000h			

Field Name	Bits	R/W	Default	Reset
Rsvd2	31:16	R	0000h	N/A (Hard-coded)
	Reserved.			
FrmtNonPCM	15	RW	0h	POR - DAFG - ULR
	Stream type: 1 = Non-PCM, 0 = PCM.			
FrmtSmplRate	14	RW	0h	POR - DAFG - ULR
	Sample base rate: 1 = 44.1kHz, 0 = 48kHz.			

# 92HD81

## SINGLE CHIP PC AUDIO SYSTEM, CODEC+SPEAKER AMPLIFIER+CAPLESS HP+LDO

Field Name	Bits	R/W	Default	Reset
SmplRateMultp	13:11	RW	0h	POR - DAFG - ULR
	Sample base rate multiple: 000b= x1 (48kHz/44.1kHz or less) 001b= x2 (96kHz/88.2kHz/32kHz) 010b= x3 (144kHz) 011b= x4 (192kHz/176.4kHz) 100b-111b Reserved			
SmplRateDiv	10:8	RW	0h	POR - DAFG - ULR
	Sample base rate divider: 000b= Divide by 1 (48kHz/44.1kHz) 001b= Divide by 2 (24kHz/20.05kHz) 010b= Divide by 3 (16kHz/32kHz) 011b= Divide by 4 (11.025kHz) 100b= Divide by 5 (9.6kHz) 101b= Divide by 6 (8kHz) 110b= Divide by 7 111b= Divide by 8 (6kHz)			
Rsvd1	7	R	0h	N/A (Hard-coded)
	Reserved.			
BitsPerSmpl	6:4	RW	3h	POR - DAFG - ULR
	Bits per sample: 000b= 8 bits 001b= 16 bits 010b= 20 bits 011b= 24 bits 100b= 32 bits 101b-111b= Reserved			
NmbrChan	3:0	RW	1h	POR - DAFG - ULR
	Total number of channels in the stream assigned to this converter: 0000b-1111b= 1-16 channels.			

### 7.25.5. SPDIFOut0 (NID = 1Dh): OutAmpLeft

Reg	Byte 4 (Bits 31:24)	Byte 3 (Bits 23:16)	Byte 2 (Bits 15:8)	Byte 1 (Bits 7:0)
Set				3A0h
Get	BA000h			

Field Name	Bits	R/W	Default	Reset
Rsvd2	31:8	R	000000h	N/A (Hard-coded)
	Reserved.			
Mute	7	RW	0h	POR - DAFG - ULR
	Amp mute: 1 = muted, 0 = not muted.			
Rsvd1	6:0	R	00h	N/A (Hard-coded)
	Reserved.			

#### 7.25.6. SPDIFOut0 (NID = 1Dh): OutAmpRight

Reg	Byte 4 (Bits 31:24)	Byte 3 (Bits 23:16)	Byte 2 (Bits 15:8)	Byte 1 (Bits 7:0)
Set				390h
Get	B8000h			

Field Name	Bits	R/W	Default	Reset
Rsvd2	31:8	R	000000h	N/A (Hard-coded)
	Reserved.			
Mute	7	RW	0h	POR - DAFG - ULR
	Amp mute: 1 = muted, 0 = not muted.			
Rsvd1	6:0	R	00h	N/A (Hard-coded)
	Reserved.			

#### 7.25.7. SPDIFOut0 (NID = 1Dh): PwrState

Reg	Byte 4 (Bits 31:24)	Byte 3 (Bits 23:16)	Byte 2 (Bits 15:8)	Byte 1 (Bits 7:0)
Set				705h
Get	F0500h			

Field Name	Bits	R/W	Default	Reset
Rsvd4	31:11	R	000000h	N/A (Hard-coded)
	Reserved.			

# 92HD81

## SINGLE CHIP PC AUDIO SYSTEM, CODEC+SPEAKER AMPLIFIER+CAPLESS HP+LDO

Field Name	Bits	R/W	Default	Reset
SettingsReset	10	R	1h	POR - DAFG - ULR
	Indicates if any persistent settings in this Widget have been reset. Cleared by PwrState 'Get', or a 'Set' to any Verb in this Widget.			
Rsvd3	9	R	0h	N/A (Hard-coded)
	Reserved.			
Error	8	R	0h	POR - DAFG - ULR
	Error indicator: 1 = cannot enter requested power state, 0 = no problem with requested power state.			
Rsvd2	7:6	R	0h	N/A (Hard-coded)
	Reserved.			
Act	5:4	R	3h	POR - DAFG - LR
	Actual power state of this widget.			
Rsvd1	3:2	R	0h	N/A (Hard-coded)
	Reserved.			
Set	1:0	RW	3h	POR - DAFG - LR
	Current power state setting for this widget.			

### 7.25.8. SPDIFOut0 (NID = 1Dh): CnvtrID

Reg	Byte 4 (Bits 31:24)	Byte 3 (Bits 23:16)	Byte 2 (Bits 15:8)	Byte 1 (Bits 7:0)
Set				706h
Get	F0600h			

Field Name	Bits	R/W	Default	Reset
Rsvd	31:8	R	000000h	N/A (Hard-coded)
	Reserved.			
Strm	7:4	RW	0h	POR - S&DAFG - LR - PS
	Stream ID: 0h = Converter "off", 1h-Fh = valid ID's.			
Ch	3:0	RW	0h	POR - S&DAFG - LR - PS
	Channel assignment ("Ch" and "Ch+1" assigned as a pair, for a stereo converter).			

## 7.25.9. SPDIFOut0 (NID = 1Dh): DigCnvtr

Reg	Byte 4 (Bits 31:24)	Byte 3 (Bits 23:16)	Byte 2 (Bits 15:8)	Byte 1 (Bits 7:0)
Set	73Fh	73Eh	70Eh	70Dh
Get	F0E00h / F0D00h			

Field Name	Bits	R/W	Default	Reset
Rsvd2	31:24	R	00h	N/A (Hard-coded)
	Reserved.			
KeepAlive	23	RW	0h	POR - DAFG - ULR
	Keep Alive Enable: 1 = clocking information maintained during D3, 0 = clock information not required during D3.			
Rsvd1	22:15	R	00h	N/A (Hard-coded)
	Reserved.			
CC	14:8	RW	00h	POR - DAFG - ULR
	CC: Category Code.			
L	7	RW	0h	POR - DAFG - ULR
	L: Generation Level.			
PRO	6	RW	0h	POR - DAFG - ULR
	PRO: Professional.			
AUDIO	5	RW	0h	POR - DAFG - ULR
	/AUDIO: Non-Audio.			
COPY	4	RW	0h	POR - DAFG - ULR
	COPY: Copyright.			
PRE	3	RW	0h	POR - DAFG - ULR
	PRE: Preemphasis.			
VCFG	2	RW	0h	POR - DAFG - ULR
	VCFG: Validity Config.			
V	1	RW	0h	POR - DAFG - ULR
	V: Validity.			

Field Name	Bits	R/W	Default	Reset
DigEn	0	RW	0h	POR - DAFG - ULR
Digital enable: 1 = converter enabled, 0 = converter disable.				

### 7.26. SPDIFOut1 (NID = 1Eh): WCap

Reg	Byte 4 (Bits 31:24)	Byte 3 (Bits 23:16)	Byte 2 (Bits 15:8)	Byte 1 (Bits 7:0)
Set				
Get	F0009h			

Field Name	Bits	R/W	Default	Reset
Rsvd2	31:24	R	00h	N/A (Hard-coded)
Reserved.				
Type	23:20	R	0h	N/A (Hard-coded)
Widget type: 0h = Out Converter 1h = In Converter 2h = Summing (Mixer) 3h = Selector (Mux) 4h = Pin Complex 5h = Power 6h = Volume Knob 7h = Beep Generator 8h-Eh = Reserved Fh = Vendor Defined				
Delay	19:16	R	4h	N/A (Hard-coded)
Number of sample delays through widget.				
Rsvd1	15:12	R	0h	N/A (Hard-coded)
Reserved.				
SwapCap	11	R	0h	N/A (Hard-coded)
Left/right swap support: 1 = yes, 0 = no.				
PwrCntrl	10	R	1h	N/A (Hard-coded)
Power state support: 1 = yes, 0 = no.				
Dig	9	R	1h	N/A (Hard-coded)
Digital stream support: 1 = yes (digital), 0 = no (analog).				



# 92HD81

## SINGLE CHIP PC AUDIO SYSTEM, CODEC+SPEAKER AMPLIFIER+CAPLESS HP+LDO

Field Name	Bits	R/W	Default	Reset
ConnList	8	R	0h	N/A (Hard-coded)
	Connection list present: 1 = yes, 0 = no.			
UnSolCap	7	R	0h	N/A (Hard-coded)
	Unsolicited response support: 1 = yes, 0 = no.			
ProcWidget	6	R	0h	N/A (Hard-coded)
	Processing state support: 1 = yes, 0 = no.			
Stripe	5	R	0h	N/A (Hard-coded)
	Striping support: 1 = yes, 0 = no.			
FormatOvr	4	R	1h	N/A (Hard-coded)
	Stream format override: 1 = yes, 0 = no.			
AmpParOvr	3	R	1h	N/A (Hard-coded)
	Amplifier capabilities override: 1 = yes, no.			
OutAmpPrsnt	2	R	1h	N/A (Hard-coded)
	Output amp present: 1 = yes, 0 = no.			
InAmpPrsnt	1	R	0h	N/A (Hard-coded)
	Input amp present: 1 = yes, 0 = no.			
Stereo	0	R	1h	N/A (Hard-coded)
	Stereo stream support: 1 = yes (stereo), 0 = no (mono).			

### 7.26.1. SPDIFOut1 (NID = 1Eh): PCMCap

Reg	Byte 4 (Bits 31:24)	Byte 3 (Bits 23:16)	Byte 2 (Bits 15:8)	Byte 1 (Bits 7:0)
Set				
Get	F000Ah			

Field Name	Bits	R/W	Default	Reset
Rsvd2	31:21	R	000h	N/A (Hard-coded)
	Reserved.			

**92HD81****SINGLE CHIP PC AUDIO SYSTEM, CODEC+SPEAKER AMPLIFIER+CAPLESS HP+LDO**

Field Name	Bits	R/W	Default	Reset
B32	20	R	0h	N/A (Hard-coded)
	32 bit audio format support: 1 = yes, 0 = no.			
B24	19	R	1h	N/A (Hard-coded)
	24 bit audio format support: 1 = yes, 0 = no.			
B20	18	R	1h	N/A (Hard-coded)
	20 bit audio format support: 1 = yes, 0 = no.			
B16	17	R	1h	N/A (Hard-coded)
	16 bit audio format support: 1 = yes, 0 = no.			
B8	16	R	0h	N/A (Hard-coded)
	8 bit audio format support: 1 = yes, 0 = no.			
Rsvd1	15:12	R	0h	N/A (Hard-coded)
	Reserved.			
R12	11	R	0h	N/A (Hard-coded)
	384kHz rate support: 1 = yes, 0 = no.			
R11	10	R	1h	N/A (Hard-coded)
	192kHz rate support: 1 = yes, 0 = no.			
R10	9	R	0h	N/A (Hard-coded)
	176.4kHz rate support: 1 = yes, 0 = no.			
R9	8	R	1h	N/A (Hard-coded)
	96kHz rate support: 1 = yes, 0 = no.			
R8	7	R	1h	N/A (Hard-coded)
	88.2kHz rate support: 1 = yes, 0 = no.			
R7	6	R	1h	N/A (Hard-coded)
	48kHz rate support: 1 = yes, 0 = no.			
R6	5	R	1h	N/A (Hard-coded)
	44.1kHz rate support: 1 = yes, 0 = no.			
R5	4	R	0h	N/A (Hard-coded)
	32kHz rate support: 1 = yes, 0 = no.			

Field Name	Bits	R/W	Default	Reset
R4	3	R	0h	N/A (Hard-coded)
	22.05kHz rate support: 1 = yes, 0 = no.			
R3	2	R	0h	N/A (Hard-coded)
	16kHz rate support: 1 = yes, 0 = no.			
R2	1	R	0h	N/A (Hard-coded)
	11.025kHz rate support: 1 = yes, 0 = no.			
R1	0	R	0h	N/A (Hard-coded)
	8kHz rate support: 1 = yes, 0 = no.			

### 7.26.2. SPDIFOut1 (NID = 1Eh): StreamCap

Reg	Byte 4 (Bits 31:24)	Byte 3 (Bits 23:16)	Byte 2 (Bits 15:8)	Byte 1 (Bits 7:0)
Set				
Get	F000Bh			

Field Name	Bits	R/W	Default	Reset
Rsvd	31:3	R	00000000h	N/A (Hard-coded)
	Reserved.			
AC3	2	R	1h	N/A (Hard-coded)
	AC-3 formatted data support: 1 = yes, 0 = no.			
Float32	1	R	0h	N/A (Hard-coded)
	Float32 formatted data support: 1 = yes, 0 = no.			
PCM	0	R	1h	N/A (Hard-coded)
	PCM-formatted data support: 1 = yes, 0 = no.			

### 7.26.3. SPDIFOut1 (NID = 1Eh): OutAmpCap

Reg	Byte 4 (Bits 31:24)	Byte 3 (Bits 23:16)	Byte 2 (Bits 15:8)	Byte 1 (Bits 7:0)
Set				
Get	F0012h			

# 92HD81

## SINGLE CHIP PC AUDIO SYSTEM, CODEC+SPEAKER AMPLIFIER+CAPLESS HP+LDO

Field Name	Bits	R/W	Default	Reset
Mute	31	R	1h	N/A (Hard-coded)
	Mute support: 1 = yes, 0 = no.			
Rsvd3	30:23	R	00h	N/A (Hard-coded)
	Reserved.			
StepSize	22:16	R	00h	N/A (Hard-coded)
	Size of each step in the gain range: 0 to 127 = .25dB to 32dB, in .25dB steps.			
Rsvd2	15	R	0h	N/A (Hard-coded)
	Reserved.			
NumSteps	14:8	R	00h	N/A (Hard-coded)
	Number of gains steps (number of possible settings - 1).			
Rsvd1	7	R	0h	N/A (Hard-coded)
	Reserved.			
Offset	6:0	R	00h	N/A (Hard-coded)
	Indicates which step is 0dB			

### 7.26.4. SPDIFOut1 (NID = 1Eh): Cnvtr

Reg	Byte 4 (Bits 31:24)	Byte 3 (Bits 23:16)	Byte 2 (Bits 15:8)	Byte 1 (Bits 7:0)
Set				2h
Get	A0000h			

Field Name	Bits	R/W	Default	Reset
Rsvd2	31:16	R	0000h	N/A (Hard-coded)
	Reserved.			
FrmtNonPCM	15	RW	0h	POR - DAFG - ULR
	Stream type: 1 = Non-PCM, 0 = PCM.			
FrmtSmpIRate	14	RW	0h	POR - DAFG - ULR
	Sample base rate: 1 = 44.1kHz, 0 = 48kHz.			

# 92HD81

## SINGLE CHIP PC AUDIO SYSTEM, CODEC+SPEAKER AMPLIFIER+CAPLESS HP+LDO

Field Name	Bits	R/W	Default	Reset
SmplRateMultp	13:11	RW	0h	POR - DAFG - ULR
	Sample base rate multiple: 000b= x1 (48kHz/44.1kHz or less) 001b= x2 (96kHz/88.2kHz/32kHz) 010b= x3 (144kHz) 011b= x4 (192kHz/176.4kHz) 100b-111b Reserved			
SmplRateDiv	10:8	RW	0h	POR - DAFG - ULR
	Sample base rate divider: 000b= Divide by 1 (48kHz/44.1kHz) 001b= Divide by 2 (24kHz/20.05kHz) 010b= Divide by 3 (16kHz/32kHz) 011b= Divide by 4 (11.025kHz) 100b= Divide by 5 (9.6kHz) 101b= Divide by 6 (8kHz) 110b= Divide by 7 111b= Divide by 8 (6kHz)			
Rsvd1	7	R	0h	N/A (Hard-coded)
	Reserved.			
BitsPerSmpl	6:4	RW	3h	POR - DAFG - ULR
	Bits per sample: 000b= 8 bits 001b= 16 bits 010b= 20 bits 011b= 24 bits 100b= 32 bits 101b-111b= Reserved			
NmbrChan	3:0	RW	1h	POR - DAFG - ULR
	Total number of channels in the stream assigned to this converter: 0000b-1111b= 1-16 channels.			

### 7.26.5. SPDIFOut1 (NID = 1Eh): OutAmpLeft

Reg	Byte 4 (Bits 31:24)	Byte 3 (Bits 23:16)	Byte 2 (Bits 15:8)	Byte 1 (Bits 7:0)
Set				3A0h
Get	BA00h			

Field Name	Bits	R/W	Default	Reset
Rsvd2	31:8	R	000000h	N/A (Hard-coded)
	Reserved.			
Mute	7	RW	0h	POR - DAFG - ULR
	Amp mute: 1 = muted, 0 = not muted.			
Rsvd1	6:0	R	00h	N/A (Hard-coded)
	Reserved.			

#### 7.26.6. SPDIFOut1 (NID = 1Eh): OutAmpRight

Reg	Byte 4 (Bits 31:24)	Byte 3 (Bits 23:16)	Byte 2 (Bits 15:8)	Byte 1 (Bits 7:0)
Set				390h
Get	B8000h			

Field Name	Bits	R/W	Default	Reset
Rsvd2	31:8	R	000000h	N/A (Hard-coded)
	Reserved.			
Mute	7	RW	0h	POR - DAFG - ULR
	Amp mute: 1 = muted, 0 = not muted.			
Rsvd1	6:0	R	00h	N/A (Hard-coded)
	Reserved.			

#### 7.26.7. SPDIFOut1 (NID = 1Eh): PwrState

Reg	Byte 4 (Bits 31:24)	Byte 3 (Bits 23:16)	Byte 2 (Bits 15:8)	Byte 1 (Bits 7:0)
Set				705h
Get	F0500h			

Field Name	Bits	R/W	Default	Reset
Rsvd4	31:11	R	000000h	N/A (Hard-coded)
	Reserved.			

Field Name	Bits	R/W	Default	Reset
SettingsReset	10	R	1h	POR - DAFG - ULR
	Indicates if any persistent settings in this Widget have been reset. Cleared by PwrState 'Get', or a 'Set' to any Verb in this Widget.			
Rsvd3	9	R	0h	N/A (Hard-coded)
	Reserved.			
Error	8	R	0h	POR - DAFG - ULR
	Error indicator: 1 = cannot enter requested power state, 0 = no problem with requested power state.			
Rsvd2	7:6	R	0h	N/A (Hard-coded)
	Reserved.			
Act	5:4	R	3h	POR - DAFG - LR
	Actual power state of this widget.			
Rsvd1	3:2	R	0h	N/A (Hard-coded)
	Reserved.			
Set	1:0	RW	3h	POR - DAFG - LR
	Current power state setting for this widget.			

#### 7.26.8. SPDIFOut1 (NID = 1Eh): CnvtrID

Reg	Byte 4 (Bits 31:24)	Byte 3 (Bits 23:16)	Byte 2 (Bits 15:8)	Byte 1 (Bits 7:0)
Set				706h
Get	F0600h			

Field Name	Bits	R/W	Default	Reset
Rsvd	31:8	R	000000h	N/A (Hard-coded)
	Reserved.			
Strm	7:4	RW	0h	POR - S&DAFG - LR - PS
	Stream ID: 0h = Converter "off", 1h-Fh = valid ID's.			
Ch	3:0	RW	0h	POR - S&DAFG - LR - PS
	Channel assignment ("Ch" and "Ch+1" assigned as a pair, for a stereo converter).			

## 7.26.9. SPDIFOut1 (NID = 1Eh): DigCnvtr

Reg	Byte 4 (Bits 31:24)	Byte 3 (Bits 23:16)	Byte 2 (Bits 15:8)	Byte 1 (Bits 7:0)
Set	73Fh	73Eh	70Eh	70Dh
Get	F0E00h / F0D00h			

Field Name	Bits	R/W	Default	Reset
Rsvd2	31:24	R	00h	N/A (Hard-coded)
	Reserved.			
KeepAlive	23	RW	0h	POR - DAFG - ULR
	Keep Alive Enable: 1 = clocking information maintained during D3, 0 = clock information not required during D3.			
Rsvd1	22:15	R	00h	N/A (Hard-coded)
	Reserved.			
CC	14:8	RW	00h	POR - DAFG - ULR
	CC: Category Code.			
L	7	RW	0h	POR - DAFG - ULR
	L: Generation Level.			
PRO	6	RW	0h	POR - DAFG - ULR
	PRO: Professional.			
AUDIO	5	RW	0h	POR - DAFG - ULR
	/AUDIO: Non-Audio.			
COPY	4	RW	0h	POR - DAFG - ULR
	COPY: Copyright.			
PRE	3	RW	0h	POR - DAFG - ULR
	PRE: Preemphasis.			
VCFG	2	RW	0h	POR - DAFG - ULR
	VCFG: Validity Config.			
V	1	RW	0h	POR - DAFG - ULR
	V: Validity.			



Field Name	Bits	R/W	Default	Reset
DigEn	0	RW	0h	POR - DAFG - ULR
Digital enable: 1 = converter enabled, 0 = converter disable.				

### 7.27. Dig0Pin (NID = 1Fh): WCap

Reg	Byte 4 (Bits 31:24)	Byte 3 (Bits 23:16)	Byte 2 (Bits 15:8)	Byte 1 (Bits 7:0)
Set				
Get	F0009h			

Field Name	Bits	R/W	Default	Reset
Rsvd2	31:24	R	00h	N/A (Hard-coded)
Reserved.				
Type	23:20	R	4h	N/A (Hard-coded)
Widget type: 0h = Out Converter 1h = In Converter 2h = Summing (Mixer) 3h = Selector (Mux) 4h = Pin Complex 5h = Power 6h = Volume Knob 7h = Beep Generator 8h-Eh = Reserved Fh = Vendor Defined				
Delay	19:16	R	0h	N/A (Hard-coded)
Number of sample delays through widget.				
Rsvd1	15:12	R	0h	N/A (Hard-coded)
Reserved.				
SwapCap	11	R	0h	N/A (Hard-coded)
Left/right swap support: 1 = yes, 0 = no.				
PwrCntrl	10	R	1h	N/A (Hard-coded)
Power state support: 1 = yes, 0 = no.				
Dig	9	R	1h	N/A (Hard-coded)
Digital stream support: 1 = yes (digital), 0 = no (analog).				

# 92HD81

## SINGLE CHIP PC AUDIO SYSTEM, CODEC+SPEAKER AMPLIFIER+CAPLESS HP+LDO

Field Name	Bits	R/W	Default	Reset
ConnList	8	R	1h	N/A (Hard-coded)
	Connection list present: 1 = yes, 0 = no.			
UnSolCap	7	R	1h	N/A (Hard-coded)
	Unsolicited response support: 1 = yes, 0 = no.			
ProcWidget	6	R	0h	N/A (Hard-coded)
	Processing state support: 1 = yes, 0 = no.			
Stripe	5	R	0h	N/A (Hard-coded)
	Striping support: 1 = yes, 0 = no.			
FormatOvr	4	R	0h	N/A (Hard-coded)
	Stream format override: 1 = yes, 0 = no.			
AmpParOvr	3	R	0h	N/A (Hard-coded)
	Amplifier capabilities override: 1 = yes, no.			
OutAmpPrsnt	2	R	0h	N/A (Hard-coded)
	Output amp present: 1 = yes, 0 = no.			
InAmpPrsnt	1	R	0h	N/A (Hard-coded)
	Input amp present: 1 = yes, 0 = no.			
Stereo	0	R	1h	N/A (Hard-coded)
	Stereo stream support: 1 = yes (stereo), 0 = no (mono).			

### 7.27.1. Dig0Pin (NID = 1Fh): PinCap

Reg	Byte 4 (Bits 31:24)	Byte 3 (Bits 23:16)	Byte 2 (Bits 15:8)	Byte 1 (Bits 7:0)
Set				
Get	F000Ch			

Field Name	Bits	R/W	Default	Reset
Rsvd2	31:17	R	0000h	N/A (Hard-coded)
	Reserved.			

Field Name	Bits	R/W	Default	Reset
EapdCap	16	R	0h	N/A (Hard-coded)
	EAPD support: 1 = yes, 0 = no.			
VrefCntrl	15:8	R	00h	N/A (Hard-coded)
	Vref support: bit 7 = Reserved bit 6 = Reserved bit 5 = 100% support (1 = yes, 0 = no) bit 4 = 80% support (1 = yes, 0 = no) bit 3 = Reserved bit 2 = GND support (1 = yes, 0 = no) bit 1 = 50% support (1 = yes, 0 = no) bit 0 = Hi-Z support (1 = yes, 0 = no)			
Rsvd1	7	R	0h	N/A (Hard-coded)
	Reserved.			
BalancedIO	6	R	0h	N/A (Hard-coded)
	Balanced I/O support: 1 = yes, 0 = no.			
InCap	5	R	0h	N/A (Hard-coded)
	Input support: 1 = yes, 0 = no.			
OutCap	4	R	1h	N/A (Hard-coded)
	Output support: 1 = yes, 0 = no.			
HdphDrvCap	3	R	0h	N/A (Hard-coded)
	Headphone amp present: 1 = yes, 0 = no.			
PresDtctCap	2	R	1h	N/A (Hard-coded)
	Presence detection support: 1 = yes, 0 = no.			
TrigRqd	1	R	0h	N/A (Hard-coded)
	Trigger required for impedance sense: 1 = yes, 0 = no.			
ImpSenseCap	0	R	0h	N/A (Hard-coded)
	Impedance sense support: 1 = yes, 0 = no.			

### 7.27.2. Dig0Pin (NID = 1Fh): ConLst

Reg	Byte 4 (Bits 31:24)	Byte 3 (Bits 23:16)	Byte 2 (Bits 15:8)	Byte 1 (Bits 7:0)
Set				
Get	F000Eh			

Field Name	Bits	R/W	Default	Reset
Rsvd	31:8	R	000000h	N/A (Hard-coded)
	Reserved.			
LForm	7	R	0h	N/A (Hard-coded)
	Connection list format: 1 = long-form (15-bit) NID entries, 0 = short-form (7-bit) NID entries.			
ConL	6:0	R	01h	N/A (Hard-coded)
	Number of NID entries in connection list.			

### 7.27.3. Dig0Pin (NID = 1Fh): ConLstEntry0

Reg	Byte 4 (Bits 31:24)	Byte 3 (Bits 23:16)	Byte 2 (Bits 15:8)	Byte 1 (Bits 7:0)
Set				
Get	F0200h			

Field Name	Bits	R/W	Default	Reset
ConL3	31:24	R	00h	N/A (Hard-coded)
	Unused list entry.			
ConL2	23:16	R	00h	N/A (Hard-coded)
	Unused list entry.			
ConL1	15:8	R	00h	N/A (Hard-coded)
	Unused list entry.			
ConL0	7:0	R	1Dh	N/A (Hard-coded)
	SPDIFOut0 Converter widget (0x1D)			

### 7.27.4. Dig0Pin (NID = 1Fh): PwrState

Reg	Byte 4 (Bits 31:24)	Byte 3 (Bits 23:16)	Byte 2 (Bits 15:8)	Byte 1 (Bits 7:0)
Set				705h
Get	F0500h			

Field Name	Bits	R/W	Default	Reset
Rsvd4	31:11	R	000000h	N/A (Hard-coded)
	Reserved.			
SettingsReset	10	R	1h	POR - DAFG - ULR
	Indicates if any persistent settings in this Widget have been reset. Cleared by PwrState 'Get', or a 'Set' to any Verb in this Widget.			
Rsvd3	9	R	0h	N/A (Hard-coded)
	Reserved.			
Error	8	R	0h	POR - DAFG - ULR
	Error indicator: 1 = cannot enter requested power state, 0 = no problem with requested power state.			
Rsvd2	7:6	R	0h	N/A (Hard-coded)
	Reserved.			
Act	5:4	R	3h	POR - DAFG - LR
	Actual power state of this widget.			
Rsvd1	3:2	R	0h	N/A (Hard-coded)
	Reserved.			
Set	1:0	RW	0h	POR - DAFG - LR
	Current power state setting for this widget.			

#### 7.27.5. Dig0Pin (NID = 1Fh): PinWCntrl

Reg	Byte 4 (Bits 31:24)	Byte 3 (Bits 23:16)	Byte 2 (Bits 15:8)	Byte 1 (Bits 7:0)
Set				707h
Get	F0700h			

Field Name	Bits	R/W	Default	Reset
Rsvd2	31:7	R	0000000h	N/A (Hard-coded)
	Reserved.			
OutEn	6	RW	0h	POR - DAFG - ULR
	Output enable: 1 = enabled, 0 = disabled.			

Field Name	Bits	R/W	Default	Reset
Rsvd1	5:0	R	00h	N/A (Hard-coded)
	Reserved.			

### 7.27.6. Dig0Pin (NID = 1Fh): UnsolResp

Reg	Byte 4 (Bits 31:24)	Byte 3 (Bits 23:16)	Byte 2 (Bits 15:8)	Byte 1 (Bits 7:0)
Set				708h
Get	F0800h			

Field Name	Bits	R/W	Default	Reset
Rsvd2	31:8	R	000000h	N/A (Hard-coded)
	Reserved.			
En	7	RW	0h	POR - DAFG - ULR
	Unsolicited response enable (also enables Wake events for this Widget): 1 = enabled, 0 = disabled.			
Rsvd1	6	R	0h	N/A (Hard-coded)
	Reserved.			
Tag	5:0	RW	00h	POR - DAFG - ULR
	Software programmable field returned in top six bits (31:26) of every Unsolicited Response generated by this node.			

### 7.27.7. Dig0Pin (NID = 1Fh): ChSense

Reg	Byte 4 (Bits 31:24)	Byte 3 (Bits 23:16)	Byte 2 (Bits 15:8)	Byte 1 (Bits 7:0)
Set				709h
Get	F0900h			

Field Name	Bits	R/W	Default	Reset
PresDtct	31	R	0h	POR
	Presence detection indicator: 1 = presence detected; 0 = presence not detected.			

Field Name	Bits	R/W	Default	Reset
Rsvd	30:0	R	00000000h	N/A (Hard-coded)
Reserved.				

**7.27.8. Dig0Pin (NID = 1Fh): ConfigDefault**

Reg	Byte 4 (Bits 31:24)	Byte 3 (Bits 23:16)	Byte 2 (Bits 15:8)	Byte 1 (Bits 7:0)
Set	71Fh	71Eh	71Dh	71Ch
Get	F1F00h / F1E00h / F1D00h / F1C00h			

Field Name	Bits	R/W	Default	Reset
PortConnectivity	31:30	RW	0h	POR
Port connectivity: 0h = Port complex is connected to a jack 1h = No physical connection for port 2h = Fixed function device is attached 3h = Both jack and internal device attached (info in all other fields refers to integrated device, any presence detection refers to jack)				
Location	29:24	RW	1h	POR
Location  Bits [5..4]: 0h = External on primary chassis 1h = Internal 2h = Separate chassis 3h = Other  Bits [3..0]: 0h = N/A 1h = Rear 2h = Front 3h = Left 4h = Right 5h = Top 6h = Bottom 7h-9h = Special Ah-Fh = Reserved				

# 92HD81

## SINGLE CHIP PC AUDIO SYSTEM, CODEC+SPEAKER AMPLIFIER+CAPLESS HP+LDO

Field Name	Bits	R/W	Default	Reset
Device	23:20	RW	4h	POR
	Default device: 0h = Line out 1h = Speaker 2h = HP out 3h = CD 4h = SPDIF Out 5h = Digital other out 6h = Modem line side 7h = Modem handset side 8h = Line in 9h = Aux Ah = Mic in Bh = Telephony Ch = SPDIF In Dh = Digital other in Eh = Reserved Fh = Other			
ConnectionType	19:16	RW	5h	POR
	Connection type: 0h = Unknown 1h = 1/8" stereo/mono 2h = 1/4" stereo/mono 3h = ATAPI internal 4h = RCA 5h = Optical 6h = Other digital 7h = Other analog 8h = Multichannel analog (DIN) 9h = XLR/Professional Ah = RJ-11 (modem) Bh = Combination Ch-Eh = Reserved Fh = Other			



Field Name	Bits	R/W	Default	Reset
Color	15:12	RW	1h	POR
	Color: 0h = Unknown 1h = Black 2h = Grey 3h = Blue 4h = Green 5h = Red 6h = Orange 7h = Yellow 8h = Purple 9h = Pink Ah-Dh = Reserved Eh = White Fh = Other			
Misc	11:8	RW	1h	POR
	Miscellaneous: Bits [3..1] = Reserved Bit 0 = Jack detect override			
Association	7:4	RW	6h	POR
	Default association.			
Sequence	3:0	RW	0h	POR
	Sequence.			

**7.28. Dig1Pin (NID = 20h): WCap**

Reg	Byte 4 (Bits 31:24)	Byte 3 (Bits 23:16)	Byte 2 (Bits 15:8)	Byte 1 (Bits 7:0)
Set				
Get	F0009h			

Field Name	Bits	R/W	Default	Reset
Rsvd2	31:24	R	00h	N/A (Hard-coded)
	Reserved.			

# 92HD81

## SINGLE CHIP PC AUDIO SYSTEM, CODEC+SPEAKER AMPLIFIER+CAPLESS HP+LDO

Field Name	Bits	R/W	Default	Reset
Type	23:20	R	4h	N/A (Hard-coded)
Widget type: 0h = Out Converter 1h = In Converter 2h = Summing (Mixer) 3h = Selector (Mux) 4h = Pin Complex 5h = Power 6h = Volume Knob 7h = Beep Generator 8h-Eh = Reserved Fh = Vendor Defined				
Delay	19:16	R	0h	N/A (Hard-coded)
Number of sample delays through widget.				
Rsvd1	15:12	R	0h	N/A (Hard-coded)
Reserved.				
SwapCap	11	R	0h	N/A (Hard-coded)
Left/right swap support: 1 = yes, 0 = no.				
PwrCntrl	10	R	1h	N/A (Hard-coded)
Power state support: 1 = yes, 0 = no.				
Dig	9	R	1h	N/A (Hard-coded)
Digital stream support: 1 = yes (digital), 0 = no (analog).				
ConnList	8	R	1h	N/A (Hard-coded)
Connection list present: 1 = yes, 0 = no.				
UnSolCap	7	R	1h	N/A (Hard-coded)
Unsolicited response support: 1 = yes, 0 = no.				
ProcWidget	6	R	0h	N/A (Hard-coded)
Processing state support: 1 = yes, 0 = no.				
Stripe	5	R	0h	N/A (Hard-coded)
Striping support: 1 = yes, 0 = no.				
FormatOvrd	4	R	0h	N/A (Hard-coded)
Stream format override: 1 = yes, 0 = no.				

Field Name	Bits	R/W	Default	Reset
AmpParOvrd	3	R	0h	N/A (Hard-coded)
Amplifier capabilities override: 1 = yes, no.				
OutAmpPrsnt	2	R	0h	N/A (Hard-coded)
Output amp present: 1 = yes, 0 = no.				
InAmpPrsnt	1	R	0h	N/A (Hard-coded)
Input amp present: 1 = yes, 0 = no.				
Stereo	0	R	1h	N/A (Hard-coded)
Stereo stream support: 1 = yes (stereo), 0 = no (mono).				

### 7.28.1. Dig1Pin (NID = 20h): PinCap

Reg	Byte 4 (Bits 31:24)	Byte 3 (Bits 23:16)	Byte 2 (Bits 15:8)	Byte 1 (Bits 7:0)
Set				
Get	F000Ch			

Field Name	Bits	R/W	Default	Reset
Rsvd2	31:17	R	0000h	N/A (Hard-coded)
Reserved.				
EapdCap	16	R	0h	N/A (Hard-coded)
EAPD support: 1 = yes, 0 = no.				
VrefCntrl	15:8	R	00h	N/A (Hard-coded)
Vref support: bit 7 = Reserved bit 6 = Reserved bit 5 = 100% support (1 = yes, 0 = no) bit 4 = 80% support (1 = yes, 0 = no) bit 3 = Reserved bit 2 = GND support (1 = yes, 0 = no) bit 1 = 50% support (1 = yes, 0 = no) bit 0 = Hi-Z support (1 = yes, 0 = no)				
Rsvd1	7	R	0h	N/A (Hard-coded)
Reserved.				

Field Name	Bits	R/W	Default	Reset
BalancedIO	6	R	0h	N/A (Hard-coded)
	Balanced I/O support: 1 = yes, 0 = no.			
InCap	5	R	1h	N/A (Hard-coded)
	Input support: 1 = yes, 0 = no.			
OutCap	4	R	1h	N/A (Hard-coded)
	Output support: 1 = yes, 0 = no.			
HdphDrvCap	3	R	0h	N/A (Hard-coded)
	Headphone amp present: 1 = yes, 0 = no.			
PresDtctCap	2	R	1h	N/A (Hard-coded)
	Presence detection support: 1 = yes, 0 = no.			
TrigRqd	1	R	0h	N/A (Hard-coded)
	Trigger required for impedance sense: 1 = yes, 0 = no.			
ImpSenseCap	0	R	0h	N/A (Hard-coded)
	Impedance sense support: 1 = yes, 0 = no.			

### 7.28.2. Dig1Pin (NID = 20h): ConLst

Reg	Byte 4 (Bits 31:24)	Byte 3 (Bits 23:16)	Byte 2 (Bits 15:8)	Byte 1 (Bits 7:0)
Set				
Get	F000Eh			

Field Name	Bits	R/W	Default	Reset
Rsvd	31:8	R	000000h	N/A (Hard-coded)
	Reserved.			
LForm	7	R	0h	N/A (Hard-coded)
	Connection list format: 1 = long-form (15-bit) NID entries, 0 = short-form (7-bit) NID entries.			
ConL	6:0	R	01h	N/A (Hard-coded)
	Number of NID entries in connection list.			

7.28.3. *Dig1Pin (NID = 20h): ConLstEntry0*

Reg	Byte 4 (Bits 31:24)	Byte 3 (Bits 23:16)	Byte 2 (Bits 15:8)	Byte 1 (Bits 7:0)
Set				
Get	F0200h			

Field Name	Bits	R/W	Default	Reset
ConL3	31:24	R	00h	N/A (Hard-coded)
	Unused list entry.			
ConL2	23:16	R	00h	N/A (Hard-coded)
	Unused list entry.			
ConL1	15:8	R	00h	N/A (Hard-coded)
	Unused list entry.			
ConL0	7:0	R	1Eh	N/A (Hard-coded)
	SPDIFOut1 Converter widget (0x1E)			

7.28.4. *Dig1Pin (NID = 20h): PwrState*

Reg	Byte 4 (Bits 31:24)	Byte 3 (Bits 23:16)	Byte 2 (Bits 15:8)	Byte 1 (Bits 7:0)
Set				705h
Get	F0500h			

Field Name	Bits	R/W	Default	Reset
Rsvd4	31:11	R	000000h	N/A (Hard-coded)
	Reserved.			
SettingsReset	10	R	1h	POR - DAFG - ULR
	Indicates if any persistent settings in this Widget have been reset. Cleared by PwrState 'Get', or a 'Set' to any Verb in this Widget.			
Rsvd3	9	R	0h	N/A (Hard-coded)
	Reserved.			

Field Name	Bits	R/W	Default	Reset
Error	8	R	0h	POR - DAFG - ULR
	Error indicator: 1 = cannot enter requested power state, 0 = no problem with requested power state.			
Rsvd2	7:6	R	0h	N/A (Hard-coded)
	Reserved.			
Act	5:4	R	3h	POR - DAFG - LR
	Actual power state of this widget.			
Rsvd1	3:2	R	0h	N/A (Hard-coded)
	Reserved.			
Set	1:0	RW	0h	POR - DAFG - LR
	Current power state setting for this widget.			

**7.28.5. Dig1Pin (NID = 20h): PinWCntrl**

Reg	Byte 4 (Bits 31:24)	Byte 3 (Bits 23:16)	Byte 2 (Bits 15:8)	Byte 1 (Bits 7:0)
Set				707h
Get	F0700h			

Field Name	Bits	R/W	Default	Reset
Rsvd2	31:7	R	0000000h	N/A (Hard-coded)
	Reserved.			
OutEn	6	RW	0h	POR - DAFG - ULR
	Output enable: 1 = enabled, 0 = disabled.			
InEn	5	RW	0h	POR - DAFG - ULR
	Input enable: 1 = enabled, 0 = disabled.			
Rsvd1	4:0	R	00h	N/A (Hard-coded)
	Reserved.			

**7.28.6. Dig1Pin (NID = 20h): UnsolResp**

Reg	Byte 4 (Bits 31:24)	Byte 3 (Bits 23:16)	Byte 2 (Bits 15:8)	Byte 1 (Bits 7:0)
Set				708h
Get	F0800h			

Field Name	Bits	R/W	Default	Reset
Rsvd2	31:8	R	000000h	N/A (Hard-coded)
	Reserved.			
En	7	RW	0h	POR - DAFG - ULR
	Unsolicited response enable (also enables Wake events for this Widget): 1 = enabled, 0 = disabled.			
Rsvd1	6	R	0h	N/A (Hard-coded)
	Reserved.			
Tag	5:0	RW	00h	POR - DAFG - ULR
	Software programmable field returned in top six bits (31:26) of every Unsolicited Response generated by this node.			

**7.28.7. Dig1Pin (NID = 20h): ChSense**

Reg	Byte 4 (Bits 31:24)	Byte 3 (Bits 23:16)	Byte 2 (Bits 15:8)	Byte 1 (Bits 7:0)
Set				709h
Get	F0900h			

Field Name	Bits	R/W	Default	Reset
PresDtct	31	R	0h	POR
	Presence detection indicator: 1 = presence detected; 0 = presence not detected.			
Rsvd	30:0	R	00000000h	N/A (Hard-coded)
	Reserved.			

**7.28.8. Dig1Pin (NID = 20h): ConfigDefault**

Reg	Byte 4 (Bits 31:24)	Byte 3 (Bits 23:16)	Byte 2 (Bits 15:8)	Byte 1 (Bits 7:0)
Set	71Fh	71Eh	71Dh	71Ch
Get	F1F00h / F1E00h / F1D00h / F1C00h			

Field Name	Bits	R/W	Default	Reset
PortConnectivity	31:30	RW	2h	POR
Port connectivity: 0h = Port complex is connected to a jack 1h = No physical connection for port 2h = Fixed function device is attached 3h = Both jack and internal device attached (info in all other fields refers to integrated device, any presence detection refers to jack)				
Location	29:24	RW	18h	POR
Location  Bits [5..4]: 0h = External on primary chassis 1h = Internal 2h = Separate chassis 3h = Other  Bits [3..0]: 0h = N/A 1h = Rear 2h = Front 3h = Left 4h = Right 5h = Top 6h = Bottom 7h-9h = Special Ah-Fh = Reserved				



# 92HD81

## SINGLE CHIP PC AUDIO SYSTEM, CODEC+SPEAKER AMPLIFIER+CAPLESS HP+LDO

Field Name	Bits	R/W	Default	Reset
Device	23:20	RW	5h	POR
	Default device: 0h = Line out 1h = Speaker 2h = HP out 3h = CD 4h = SPDIF Out 5h = Digital other out 6h = Modem line side 7h = Modem handset side 8h = Line in 9h = Aux Ah = Mic in Bh = Telephony Ch = SPDIF In Dh = Digital other in Eh = Reserved Fh = Other			
ConnectionType	19:16	RW	6h	POR
	Connection type: 0h = Unknown 1h = 1/8" stereo/mono 2h = 1/4" stereo/mono 3h = ATAPI internal 4h = RCA 5h = Optical 6h = Other digital 7h = Other analog 8h = Multichannel analog (DIN) 9h = XLR/Professional Ah = RJ-11 (modem) Bh = Combination Ch-Eh = Reserved Fh = Other			

# 92HD81

## SINGLE CHIP PC AUDIO SYSTEM, CODEC+SPEAKER AMPLIFIER+CAPLESS HP+LDO

Field Name	Bits	R/W	Default	Reset
Color	15:12	RW	0h	POR
	Color: 0h = Unknown 1h = Black 2h = Grey 3h = Blue 4h = Green 5h = Red 6h = Orange 7h = Yellow 8h = Purple 9h = Pink Ah-Dh = Reserved Eh = White Fh = Other			
Misc	11:8	RW	1h	POR
	Miscellaneous: Bits [3..1] = Reserved Bit 0 = Jack detect override			
Association	7:4	RW	7h	POR
	Default association.			
Sequence	3:0	RW	0h	POR
	Sequence.			

### 7.29. DigBeep (NID = 21h): WCap

Reg	Byte 4 (Bits 31:24)	Byte 3 (Bits 23:16)	Byte 2 (Bits 15:8)	Byte 1 (Bits 7:0)
Set				
Get	F0009h			

Field Name	Bits	R/W	Default	Reset
Rsvd3	31:24	R	00h	N/A (Hard-coded)
	Reserved.			

Field Name	Bits	R/W	Default	Reset
Type	23:20	R	7h	N/A (Hard-coded)
	Widget type: 0h = Out Converter 1h = In Converter 2h = Summing (Mixer) 3h = Selector (Mux) 4h = Pin Complex 5h = Power 6h = Volume Knob 7h = Beep Generator 8h-Eh = Reserved Fh = Vendor Defined			
Rsvd2	19:4	R	0h	N/A (Hard-coded)
	Reserved.			
AmpParOvr	3	R	1h	N/A (Hard-coded)
	Amplifier capabilities override: 1 = yes, no.			
OutAmpPrsnt	2	R	1h	N/A (Hard-coded)
	Output amp present: 1 = yes, 0 = no.			
Rsvd1	1:0	R	0h	N/A (Hard-coded)
	Reserved.			

### 7.29.1. DigBeep (NID = 21h): OutAmpCap

Reg	Byte 4 (Bits 31:24)	Byte 3 (Bits 23:16)	Byte 2 (Bits 15:8)	Byte 1 (Bits 7:0)
Set				
Get	F0012h			

Field Name	Bits	R/W	Default	Reset
Mute	31	R	1h	N/A (Hard-coded)
	Mute support: 1 = yes, 0 = no.			
Rsvd3	30:23	R	00h	N/A (Hard-coded)
	Reserved.			
StepSize	22:16	R	17h	N/A (Hard-coded)
	Size of each step in the gain range: 0 to 127 = .25dB to 32dB, in .25dB steps.			

# 92HD81

## SINGLE CHIP PC AUDIO SYSTEM, CODEC+SPEAKER AMPLIFIER+CAPLESS HP+LDO

Field Name	Bits	R/W	Default	Reset
Rsvd2	15	R	0h	N/A (Hard-coded)
	Reserved.			
NumSteps	14:8	R	03h	N/A (Hard-coded)
	Number of gains steps (number of possible settings - 1).			
Rsvd1	7	R	0h	N/A (Hard-coded)
	Reserved.			
Offset	6:0	R	03h	N/A (Hard-coded)
	Indicates which step is 0dB			

### 7.29.2. DigBeep (NID = 21h): OutAmpLeft

Reg	Byte 4 (Bits 31:24)	Byte 3 (Bits 23:16)	Byte 2 (Bits 15:8)	Byte 1 (Bits 7:0)
Set				3A0h
Get	BA000h			

Field Name	Bits	R/W	Default	Reset
Rsvd2	31:8	R	000000h	N/A (Hard-coded)
	Reserved.			
Mute	7	RW	0h	POR - DAFG - ULR
	Amp mute: 1 = muted, 0 = not muted.			
Rsvd1	6:2	R	00h	N/A (Hard-coded)
	Reserved.			
Gain	1:0	RW	1h	POR - DAFG - ULR
	Amp gain step number (see OutAmpCap parameter pertaining to this widget).			

### 7.29.3. DigBeep (NID = 21h): PwrState

Reg	Byte 4 (Bits 31:24)	Byte 3 (Bits 23:16)	Byte 2 (Bits 15:8)	Byte 1 (Bits 7:0)
Set				705h
Get	F0500h			

Field Name	Bits	R/W	Default	Reset
Rsvd4	31:11	R	000000h	N/A (Hard-coded)
	Reserved.			
SettingsReset	10	R	1h	POR - DAFG - ULR
	Indicates if any persistent settings in this Widget have been reset. Cleared by PwrState 'Get', or a 'Set' to any Verb in this Widget.			
Rsvd3	9	R	0h	N/A (Hard-coded)
	Reserved.			
Error	8	R	0h	POR - DAFG - ULR
	Error indicator: 1 = cannot enter requested power state, 0 = no problem with requested power state.			
Rsvd2	7:6	R	0h	N/A (Hard-coded)
	Reserved.			
Act	5:4	R	3h	POR - DAFG - LR
	Actual power state of this widget.			
Rsvd1	3:2	R	0h	N/A (Hard-coded)
	Reserved.			
Set	1:0	RW	0h	POR - DAFG - LR
	Current power state setting for this widget.			

**7.29.4. DigBeep (NID = 21h): Gen**

Reg	Byte 4 (Bits 31:24)	Byte 3 (Bits 23:16)	Byte 2 (Bits 15:8)	Byte 1 (Bits 7:0)
Set				70Ah
Get	F0A00h			

Field Name	Bits	R/W	Default	Reset
Rsvd	31:8	R	000000h	N/A (Hard-coded)
	Reserved.			

## 92HD81

### SINGLE CHIP PC AUDIO SYSTEM, CODEC+SPEAKER AMPLIFIER+CAPLESS HP+LDO

---

Field Name	Bits	R/W	Default	Reset
Divider	7:0	RW	00h	POR - DAFG - LR
Enable internal PC-Beep generation. Divider == 00h disables internal PC Beep generation and enables normal operation of the codec. Divider != 00h generates the beep tone on all Pin Complexes that are currently configured as outputs. The HD Audio spec states that the beep tone frequency = (48kHz HD Audio SYNC rate) / (4*Divider), producing tones from 47 Hz to 12 kHz (logarithmic scale).				

8. PINOUTS

8.1. Pin Assignment



Figure 12. Pin Assignment

## 8.2. Pin Table for 48-pin QFN

Pin Name	Pin Function	I/O	Internal Pull-up/Pull-down	48 pin location
DVDD_CORE	1.5V Digital Core Regulator Filter Cap	O(Digital)	None	1
DMIC_CLK/GPIO1	Digital Mic Clock Output/GPIO1	I/O(Digital)	Pull-Up 50k with GPIO or Pull-down 50k with Digital Mic	2
DVDD_IO	Reference Voltage (1.5V or 3.3V)	I(Digital)	None	3
DMIC0/GPIO2	Digital Mic 01 Input/GPIO2	I/O(Digital)	Pull-Up 50k with GPIO or Pull-down 50k with Digital Mic	4
SDATA_OUT	HD Audio Serial Data output from controller	I/O(Digital)	None	5
BITCLK	HD Audio Bit Clock	I(Digital)	None	6
DVSS	Digital Ground	I(Digital)	None	7
SDATA_IN	HD Audio Serial Data Input to controller	O(Digital)	None	8
DVDD	Digital Vdd= 3.3V	I(Digital)	None	9
SYNC	HD Audio Frame Sync	I(Digital)	None	10
RESET#	HD Audio Reset	I(Digital)	None	11
PCBEEP	PC Beep	I(Analog)	None	12
SENSE_A	Jack insertion detection Ports A,B,C,SPDIF0	I(Analog)	None	13
SENSE_B	Jack insertion detection Ports E,F, Mono, SPDIF1	I(Analog)	None	14
PORTE_L	Port E Left	I/O(Analog)	None	15
PORTE_R	Port E Right	I/O(Analog)	None	16
PORTF_L	Port F Left	I/O(Analog)	None	17
PORTF_R	Port F Right	I/O(Analog)	None	18
PORTC_L	Port C Left	I/O(Analog)	None	19
PORTC_R	Port C Right	I/O(Analog)	None	20
VREFFILT	Analog Virtual Ground	O(Analog)	None	21
CAP2	Reference filter Cap	O(Analog)	None	22
VREFOUT-A	Reference Voltage out drive (intended for mic bias)	O(Analog)	None	23
VREFOUT-C	Reference Voltage out drive (intended for mic bias)	O(Analog)	None	24
Mono_Out	Mono output	O(Analog)	None	25
AVSS1	Analog Ground	I(Analog)	None	26
AVDD1	Analog Vdd	I(Analog)	None	27
PORTA_L (HP0)	Port A Output Left	I/O(Analog)	None	28
PORTA_R (HP0)	Port A Output Right	I/O(Analog)	None	29
AVSS	Analog Ground	I(Analog)	None	30
PORTB_L (HP1)	Port B Output Left	I/O(Analog)	None	31
PORTB_R (HP1)	Port B Output Right	I/O(Analog)	None	32
AVSS	Analog Ground	I(Analog)	None	33
V-	Negative analog supply	O(Analog)	None	34

Table 26. Pin Table



**92HD81****SINGLE CHIP PC AUDIO SYSTEM, CODEC+SPEAKER AMPLIFIER+CAPLESS HP+LDO**

Pin Name	Pin Function	I/O	Internal Pull-up/Pull-down	48 pin location
CAP-	Chargepump cap -	O(Analog)	None	35
CAP+	Chargepump cap +	O(Analog)	None	36
VREG	Linear Regulator Output (2.5V) filter cap	O(Analog)	None	37
AVDD2	Analog Supply for VREG	I(Analog)	None	38
PVDD	Analog Supply for Class-AB amp	I(Analog)	None	39
PORTD_+L	BTL amp Left +	O(Analog)	None	40
PORTD_-L	BTL amp Left -	O(Analog)	None	41
PVSS	Analog Ground	I(Analog)	None	42
PORTD_R-	BTL amp Right -	O(Analog)	None	43
PORTD_R+	BTL amp Right +	O(Analog)	None	44
PVDD	Analog Supply for Class-D amp	I(Analog)	None	45
DMIC1/GPIO/ SPDIFOUT1	Digital Microphone input, SPDIF Output, or GPIO0	I/O(Digital)	Pull-up 60K with GPIO Pull-down 60K with DMIC or SPDIFOUT	46
EAPD	EAPD	I/O (Open Drain Digital)	Pull-up 60K	47
SPDIFOUT0	SPDIF0	O(Digital)	60K internal pull-down	48

**Table 26. Pin Table**

9. PACKAGE OUTLINE AND PACKAGE DIMENSIONS

Package dimensions are kept current with JEDEC Publication No. 95Solder Reflow Profile

9.1. 48-Pad QFN Package



Figure 13. 48QFN Package Diagram

9.2. Standard Reflow Profile Data

Note: These devices can be hand soldered at 360 °C for 3 to 5 seconds.

**FROM:** IPC / JEDEC J-STD-020C “Moisture/Reflow Sensitivity Classification for Nonhermetic Solid State Surface Mount Devices” ([www.jedec.org/download](http://www.jedec.org/download)).

Profile Feature	Pb Free Assembly
Average Ramp-Up Rate ( $T_{s_{max}} - T_p$ )	3 °C / second max
Preheat: Temperature Min ( $T_{s_{min}}$ ) Temperature Max ( $T_{s_{max}}$ ) Time ( $t_{s_{min}} - t_{s_{max}}$ )	150 °C 200 °C 60 - 180 seconds
Time maintained above: Temperature ( $T_L$ ) Time ( $t_L$ )	217 °C 60 - 150 seconds
Peak / Classification Temperature ( $T_p$ )	See “Package Classification Reflow Temperatures”
Time within 5 °C of actual Peak Temperature ( $t_p$ )	20 - 40 seconds
Ramp-Down rate	6 °C / second max
Time 25 °C to Peak Temperature	8 minutes max

Note: All temperatures refer to topside of the package, measured on the package body surface.

Table 27. Standard Reflow Profile

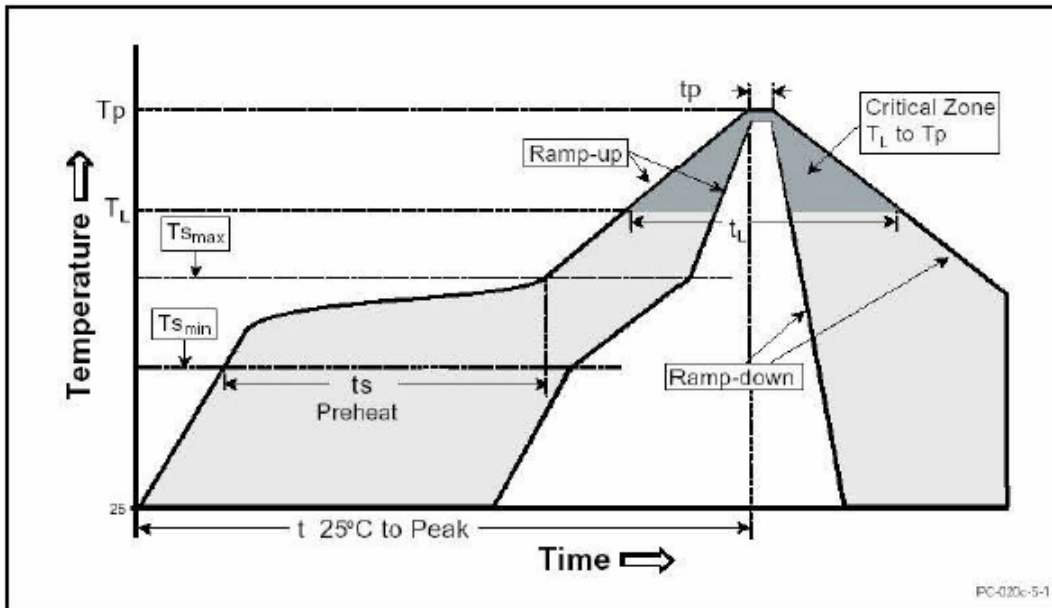

Figure 14. Solder Reflow Profile

**10. DISCLAIMER**

While the information presented herein has been checked for both accuracy and reliability, manufacturer assumes no responsibility for either its use or for the infringement of any patents or other rights of third parties, which would result from its use. No other circuits, patents, or licenses are implied. This product is intended for use in normal commercial applications. Any other applications, such as those requiring extended temperature range, high reliability, or other extraordinary environmental requirements, are not recommended without additional processing by manufacturer. Manufacturer reserves the right to change any circuitry or specifications without notice. Manufacturer does not authorize or warrant any product for use in life support devices or critical medical instruments.

## 11. DOCUMENT REVISION HISTORY

Revision	Date	Description of Change
0.5	January 25, 2008	Initial release
0.9	May 9, 2008	Added widget details. Integrated addendum sections into datasheet.
0.91	May 27, 2008	Removed low voltage part number, as not needed as the DVD_IO pin dynamically selects low voltage (1.5V) or normal (3.3V) HDA bus signaling based on what voltage is on the pin
0.92	August 6, 2008	<p>YA revision and beyond updates</p> <ul style="list-style-type: none"> <li>• BTL amp gain settings added to Section 2.18, "BTL Amplifier"</li> <li>• Corrected tables in Section 2.17, "EAPD"</li> <li>• Widget Changes in AFG (NID = 01h) <ul style="list-style-type: none"> <li>• AFGEAPD changed to have separate control bits for BTL, HP-A and HP-B</li> <li>• AFGAnaPort Verb changed to remove the GSMark control, and to provide Ports A and B with one power down control each, as opposed to each having a HP power down and a line-out power down</li> <li>• AFGAnaBeep Verb changed to add more flexible modes of operation</li> <li>• AFGAnaBTL Verb changed to add MaxVol field and remove +6db control. Other fields shifted a bit to maintain logical grouping</li> </ul> </li> </ul> <p>AFGAnaCapless Verb changed for new charge pump clock controls, as well as new test bits required by the analog</p>
0.93	October 2, 2008	<p>Corrected Mic Boost Voltages in Section 3.2</p> <p>Updated to include Aux mode Section 2.22, "Aux Audio Support (92HD81B1X only)", widget controls added at Chapter 7.4.32, "AFG (NID = 01h): AuxAudio"</p> <p>corrected part number mappings Section 1.2, "Orderable Part Numbers"</p> <p>corrected device ID mappings Section 7.3.1, "Root (NID = 00h): RevID"</p>
0.94	October 27, 2008	<p>Updated 3 widget default values for YB revision</p> <p>Chapter 7.4.28, "AFG (NID = 01h): AnaBTL YC and YD Revisions" TS Wait BITs 11:8, default 6h to 0h</p> <p>Chapter 7.4.30, "AFG (NID = 01h): AnaCapless" ChargePumpFreqBypass BIT 12 default 1h to 0h</p> <p>Chapter 7.4.30, "AFG (NID = 01h): AnaCapless" ChargePumpSplyDetOverride BIT 13 default 1h to 0h</p>
0.95	December 10, 2008	Corrected conflicting pin naming on pins 43 and 44.
0.96	January 9, 2009	<p>Updated for the YC revision</p> <p>Chapter 7.4.6, "AFG (NID = 01h): PwrStateCap" The LPD3Sup bit was renamed and default was changed</p> <p>Chapter 7.4.30, "AFG (NID = 01h): AnaCapless" ChargePumpFreqBypass BIT 12 default changed</p> <p>Chapter 7.9.12, "PortE (NID = 0Eh): ConfigDefault" and Chapter 6.3, "Pin Configuration Default Register Settings" Configuration default change</p>
0.97	January 12, 2009	<p>Updated for the WA revision</p> <p>Chapter 7.4.30, "AFG (NID = 01h): AnaCapless" ChargePumpFreqBypass BIT 12 default changed, changed m3dB field name to "Reserved" and changed p6dB field name to "AntiPopBypass."</p>
0.98	March 5, 2009	<p>Removed WA items.</p> <p>Please note YD revision has no changes in documentation from YC. All YC notes apply to YD.</p> <p>Removed 3.3V Analog option. Contact TSI for more information.</p>

**92HD81****SINGLE CHIP PC AUDIO SYSTEM, CODEC+SPEAKER AMPLIFIER+CAPLESS HP+LDO**

Revision	Date	Description of Change
0.985	April 2009	Added UA widget changes All vendor defined widgets are now reset on POR except VSPwrState Chapter 7.4.23, "AFG (NID = 01h): EAPD" AFGEAPDxxxSDMode defaults were changed to 1 Chapter 7.4.24, "AFG (NID = 01h): PortUse" AFGPortUse defaults were changed to 1 Chapter 7.4.29, "AFG (NID = 01h): AnaBTL UA Revision" AFGAnaBTL Verb updated and rearranged Chapter 7.4.30, "AFG (NID = 01h): AnaCapless" AFGAnaCaplessVRegSel definition changed, and default changed from 4h to 2h Chapter 7.8.6, "PortD (NID = 0Dh): PinWCntrl" PortDPinWCntrlOutEn bit default changed to 0 Chapter 7.4.26, "AFG (NID = 01h): AnaPort" RTZCon[2:0] field removed from the AFGAnaDAC Verb. HPILimit[1:0] field removed from the AFGAnaSply Verb. p6dB and m3dB bits removed from the AFGAnaCapless Verb, AntiPopBypass bit added to bit 0 of that Verb.
0.986	September 2009	Indicated that all UA widget comments also apply to the TA revision.
0.987	November 2009	TA revision, Port C for Input use only.
0.99	October 2010	SA revision, Port C is input and output. BTL/SD_Mode default changed. High pass filter feature added (description and widgets to control DAC0/1 ProcState and ProclIndex), updated datasheet formatting to new style. ECR15B references changed to HDA015-B.
0.995	January 2011	Updated SA revision comments for RA revision.
1.0	October 2014	Released in TSI Format

**92HD81**

**SINGLE CHIP PC AUDIO SYSTEM, CODEC+SPEAKER AMPLIFIER+CAPLESS HP+LDO**

---



[www.temposemi.com](http://www.temposemi.com)  
8627 N. MoPac Expwy Suite 130  
Austin, Texas 78759

DISCLAIMER Tempo Semiconductor, Inc. (TSI) and its subsidiaries reserve the right to modify the products and/or specifications described herein at any time and at TSI's sole discretion. All information in this document, including descriptions of product features and performance, is subject to change without notice. Performance specifications and the operating parameters of the described products are determined in the independent state and are not guaranteed to perform the same way when installed in customer products. The information contained herein is provided without representation or warranty of any kind, whether express or implied, including, but not limited to, the suitability of TSI's products for any particular purpose, an implied warranty of merchantability, or non-infringement of the intellectual property rights of others. This document is presented only as a guide and does not convey any license under intellectual property rights of TSI or any third parties.

TSI's products are not intended for use in life support systems or similar devices where the failure or malfunction of an TSI product can be reasonably expected to significantly affect the health or safety of users. Anyone using an TSI product in such a manner does so at their own risk, absent an express, written agreement by TSI.

Tempo Semiconductor, TSI and the TSI logo are registered trademarks of TSI. Other trademarks and service marks used herein, including protected names, logos and designs, are the property of TSI or their respective third party owners.

Copyright 2014. All rights reserved.



Компания «ЭлектроПласт» предлагает заключение долгосрочных отношений при поставках импортных электронных компонентов на взаимовыгодных условиях!

Наши преимущества:

- Оперативные поставки широкого спектра электронных компонентов отечественного и импортного производства напрямую от производителей и с крупнейших мировых складов;
- Поставка более 17-ти миллионов наименований электронных компонентов;
- Поставка сложных, дефицитных, либо снятых с производства позиций;
- Оперативные сроки поставки под заказ (от 5 рабочих дней);
- Экспресс доставка в любую точку России;
- Техническая поддержка проекта, помощь в подборе аналогов, поставка прототипов;
- Система менеджмента качества сертифицирована по Международному стандарту ISO 9001;
- Лицензия ФСБ на осуществление работ с использованием сведений, составляющих государственную тайну;
- Поставка специализированных компонентов (Xilinx, Altera, Analog Devices, Intersil, Interpoint, Microsemi, Aeroflex, Peregrine, Syfer, Eurofarad, Texas Instrument, Miteq, Cobham, E2V, MA-COM, Hittite, Mini-Circuits, General Dynamics и др.);

Помимо этого, одним из направлений компании «ЭлектроПласт» является направление «Источники питания». Мы предлагаем Вам помощь Конструкторского отдела:

- Подбор оптимального решения, техническое обоснование при выборе компонента;
- Подбор аналогов;
- Консультации по применению компонента;
- Поставка образцов и прототипов;
- Техническая поддержка проекта;
- Защита от снятия компонента с производства.



#### Как с нами связаться

**Телефон:** 8 (812) 309 58 32 (многоканальный)

**Факс:** 8 (812) 320-02-42

**Электронная почта:** [org@eplast1.ru](mailto:org@eplast1.ru)

**Адрес:** 198099, г. Санкт-Петербург, ул. Калинина, дом 2, корпус 4, литера А.