



LUXEON 3014

Hot-color targeted industry standard package for uniform light

LUXEON 3014 is an industry standard compatible footprint for ease of installation into existing 3014 sockets and stays consistent with a 3.0mm x 1.4mm x 0.75mm package. LUXEON 3014 is hot-color targeted at operating conditions—65°C. This low power device is an ideal choice when uniformity and reduction in spottiness is necessary for indoor designs.



FEATURES AND BENEFITS

Industry standard footprint and package offering compatibility with existing designs

1/9th ANSI micro-color binning enables tight color control

Hot-color targeted at 65°C which leads to better color accuracy

Rectangular package design allows for increased uniformity

Drive at maximum current, 120mA for superior value

PRIMARY APPLICATIONS

Indoor Area Lighting

Lamps

Specialty Lighting

– Monochrome LED

– Channel Lighting

– Signage

Table of Contents

General Product Information	2
Product Test Conditions	2
Part Number Nomenclature	2
Lumen Maintenance	2
Environmental Compliance	2
Performance Characteristics	3
Product Selection Guide	3
Optical Characteristics	3
Electrical and Thermal Characteristics	4
Absolute Maximum Ratings	4
Characteristic Curves	5
Spectral Power Distribution Characteristics	5
Light Output Characteristics	6
Forward Current Characteristics	7
Radiation Pattern Characteristics	8
Product Bin and Labeling Definitions	9
Decoding Product Bin Labeling	9
Luminous Flux Bins	9
Color Bin Definitions	10
Forward Voltage Bins	16
Mechanical Dimensions	16
Reflow Soldering Guidelines	17
JEDEC Moisture Sensitivity	17
Solder Pad Design	18
Packaging and Labeling Information	18
Pocket Tape	18
Reel	19
Moisture Barrier Bag (MBB)	20
Shipment Box	22

General Product Information

Product Test Conditions

LUXEON 3014 LEDs are tested with a 20ms monopulse of 60mA at a junction temperature, T_j , of 25°C. Forward voltage and luminous flux are binned at a T_j of 25°C, while color is not targeted at a T_j of 65°C.

Part Number Nomenclature

Part numbers for LUXEON 3014 follow the convention below:

L 1 3 0 – **A A B B Y Y** 1 4 0 0 0 0 **C**

Where:

- A A** – designates nominal CCT (22=2200K, 25=2500K, 27=2700K, 30=3000K, 35=3500K, 40=4000K, 50=5000K, 57=5700K, 65=6500K, 80=8000K, 10=10000K)
- B B** – designates minimum CRI (70=70CRI, 80=80CRI, 90=90CRI)
- Y Y** – designates platform (HE=new generation for 80CRI, 00=previous generation)
- C** – designates Lumileds internal code (1 is full distribution base part; 2, 3, etc.=shares the same base part)

Therefore, the following part number is used for a new generation LUXEON 3014 3000K 80CRI:

L 1 3 0 – **3 0 8 0 H E** 1 4 0 0 0 0 **C**

Lumen Maintenance

Please contact your local Sales Representative or Lumileds Technical Solutions Manager for more information about the long-term performance of this product.

Environmental Compliance

Lumileds LLC is committed to providing environmentally friendly products to the solid-state lighting market. LUXEON 3014 is compliant to the European Union directives on the restriction of hazardous substances in electronic equipment, namely the RoHS Directive 2011/65/EU and REACH Regulation (EC) 1907/2006. Lumileds LLC will not intentionally add the following restricted materials to its products: lead, mercury, cadmium, hexavalent chromium, polybrominated biphenyls (PBB) or polybrominated diphenyl ethers (PBDE).

Performance Characteristics

Product Selection Guide

Table 1. Product performance of LUXEON 3014 at 60mA and 30mA at test temperature.

NOMINAL CCT ^[1]	MINIMUM CRI ^[2, 3, 4]	LUMINOUS FLUX ^[3] (lm)		TYPICAL LUMINOUS EFFICACY (lm/W)	TYPICAL LUMINOUS FLUX (lm)	TYPICAL LUMINOUS EFFICACY (lm/W)	PART NUMBER
		MINIMUM	TYPICAL				
		60mA					
8000K	70	25	28	150	15	172	L130-8070001400001
10000K	70	23	27	145	14	166	L130-1070001400001
2200K	80	19	22	118	12	135	L130-2280HE1400001
2500K	80	21	24	129	12	148	L130-2580HE1400001
2700K	80	23	26	140	13	161	L130-2780HE1400001
3000K	80	23	26	140	13	161	L130-3080HE1400001
3500K	80	23	26	140	13	161	L130-3580HE1400001
4000K	80	25	28	150	15	172	L130-4080HE1400001
5000K	80	25	28	150	15	172	L130-5080HE1400001
5700K	80	25	28	150	15	172	L130-5780HE1400001
6500K	80	25	27	145	15	166	L130-6580HE1400001
2200K	90	16	18	97	9	99	L130-2290001400001
2700K	90	18	20	102	11	118	L130-2790001400001
3000K	90	19	20	102	11	118	L130-3090001400001
3500K	90	19	22	113	12	129	L130-3590001400001
4000K	90	20	23	113	12	129	L130-4090001400001
5000K	90	20	23	118	13	140	L130-5090001400001
5700K	90	20	23	118	13	140	L130-5790001400001
6500K	90	20	23	113	12	129	L130-6590001400001

Notes for Table 1:

1. Correlated color temperature is hot targeted at $T_j=65^\circ\text{C}$.
2. Lumileds maintains a tolerance of ± 2 on CRI and $\pm 6.5\%$ on luminous flux measurements.
3. Typical CRI is approximately 2 points higher than the minimum CRI specified, but this is not guaranteed.
4. For 90CRI products, $R9 \geq 50$.

Optical Characteristics

Table 2. Optical characteristics for LUXEON 3014 at 60mA, $T_j=25^\circ\text{C}$.

PART NUMBER	TYPICAL TOTAL INCLUDED ANGLE ^[1]	TYPICAL VIEWING ANGLE ^[2]
L130-xxxxx1400001	140°	116°

Notes for Table 2:

1. Total angle at which 90% of total luminous flux is captured.
2. Viewing angle is the off axis angle from the LED centerline where the luminous intensity is $\frac{1}{2}$ of the peak value.

Electrical and Thermal Characteristics

Table 3. Electrical and thermal characteristics for LUXEON 3014 at 60mA, T_j=25°C.

PART NUMBER	FORWARD VOLTAGE ^[1] (V)			TYPICAL TEMPERATURE COEFFICIENT OF FORWARD VOLTAGE (mV/°C) ^[2]	TYPICAL THERMAL RESISTANCE—JUNCTION TO SOLDER PAD (°C/W)
	MINIMUM	TYPICAL	MAXIMUM		
L130-xxxxxx1400001	2.8	3.1	3.3	-2.0 to -4.0	35

Notes for Table 3:

1. Lumileds maintains a tolerance of ±0.1V on forward voltage measurements.
2. Measured between 25°C and 85°C.

Absolute Maximum Ratings

Table 4. Absolute maximum ratings for LUXEON 3014.

PARAMETER	MAXIMUM PERFORMANCE
DC Forward Current ^[1,2]	120mA
Peak Pulsed Forward Current ^[1,3]	150mA
LED Junction Temperature ^[1] (DC & Pulse)	115°C
ESD Sensitivity (ANSI/ESDA/JEDEC JS-001-2012)	Class 2
Operating Case Temperature ^[1]	-40°C to 105°C
LED Storage Temperature	-40°C to 100°C
Soldering Temperature	JEDEC 020D 260°C
Allowable Reflow Cycles	3
Reverse Voltage (V _{reverse})	-5V

Notes for Table 4:

1. Proper current derating must be observed to maintain the junction temperature below the maximum allowable junction temperature.
2. Residual periodic variations due to power conversion from alternating current (AC) to direct current (DC), also called "ripple," are acceptable if the following conditions are met:
 - The frequency of the ripple current is 100Hz or higher
 - The average current for each cycle does not exceed the maximum allowable DC forward current
 - The maximum amplitude of the ripple does not exceed 15% of the maximum allowable DC forward current
3. At 10% duty cycle with pulse width of 10ms.

Characteristic Curves

Spectral Power Distribution Characteristics

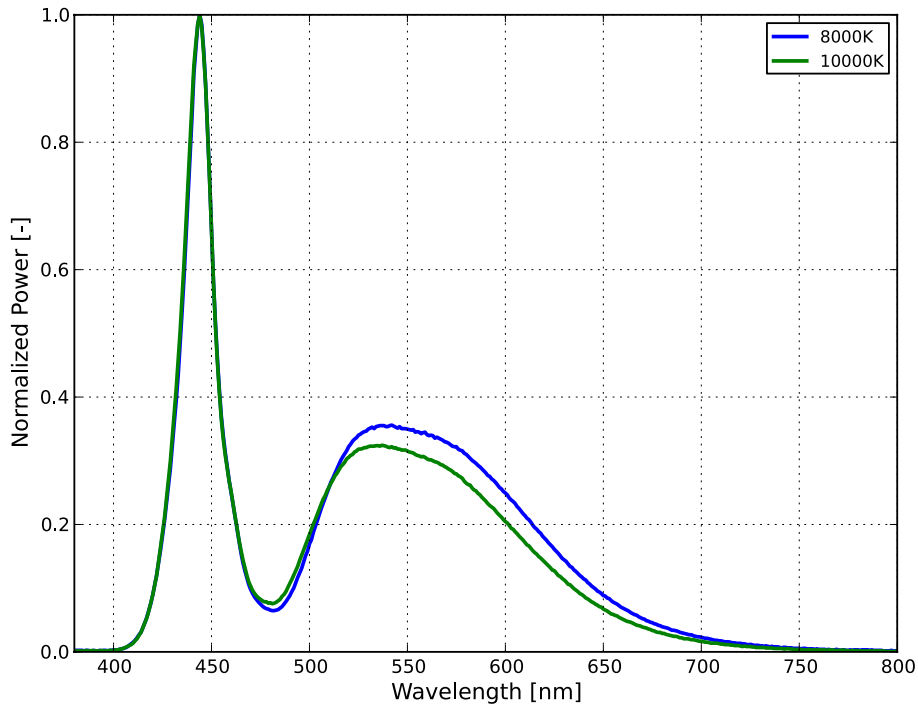

Figure 1a. Typical normalized power vs. wavelength for L130-xx70001400001 at 60mA, $T_j=25^\circ\text{C}$.

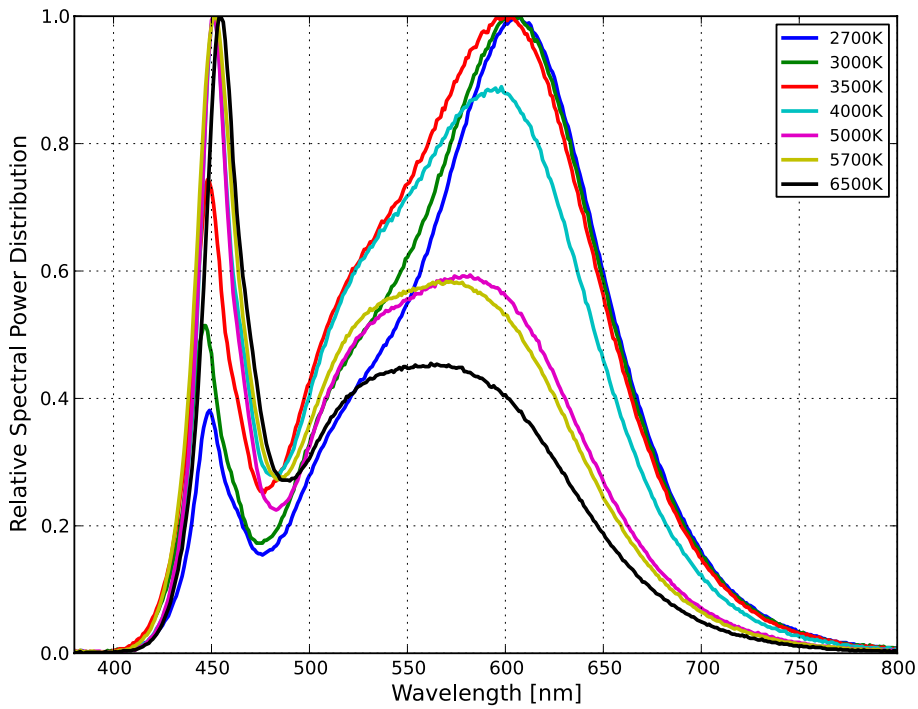

Figure 1b. Typical normalized power vs. wavelength for L130-xx80HE1400001 at 60mA, $T_j=25^\circ\text{C}$.

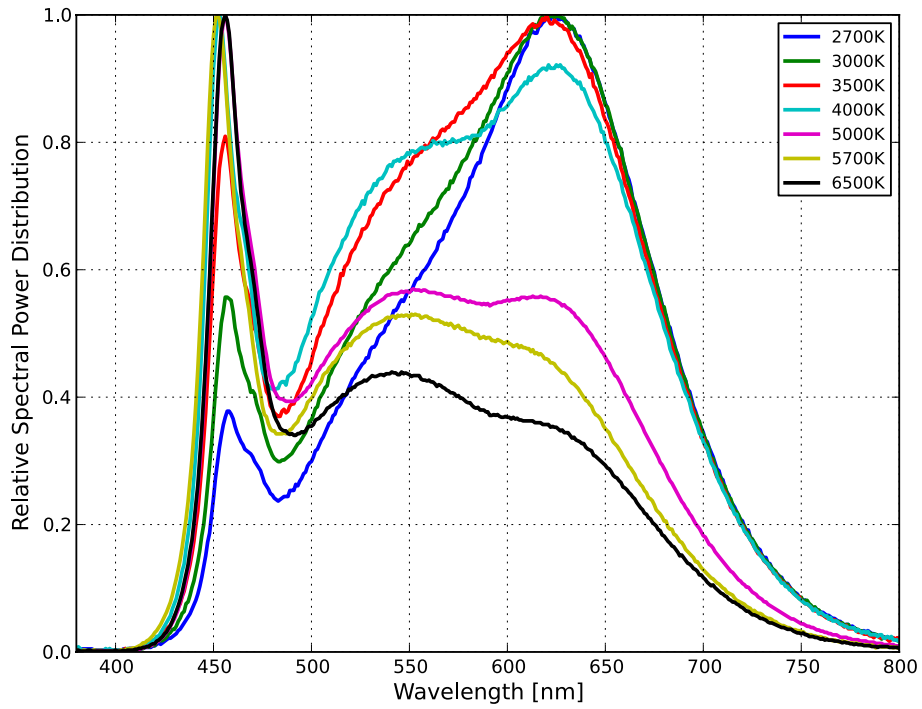

Figure 1c. Typical normalized power vs. wavelength for L130-xx90001400001 at 60mA, T_j=25°C.

Light Output Characteristics

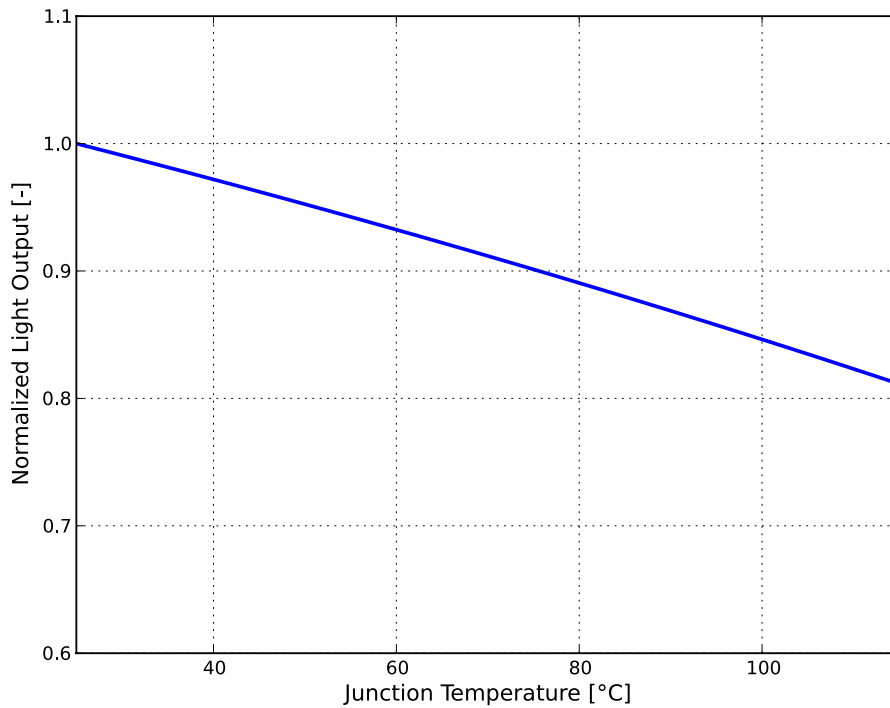

Figure 2a. Typical normalized light output vs. junction temperature for L130-xxxxxx1400001 at 60mA.

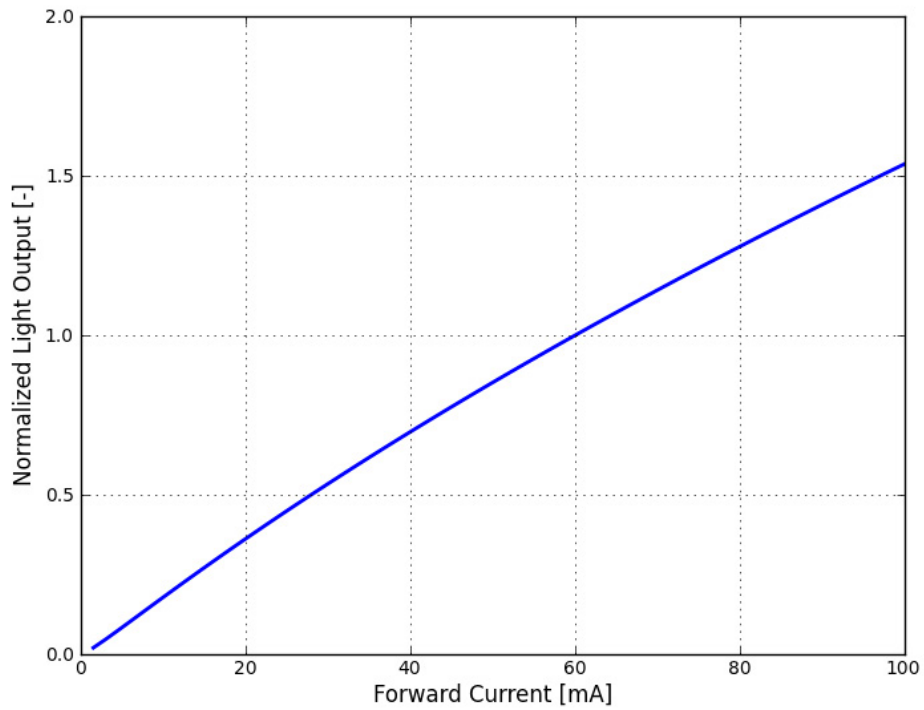

Figure 2b. Typical normalized light output vs. forward current for L130-xxxxxx1400001 at $T_j=25^\circ\text{C}$.

Forward Current Characteristics

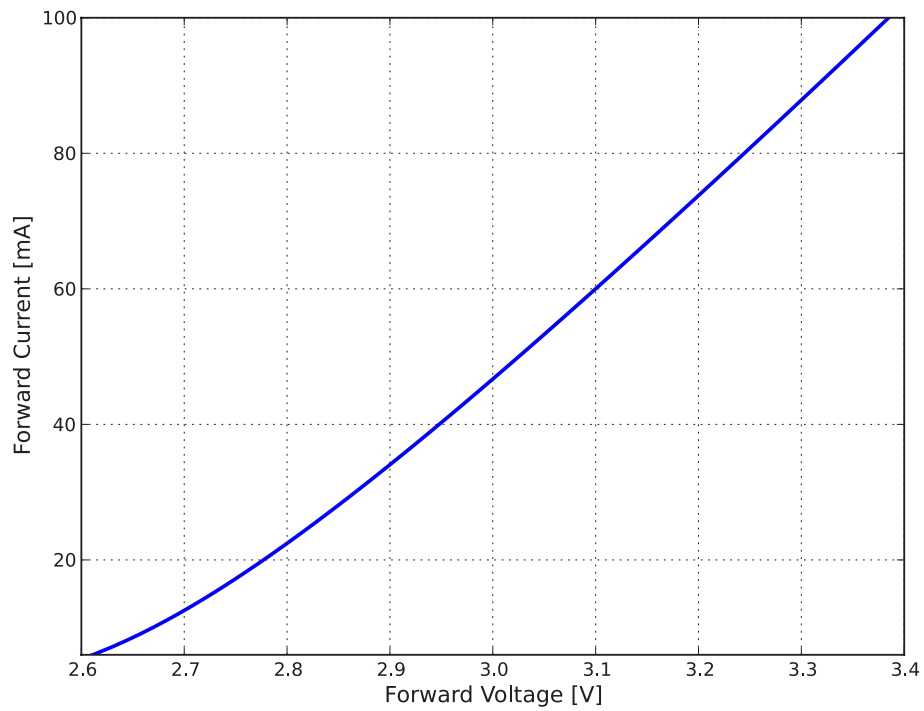

Figure 3. Typical forward current vs. forward voltage for L130-xxxxxx1400001 at $T_j=25^\circ\text{C}$.

Radiation Pattern Characteristics

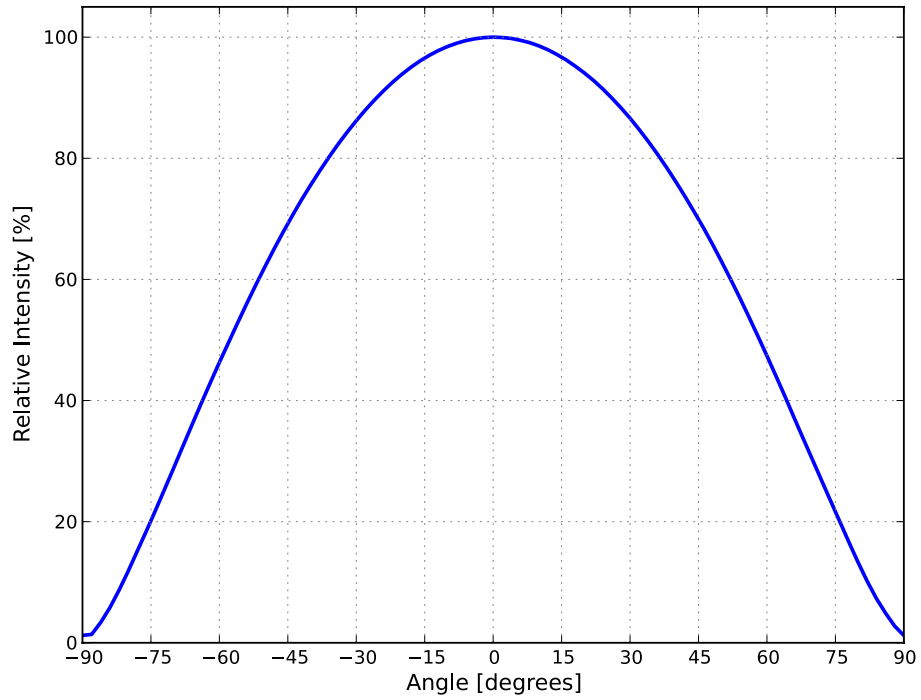

Figure 4. Typical radiation pattern for L130-xxxxxx1400001 at 60mA, $T_j=25^\circ\text{C}$.

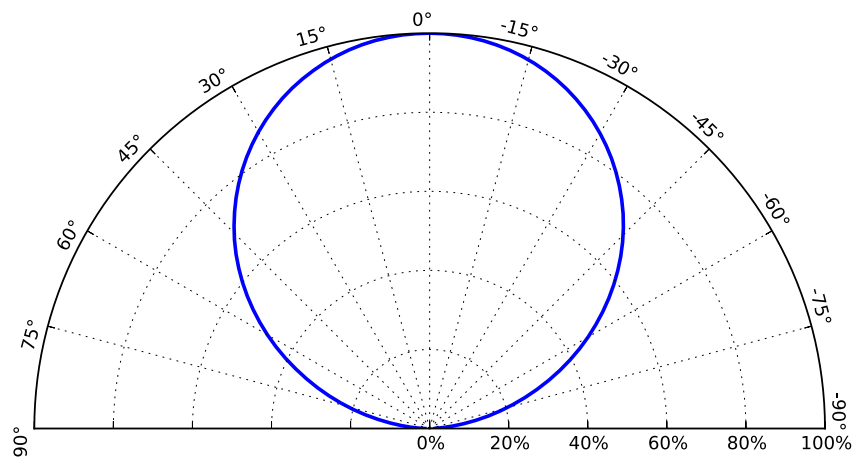

Figure 5. Typical polar radiation pattern for L130-xxxxxx1400001 at 60mA, $T_j=25^\circ\text{C}$.

Product Bin and Labeling Definitions

Decoding Product Bin Labeling

In the manufacturing of semiconductor products, there are variations in performance around the average values given in the technical datasheet. For this reason, Lumileds bins LED components for luminous flux or radiometric power, color point, peak or dominant wavelength and forward voltage.

LUXEON 3014 LEDs are labeled using a 5-digit alphanumeric CAT code following the format below:

A x B C D

- A x** – designates luminous flux bin (example: G0=19 to 21 lumens, J1=25 to 27 lumens)
- B C** – designates color bin (example: 7D, 7E, 7F, 7G, 7H, 7J, 7K, 7L, 7M for 3000K parts)
- D** – designates forward voltage bin (example: T=2.80 to 2.90V, W=3.00 to 3.10V)

Therefore, a LUXEON 3014 with a lumen range of 25 to 27, color bin of 7D and a forward voltage range of 2.80 to 2.90V has the following CAT code:

J 1 7 D T

Luminous Flux Bins

Table 5 lists the standard luminous flux bins for LUXEON 3014 emitters. Although several bins are outlined, product availability in a particular bin varies by production run and by product performance. Not all bins are available in all CCTs.

Table 5. Luminous flux bin definitions for LUXEON 3014 at 60mA, T_j=25°C.

BIN	LUMINOUS FLUX ⁽¹⁾ (lm)	
	MINIMUM	MAXIMUM
E0	15	17
F0	17	19
G0	19	21
H1	21	23
H2	23	25
J1	25	27
J2	27	29
K1	29	31
K2	31	33

Notes for Table 5:

1. Lumileds maintains a tolerance of ±6.5% on luminous flux measurements.

Color Bin Definitions

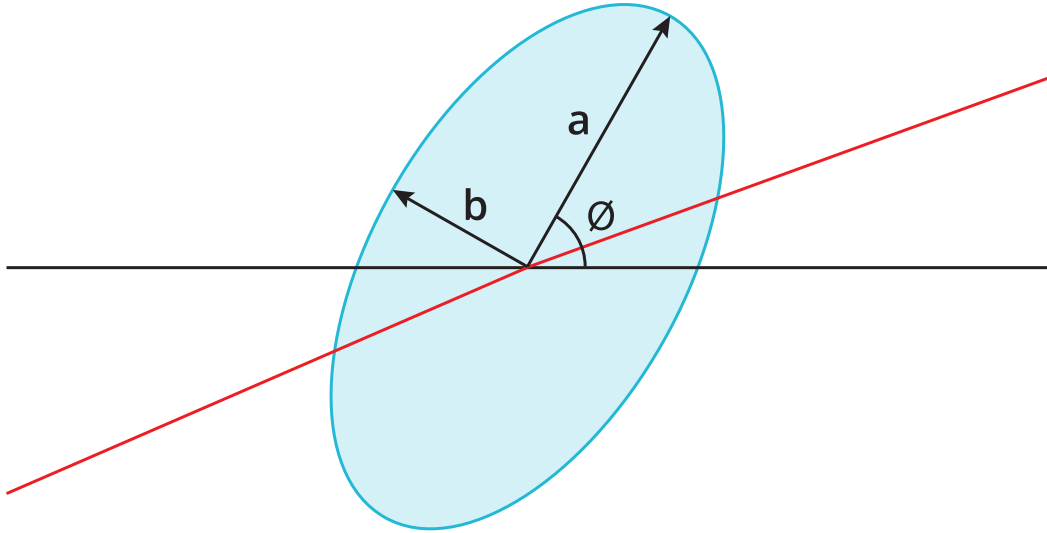

Figure 6. 3-, 4- and 5-step MacAdam ellipse illustration for Table 6.

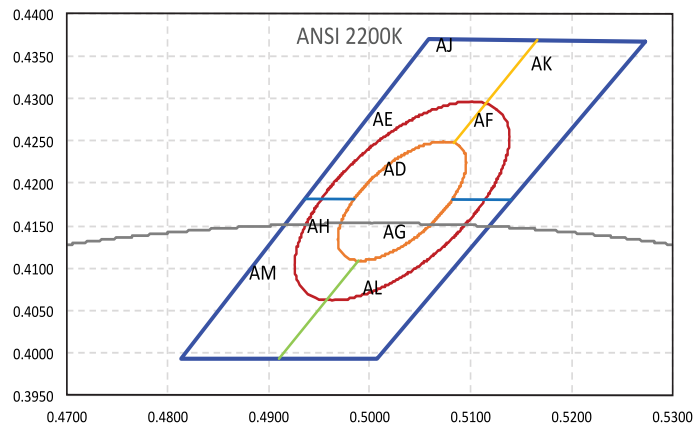

Figure 7a. Color bin structure for LUXEON 3014 2200K, hot-color targeted at $T_j=65^\circ\text{C}$.

Table 6a. 3- and 5-step MacAdam ellipse color bin definitions for L130-22xxHE1400001 at 60mA, hot-color targeted at $T_j=65^\circ\text{C}$.

NOMINAL CCT	COLOR SPACE	CENTER POINT (cx, cy)	MAJOR AXIS, a	MINOR AXIS, b	ELLIPSE ROTATION ANGLE, θ
2200K	Single 3-step MacAdam ellipse	(0.5037, 0.4142)	0.0072	0.0042	51.0°
2200K	Single 5-step MacAdam ellipse	(0.5037, 0.4142)	0.0120	0.0070	51.0°

Notes for Table 6b:

1. Lumileds maintains a tolerance of ± 0.005 on x and y coordinates in the CIE 1931 color space.

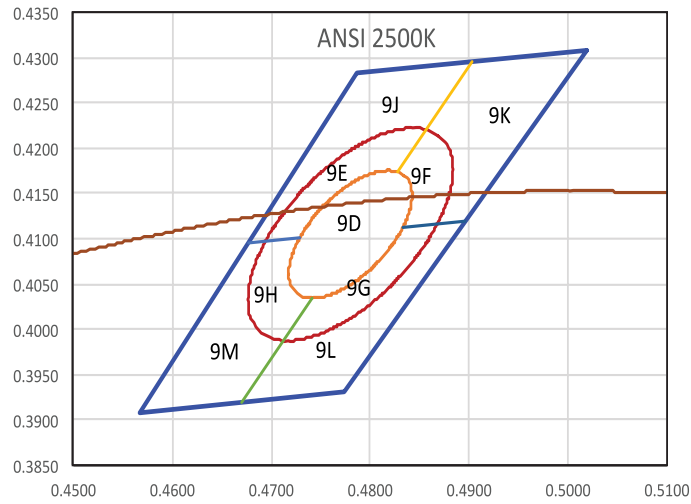

Figure 7b. Color bin structure for LUXEON 3014 2500K, hot-color targeted at $T_j=65^\circ\text{C}$.

Table 6b. 3- and 5-step MacAdam ellipse color bin definitions for L130-25xxHE1400001 at 60mA, hot-color targeted at $T_j=65^\circ\text{C}$.

NOMINAL CCT	COLOR SPACE	CENTER POINT (cx, cy)	MAJOR AXIS, a	MINOR AXIS, b	ELLIPSE ROTATION ANGLE, θ
2500K	Single 3-step MacAdam ellipse	(0.4753, 0.4127)	0.0075	0.0042	53.0°
2500K	Single 5-step MacAdam ellipse	(0.4753, 0.4127)	0.0125	0.0070	53.0°

Notes for Table 6b:

1. Lumileds maintains a tolerance of ± 0.005 on x and y coordinates in the CIE 1931 color space.

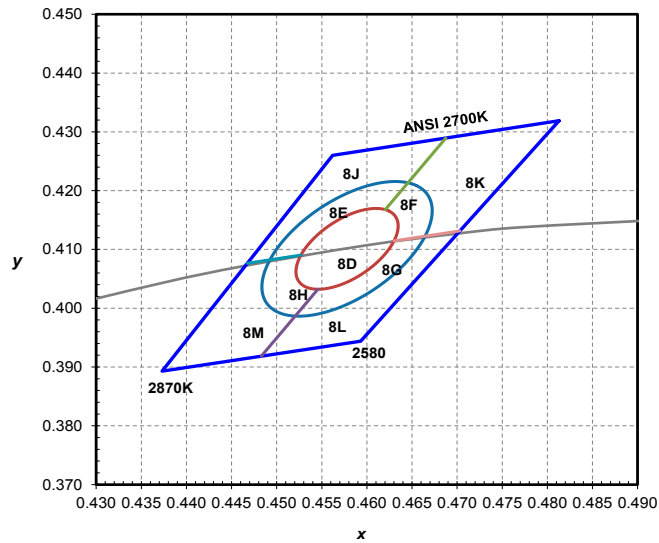

Figure 7c. Color bin structure for LUXEON 3014 2700K, hot-color targeted at $T_j=65^\circ\text{C}$.

Table 6c. 3- and 5-step MacAdam ellipse color bin definitions for L130-27xxxx1400001 at 60mA, hot-color targeted at $T_j=65^\circ\text{C}$.

NOMINAL CCT	COLOR SPACE	CENTER POINT (cx, cy)	MAJOR AXIS, a	MINOR AXIS, b	ELLIPSE ROTATION ANGLE, θ
2700K	Single 3-step MacAdam ellipse	(0.4578, 0.4101)	0.00810	0.00420	53.70°
2700K	Single 5-step MacAdam ellipse	(0.4578, 0.4101)	0.01350	0.00700	53.70°

Notes for Table 6c:

1. Lumileds maintains a tolerance of ± 0.005 on x and y coordinates in the CIE 1931 color space.

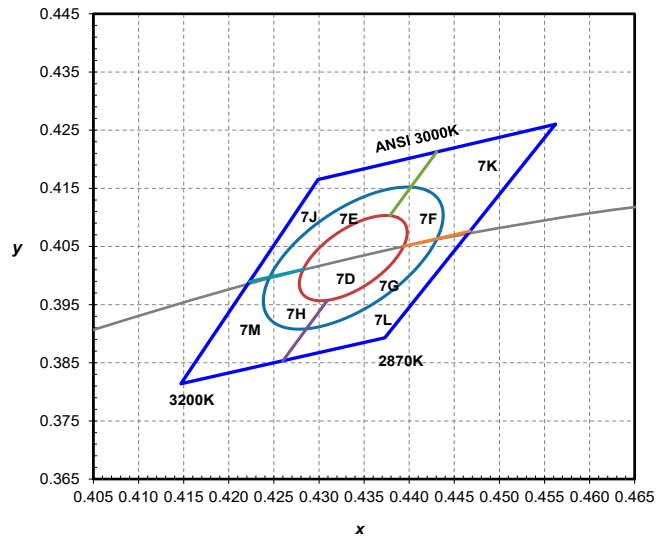

Figure 7d. Color bin structure for LUXEON 3014 3000K, hot-color targeted at $T_j=65^\circ\text{C}$.

Table 6d. 3- and 5-step MacAdam ellipse color bin definitions for L130-30xxxx1400001 at 60mA, hot-color targeted at $T_j=65^\circ\text{C}$.

NOMINAL CCT	COLOR SPACE	CENTER POINT (cx, cy)	MAJOR AXIS, a	MINOR AXIS, b	ELLIPSE ROTATION ANGLE, θ
3000K	Single 3-step MacAdam ellipse	(0.4338, 0.4030)	0.00834	0.00408	53.22°
3000K	Single 5-step MacAdam ellipse	(0.4338, 0.4030)	0.01390	0.00680	53.22°

Notes for Table 6d:

1. Lumileds maintains a tolerance of ± 0.005 on x and y coordinates in the CIE 1931 color space.

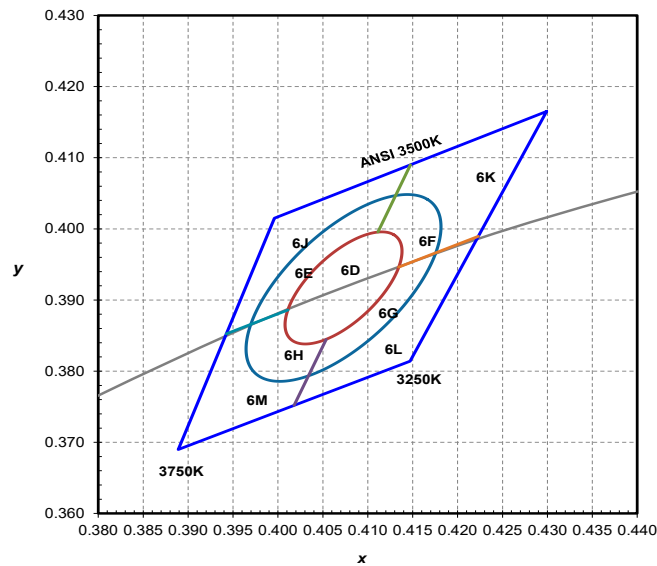

Figure 7e. Color bin structure for LUXEON 3014 3500K, hot-color targeted at $T_j=65^\circ\text{C}$.

Table 6e. 3- and 5-step MacAdam ellipse color bin definitions for L130-35xxxx1400001 at 60mA, hot-color targeted at $T_j=65^\circ\text{C}$.

NOMINAL CCT	COLOR SPACE	CENTER POINT (cx, cy)	MAJOR AXIS, a	MINOR AXIS, b	ELLIPSE ROTATION ANGLE, θ
3500K	Single 3-step MacAdam ellipse	(0.4073, 0.3917)	0.00927	0.00414	54.00°
3500K	Single 5-step MacAdam ellipse	(0.4073, 0.3917)	0.01545	0.00690	54.00°

Notes for Table 6e:

1. Lumileds maintains a tolerance of ± 0.005 on x and y coordinates in the CIE 1931 color space.

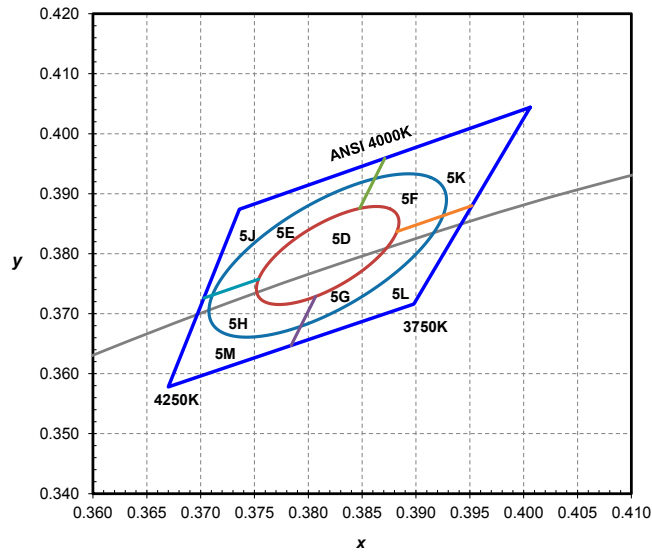

Figure 7f. Color bin structure for LUXEON 3014 4000K, hot-color targeted at $T_j=65^\circ\text{C}$.

Table 6f. 3- and 5-step MacAdam ellipse color bin definitions for L130-40xxxx1400001 at 60mA, hot-color targeted at $T_j=65^\circ\text{C}$.

NOMINAL CCT	COLOR SPACE	CENTER POINT (cx, cy)	MAJOR AXIS, a	MINOR AXIS, b	ELLIPSE ROTATION ANGLE, θ
4000K	Single 3-step MacAdam ellipse	(0.3818, 0.3797)	0.00939	0.00402	53.72°
4000K	Single 5-step MacAdam ellipse	(0.3818, 0.3797)	0.01565	0.00670	53.72°

Notes for Table 6f:

1. Lumileds maintains a tolerance of ± 0.005 on x and y coordinates in the CIE 1931 color space.

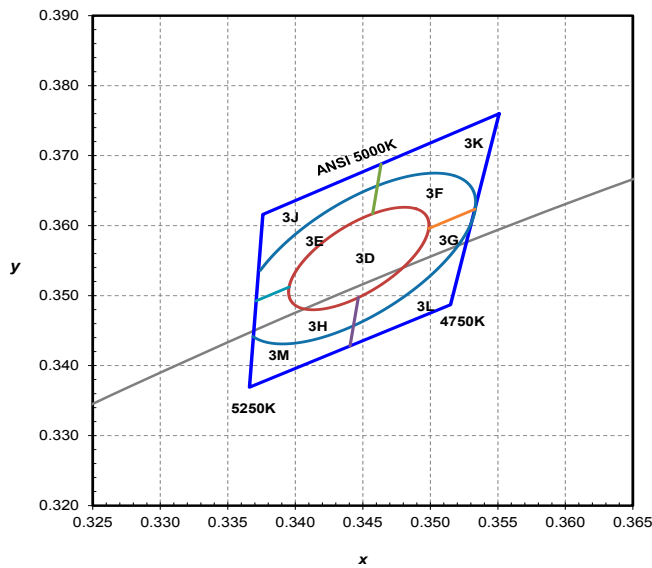

Figure 7g. Color bin structure for LUXEON 3014 5000K, hot-color targeted at $T_j=65^\circ\text{C}$.

Table 6g. 3- and 5-step MacAdam ellipse color bin definitions for L130-50xxxx1400001 at 60mA, hot-color targeted at $T_j=65^\circ\text{C}$.

NOMINAL CCT	COLOR SPACE	CENTER POINT (cx, cy)	MAJOR AXIS, a	MINOR AXIS, b	ELLIPSE ROTATION ANGLE, θ
5000K	Single 3-step MacAdam ellipse	(0.3447, 0.3553)	0.00822	0.00354	59.62°
5000K	Single 5-step MacAdam ellipse	(0.3447, 0.3553)	0.01370	0.00590	59.62°

Notes for Table 6g:

1. Lumileds maintains a tolerance of ± 0.005 on x and y coordinates in the CIE 1931 color space.

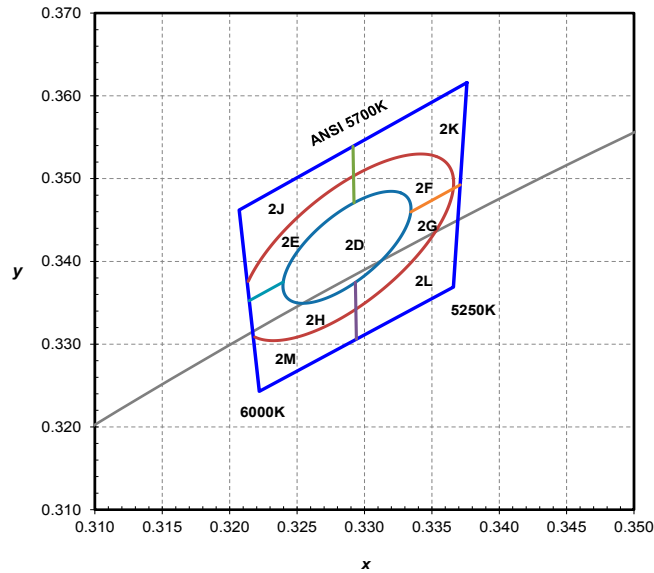

Figure 7h. Color bin structure for LUXEON 3014 5700K, hot-color targeted at $T_j=65^\circ\text{C}$.

Table 6h. 3- and 5-step MacAdam ellipse color bin definitions for L130-57xxxx1400001 at 60mA, hot-color targeted at $T_j=65^\circ\text{C}$.

NOMINAL CCT	COLOR SPACE	CENTER POINT (cx, cy)	MAJOR AXIS, a	MINOR AXIS, b	ELLIPSE ROTATION ANGLE, θ
5700K	Single 3-step MacAdam ellipse	(0.3287, 0.3417)	0.00746	0.00320	59.09°
5700K	Single 5-step MacAdam ellipse	(0.3287, 0.3417)	0.01243	0.00533	59.09°

Notes for Table 6h:

1. Lumileds maintains a tolerance of ± 0.005 on x and y coordinates in the CIE 1931 color space.

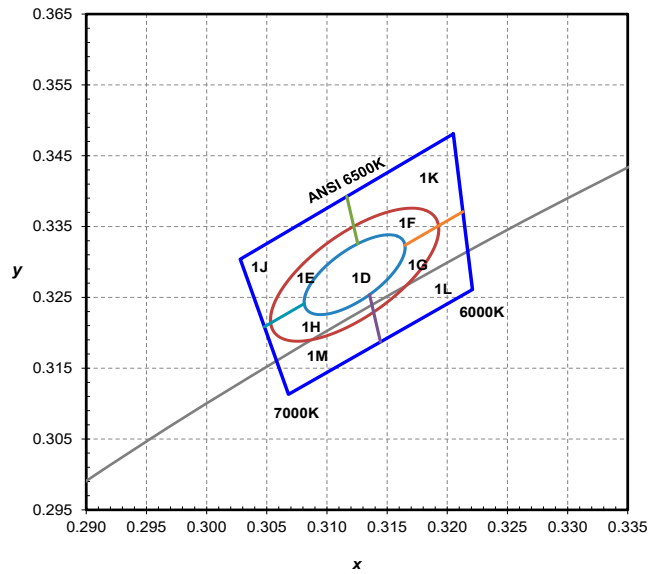

Figure 7i. Color bin structure for LUXEON 3014 6500K, hot-color targeted at $T_j=65^\circ\text{C}$.

Table 6i. 3- and 5-step MacAdam ellipse color bin definitions for L130-65xxxx1400001 at 60mA, hot-color targeted at $T_j=65^\circ\text{C}$.

NOMINAL CCT	COLOR SPACE	CENTER POINT (cx, cy)	MAJOR AXIS, a	MINOR AXIS, b	ELLIPSE ROTATION ANGLE, θ
6500K	Single 3-step MacAdam ellipse	(0.3123, 0.3282)	0.00669	0.00285	58.57°
6500K	Single 5-step MacAdam ellipse	(0.3123, 0.3282)	0.01115	0.00475	58.57°

Notes for Table 6i:

1. Lumileds maintains a tolerance of ± 0.005 on x and y coordinates in the CIE 1931 color space.

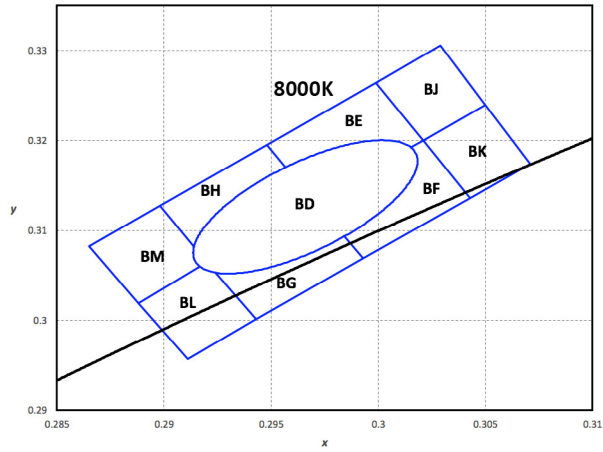

Figure 7j. Color bin structure for LUXEON 3014 8000K, hot-color targeted at $T_j=65^\circ\text{C}$.

Table 6j. 4-step MacAdam ellipse color bin definitions for L130-8070001400001 at 60mA, hot-color targeted at $T_j=65^\circ\text{C}$.

NOMINAL CCT	COLOR SPACE	CENTER POINT (cx, cy)	MAJOR AXIS, a	MINOR AXIS, b	ELLIPSE ROTATION ANGLE, θ
8000K	Single 4-step MacAdam ellipse	(0.2966, 0.3126)	0.00844	0.00334	58.64°

Notes for Table 6j:

- Lumileds maintains a tolerance of ± 0.005 on x and y coordinates in the CIE 1931 color space.

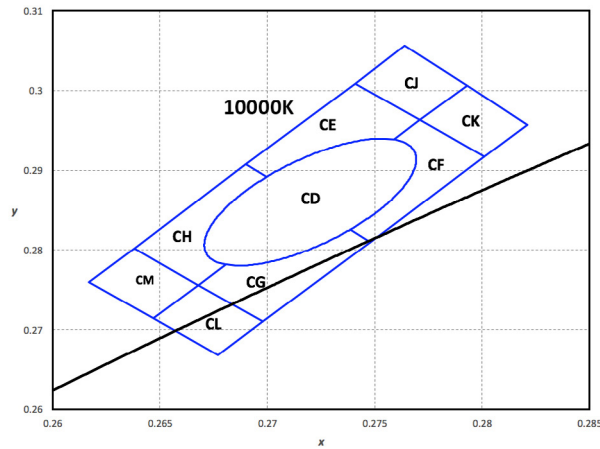

Figure 7k. Color bin structure for LUXEON 3014 10000K, hot-color targeted at $T_j=65^\circ\text{C}$.

Table 6k. 4-step MacAdam ellipse color bin definitions for L130-1070001400001 at 60mA, hot-color targeted at $T_j=65^\circ\text{C}$.

NOMINAL CCT	COLOR SPACE	CENTER POINT (cx, cy)	MAJOR AXIS, a	MINOR AXIS, b	ELLIPSE ROTATION ANGLE, θ
10000K	Single 4-step MacAdam ellipse	(0.2720, 0.2860)	0.00877	0.00332	63.28°

Notes for Table 6k:

- Lumileds maintains a tolerance of ± 0.005 on x and y coordinates in the CIE 1931 color space.

Forward Voltage Bins

Table 7. Forward voltage bin definitions for LUXEON 3014 at 60mA, T_j=25°C.

BIN	FORWARD VOLTAGE ⁽¹⁾ (V)	
	MINIMUM	MAXIMUM
T	2.80	2.90
V	2.90	3.00
W	3.00	3.10
X	3.10	3.20
Y	3.20	3.30
Z	3.30	3.40

Notes for Table 7:

1. Lumileds maintains a tolerance of ±0.1V on forward voltage measurements.

Mechanical Dimensions

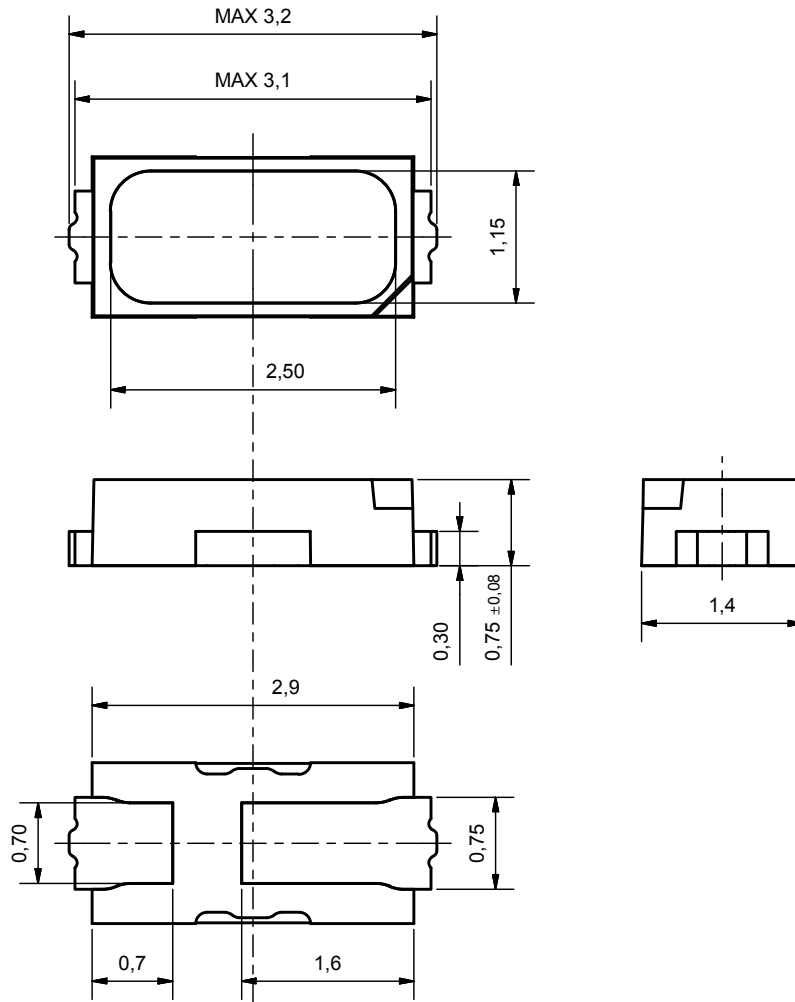

Figure 8. Mechanical dimensions for LUXEON 3014.

Notes for Figure 8:

1. Drawings are not to scale.
2. All dimensions are in millimeters.

Reflow Soldering Guidelines

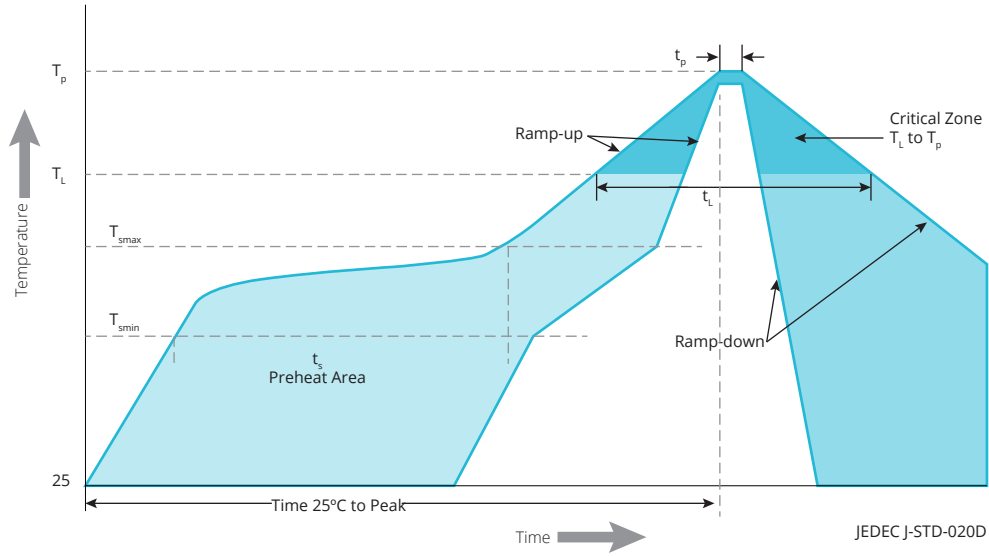

Figure 9. Visualization of the acceptable reflow temperature profile as specified in Table 8.

Table 8. Reflow profile characteristics for LUXEON 3014.

PROFILE FEATURE	LEAD-FREE ASSEMBLY
Preheat Minimum Temperature (T_{smin})	150°C
Preheat Maximum Temperature (T_{smax})	200°C
Preheat Time (t_{smin} to t_{smax})	60 to 120 seconds
Ramp-Up Rate (T_L to T_p)	3°C / second maximum
Liquidus Temperature (T_L)	217°C
Time Maintained Above Temperature T_L (t_t)	60 to 150 seconds
Peak / Classification Temperature (T_p)	260°C
Time Within 5°C of Actual Temperature (t_p)	20 to 40 seconds
Ramp-Down Rate (T_p to T_L)	6°C / second maximum
Time 25°C to Peak Temperature	8 minutes maximum

JEDEC Moisture Sensitivity

Table 9. Moisture sensitivity levels for LUXEON 3014.

LEVEL	FLOOR LIFE		SOAK REQUIREMENTS STANDARD	
	TIME	CONDITIONS	TIME	CONDITIONS
3	168 Hours	≤30°C / 60% RH	192 Hours +5 / -0	30°C / 60% RH

Solder Pad Design

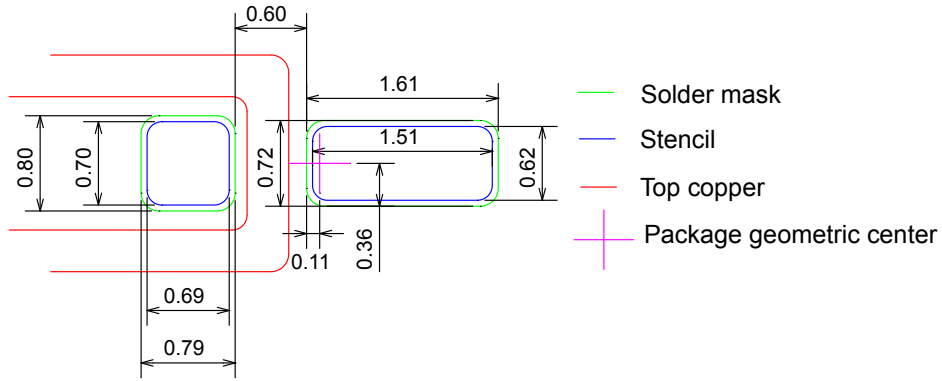

Figure 10. Recommended PCB solder pad layout for LUXEON 3014.

- Notes for Figure 10:
1. Drawings are not to scale.
 2. All dimensions are in millimeters.

Packaging and Labeling Information

There are two labeling formats used on the reel, moisture barrier bag (MBB) and shipment box. Either Format A or Format B is used throughout all the packaging steps. Lumileds uses CODE 128 barcode font on all the labels.

Pocket Tape

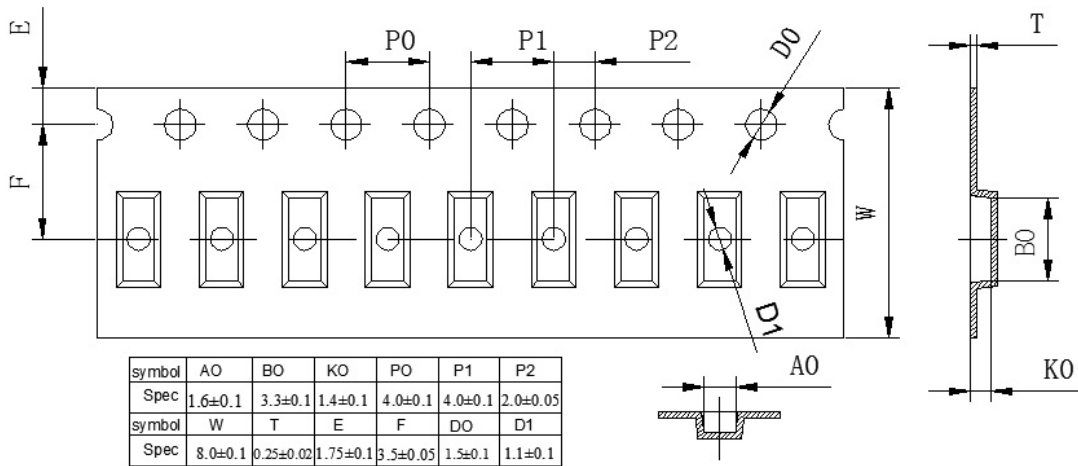

Figure 11. Pocket tape dimensions for LUXEON 3014.

- Notes for Figure 11:
1. Drawings are not to scale.
 2. All dimensions are in millimeters.

Reel

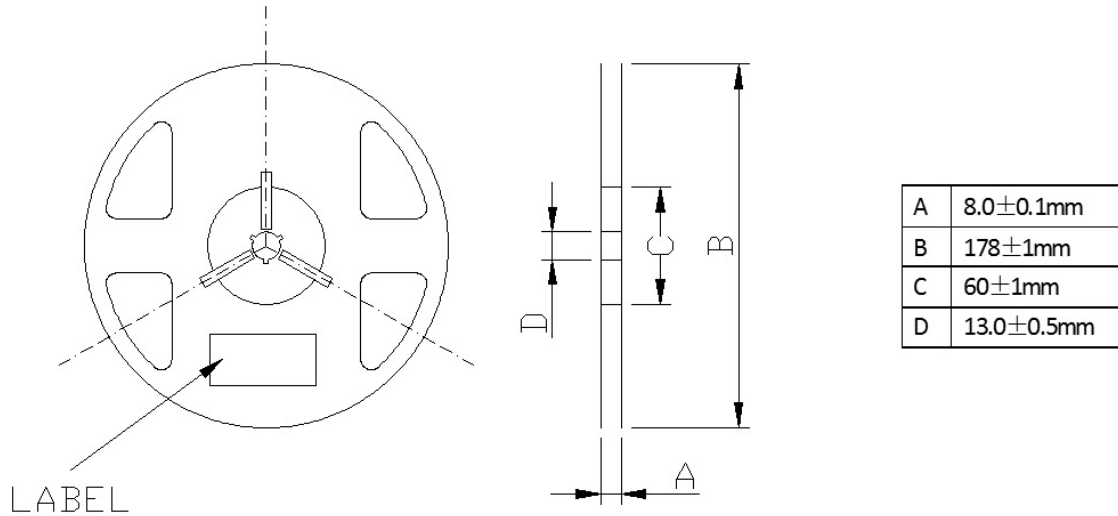

Figure 12. Reel dimensions for LUXEON 3014.

- Notes for Figure 12:
1. Drawings are not to scale.
 2. All dimensions are in millimeters.

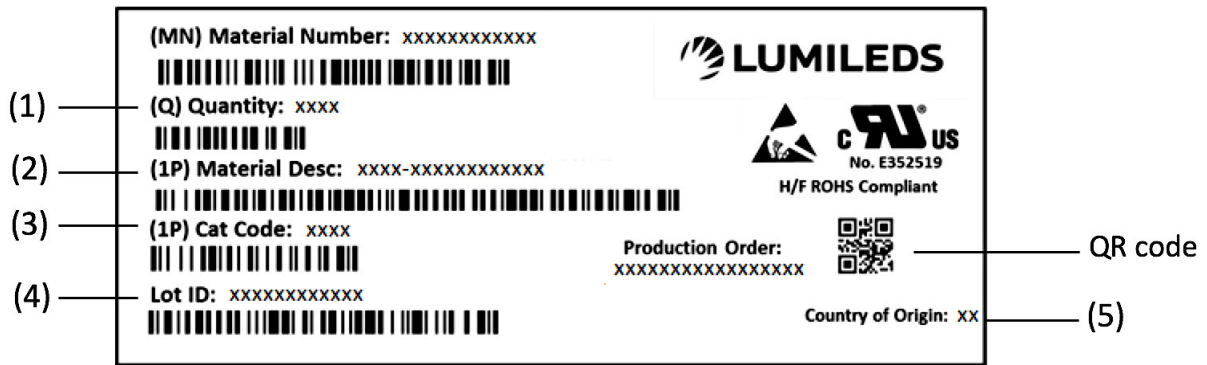

Figure 13a: Example of reel label format A.



Figure 13b. Example of reel label format B.

- Notes for Figure 13a and Figure 13b — Reel Label descriptions for customer use:
 QR code and all other field labels not described are for Lumileds internal use only.
1. Number of LED emitters in a reel.
 2. Lumileds part number.
 3. Product category code.
 4. Unique production lot identification number. First six numbers refer to manufacturing date code in YYMMDD format. This number is required for traceability purpose.
 5. Country code of origin of manufacturing of parts. E.g. MY for Malaysia, CN for China according to ISO 3166-1 alpha-2 document.
 6. Lumileds product name. Lumileds part number is provided in MBB label Format B #2 as shown in Figure 25c.

Moisture Barrier Bag (MBB)

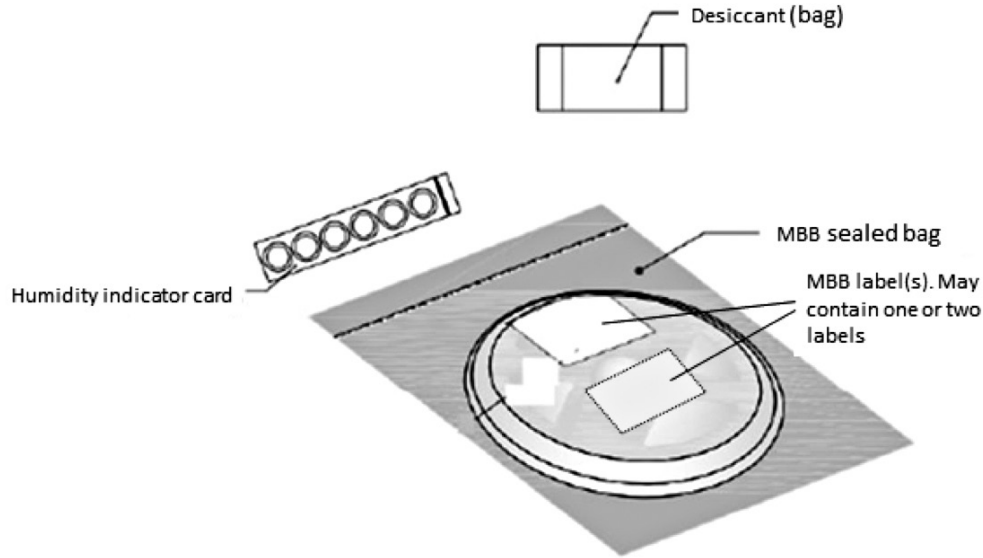

Figure 14. Illustration of typical Moisture Barrier Bag (MBB) packaging of a LUXEON emitter reel. MBB consists of humidity indicator card, desiccant bag, MBB label(s) and LED emitter reel. The MBB package is air-tight sealed per JEDEC J-STD-033C.

Notes for Figure 14:
1. Drawings are not to scale.

There are two MBB labels attached (#1 and #2). The peeled off label (Figure 28) must be detached and affixed to the reel upon opening of the MBB package.

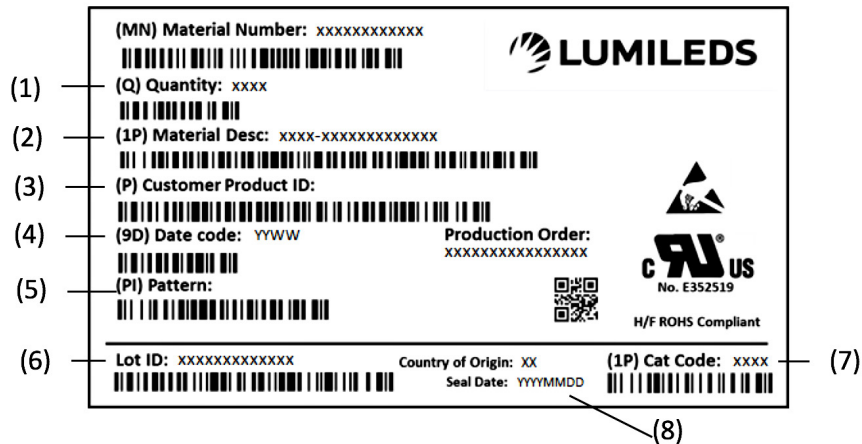

Figure 15a. Example of MBB label format A.

Notes for Figure 15a — MBB label descriptions for customer use:
QR code and all other field labels not described are for Lumileds internal use only.

1. Number of LED emitters in a reel.
2. Lumileds part number.
3. Customer part number for custom requests only.
4. LED test date in YYWW format.
5. Kitting information for custom request only.
6. Unique production lot identification number. First six numbers refer to manufacturing date code in YYMMDD format. This number is required for traceability purpose.
7. Product category code.
8. Date in which MBB was sealed in YYYYMMDD format.

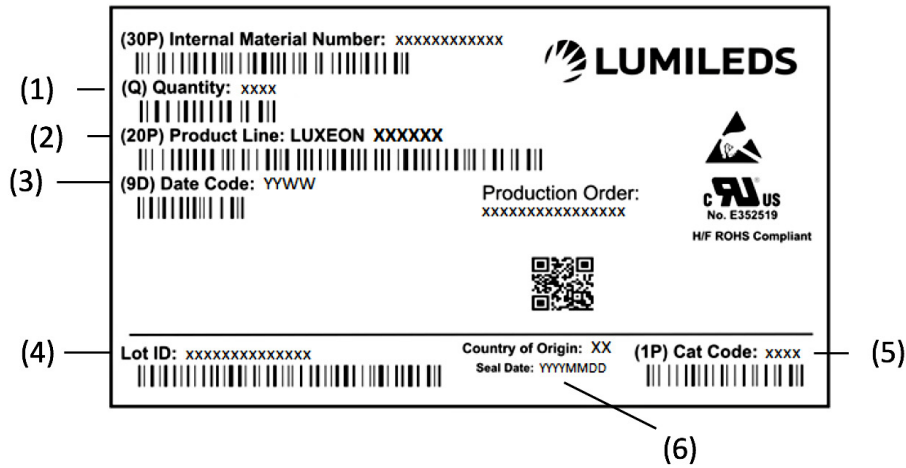

Figure 15b. Example of MBB label format B #1.

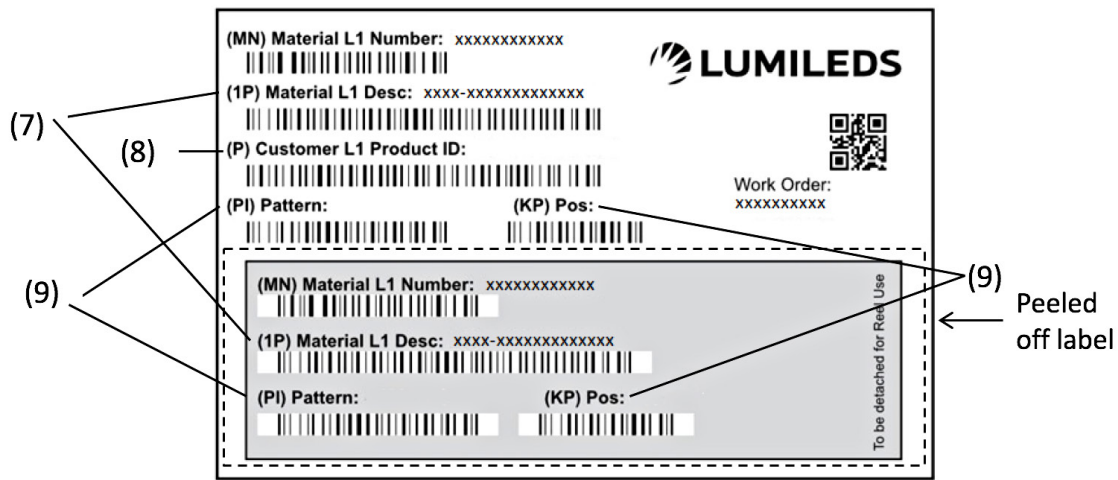

Figure 15c. Example of MBB label format B #2.

Notes for Figure 15b and Figure 15c — MBB label descriptions for customer use:

QR code and all other field labels not described are for Lumileds internal use only.

1. Number of LED emitters in a reel.
2. Lumileds product name.
3. LED test date in YYWW format.
4. Unique production lot identification number. First six numbers refer to manufacturing date code in YYYYMMDD format. This number is required for traceability purpose.
5. Product category code.
6. Date in which MBB was sealed in YYYYMMDD format.
7. Lumileds part number.
8. Customer part number for custom requests only.
9. Kitting information for custom request only.

Shipment Box

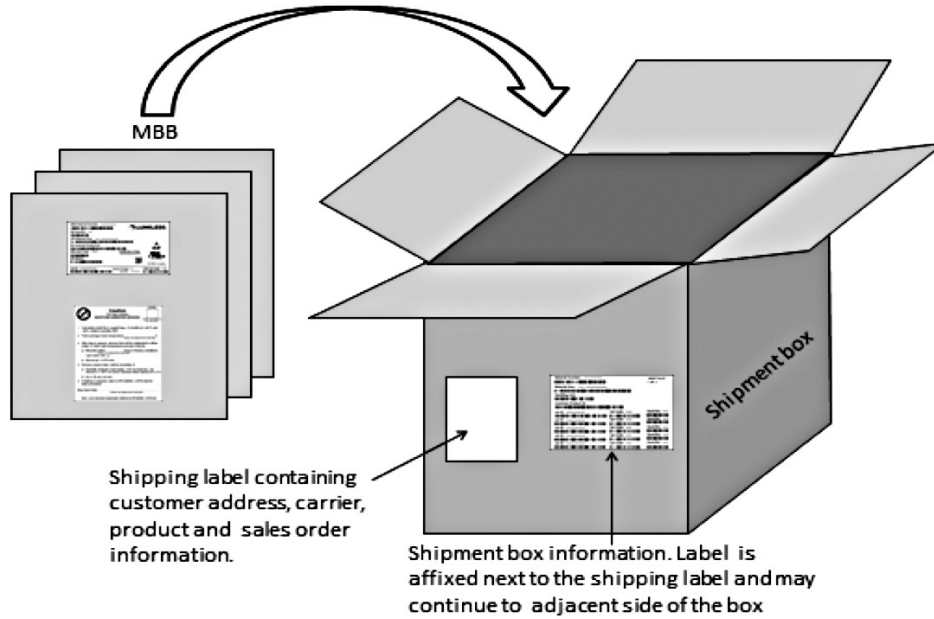

Figure 16. Illustration of MBBs packing into a shipment box.

Notes for Figure 16:
 1. Drawings are not to scale.



Figure 17a. Example of shipment box label format A.

Notes for Figure 17a — Shipment box label descriptions for customer use:
 All other field labels not described are for Lumileds internal use only.
 1. Lumileds part number.
 2. Customer part number for custom requests only.
 3. Maximum of 10 reels printed per label. For example, if there are 21 reels in a shipment box, there will be 3 labels printed.

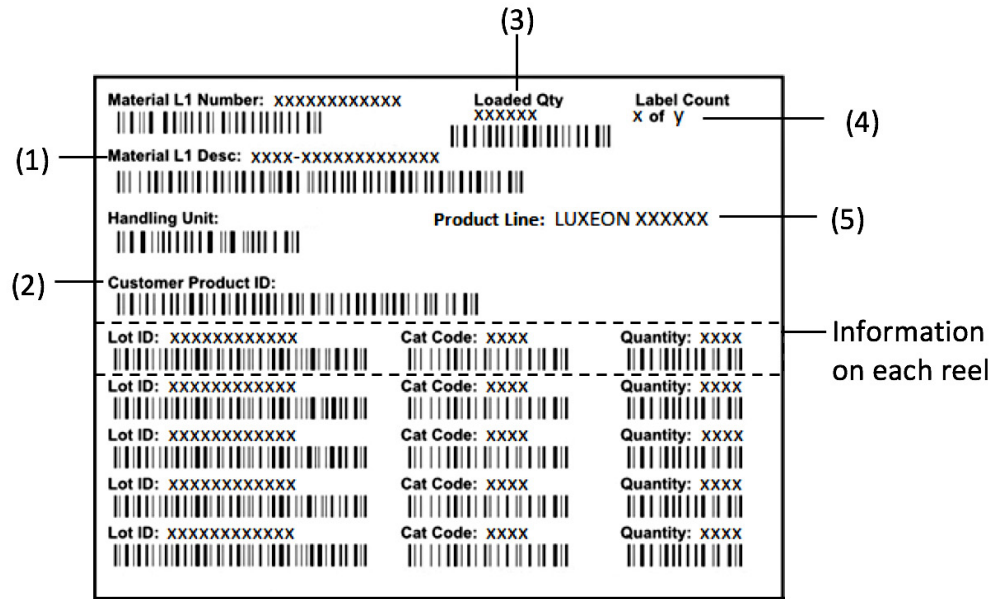

Figure 17b. Example of shipment box label format B.

Notes for Figure 17b — Shipment box label descriptions for customer use:

All other field labels not described are for Lumileds internal use only.

1. Lumileds part number.
2. Customer part number for custom requests only.
3. Total number of LED emitters in a shipment box.
4. Maximum of 10 reels printed per label. For example, if there are 21 reels in a shipment box, there will be 3 labels printed.
5. Lumileds product name.

About Lumileds

Lumileds is the global leader in light engine technology. The company develops, manufactures and distributes groundbreaking LEDs and automotive lighting products that shatter the status quo and help customers gain and maintain a competitive edge.

With a rich history of industry “firsts,” Lumileds is uniquely positioned to deliver lighting advancements well into the future by maintaining an unwavering focus on quality, innovation and reliability.

To learn more about our portfolio of light engines, visit lumileds.com.



©2017 Lumileds Holding B.V. All rights reserved.
LUXEON is a registered trademark of the Lumileds Holding B.V.
in the United States and other countries.
lumileds.com

Neither Lumileds Holding B.V. nor its affiliates shall be liable for any kind of loss of data or any other damages, direct, indirect or consequential, resulting from the use of the provided information and data. Although Lumileds Holding B.V. and/or its affiliates have attempted to provide the most accurate information and data, the materials and services information and data are provided “as is,” and neither Lumileds Holding B.V. nor its affiliates warrants or guarantees the contents and correctness of the provided information and data. Lumileds Holding B.V. and its affiliates reserve the right to make changes without notice. You as user agree to this disclaimer and user agreement with the download or use of the provided materials, information and data.



Компания «ЭлектроПласт» предлагает заключение долгосрочных отношений при поставках импортных электронных компонентов на взаимовыгодных условиях!

Наши преимущества:

- Оперативные поставки широкого спектра электронных компонентов отечественного и импортного производства напрямую от производителей и с крупнейших мировых складов;
- Поставка более 17-ти миллионов наименований электронных компонентов;
- Поставка сложных, дефицитных, либо снятых с производства позиций;
- Оперативные сроки поставки под заказ (от 5 рабочих дней);
- Экспресс доставка в любую точку России;
- Техническая поддержка проекта, помощь в подборе аналогов, поставка прототипов;
- Система менеджмента качества сертифицирована по Международному стандарту ISO 9001;
- Лицензия ФСБ на осуществление работ с использованием сведений, составляющих государственную тайну;
- Поставка специализированных компонентов (Xilinx, Altera, Analog Devices, Intersil, Interpoint, Microsemi, Aeroflex, Peregrine, Syfer, Eurofarad, Texas Instrument, Miteq, Cobham, E2V, MA-COM, Hittite, Mini-Circuits, General Dynamics и др.);

Помимо этого, одним из направлений компании «ЭлектроПласт» является направление «Источники питания». Мы предлагаем Вам помощь Конструкторского отдела:

- Подбор оптимального решения, техническое обоснование при выборе компонента;
- Подбор аналогов;
- Консультации по применению компонента;
- Поставка образцов и прототипов;
- Техническая поддержка проекта;
- Защита от снятия компонента с производства.



Как с нами связаться

Телефон: 8 (812) 309 58 32 (многоканальный)

Факс: 8 (812) 320-02-42

Электронная почта: org@eplast1.ru

Адрес: 198099, г. Санкт-Петербург, ул. Калинина, дом 2, корпус 4, литера А.