

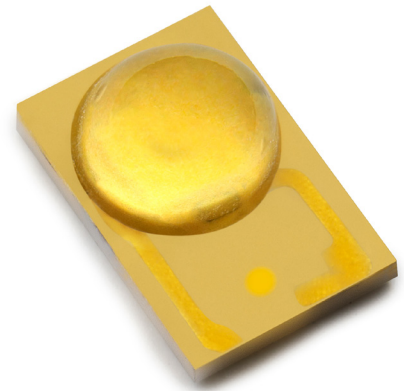

# LUXEON Rebel PLUS

## The original high-power LED

LUXEON Rebel PLUS is designed with the highest possible efficacy and light output from an industry standard 4530 package with a 2.5mm<sup>2</sup> dome. With hot testing and color binning, every LUXEON Rebel PLUS is tested and specified at real world operating conditions — 85°C. Our exceptional color control enables design simplicity for luminaire manufacturers and ensures that they can be confident in color consistency from LED to LED. The superior quality of light, light output, and real world efficacy enable leading performance and efficient solution development in a wide variety of outdoor and industry lighting segments.



### FEATURES AND BENEFITS

3- & 5-step MacAdam ellipse: *Freedom from Binning* for superior quality of light

Ability to deliver high Lm/\$ for Indoor applications

Low typical  $V_f \sim 2.8V$

Small optical source size

Full range of CCTS in 80CRI minimum

LM-80 test report available

### PRIMARY APPLICATIONS

High Bay & Low Bay

Outdoor

# Table of Contents

General Information .....	2
Part Number Nomenclature .....	2
Lumen Maintenance .....	2
Environmental Compliance .....	2
Product Selection & Optical Characteristics .....	3
Electrical Characteristics .....	4
Absolute Maximum Ratings .....	4
JEDEC Moisture Sensitivity .....	4
Reflow Soldering Characteristics .....	5
Mechanical Dimensions .....	6
Pad Configuration .....	7
Solder Pad Design .....	7
Typical Light Output Characteristics over Temperature .....	8
Typical Forward Current Characteristics .....	9
Typical Radiation Patterns .....	10
Emitter Pocket Tape Packaging .....	11
Emitter Reel Packaging .....	12
Product Binning and Labeling .....	13
Luminous Flux and Forward Voltage Bins .....	14
LUXEON Rebel PLUS 3-step and 5-step MacAdam Ellipse Color Definition .....	15

# General Information

## Part Number Nomenclature

LUXEON Rebel PLUS emitters are tested and binned “hot” under conditions comparable to those found in “real-world” lighting products. The test conditions for LUXEON Rebel PLUS are 350mA D.C. with junction temperature at 85°C.

The part number designation for the LUXEON Rebel PLUS emitters is explained as follows:

LX18 - P1XX - Y

Where:

8 — designates minimum CRI performance (value 8 = 80 minimum)

P — designates radiation pattern (value P for Lambertian)

1 — 80 CRI min designation

XX — designates nominal ANSI CCT (value 27 = 2700K, 30 = 3000K, 35 = 3500K, 40 = 4000K, and 50 = 5000K)

Y — 3 for 3-step and 5-step MacAdam Ellipse

## Lumen Maintenance

LUXEON Rebel PLUS products are tested in compliance with LM-80. Please visit [www.lumileds.com](http://www.lumileds.com) or contact your local Lumileds Technical Solutions Manager for TM-21 extrapolations or other support.

## Environmental Compliance

Lumileds is committed to providing environmentally friendly products to the solid-state lighting market. LUXEON Rebel PLUS is compliant to the European Union directives on the restriction of hazardous substances in electronic equipment, namely the RoHS and REACH directives. Lumileds will not intentionally add the following restricted materials to the LUXEON Rebel PLUS: lead, mercury, cadmium, hexavalent chromium, polybrominated biphenyls (PBB) or polybrominated diphenyl ethers (PBDE).

# Product Selection & Optical Characteristics

## Product Selection Guide for LUXEON Rebel PLUS Emitters Junction Temperature = 85°C

Table 1.

Part Number	Nominal ANSI CCT	Performance @ 350mA Test Current			Typ. Luminous Flux (lm)		Typ. Forward Voltage (V)		Typ. Efficacy (lm/W)	
		CRI Min	Min Luminous Flux (lm)	Test Condition °C	350mA	700mA	350mA	700mA	350mA	700mA
LX18-P127-Y	2700K	80	80	85	85	156	2.76	2.85	88	78
LX18-P130-Y	3000K	80	85	85	95	166	2.76	2.85	98	83
LX18-P135-Y	3500K	80	90	85	98	172	2.76	2.85	101	86
LX18-P140-Y	4000K	80	90	85	103	180	2.76	2.85	107	90
LX18-P150-Y	5000K	80	95	85	106	186	2.76	2.85	110	93

Notes for Table 1:

1. Minimum luminous flux performance within published operating conditions. Lumileds maintains a tolerance of  $\pm 6.5\%$  on luminous flux measurements and  $\pm 2$  on CRI measurements.
2. Lumileds maintains a tolerance of  $\pm 0.06V$  on forward voltage measurements.

## Optical Characteristics

### LUXEON Rebel PLUS at Test Current <sup>[1]</sup>, Junction Temperature = 85°C

Table 2.

Nominal CCT	Part Number	Color Temperature CCT Typical <sup>[2]</sup>	Typ Total Included Angle <sup>[2]</sup> (degrees) $\theta_{0.90V}$	Typ Viewing Angle <sup>[3]</sup> (degrees) $2\theta_{1/2}$
2700K	LX18-P127-Y	2725K	160	120
3000K	LX18-P130-Y	3045K	160	120
3500K	LX18-P135-Y	3465K	160	120
4000K	LX18-P140-Y	3985K	160	120
5000K	LX18-P150-Y	5028K	160	120

Notes for Table 2:

1. Test current is 350mA D.C. for all LX18-P1xx emitters.
2. Total angle at which 90% of total luminous flux is captured.
3. Viewing angle is the off axis angle from lamp centerline where the luminous intensity is 1/2 of the peak value.

# Electrical Characteristics

## Electrical Characteristics at 350mA for LUXEON Rebel PLUS, Junction Temperature = 85°C

Table 3.

Nominal ANSI CCT	Forward Voltage $V_f$ <sup>[1]</sup> (V)		Typical Temperature Coefficient of Forward Voltage <sup>[2]</sup> (mV/°C) $\Delta V_f / \Delta T_J$	Typical Thermal Resistance Junction to Thermal Pad (°C/W) $R_{\theta_{J-C}}$
	Min	Max		
2700K	2.5	3.00	-1.0 to -3.0	9
3000K	2.5	3.00	-1.0 to -3.0	9
3500K	2.5	3.00	-1.0 to -3.0	9
4000K	2.5	3.00	-1.0 to -3.0	9
5000K	2.5	3.00	-1.0 to -3.0	9

Notes for Table 3:

1. Lumileds maintains a tolerance of  $\pm 0.06V$  on forward voltage measurements.
2. Measured between  $T_J = 25^\circ C$  and  $T_J = 110^\circ C$  at  $I_f = 350mA$ .

## Absolute Maximum Ratings

Table 4.

Parameter	Maximum Performance
DC Forward Current (mA) <sup>[2]</sup>	1000
Peak Pulsed Forward Current <sup>[3]</sup>	1000
ESD Sensitivity	< 8000V Human Body Model (HBM) Class 3A JESD22-A114-E
LED Junction Temperature <sup>[1]</sup>	150°C
Operating Case Temperature at 700mA	-40°C - 135°C
Storage Temperature	-40°C - 135°C
Soldering Temperature	JEDEC 020c 260°C
Allowable Reflow Cycles	3
Reverse Voltage ( $V_r$ )	LUXEON Rebel PLUS LEDs are not designed to be driven in reverse bias

Notes for Table 4:

1. Proper current derating must be observed to maintain junction temperature below the maximum. For additional information on thermal measurement guidelines please refer to Application Brief AB33.
2. Residual periodic variations due to power conversion from alternating current (AC) to direct current (DC), also called "ripple", with frequencies  $\geq 100$  Hz and amplitude  $\leq 300mA$  are acceptable, assuming the average current throughout each cycle does not exceed 1000mA.
3. Pulsed operation with a peak drive current of 1000mA is acceptable if the pulse on-time is  $\leq 5$  ms per cycle and the duty cycle is  $\leq 50\%$ .

## JEDEC Moisture Sensitivity

Table 5.

Level	Floor Life		Soak Requirements	
			Standard	
	Time	Conditions	Time	Conditions
1	Unlimited	$\leq 30^\circ C / 85\% RH$	168 Hrs. + 5 / -0 Hrs.	85°C / 85% RH

# Reflow Soldering Characteristics

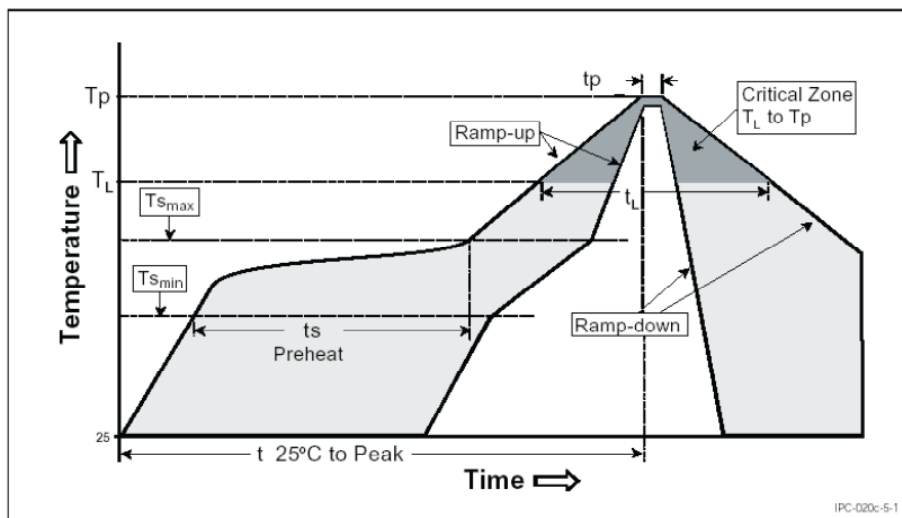

Figure 1. Temperature Profile for Table 6.

Table 6.

Profile Feature	Lead Free Assembly
Average Ramp-Up Rate ( $T_{s_{max}}$ to $T_p$ )	3°C / second max
Preheat Temperature Min ( $T_{s_{min}}$ )	150°C
Preheat Temperature Max ( $T_{s_{max}}$ )	200°C
Preheat Time ( $t_{s_{min}}$ to $t_{s_{max}}$ )	60 - 180 seconds
Temperature ( $T_L$ )	217°C
Time Maintained Above Temperature $T_L$	60 - 150 seconds
Peak / Classification Temperature ( $T_p$ )	260°C
Time Within 5°C of Actual Peak Temperature ( $t_p$ )	20 - 40 seconds
Ramp-Down Rate	6°C / second max
Time 25°C to Peak Temperature	8 minutes max

Note for Table 6:

1. All temperatures refer to the application Printed Circuit Board (PCB), measured on the surface adjacent to the package body.

# Mechanical Dimensions

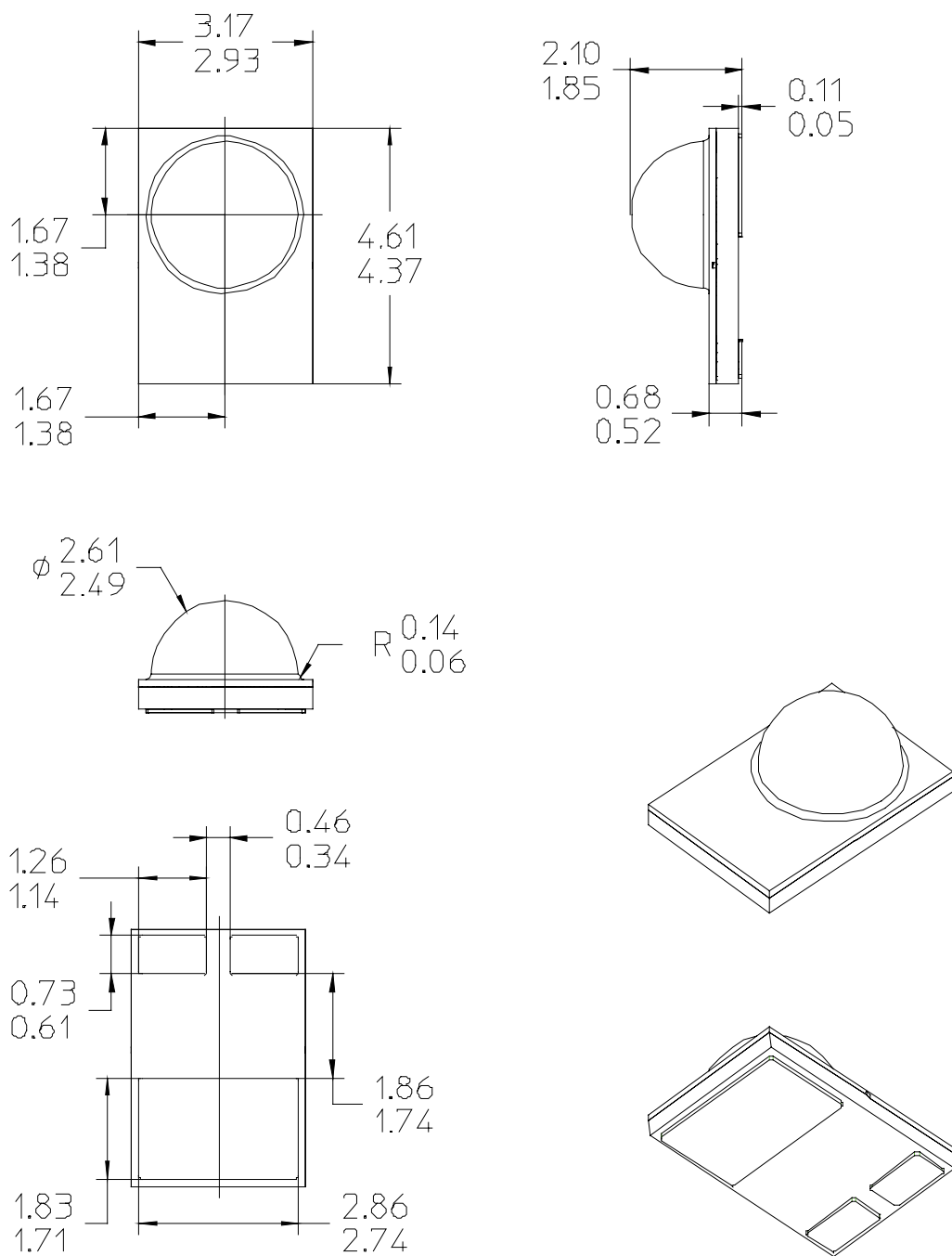

Figure 2. Package outline drawing.

Notes for Figure 2:

1. Do not handle the device by the lens, as the lens or the interior of the device can be damaged by excessive force to the lens.
2. Drawings not to scale. All dimensions are in millimeters.
3. The thermal pad is electrically isolated from the anode and cathode contact pads.

## Pad Configuration

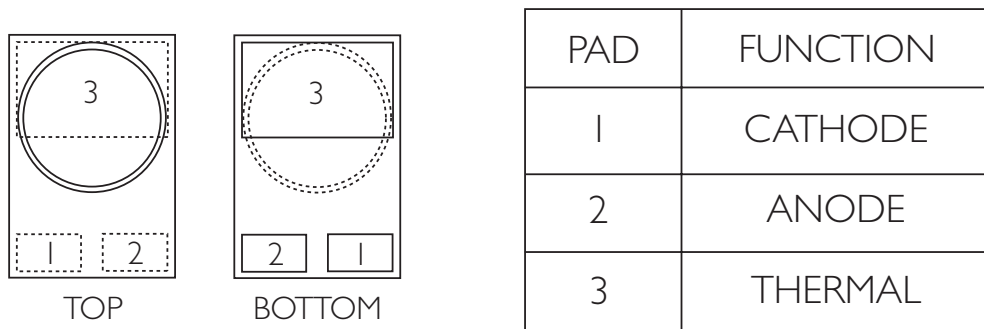

Figure 3. Pad configuration.

Note for Figure 3:

1. The Thermal Pad is electrically isolated from the Anode and Cathode contact pads.

## Solder Pad Design

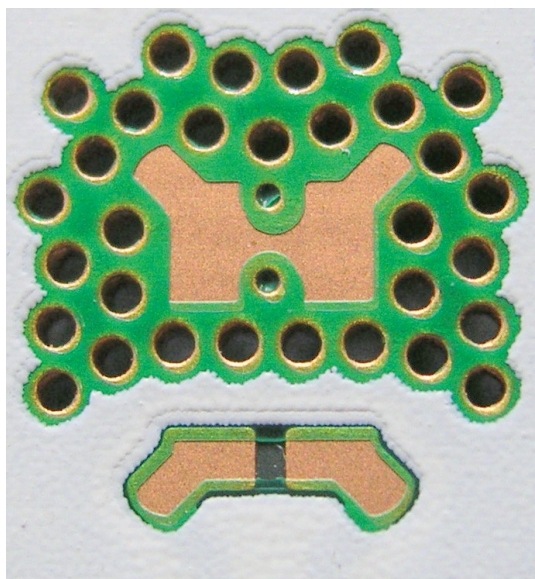

Figure 4. Solder pad layout.

Notes for Figure 4:

1. The photograph shows the recommended LUXEON Rebel PLUS layout on Printed Circuit Board (PCB). This design easily achieves a thermal resistance of 7K/W.
2. Application Brief AB32 provides extensive details for this layout. Printed Circuit Board layout files (.dmg) are available at [www.lumileds.com](http://www.lumileds.com).



# Typical Light Output Characteristics over Temperature

All LUXEON Rebel PLUS Emitters at Test Current, 350mA

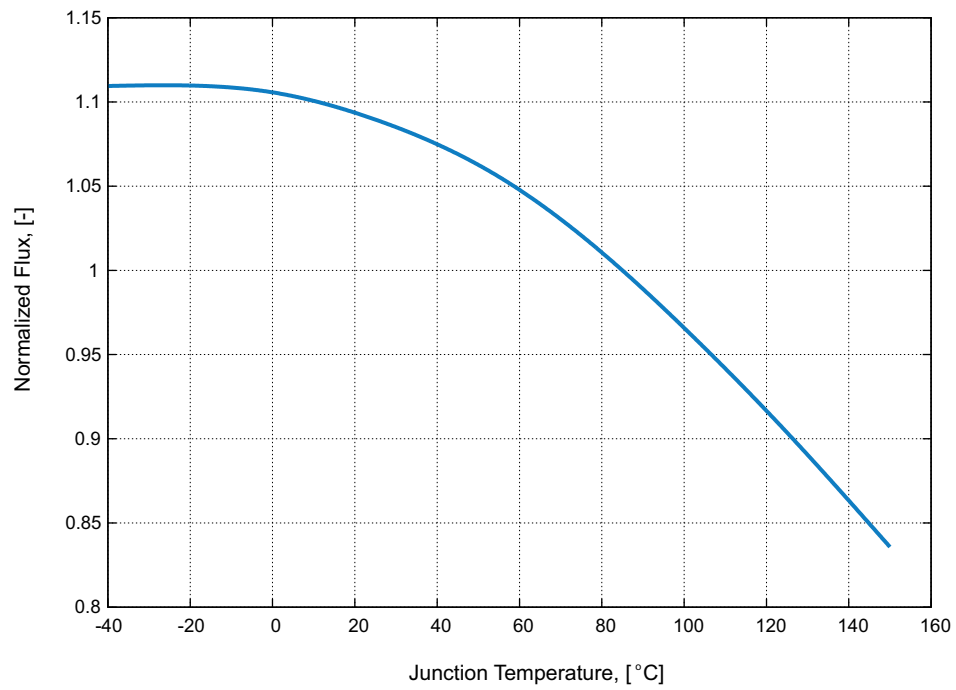

Figure 5. Relative light output vs. junction temperature.

# Typical Forward Current Characteristics

All LUXEON Rebel PLUS Emitters, Junction Temperature = 85°C

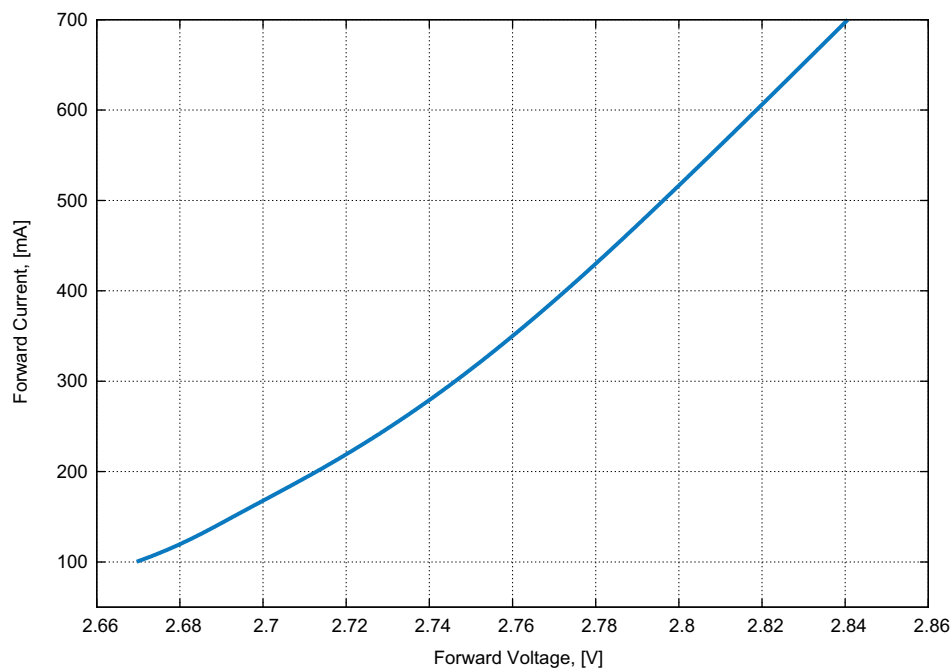

Figure 6. Forward current vs. forward voltage.

Typical Relative Luminous Flux vs. Forward Current for All LUXEON Rebel PLUS Emitters, Junction Temperature = 85°C

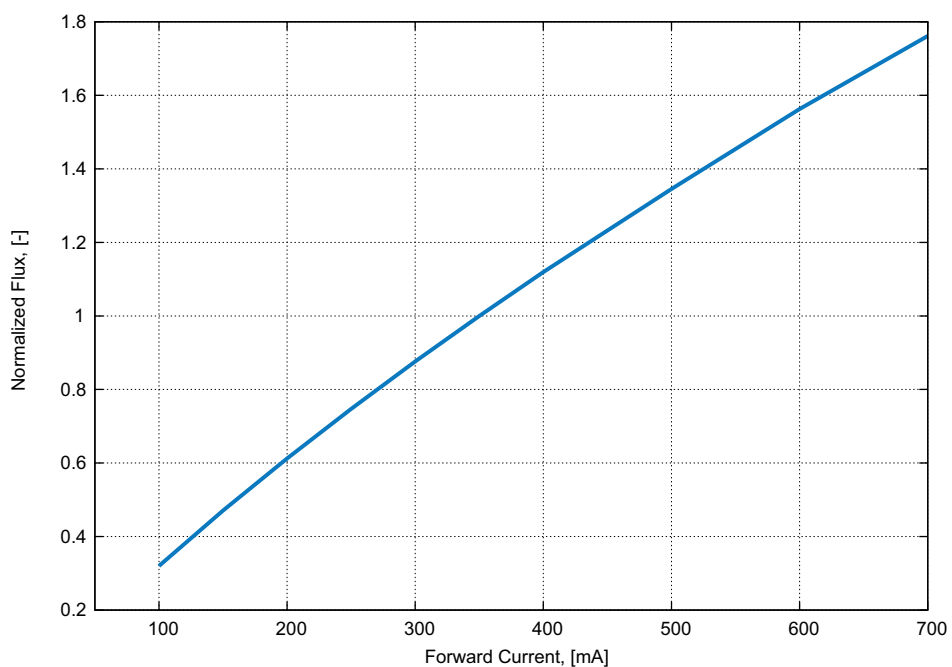

Figure 7. Typical relative luminous flux vs. forward current, junction temperature = 85°C.

# Typical Radiation Patterns

## Relative Spectral Distribution for LUXEON Rebel PLUS Emitters

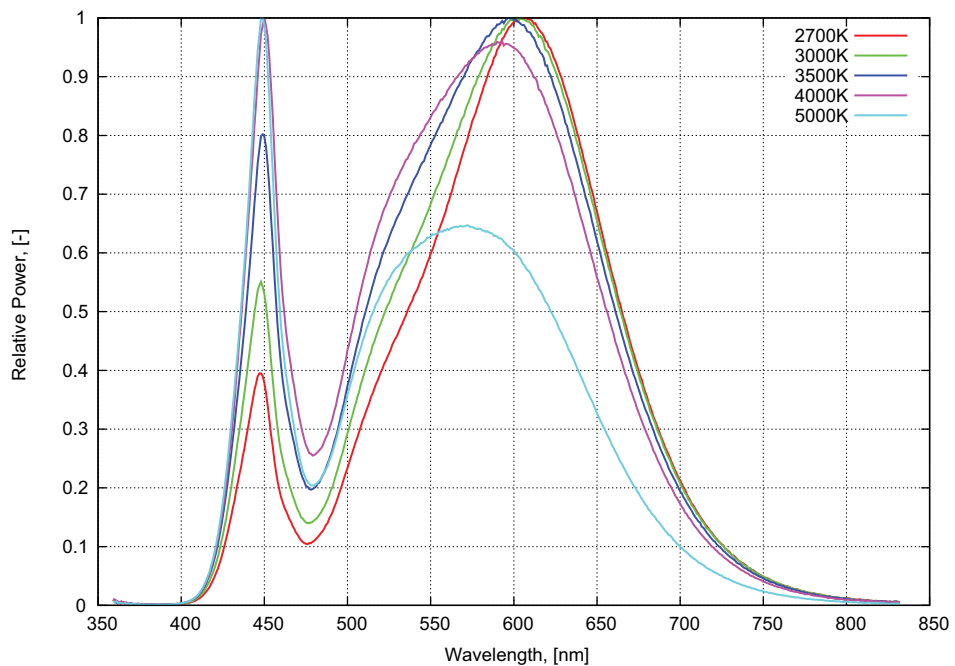

Figure 8. Cartesian plot of typical luminous intensity.

## Typical Polar Radiation Pattern

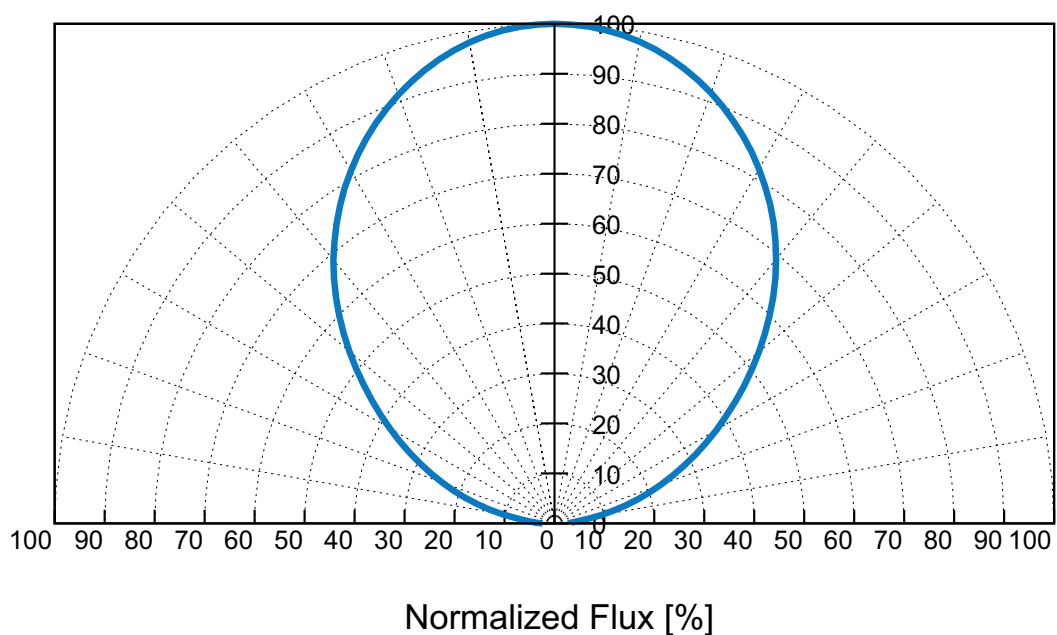

Figure 9. Typical polar radiation pattern.

# Emitter Pocket Tape Packaging

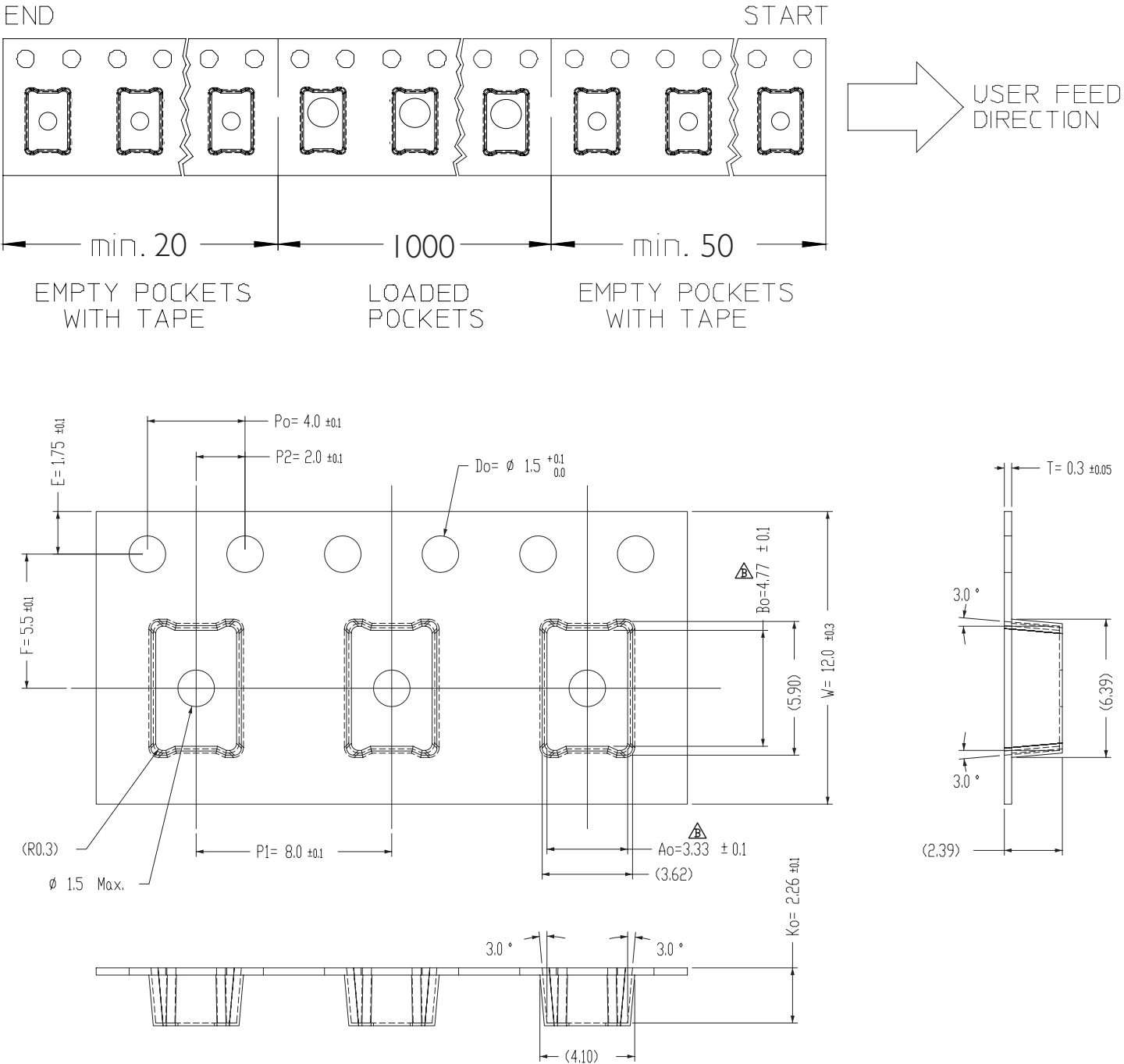

Figure 10. Emitter pocket tape packaging.

# Emitter Reel Packaging

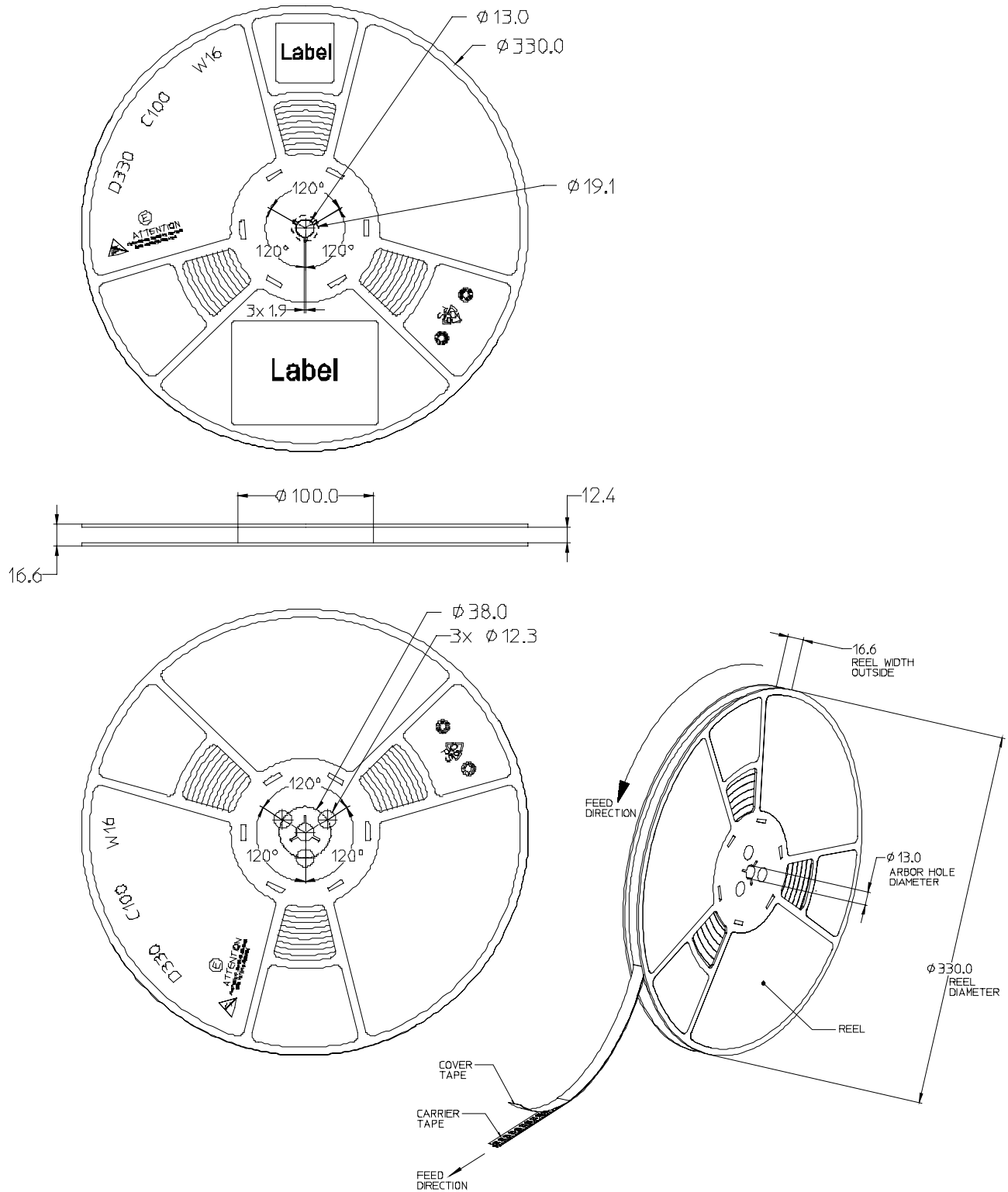

Figure 11. Emitter reel packaging.

# Product Binning and Labeling

## Purpose of Product Binning

In the manufacturing of semiconductor products, there is a variation of performance around the average values given in the technical data sheets. For this reason, Lumileds bins the LED components for luminous flux and forward voltage ( $V_f$ ). Color is offered in a single 3-step or 5-step MacAdam ellipse color space centered on the ANSI CCT color bins. For additional information please review the MacAdam ellipse technical definition section.

## Decoding Product Bin Labeling

LUXEON Rebel PLUS emitters are labeled using a four digit alphanumeric code (CAT code) depicting the bin values for emitters packaged on a single reel. All emitters packaged within a reel are of the same 3-variable bin combination. Using these codes, it is possible to determine optimum mixing and matching of products for consistency in a given application.

Reels of LUXEON Rebel PLUS emitters are labeled with a three digit alphanumeric CAT code following the format below.

A B C D

A = Flux bins (A, B, C, D, E, F,G)

B and C = Color Bins (13, 1A, 1B, 1C, 1D)

D = Voltage Bins (1, 2)

A
Flux Bin
see flux bin table

B	
CRI	
1	80 CRI min

C	
Color Bin	
3	3-step
A	5-step
B	
C	
D	

D		
Vf	min	max
1	2.50V	2.75V
2	2.75V	3.00V

# Luminous Flux and Forward Voltage Bins

Table 7 lists the standard photometric luminous flux bins for LUXEON Rebel PLUS emitters (tested and binned at 350mA D.C., Junction Temperature = 85°C. Minimum luminous flux performance within published operating conditions. Lumileds maintains a tolerance of ±6.5% on luminous flux measurements.

Although several bins are outlined, product availability in a particular bin varies by production run and by product performance.

Not all bins are available in all CCT's.

**Table 7. Luminous Flux Bins**

Bin Code	Minimum Photometric Flux (lm)	Maximum Photometric Flux (lm)
A <sup>[2]</sup>	75	85
B	85	95
C	95	105
D	105	115
E	115	125
F	125	135

Notes for Table 7:

1. Minimum luminous flux performance within published operating conditions. Lumileds maintains a tolerance of ±6.5% on luminous flux measurements.
2. For LX18-P127 minimum flux is 80 lm.
  - A is the cat code for 80-85 lm for the above emitters.
3. For LX18-P135 and LX18-P140 minimum flux is 90 lm.
  - B is the cat code for 90-95 lm for the above emitters.

Table 8 lists minimum and maximum  $V_f$  bin values per emitter (tested and binned at 350mA). Although several bins are outlined, product availability in a particular bin varies by production run and by product performance.

**Table 8.  $V_f$  Bins**

Bin Code	Minimum Forward Voltage (V)	Maximum Forward Voltage (V)
1	2.50	2.75
2	2.75	3.00

# LUXEON Rebel PLUS 3-step and 5-step MacAdam Ellipse Color Definition

Tested at 350mA D.C. & Junction Temperature = 85°C

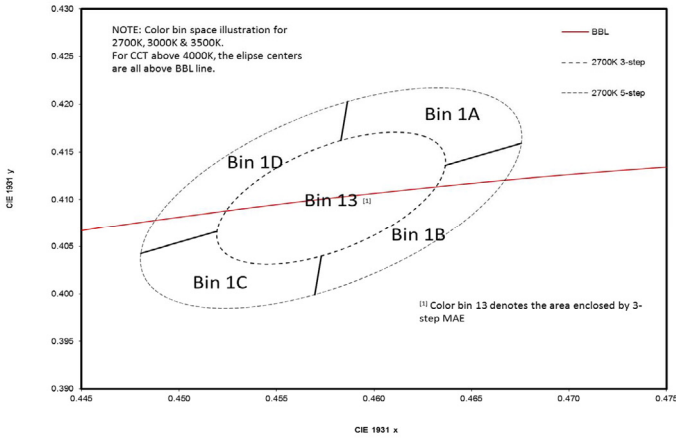

Color Space Definition for Above and Below Blackbody

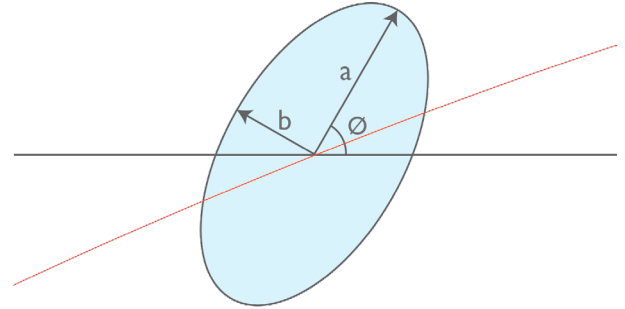

Parameter Definition of MacAdam Ellipse

Table 9. LUXEON Rebel PLUS Product Characteristics for 3-step MacAdam Ellipse

Part Number	Nominal ANSI CCT	Color Space	Center Point (cx, cy)	Major Axis, a	Minor Axis, b	Ellipse Rotation Angle (degrees)
LX18-P127-3	2700K	Single 3-step MacAdam ellipse	(0.4578, 0.4101)	0.00810	0.00420	53.7
LX18-P130-3	3000K	Single 3-step MacAdam ellipse	(0.4338, 0.4030)	0.00834	0.00408	53.2
LX18-P135-3	3500K	Single 3-step MacAdam ellipse	(0.4073, 0.3917)	0.00927	0.00414	54.0
LX18-P140-3	4000K	Single 3-step MacAdam ellipse	(0.3818, 0.3797)	0.00939	0.00402	53.7
LX18-P150-3	5000K	Single 3-step MacAdam ellipse	(0.3447, 0.3553)	0.00822	0.00354	59.6

Table 10. LUXEON Rebel PLUS Product Characteristics for 5-step MacAdam Ellipse

Part Number	Nominal ANSI CCT	Color Space	Center Point (cx, cy)	Major Axis, a	Minor Axis, b	Ellipse Rotation Angle (degrees)
LX18-P127-5	2700K	Single 5-step MacAdam ellipse	(0.4578, 0.4101)	0.01350	0.00700	53.7
LX18-P130-5	3000K	Single 5-step MacAdam ellipse	(0.4338, 0.4030)	0.01390	0.00680	53.2
LX18-P135-5	3500K	Single 5-step MacAdam ellipse	(0.4073, 0.3917)	0.01545	0.00690	54.0
LX18-P140-5	4000K	Single 5-step MacAdam ellipse	(0.3818, 0.3797)	0.01565	0.00670	53.7
LX18-P150-5	5000K	Single 5-step MacAdam ellipse	(0.3447, 0.3553)	0.01370	0.00590	59.6

Notes for Tables 9 and 10:

- Lumileds maintains a tester tolerance of  $\pm 0.005$  on x, y color coordinates.



# About Lumileds

Lumileds is the light engine leader, delivering innovation, quality, and reliability.

For 100 years, Lumileds commitment to innovation has helped customers pioneer breakthrough products in the automotive, consumer and illumination markets.

Lumileds is shaping the future of light with our LEDs and automotive lamps, and helping our customers illuminate how people see the world around them.

To learn more about our portfolio of light engines visit [www.lumileds.com](http://www.lumileds.com).



©2015 Lumileds Holding B.V. All rights reserved.  
LUXEON is a registered trademark of the Lumileds Holding B.V.  
in the United States and other countries.

[www.lumileds.com](http://www.lumileds.com)

Neither Lumileds Holding B.V. nor its affiliates shall be liable for any kind of loss of data or any other damages, direct, indirect or consequential, resulting from the use of the provided information and data. Although Lumileds Holding B.V. and/or its affiliates have attempted to provide the most accurate information and data, the materials and services information and data are provided "as is," and neither Lumileds Holding B.V. nor its affiliates warrants or guarantees the contents and correctness of the provided information and data. Lumileds Holding B.V. and its affiliates reserve the right to make changes without notice. You as user agree to this disclaimer and user agreement with the download or use of the provided materials, information and data.



Компания «ЭлектроПласт» предлагает заключение долгосрочных отношений при поставках импортных электронных компонентов на взаимовыгодных условиях!

Наши преимущества:

- Оперативные поставки широкого спектра электронных компонентов отечественного и импортного производства напрямую от производителей и с крупнейших мировых складов;
- Поставка более 17-ти миллионов наименований электронных компонентов;
- Поставка сложных, дефицитных, либо снятых с производства позиций;
- Оперативные сроки поставки под заказ (от 5 рабочих дней);
- Экспресс доставка в любую точку России;
- Техническая поддержка проекта, помощь в подборе аналогов, поставка прототипов;
- Система менеджмента качества сертифицирована по Международному стандарту ISO 9001;
- Лицензия ФСБ на осуществление работ с использованием сведений, составляющих государственную тайну;
- Поставка специализированных компонентов (Xilinx, Altera, Analog Devices, Intersil, Interpoint, Microsemi, Aeroflex, Peregrine, Syfer, Eurofarad, Texas Instrument, Miteq, Cobham, E2V, MA-COM, Hittite, Mini-Circuits, General Dynamics и др.);

Помимо этого, одним из направлений компании «ЭлектроПласт» является направление «Источники питания». Мы предлагаем Вам помощь Конструкторского отдела:

- Подбор оптимального решения, техническое обоснование при выборе компонента;
- Подбор аналогов;
- Консультации по применению компонента;
- Поставка образцов и прототипов;
- Техническая поддержка проекта;
- Защита от снятия компонента с производства.



#### Как с нами связаться

**Телефон:** 8 (812) 309 58 32 (многоканальный)

**Факс:** 8 (812) 320-02-42

**Электронная почта:** [org@eplast1.ru](mailto:org@eplast1.ru)

**Адрес:** 198099, г. Санкт-Петербург, ул. Калинина, дом 2, корпус 4, литера А.