

General Specifications

Electrical Capacity (Resistive Load)

Power Level (code W): 3A @ 125V AC

Logic Level (code G): 0.4VA maximum @ 28V AC/DC maximum
(Applicable Range 0.1mA ~ 0.1A @ 20mV ~ 28V)

Logic/Power Level (code A): Combines W & G ratings

Note: See Supplement section to find explanation of operating range.

Other Ratings

Contact Resistance: 20 milliohms maximum for silver; 30 milliohms maximum for gold

Insulation Resistance: 1,000 megohms minimum @ 500V DC

Dielectric Strength: 1,000V AC minimum between contacts for 1 minute minimum;
1,500V AC minimum between contacts & case for 1 minute minimum

Mechanical Life: 200,000 operations minimum

Electrical Life: 25,000 operations minimum for silver; 100,000 operations minimum for gold

Nominal Operating Force: Single pole 2.45N; double pole 3.92N

Travel: Pretravel .024" (0.6mm); Overtravel .016" (0.4mm); Total Travel .039" (1.0mm)

Materials & Finishes

Plunger: Brass with nickel plating

Bushing: Brass with nickel plating

Mounting & Body Frames: Stainless steel

Support Bracket: Brass with tin plating

Case: Glass fiber reinforced polyester (UL94V-0)

Base: Diallyl phthalate resin

Movable Contactor: Phosphor bronze with silver or gold plating

Movable Contacts: Silver alloy (code W); copper with gold plating (code G)

Stationary Contacts: Silver with silver plating (code W); copper or brass with gold plating (code G)

Terminals: Copper with silver plating; copper or brass with gold plating

Environmental Data

Operating Temp Range: -30°C through +85°C (-22°F through +185°F)

Humidity: 90 ~ 95% humidity for 100 hours @ 40°C (104°F)

Vibration: 10 ~ 55Hz with peak-to-peak amplitude of 1.5mm traversing the frequency range & returning in 1 minute; 3 right angled directions for 2 hours

Shock: 50G (490m/s²) acceleration (tested in 6 right angled directions, with 5 shocks in each direction)

Installation

Mounting Torque: 1.5Nm (13 lb•in) for double nut; 0.7Nm (6 lb•in) for single nut

Cap Installation Force: 80N (18 lbf) maximum downward force on actuator

Processing

Soldering: Wave Soldering Recommended: See Profile B in Supplement section.

Manual Soldering: See Profile B in Supplement section.

Cleaning: These devices are not process sealed. Hand clean locally using alcohol based solution.

Standards & Certifications

Flammability Standards: UL94V-0 Case

UL : File No. E44145 - Recognized only when ordered with marking on switch.

Add "/U" or "/CUL" before dash in part number to order UL recognized switch.

All single & double pole models recognized at 3A @ 125V AC or 0.4VA max. @ 28V AC/DC max.

CSA: File No. 023535_0_000 - Certified only when ordered with marking on switch.

Add "/C" before dash in part number to order CSA certified switch.

Single pole & double pole models certified at 3A @ 125V AC or 0.4VA max. @ 28V AC/DC max.

Distinctive Characteristics

Short stroke and light touch.

Antijamming design protects contacts from damage due to excessive downward force on the actuator.

High torque bushing construction prevents rotation or separation from frame during installation.

Stainless steel frame resists corrosion.

Longer center solder lug terminal simplifies wiring and soldering.

Patented silver contacts of specially composed alloy for hardness.

Epoxy sealed terminals prevent entry of solder flux and other contaminants.

Snap-acting mechanism gives smooth actuation and audible feedback.

Prominent external insulating barriers increase insulation resistance and dielectric strength.

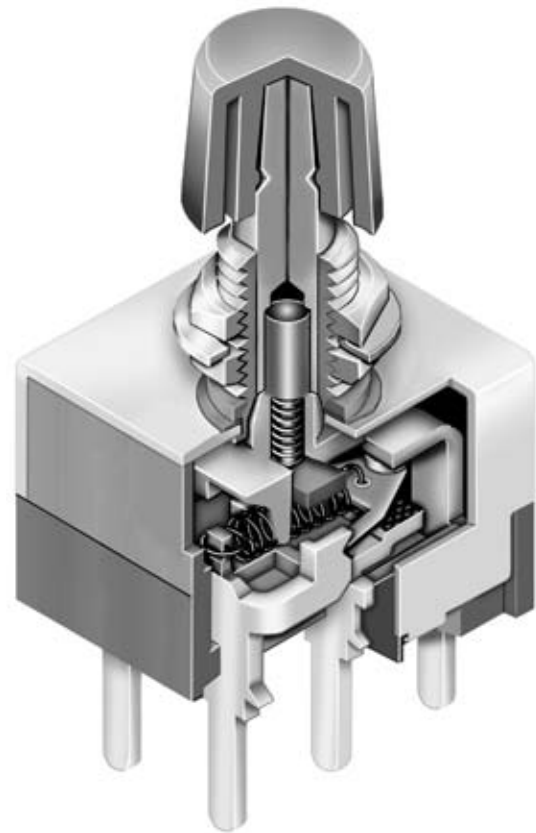

Actual Size

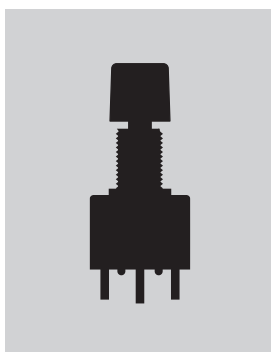

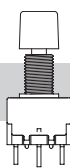
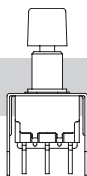
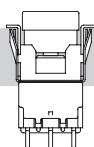
	Bushing Mount	Page C118
	Bracket PC Mount	Page C121
	Snap-in Mount	Page C124

- Toggle
- Rockers
- Pushbuttons**
- Illuminated PB
- Programmable
- Keylocks
- Rotaries
- Slides
- Tactiles
- Tilt
- Touch
- Indicators
- Accessories
- Supplement

TYPICAL SWITCH ORDERING EXAMPLE

MB25

11

S4

W

01

B

C

Poles & Circuits

11	SPDT	ON	(ON)
21	DPDT	ON	(ON)

() = Momentary

Contact Materials & Ratings

W	Silver Rated 3A @ 125V AC
G	Gold Rated 0.4VA max @ 28V AC/DC max

Caps

B	.315" (8.0mm) Diameter
C	.394" (10.0mm) Diameter

Bushing

S4	.315" (8.0mm) Threaded with Keyway
-----------	---------------------------------------

Terminals

01	Solder Lug
03	.250" (6.35mm) Straight PC

Cap Colors

A	Black
B	White
C	Red
E	Yellow
F	Green
G	Blue

IMPORTANT:





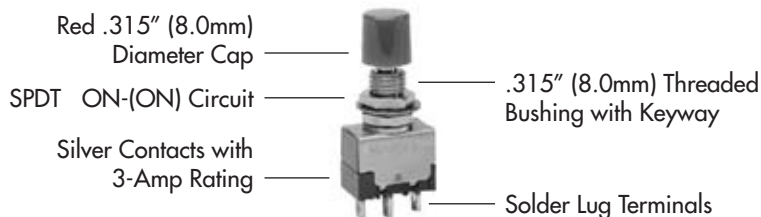

Switches are supplied without UL, cULus & CSA marking unless specified.
UL, cULus & CSA recognized only when ordered with marking on the switch.
 Specific models, ratings, & ordering instructions are noted on the General Specifications page.

DESCRIPTION FOR TYPICAL ORDERING EXAMPLE

MB2511S4W01-BC

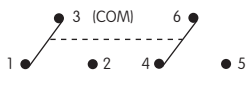

POLES & CIRCUITS

Pole	Model	Plunger Position () = Momentary		Connected Terminals		Throw & Switch Schematics
		Normal  Keyway	Down 	Normal  Keyway	Down 	
SP	MB2511	ON	(ON)	3-1	3-2	SPDT 
DP	MB2521	ON	(ON)	3-1 6-4	3-2 6-5	DPDT 

Note: Terminal numbers are not actually on the switch.

BUSHING

S4 .315" (8.0mm)
Threaded with Keyway

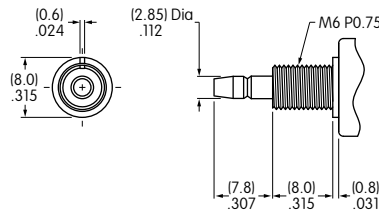

Panel Cutouts

Without Keyway

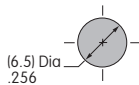

With Keyway

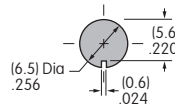

With Optional Locking Ring

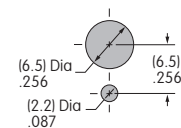

Maximum Panel Thickness with Standard Hardware: .134" (3.4mm)

Standard Hardware

AT513M Threaded Hex Nut

2 included with each switch

Brass with nickel plating

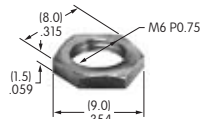

AT509 Lockwasher

1 included with each switch

Steel with zinc/chromate

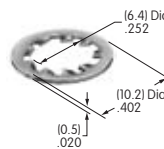

Optional Hardware

AT507M Locking Ring

Steel with zinc/chromate

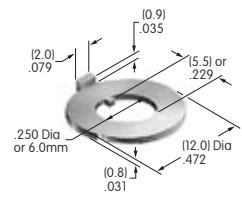

CONTACT MATERIALS & RATINGS

W Silver over Silver

Power Level

3A @ 125V AC

G Gold over Brass or Copper

Logic Level

0.4VA maximum @ 28V AC/DC maximum

Note: Complete explanation of operating range in Supplement section.

Toggles
Rockers
Pushbuttons
Illuminated PB
Programmable
Keylocks
Rotaries
Slides
Tactiles
Tilt
Touch
Indicators
Accessories
Supplement

Toggles

Rockers

Pushbuttons

Programmable Illuminated PB

Keylocks

Rotaries

Slides

Tactiles

Tilt

Touch

Indicators

Accessories

Supplement

TERMINALS

01 Solder Lug

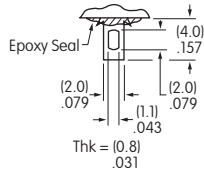

03 .250" (6.35mm) Straight PC

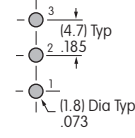
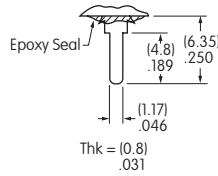

Single Pole

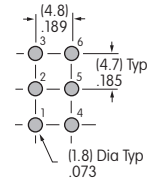

Double Pole

CAPS & CAP COLORS

B AT443
.315" (8.0mm) Diameter Cap

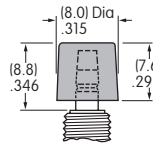

Material: Polycarbonate

Finish: Glossy

C AT442
.394" (10.0mm) Diameter Cap

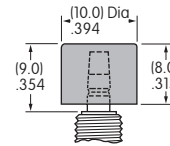

Material: Polycarbonate

Finish: Glossy

Cap Colors Available:

- A** Black
- B** White
- C** Red
- E** Yellow
- F** Green
- G** Blue

TYPICAL SWITCH DIMENSIONS

Solder Lug

Single Pole

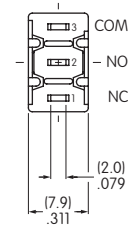
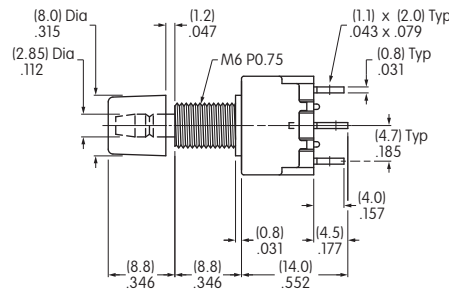
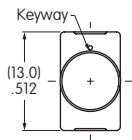

MB2511S4W01-BC

Solder Lug

Double Pole

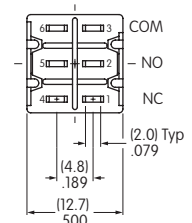
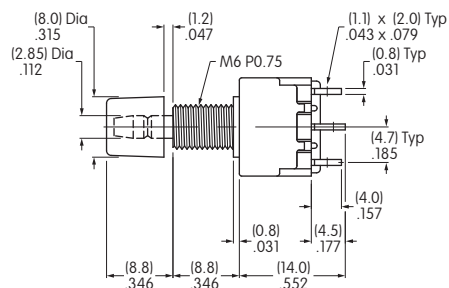
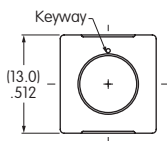

MB2521S4W01-BC



Компания «ЭлектроПласт» предлагает заключение долгосрочных отношений при поставках импортных электронных компонентов на взаимовыгодных условиях!

Наши преимущества:

- Оперативные поставки широкого спектра электронных компонентов отечественного и импортного производства напрямую от производителей и с крупнейших мировых складов;
- Поставка более 17-ти миллионов наименований электронных компонентов;
- Поставка сложных, дефицитных, либо снятых с производства позиций;
- Оперативные сроки поставки под заказ (от 5 рабочих дней);
- Экспресс доставка в любую точку России;
- Техническая поддержка проекта, помощь в подборе аналогов, поставка прототипов;
- Система менеджмента качества сертифицирована по Международному стандарту ISO 9001;
- Лицензия ФСБ на осуществление работ с использованием сведений, составляющих государственную тайну;
- Поставка специализированных компонентов (Xilinx, Altera, Analog Devices, Intersil, Interpoint, Microsemi, Aeroflex, Peregrine, Syfer, Eurofarad, Texas Instrument, Miteq, Cobham, E2V, MA-COM, Hittite, Mini-Circuits, General Dynamics и др.);

Помимо этого, одним из направлений компании «ЭлектроПласт» является направление «Источники питания». Мы предлагаем Вам помощь Конструкторского отдела:

- Подбор оптимального решения, техническое обоснование при выборе компонента;
- Подбор аналогов;
- Консультации по применению компонента;
- Поставка образцов и прототипов;
- Техническая поддержка проекта;
- Защита от снятия компонента с производства.



Как с нами связаться

Телефон: 8 (812) 309 58 32 (многоканальный)

Факс: 8 (812) 320-02-42

Электронная почта: org@eplast1.ru

Адрес: 198099, г. Санкт-Петербург, ул. Калинина, дом 2, корпус 4, литера А.