

# General Specifications

## Electrical Capacity (Resistive Load)

<b>Power Level (code W):</b>	3A @ 125V AC
<b>Logic Level (code G):</b>	0.4VA maximum @ 28V AC/DC maximum (Applicable Range 0.1mA ~ 0.1A @ 20mV ~ 28V)
<b>Logic/Power Level (code A):</b>	Combines W & G ratings Note: See Supplement section to find explanation of operating range.

## Other Ratings

<b>Contact Resistance:</b>	20 milliohms maximum for silver; 30 milliohms maximum for gold
<b>Insulation Resistance:</b>	1,000 megohms minimum @ 500V DC
<b>Dielectric Strength:</b>	1,000V AC minimum between contacts for 1 minute minimum; 1,500V AC minimum between contacts & case for 1 minute minimum
<b>Mechanical Life:</b>	200,000 operations minimum
<b>Electrical Life:</b>	25,000 operations minimum for silver; 100,000 operations minimum for gold
<b>Nominal Operating Force:</b>	Single pole 2.45N; double pole 3.92N
<b>Travel:</b>	Pretravel .024" (0.6mm); Overtravel .016" (0.4mm); Total Travel .039" (1.0mm)

## Materials & Finishes

<b>Plunger:</b>	Brass with nickel plating
<b>Bushing:</b>	Brass with nickel plating
<b>Mounting &amp; Body Frames:</b>	Stainless steel
<b>Support Bracket:</b>	Brass with tin plating
<b>Case:</b>	Glass fiber reinforced polyester (UL94V-0)
<b>Base:</b>	Diallyl phthalate resin
<b>Movable Contactor:</b>	Phosphor bronze with silver or gold plating
<b>Movable Contacts:</b>	Silver alloy (code W); copper with gold plating (code G)
<b>Stationary Contacts:</b>	Silver with silver plating (code W); copper or brass with gold plating (code G)
<b>Terminals:</b>	Copper with silver plating; copper or brass with gold plating

## Environmental Data

<b>Operating Temp Range:</b>	-30°C through +85°C (-22°F through +185°F)
<b>Humidity:</b>	90 ~ 95% humidity for 100 hours @ 40°C (104°F)
<b>Vibration:</b>	10 ~ 55Hz with peak-to-peak amplitude of 1.5mm traversing the frequency range & returning in 1 minute; 3 right angled directions for 2 hours
<b>Shock:</b>	50G (490m/s <sup>2</sup> ) acceleration (tested in 6 right angled directions, with 5 shocks in each direction)

## Installation

<b>Mounting Torque:</b>	1.5Nm (13 lb•in) for double nut; 0.7Nm (6 lb•in) for single nut
<b>Cap Installation Force:</b>	80N (18 lbf) maximum downward force on actuator

## Processing

<b>Soldering:</b>	Wave Soldering Recommended: See Profile B in Supplement section. Manual Soldering: See Profile B in Supplement section.
<b>Cleaning:</b>	These devices are not process sealed. Hand clean locally using alcohol based solution.

## Standards & Certifications

<b>Flammability Standards:</b>	UL94V-0 Case
<b>UL :</b>	<b>File No. E44145 - Recognized only when ordered with marking on switch.</b> Add "/U" or "/CUL" before dash in part number to order UL recognized switch. All single & double pole models recognized at 3A @ 125V AC or 0.4VA max. @ 28V AC/DC max.
<b>CSA:</b>	<b>File No. 023535_0_000 - Certified only when ordered with marking on switch.</b> Add "/C" before dash in part number to order CSA certified switch. Single pole & double pole models certified at 3A @ 125V AC or 0.4VA max. @ 28V AC/DC max.

# Distinctive Characteristics

Short stroke and light touch.

Antijamming design protects contacts from damage due to excessive downward force on the actuator.

High torque bushing construction prevents rotation or separation from frame during installation.

Stainless steel frame resists corrosion.

Longer center solder lug terminal simplifies wiring and soldering.

Patented silver contacts of specially composed alloy for hardness.

Epoxy sealed terminals prevent entry of solder flux and other contaminants.

Snap-acting mechanism gives smooth actuation and audible feedback.

Prominent external insulating barriers increase insulation resistance and dielectric strength.

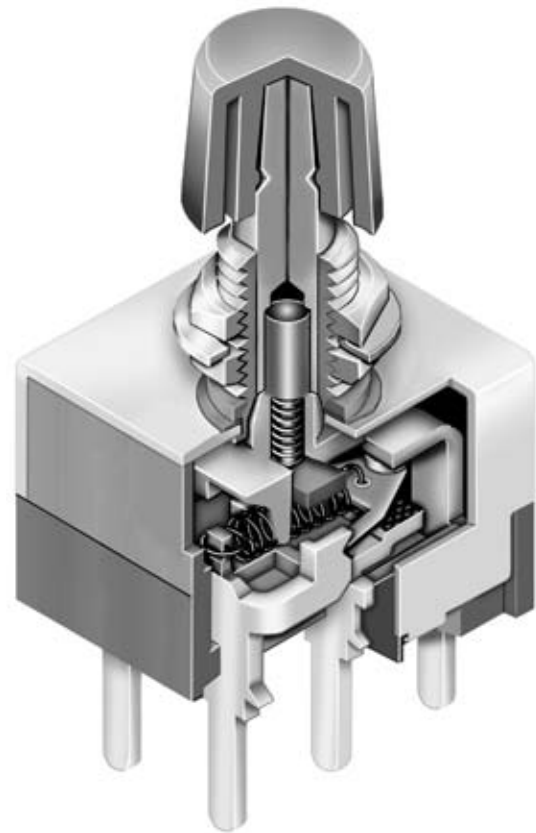

Actual Size

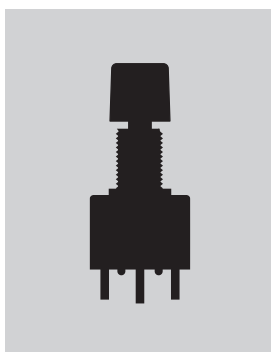

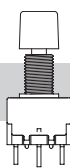
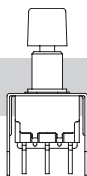
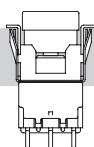
	Bushing Mount	Page C118
	Bracket PC Mount	Page C121
	Snap-in Mount	Page C124

- Toggle
- Rockers
- Pushbuttons**
- Illuminated PB
- Programmable
- Keylocks
- Rotaries
- Slides
- Tactiles
- Tilt
- Touch
- Indicators
- Accessories
- Supplement

### TYPICAL SWITCH ORDERING EXAMPLE

**MB25**

**11**

**S4**

**W**

**01**

**B**

**C**

#### Poles & Circuits

<b>11</b>	SPDT	ON	(ON)
<b>21</b>	DPDT	ON	(ON)

( ) = Momentary

#### Contact Materials & Ratings

<b>W</b>	Silver Rated 3A @ 125V AC
<b>G</b>	Gold Rated 0.4VA max @ 28V AC/DC max

#### Caps

<b>B</b>	.315" (8.0mm) Diameter
<b>C</b>	.394" (10.0mm) Diameter

#### Bushing

<b>S4</b>	.315" (8.0mm) Threaded with Keyway
-----------	---------------------------------------

#### Terminals

<b>01</b>	Solder Lug
<b>03</b>	.250" (6.35mm) Straight PC

#### Cap Colors

<b>A</b>	Black
<b>B</b>	White
<b>C</b>	Red
<b>E</b>	Yellow
<b>F</b>	Green
<b>G</b>	Blue

#### IMPORTANT:





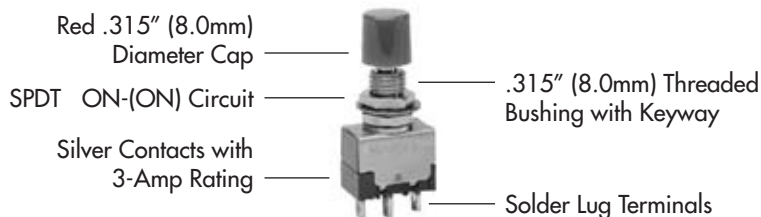

Switches are supplied without UL, cULus & CSA marking unless specified.  
**UL, cULus & CSA recognized only when ordered with marking on the switch.**  
 Specific models, ratings, & ordering instructions are noted on the General Specifications page.

#### DESCRIPTION FOR TYPICAL ORDERING EXAMPLE

**MB2511S4W01-BC**

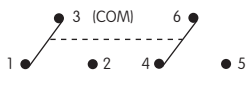

## POLES & CIRCUITS

Pole	Model	Plunger Position ( ) = Momentary		Connected Terminals		Throw & Switch Schematics
		Normal  Keyway	Down 	Normal  Keyway	Down 	
SP	MB2511	ON	(ON)	3-1	3-2	SPDT 
DP	MB2521	ON	(ON)	3-1 6-4	3-2 6-5	DPDT 

Note: Terminal numbers are not actually on the switch.

## BUSHING

**S4** .315" (8.0mm)  
Threaded with Keyway

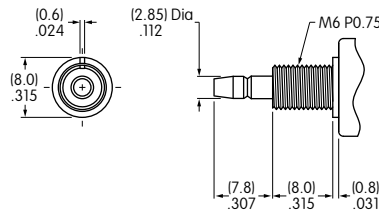

### Panel Cutouts

Without Keyway

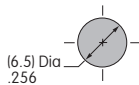

With Keyway

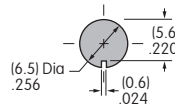

With Optional Locking Ring

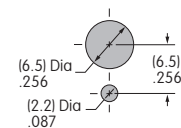

Maximum Panel Thickness with Standard Hardware: .134" (3.4mm)

### Standard Hardware

**AT513M** Threaded  
Hex Nut

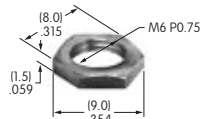

2 included  
with each switch

Brass with  
nickel plating

**AT509**  
Lockwasher

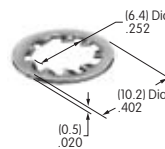

1 included  
with each switch

Steel with  
zinc/chromate

### Optional Hardware

**AT507M**  
Locking Ring

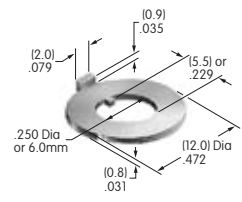

Steel with  
zinc/chromate

## CONTACT MATERIALS & RATINGS

**W** Silver over Silver

Power Level

3A @ 125V AC

**G** Gold over Brass or Copper

Logic Level

0.4VA maximum @ 28V AC/DC maximum

Note: Complete explanation of operating range in Supplement section.

Toggles  
Rockers  
Pushbuttons  
Illuminated PB  
Programmable  
Keylocks  
Rotaries  
Slides  
Tactiles  
Tilt  
Touch  
Indicators  
Accessories  
Supplement

Toggle

Rockers

Pushbuttons

Programmable Illuminated PB

Keylocks

Rotaries

Slides

Tactiles

Tilt

Touch

Indicators

Accessories

Supplement

## TERMINALS

**01** Solder Lug

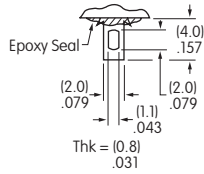

**03** .250" (6.35mm) Straight PC

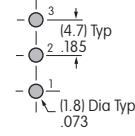
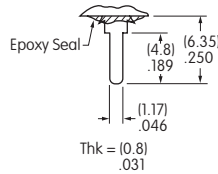

Single Pole

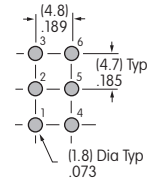

Double Pole

## CAPS & CAP COLORS

**B** AT443  
.315" (8.0mm) Diameter Cap

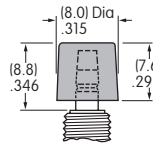

Material: Polycarbonate

Finish: Glossy

**C** AT442  
.394" (10.0mm) Diameter Cap

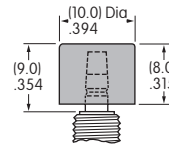

Material: Polycarbonate

Finish: Glossy

Cap Colors Available:

- A** Black
- B** White
- C** Red
- E** Yellow
- F** Green
- G** Blue

## TYPICAL SWITCH DIMENSIONS

Solder Lug

Single Pole

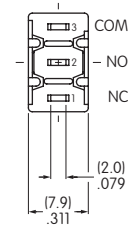
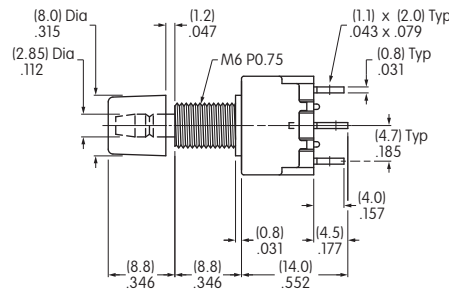
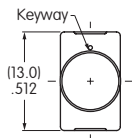

**MB2511S4W01-BC**

Solder Lug

Double Pole

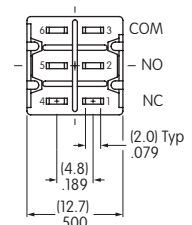
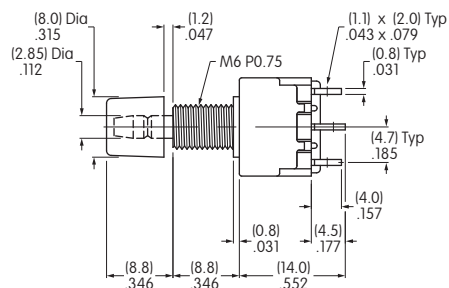
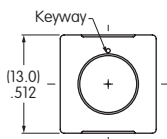

**MB2521S4W01-BC**



Компания «ЭлектроПласт» предлагает заключение долгосрочных отношений при поставках импортных электронных компонентов на взаимовыгодных условиях!

Наши преимущества:

- Оперативные поставки широкого спектра электронных компонентов отечественного и импортного производства напрямую от производителей и с крупнейших мировых складов;
- Поставка более 17-ти миллионов наименований электронных компонентов;
- Поставка сложных, дефицитных, либо снятых с производства позиций;
- Оперативные сроки поставки под заказ (от 5 рабочих дней);
- Экспресс доставка в любую точку России;
- Техническая поддержка проекта, помощь в подборе аналогов, поставка прототипов;
- Система менеджмента качества сертифицирована по Международному стандарту ISO 9001;
- Лицензия ФСБ на осуществление работ с использованием сведений, составляющих государственную тайну;
- Поставка специализированных компонентов (Xilinx, Altera, Analog Devices, Intersil, Interpoint, Microsemi, Aeroflex, Peregrine, Syfer, Eurofarad, Texas Instrument, Miteq, Cobham, E2V, MA-COM, Hittite, Mini-Circuits, General Dynamics и др.);

Помимо этого, одним из направлений компании «ЭлектроПласт» является направление «Источники питания». Мы предлагаем Вам помощь Конструкторского отдела:

- Подбор оптимального решения, техническое обоснование при выборе компонента;
- Подбор аналогов;
- Консультации по применению компонента;
- Поставка образцов и прототипов;
- Техническая поддержка проекта;
- Защита от снятия компонента с производства.



#### Как с нами связаться

**Телефон:** 8 (812) 309 58 32 (многоканальный)

**Факс:** 8 (812) 320-02-42

**Электронная почта:** [org@eplast1.ru](mailto:org@eplast1.ru)

**Адрес:** 198099, г. Санкт-Петербург, ул. Калинина, дом 2, корпус 4, литера А.