



ispMACH™ 4A CPLD Family

High Performance E²CMOS® In-System Programmable Logic



FEATURES

- ◆ **High-performance, E²CMOS 3.3-V & 5-V CPLD families**
- ◆ **Flexible architecture for rapid logic designs**
 - Excellent First-Time-Fit™ and refit feature
 - SpeedLocking™ performance for guaranteed fixed timing
 - Central, input and output switch matrices for 100% routability and 100% pin-out retention
- ◆ **High speed**
 - 5.0ns t_{PD} Commercial and 7.5ns t_{PD} Industrial
 - 182MHz f_{CNT}
- ◆ **32 to 512 macrocells; 32 to 768 registers**
- ◆ **44 to 388 pins in PLCC, PQFP, TQFP, BGA, fpBGA and caBGA packages**
- ◆ **Flexible architecture for a wide range of design styles**
 - D/T registers and latches
 - Synchronous or asynchronous mode
 - Dedicated input registers
 - Programmable polarity
 - Reset/ preset swapping
- ◆ **Advanced capabilities for easy system integration**
 - 3.3-V & 5-V JEDEC-compliant operations
 - JTAG (IEEE 1149.1) compliant for boundary scan testing
 - 3.3-V & 5-V JTAG in-system programming
 - PCI compliant (-5/-55/-6/-65/-7/-10/-12 speed grades)
 - Safe for mixed supply voltage system designs
 - Programmable pull-up or Bus-Friendly™ inputs and I/Os
 - Hot-socketing
 - Programmable security bit
 - Individual output slew rate control
- ◆ **Advanced E²CMOS process provides high-performance, cost-effective solutions**
- ◆ **Lead-free package options**

Table 1. ispMACH 4A Device Features

3.3 V Devices								
Feature	M4A3-32	M4A3-64	M4A3-96	M4A3-128	M4A3-192	M4A3-256	M4A3-384	M4A3-512
Macrocells	32	64	96	128	192	256	384	512
User I/O options	32	32/64	48	64	96	128/160/192	160/192	160/192/256
t_{PD} (ns)	5.0	5.5	5.5	5.5	6.0	5.5	6.5	7.5
f_{CNT} (MHz)	182	167	167	167	160	167	154	125
t_{COS} (ns)	4.0	4.0	4.0	4.0	4.5	4.0	4.5	5.5
t_{SS} (ns)	3.0	3.5	3.5	3.5	3.5	3.5	3.5	5.0
Static Power (mA)	20	25/52	40	55	85	110/150	149/155	179
JTAG Compliant	Yes	Yes	Yes	Yes	Yes	Yes	Yes	Yes
PCI Compliant	Yes	Yes	Yes	Yes	Yes	Yes	Yes	Yes

5 V Devices						
Feature	M4A5-32	M4A5-64	M4A5-96	M4A5-128	M4A5-192	M4A5-256
Macrocells	32	64	96	128	192	256
User I/O options	32	32	48	64	96	128
t_{PD} (ns)	5.0	5.5	5.5	5.5	6.0	6.5
f_{CNT} (MHz)	182	167	167	167	160	154
t_{COS} (ns)	4.0	4.0	4.0	4.0	4.5	5.0
t_{SS} (ns)	3.0	3.5	3.5	3.5	3.5	3.5
Static Power (mA)	20	25	40	55	74	110
JTAG Compliant	Yes	Yes	Yes	Yes	Yes	Yes
PCI Compliant	Yes	Yes	Yes	Yes	Yes	Yes

GENERAL DESCRIPTION

The ispMACH™ 4A family from Lattice offers an exceptionally flexible architecture and delivers a superior Complex Programmable Logic Device (CPLD) solution of easy-to-use silicon products and software tools. The overall benefits for users are a guaranteed and predictable CPLD solution, faster time-to-market, greater flexibility and lower cost. The ispMACH 4A devices offer densities ranging from 32 to 512 macrocells with 100% utilization and 100% pin-out retention. The ispMACH 4A families offer 5-V (M4A5-xxx) and 3.3-V (M4A3-xxx) operation.

ispMACH 4A products are 5-V or 3.3-V in-system programmable through the JTAG (IEEE Std. 1149.1) interface. JTAG boundary scan testing also allows product testability on automated test equipment for device connectivity.

All ispMACH 4A family members deliver First-Time-Fit and easy system integration with pin-out retention after any design change and refit. For both 3.3-V and 5-V operation, ispMACH 4A products can deliver guaranteed fixed timing as fast as 5.0 ns t_{PD} and 182 MHz f_{CNT} through the SpeedLocking feature when using up to 20 product terms per output (Table 2).

Table 2. ispMACH 4A Speed Grades

Device	Speed Grade							
	-5	-55	-6	-65	-7	-10	-12	-14
M4A3-32 M4A5-32	C				C, I	C, I	I	
M4A3-64/32 M4A5-64/32		C			C, I	C, I	I	
M4A3-64/64		C			C, I	C, I	I	
M4A3-96 M4A5-96		C			C, I	C, I	I	
M4A3-128 M4A5-128		C			C, I	C, I	I	
M4A3-192 M4A5-192			C		C, I	C, I	I	
M4A3-256/128 M4A5-256/128		C		C	C, I	C, I	I	
M4A3-256/192 M4A3-256/160					C	C, I	I	
M4A3-384				C		C, I	C, I	I
M4A3-512					C	C, I	C, I	I

Note:

1. C = Commercial, I = Industrial

The ispMACH 4A family offers 20 density-I/O combinations in Thin Quad Flat Pack (TQFP), Plastic Quad Flat Pack (PQFP), Plastic Leaded Chip Carrier (PLCC), Ball Grid Array (BGA), fine-pitch BGA (fpBGA), and chip-array BGA (caBGA) packages ranging from 44 to 388 pins (Table 3). It also offers I/O safety features for mixed-voltage designs so that the 3.3-V devices can accept 5-V inputs, and 5-V devices do not overdrive 3.3-V inputs. Additional features include Bus-Friendly inputs and I/Os, a programmable power-down mode for extra power savings and individual output slew rate control for the highest speed transition or for the lowest noise transition.

Table 3. ispMACH 4A Package and I/O Options (Number of I/Os and dedicated inputs in Table)

3.3 V Devices								
Package	M4A3-32	M4A3-64	M4A3-96	M4A3-128	M4A3-192	M4A3-256	M4A3-384	M4A3-512
44-pin PLCC	32+2	32+2						
44-pin TQFP	32+2	32+2						
48-pin TQFP	32+2	32+2						
100-pin TQFP		64+6	48+8	64+6				
100-pin PQFP				64+6				
100-ball caBGA				64+6				
144-pin TQFP					96+16			
144-ball fpBGA					96+16			
208-pin PQFP						128+14, 160	160	160
256-ball fpBGA						128+14, 192	192	192
256-ball BGA						128+14	192	
388-ball fpBGA								256

5 V Devices						
Package	M4A5-32	M4A5-64	M4A5-96	M4A5-128	M4A5-192	M4A5-256
44-pin PLCC	32+2	32+2				
44-pin TQFP	32+2	32+2				
48-pin TQFP	32+2	32+2				
100-pin TQFP			48+8	64+6		
100-pin PQFP				64+6		
144-pin TQFP					96+16	
208-pin PQFP						128+14

FUNCTIONAL DESCRIPTION

The fundamental architecture of ispMACH 4A devices (Figure 1) consists of multiple, optimized PAL[®] blocks interconnected by a central switch matrix. The central switch matrix allows communication between PAL blocks and routes inputs to the PAL blocks. Together, the PAL blocks and central switch matrix allow the logic designer to create large designs in a single device instead of having to use multiple devices.

The key to being able to make effective use of these devices lies in the interconnect schemes. In the ispMACH 4A architecture, the macrocells are flexibly coupled to the product terms through the logic allocator, and the I/O pins are flexibly coupled to the macrocells due to the output switch matrix. In addition, more input routing options are provided by the input switch matrix. These resources provide the flexibility needed to fit designs efficiently.



17466G-001

Figure 1. ispMACH 4A Block Diagram and PAL Block Structure

Notes:

1. 16 for ispMACH 4A devices with 1:1 macrocell-I/O cell ratio (see next page).
2. Block clocks do not go to I/O cells in M4A(3,5)-32/32.
3. M4A(3,5)-192, M4A(3,5)-256, M4A3-384, and M4A3-512 have dedicated clock pins which cannot be used as inputs and do not connect to the central switch matrix.

Table 4. Architectural Summary of ispMACH 4A devices

	ispMACH 4A Devices	
		M4A3-64/32, M4A5-64/32 M4A3-96/48, M4A5-96/48 M4A3-128/64, M4A5-128/64 M4A3-192/96, M4A5-192/96 M4A3-256/128, M4A5-256/128 M4A3-384 M4A3-512
Macrocell-I/O Cell Ratio	2:1	1:1
Input Switch Matrix	Yes	Yes ¹
Input Registers	Yes	No
Central Switch Matrix	Yes	Yes
Output Switch Matrix	Yes	Yes

The Macrocell-I/O cell ratio is defined as the number of macrocells versus the number of I/O cells internally in a PAL block (Table 4).

The central switch matrix takes all dedicated inputs and signals from the input switch matrices and routes them as needed to the PAL blocks. Feedback signals that return to the same PAL block still must go through the central switch matrix. This mechanism ensures that PAL blocks in ispMACH 4A devices communicate with each other with consistent, predictable delays.

The central switch matrix makes a ispMACH 4A device more advanced than simply several PAL devices on a single chip. It allows the designer to think of the device not as a collection of blocks, but as a single programmable device; the software partitions the design into PAL blocks through the central switch matrix so that the designer does not have to be concerned with the internal architecture of the device.

Each PAL block consists of:

- ◆ Product-term array
- ◆ Logic allocator
- ◆ Macrocells
- ◆ Output switch matrix
- ◆ I/O cells
- ◆ Input switch matrix
- ◆ Clock generator

Notes:

1. M4A3-64/64 internal switch matrix functionality embedded in central switch matrix.

Product-Term Array

The product-term array consists of a number of product terms that form the basis of the logic being implemented. The inputs to the AND gates come from the central switch matrix (Table 5), and are provided in both true and complement forms for efficient logic implementation.

Table 5. PAL Block Inputs

Device	Number of Inputs to PAL Block
M4A3-32/32 and M4A5-32/32	33
M4A3-64/32 and M4A5-64/32	33
M4A3-64/64	33
M4A3-96/48 and M4A5-96/48	33
M4A3-128/64 and M4A5-128/64	33
M4A3-192/96 and M4A5-192/96	34
M4A3-256/128 and M4A5-256/128	34
M4A3-256/160 and M4A3-256/192	36
M4A3-384	36
M4A3-512	36

Logic Allocator

Within the logic allocator, product terms are allocated to macrocells in “product term clusters.” The availability and distribution of product term clusters are automatically considered by the software as it fits functions within a PAL block. The size of a product term cluster has been optimized to provide high utilization of product terms, making complex functions using many product terms possible. Yet when few product terms are used, there will be a minimal number of unused—or wasted—product terms left over. The product term clusters available to each macrocell within a PAL block are shown in Tables 6 and 7.

Each product term cluster is associated with a macrocell. The size of a cluster depends on the configuration of the associated macrocell. When the macrocell is used in synchronous mode (Figure 2a), the basic cluster has 4 product terms. When the associated macrocell is used in asynchronous mode (Figure 2b), the cluster has 2 product terms. Note that if the product term cluster is routed to a different macrocell, the allocator configuration is not determined by the mode of the macrocell actually being driven. The configuration is always set by the mode of the macrocell that the cluster will drive if not routed away, regardless of the actual routing.

In addition, there is an extra product term that can either join the basic cluster to give an extended cluster, or drive the second input of an exclusive-OR gate in the signal path. If included with the basic cluster, this provides for up to 20 product terms on a synchronous function that uses four extended 5-product-term clusters. A similar asynchronous function can have up to 18 product terms.

When the extra product term is used to extend the cluster, the value of the second XOR input can be programmed as a 0 or a 1, giving polarity control. The possible configurations of the logic allocator are shown in Figures 3 and 4.

Table 6. Logic Allocator for All ispMACH 4A Devices (except M4A(3,5)-32/32)

Output Macrocell	Available Clusters	Output Macrocell	Available Clusters
M ₀	C ₀ , C ₁ , C ₂	M ₈	C ₇ , C ₈ , C ₉ , C ₁₀
M ₁	C ₀ , C ₁ , C ₂ , C ₃	M ₉	C ₈ , C ₉ , C ₁₀ , C ₁₁
M ₂	C ₁ , C ₂ , C ₃ , C ₄	M ₁₀	C ₉ , C ₁₀ , C ₁₁ , C ₁₂
M ₃	C ₂ , C ₃ , C ₄ , C ₅	M ₁₁	C ₁₀ , C ₁₁ , C ₁₂ , C ₁₃
M ₄	C ₃ , C ₄ , C ₅ , C ₆	M ₁₂	C ₁₁ , C ₁₂ , C ₁₃ , C ₁₄
M ₅	C ₄ , C ₅ , C ₆ , C ₇	M ₁₃	C ₁₂ , C ₁₃ , C ₁₄ , C ₁₅
M ₆	C ₅ , C ₆ , C ₇ , C ₈	M ₁₄	C ₁₃ , C ₁₄ , C ₁₅
M ₇	C ₆ , C ₇ , C ₈ , C ₉	M ₁₅	C ₁₄ , C ₁₅

Table 7. Logic Allocator for M4A(3,5)-32/32

Output Macrocell	Available Clusters	Output Macrocell	Available Clusters
M ₀	C ₀ , C ₁ , C ₂	M ₈	C ₈ , C ₉ , C ₁₀
M ₁	C ₀ , C ₁ , C ₂ , C ₃	M ₉	C ₈ , C ₉ , C ₁₀ , C ₁₁
M ₂	C ₁ , C ₂ , C ₃ , C ₄	M ₁₀	C ₉ , C ₁₀ , C ₁₁ , C ₁₂
M ₃	C ₂ , C ₃ , C ₄ , C ₅	M ₁₁	C ₁₀ , C ₁₁ , C ₁₂ , C ₁₃
M ₄	C ₃ , C ₄ , C ₅ , C ₆	M ₁₂	C ₁₁ , C ₁₂ , C ₁₃ , C ₁₄
M ₅	C ₄ , C ₅ , C ₆ , C ₇	M ₁₃	C ₁₂ , C ₁₃ , C ₁₄ , C ₁₅
M ₆	C ₅ , C ₆ , C ₇	M ₁₄	C ₁₃ , C ₁₄ , C ₁₅
M ₇	C ₆ , C ₇	M ₁₅	C ₁₄ , C ₁₅



a. Synchronous Mode

17466G-005



b. Asynchronous Mode

17466G-006

Figure 2. Logic Allocator: Configuration of Cluster “n” Set by Mode of Macrocell “n”



17466G-007

Figure 3. Logic Allocator Configurations: Synchronous Mode



17466G-008

Figure 4. Logic Allocator Configurations: Asynchronous Mode

Note that the configuration of the logic allocator has absolutely no impact on the speed of the signal. All configurations have the same delay. This means that designers do not have to decide between optimizing resources or speed; both can be optimized.

If not used in the cluster, the extra product term can act in conjunction with the basic cluster to provide XOR logic for such functions as data comparison, or it can work with the D-,T-type flip-flop to provide for J-K, and S-R register operation. In addition, if the basic cluster is routed to another macrocell, the extra product term is still available for logic. In this case, the first XOR input will be a logic 0. This circuit has the flexibility to route product terms elsewhere without giving up the use of the macrocell.

Product term clusters do not “wrap” around a PAL block. This means that the macrocells at the ends of the block have fewer product terms available.

Macrocell

The macrocell consists of a storage element, routing resources, a clock multiplexer, and initialization control. The macrocell has two fundamental modes: synchronous and asynchronous (Figure 5). The mode chosen only affects clocking and initialization in the macrocell.



a. Synchronous mode



b. Asynchronous mode

17466G-010

Figure 5. Macrocell

In either mode, a combinatorial path can be used. For combinatorial logic, the synchronous mode will generally be used, since it provides more product terms in the allocator.

The flip-flop can be configured as a D-type or T-type latch. J-K or S-R registers can be synthesized. The primary flip-flop configurations are shown in Figure 6, although others are possible. Flip-flop functionality is defined in Table 8. Note that a J-K latch is inadvisable as it will cause oscillation if both J and K inputs are HIGH.



a. D-type with XOR



b. D-type with programmable D polarity



c. Latch with XOR



d. Latch with programmable D polarity

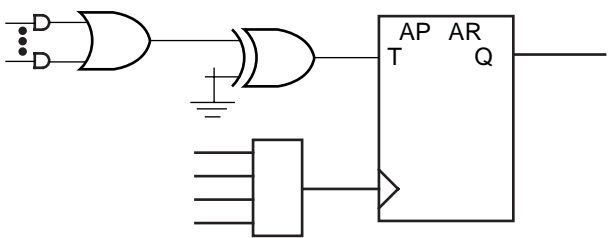

e. T-type with programmable T polarity



f. Combinatorial with XOR



g. Combinatorial with programmable polarity

Figure 6. Primary Macrocell Configurations

17466G-011

Table 8. Register/Latch Operation

Configuration	Input(s)	CLK/LE ¹	Q+
D-type Register	D=X	0, 1, ↓ (↑)	Q
	D=0	↑ (↓)	0
	D=1	↑ (↓)	1
T-type Register	T=X	0, 1, ↓ (↑)	Q
	T=0	↑ (↓)	Q
	T=1	↑ (↓)	\bar{Q}
D-type Latch	D=X	1 (0)	Q
	D=0	0 (1)	0
	D=1	0 (1)	1

Note:

1. Polarity of CLK/LE can be programmed

Although the macrocell shows only one input to the register, the XOR gate in the logic allocator allows the D-, T-type register to emulate J-K, and S-R behavior. In this case, the available product terms are divided between J and K (or S and R). When configured as J-K, S-R, or T-type, the extra product term must be used on the XOR gate input for flip-flop emulation. In any register type, the polarity of the inputs can be programmed.

The clock input to the flip-flop can select any of the four PAL block clocks in synchronous mode, with the additional choice of either polarity of an individual product term clock in the asynchronous mode.

The initialization circuit depends on the mode. In synchronous mode (Figure 7), asynchronous reset and preset are provided, each driven by a product term common to the entire PAL block.



a. Power-up reset

17466G-012



b. Power-up preset

17466G-013

Figure 7. Synchronous Mode Initialization Configurations

A reset/preset swapping feature in each macrocell allows for reset and preset to be exchanged, providing flexibility. In asynchronous mode (Figure 8), a single individual product term is provided for initialization. It can be selected to control reset or preset.



17466G-014

17466G-015

Figure 8. Asynchronous Mode Initialization Configurations

Note that the reset/preset swapping selection feature effects power-up reset as well. The initialization functionality of the flip-flops is illustrated in Table 9. The macrocell sends its data to the output switch matrix and the input switch matrix. The output switch matrix can route this data to an output if so desired. The input switch matrix can send the signal back to the central switch matrix as feedback.

Table 9. Asynchronous Reset/Preset Operation

AR	AP	CLK/LE ¹	Q+
0	0	X	See Table 8
0	1	X	1
1	0	X	0
1	1	X	0

Note:

- Transparent latch is unaffected by AR, AP

Output Switch Matrix

The output switch matrix allows macrocells to be connected to any of several I/O cells within a PAL block. This provides high flexibility in determining pinout and allows design changes to occur without effecting pinout.

In ispMACH 4A devices with 2:1 Macrocell-I/O cell ratio, each PAL block has twice as many macrocells as I/O cells. The ispMACH 4A output switch matrix allows for half of the macrocells to drive I/O cells within a PAL block, in combinations according to Figure 9. Each I/O cell can choose from eight macrocells; each macrocell has a choice of four I/O cells. The ispMACH 4A devices with 1:1 Macrocell-I/O cell ratio allow each macrocell to drive one of eight I/O cells (Figure 9).



Figure 9. ispMACH 4A Output Switch Matrix

Table 10. Output Switch Matrix Combinations for ispMACH 4A Devices with 2:1 Macrocell-I/O Cell Ratio

Macrocell	Routeable to I/O Cells
M0, M1	I/O0, I/O5, I/O6, I/O7
M2, M3	I/O0, I/O1, I/O6, I/O7
M4, M5	I/O0, I/O1, I/O2, I/O7
M6, M7	I/O0, I/O1, I/O2, I/O3
M8, M9	I/O1, I/O2, I/O3, I/O4
M10, M11	I/O2, I/O3, I/O4, I/O5

Table 10. Output Switch Matrix Combinations for ispMACH 4A Devices with 2:1 Macrocell-I/O Cell Ratio

Macrocell	Routable to I/O Cells
M12, M13	I/03, I/04, I/05, I/06
M14, M15	I/04, I/05, I/06, I/07

I/O Cell	Available Macrocells
I/00	M0, M1, M2, M3, M4, M5, M6, M7
I/01	M2, M3, M4, M5, M6, M7, M8, M9
I/02	M4, M5, M6, M7, M8, M9, M10, M11
I/03	M6, M7, M8, M9, M10, M11, M12, M13
I/04	M8, M9, M10, M11, M12, M13, M14, M15
I/05	M0, M1, M10, M11, M12, M13, M14, M15
I/06	M0, M1, M2, M3, M12, M13, M14, M15
I/07	M0, M1, M2, M3, M4, M5, M14, M15

Table 11. Output Switch Matrix Combinations for M4A3-256/160 and M4A3-256/192

Macrocell	Routable to I/O Cells							
M0	I/00	I/01	I/02	I/03	I/04	I/05	I/06	I/07
M1	I/00	I/01	I/02	I/03	I/04	I/05	I/06	I/07
M2	I/00	I/01	I/02	I/03	I/04	I/05	I/06	I/07
M3	I/00	I/01	I/02	I/03	I/04	I/05	I/06	I/07
M4	I/00	I/01	I/02	I/03	I/04	I/05	I/06	I/07
M5	I/00	I/01	I/02	I/03	I/04	I/05	I/06	I/07
M6	I/00	I/01	I/02	I/03	I/04	I/05	I/06	I/07
M7	I/00	I/01	I/02	I/03	I/04	I/05	I/06	I/07
M8	I/08	I/09	I/010	I/011	I/012	I/013	I/014	I/015
M9	I/08	I/09	I/010	I/011	I/012	I/013	I/014	I/015
M10	I/08	I/09	I/010	I/011	I/012	I/013	I/014	I/015
M11	I/08	I/09	I/010	I/011	I/012	I/013	I/014	I/015
M12	I/08	I/09	I/010	I/011	I/012	I/013	I/014	I/015
M13	I/08	I/09	I/010	I/011	I/012	I/013	I/014	I/015
M14	I/08	I/09	I/010	I/011	I/012	I/013	I/014	I/015
M15	I/08	I/09	I/010	I/011	I/012	I/013	I/014	I/015

I/O Cell	Available Macrocells							
I/00	M0	M1	M2	M3	M4	M5	M6	M7
I/01	M0	M1	M2	M3	M4	M5	M6	M7
I/02	M0	M1	M2	M3	M4	M5	M6	M7
I/03	M0	M1	M2	M3	M4	M5	M6	M7
I/04	M0	M1	M2	M3	M4	M5	M6	M7
I/05	M0	M1	M2	M3	M4	M5	M6	M7
I/06	M0	M1	M2	M3	M4	M5	M6	M7
I/07	M0	M1	M2	M3	M4	M5	M6	M7

Table 11. Output Switch Matrix Combinations for M4A3-256/160 and M4A3-256/192

Macrocell	Routable to I/O Cells							
I/O8	M8	M9	M10	M11	M12	M13	M14	M15
I/O9	M8	M9	M10	M11	M12	M13	M14	M15
I/O10	M8	M9	M10	M11	M12	M13	M14	M15
I/O11	M8	M9	M10	M11	M12	M13	M14	M15
I/O12	M8	M9	M10	M11	M12	M13	M14	M15
I/O13	M8	M9	M10	M11	M12	M13	M14	M15
I/O14	M8	M9	M10	M11	M12	M13	M14	M15
I/O15	M8	M9	M10	M11	M12	M13	M14	M15

Table 12. Output Switch Matrix Combinations for M4A(3,5)-32/32

Macrocell	Routable to I/O Cells
M0, M1, M2, M3, M4, M5, M6, M7	I/O0, I/O1, I/O2, I/O3, I/O4, I/O5, I/O6, I/O7
M8, M9, M10, M11, M12, M13, M14, M15	I/O8, I/O9, I/O10, I/O11, I/O12, I/O13, I/O14, I/O15

I/O Cell	Available Macrocells
I/O0, I/O1, I/O2, I/O3, I/O4, I/O5, I/O6, I/O7	M0, M1, M2, M3, M4, M5, M6, M7
I/O8, I/O9, I/O10, I/O11, I/O12, I/O13, I/O14, I/O15	M8, M9, M10, M11, M12, M13, M14, M15

Table 13. Output Switch Matrix Combinations for M4A3-64/64

Macrocell	Routable to I/O Cells
M0, M1	I/O0, I/O1, I/O10, I/O11, I/O12, I/O13, I/O14, I/O15
M2, M3	I/O0, I/O1, I/O2, I/O3, I/O12, I/O13, I/O14, I/O15
M4, M5	I/O0, I/O1, I/O2, I/O3, I/O4, I/O5, I/O14, I/O15
M6, M7	I/O0, I/O1, I/O2, I/O3, I/O4, I/O5, I/O6, I/O7
M8, M9	I/O2, I/O3, I/O4, I/O5, I/O6, I/O7, I/O8, I/O9
M10, M11	I/O4, I/O5, I/O6, I/O7, I/O8, I/O9, I/O10, I/O11
M12, M13	I/O6, I/O7, I/O8, I/O9, I/O10, I/O11, I/O12, I/O13
M14, M15	I/O8, I/O9, I/O10, I/O11, I/O12, I/O13, I/O14, I/O15

I/O Cell	Available Macrocells
I/O0, I/O1	M0, M1, M2, M3, M4, M5, M6, M7
I/O2, I/O3	M2, M3, M4, M5, M6, M7, M8, M9
I/O4, I/O5	M4, M5, M6, M7, M8, M9, M10, M11
I/O6, I/O7	M6, M7, M8, M9, M10, M11, M12, M13
I/O8, I/O9	M8, M9, M10, M11, M12, M13, M14, M15
I/O10, I/O11	M0, M1, M10, M11, M12, M13, M14, M15
I/O12, I/O13	M0, M1, M2, M3, M12, M13, M14, M15
I/O14, I/O15	M0, M1, M2, M3, M4, M5, M14, M15

I/O Cell

The I/O cell (Figures 10 and 11) simply consists of a programmable output enable, a feedback path, and flip-flop (except ispMACH 4A devices with 1:1 macrocell-I/O cell ratio). An individual output enable product term is provided for each I/O cell. The feedback signal drives the input switch matrix.

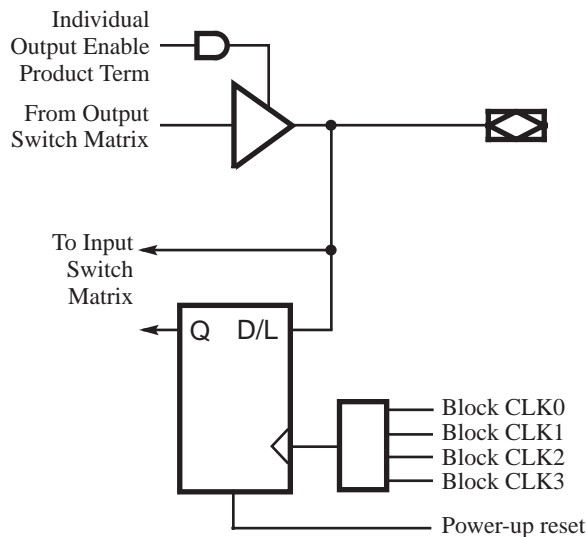

17466G-017

Figure 10. I/O Cell for ispMACH 4A Devices with 2:1 Macrocell-I/O Cell Ratio



17466G-018

Figure 11. I/O Cell for ispMACH 4A Devices with 1:1 Macrocell-I/O Cell Ratio

The I/O cell (Figure 10) contains a flip-flop, which provides the capability for storing the input in a D-type register or latch. The clock can be any of the PAL block clocks. Both the direct and registered versions of the input are sent to the input switch matrix. This allows for such functions as “time-domain-multiplexed” data comparison, where the first data value is stored, and then the second data value is put on the I/O pin and compared with the previous stored value.

Note that the flip-flop used in the ispMACH 4A I/O cell is independent of the flip-flops in the macrocells. It powers up to a logic low.

Zero-Hold-Time Input Register

The ispMACH 4A devices have a zero-hold-time (ZHT) fuse which controls the time delay associated with loading data into all I/O cell registers and latches. When programmed, the ZHT fuse increases the data path setup delays to input storage elements, matching equivalent delays in the clock path. When the fuse is erased, the setup time to the input storage element is minimized. This feature facilitates doing worst-case designs for which data is loaded from sources which have low (or zero) minimum output propagation delays from clock edges.

Input Switch Matrix

The input switch matrix (Figures 12 and 13) optimizes routing of inputs to the central switch matrix. Without the input switch matrix, each input and feedback signal has only one way to enter the central switch matrix. The input switch matrix provides additional ways for these signals to enter the central switch matrix.



17466G-002

Figure 12. ispMACH 4A with 2:1 Macrocell-I/O Cell Ratio - Input Switch Matrix



17466G-003

Figure 13. ispMACH 4A with 1:1 Macrocell-I/O Cell Ratio - Input Switch Matrix

PAL Block Clock Generation

Each ispMACH 4A device has four clock pins that can also be used as inputs. These pins drive a clock generator in each PAL block (Figure 14). The clock generator provides four clock signals that can be used anywhere in the PAL block. These four PAL block clock signals can consist of a large number of combinations of the true and complement edges of the global clock signals. Table 14 lists the possible combinations.



17466G-004

Figure 14. PAL Block Clock Generator¹

1. M4A(3,5)-32/32 and M4A(3,5)-64/32 have only two clock pins, GCLK0 and GCLK1. GCLK2 is tied to GCLK0, and GCLK3 is tied to GCLK1.

Table 14. PAL Block Clock Combinations¹

Block CLK0	Block CLK1	Block CLK2	Block CLK3
GCLK0	GCLK1	X	X
$\overline{\text{GCLK1}}$	GCLK1	X	X
GCLK0	$\overline{\text{GCLK0}}$	X	X
$\overline{\text{GCLK1}}$	$\overline{\text{GCLK0}}$	X	X
X	X	GCLK2 (GCLK0)	GCLK3 (GCLK1)
X	X	$\overline{\text{GCLK3}}$ ($\overline{\text{GCLK1}}$)	GCLK3 (GCLK1)
X	X	GCLK2 (GCLK0)	$\overline{\text{GCLK2}}$ ($\overline{\text{GCLK0}}$)
X	X	$\overline{\text{GCLK3}}$ ($\overline{\text{GCLK1}}$)	$\overline{\text{GCLK2}}$ ($\overline{\text{GCLK0}}$)

Note:

1. Values in parentheses are for the M4A(3,5)-32/32 and M4A(3,5)-64/32.

This feature provides high flexibility for partitioning state machines and dual-phase clocks. It also allows latches to be driven with either polarity of latch enable, and in a master-slave configuration.

ispMACH 4A TIMING MODEL

The primary focus of the ispMACH 4A timing model is to accurately represent the timing in a ispMACH 4A device, and at the same time, be easy to understand. This model accurately describes all combinatorial and registered paths through the device, making a distinction between internal feedback and external feedback. A signal uses internal feedback when it is fed back into the switch matrix or block without having to go through the output buffer. The input register specifications are also reported as internal feedback. When a signal is fed back into the switch matrix after having gone through the output buffer, it is using external feedback.

The parameter, t_{BUF} , is defined as the time it takes to go from feedback through the output buffer to the I/O pad. If a signal goes to the internal feedback rather than to the I/O pad, the parameter designator is followed by an “i”. By adding t_{BUF} to this internal parameter, the external parameter is derived. For example, $t_{PD} = t_{PDi} + t_{BUF}$. A diagram representing the modularized ispMACH 4A timing model is shown in Figure 15. Refer to the application note entitled *MACH 4 Timing and High Speed Design* for a more detailed discussion about the timing parameters.



17466G-025

Figure 15. ispMACH 4A Timing Model

SPEEDLOCKING FOR GUARANTEED FIXED TIMING

The ispMACH 4A architecture allows allocation of up to 20 product terms to an individual macrocell with the assistance of an XOR gate without incurring additional timing delays.

The design of the switch matrix and PAL blocks guarantee a fixed pin-to-pin delay that is independent of the logic required by the design. Other competitive CPLDs incur serious timing delays as product terms expand beyond their typical 4 or 5 product term limits. Speed *and* SpeedLocking combine to give designs easy access to the performance required in today's designs.

IEEE 1149.1-COMPLIANT BOUNDARY SCAN TESTABILITY

All ispMACH 4A devices have boundary scan cells and are compliant to the IEEE 1149.1 standard. This allows functional testing of the circuit board on which the device is mounted through a serial scan path that can access all critical logic nodes. Internal registers are linked internally, allowing test data to be shifted in and loaded directly onto test nodes, or test node data to be captured and shifted out for verification. In addition, these devices can be linked into a board-level serial scan path for more complete board-level testing.

IEEE 1149.1-COMPLIANT IN-SYSTEM PROGRAMMING

Programming devices in-system provides a number of significant benefits including: rapid prototyping, lower inventory levels, higher quality, and the ability to make in-field modifications. All ispMACH 4A devices provide In-System Programming (ISP) capability through their Boundary ScanTest Access Ports. This capability has been implemented in a manner that ensures that the port remains compliant to the IEEE 1149.1 standard. By using IEEE 1149.1 as the communication interface through which ISP is achieved, customers get the benefit of a standard, well-defined interface.

ispMACH 4A devices can be programmed across the commercial temperature and voltage range. The PC-based ispVM™ software facilitates in-system programming of ispMACH 4A devices. ispVM takes the JEDEC file output produced by the design implementation software, along with information about the JTAG chain, and creates a set of vectors that are used to drive the JTAG chain. ispVM software can use these vectors to drive a JTAG chain via the parallel port of a PC. Alternatively, ispVM software can output files in formats understood by common automated test equipment. This equipment can then be used to program ispMACH 4A devices during the testing of a circuit board.

PCI COMPLIANT

ispMACH 4A devices in the -5/-55/-6/-65/-7/-10/-12 speed grades are compliant with the *PCI Local Bus Specification* version 2.1, published by the PCI Special Interest Group (SIG). The 5-V devices are fully PCI-compliant. The 3.3-V devices are mostly compliant but do not meet the PCI condition to clamp the inputs as they rise above V_{CC} because of their 5-V input tolerant feature.

SAFE FOR MIXED SUPPLY VOLTAGE SYSTEM DESIGNS

Both the 3.3-V and 5-V V_{CC} ispMACH 4A devices are safe for mixed supply voltage system designs. The 5-V devices will not overdrive 3.3-V devices above the output voltage of 3.3 V, while they accept inputs from other 3.3-V devices. The 3.3-V device will accept inputs up to 5.5 V. Both the 5-V and 3.3-V versions have the same high-speed performance and provide easy-to-use mixed-voltage design capability.

PULL UP OR BUS-FRIENDLY INPUTS AND I/Os

All ispMACH 4A devices have inputs and I/Os which feature the Bus-Friendly circuitry incorporating two inverters in series which loop back to the input. This double inversion weakly holds the input at its last driven logic state. While it is good design practice to tie unused pins to a known state, the Bus-Friendly input structure pulls pins away from the input threshold voltage where noise can cause high-frequency switching. At power-up, the Bus-Friendly latches are reset to a logic level "1." For the circuit diagram, please refer to the document entitled *MACH Endurance Characteristics* on the Lattice Data Book CD-ROM or Lattice web site.

All ispMACH 4A devices have a programmable bit that configures all inputs and I/Os with either pull-up or Bus-Friendly characteristics. If the device is configured in pull-up mode, all inputs and I/O pins are

weakly pulled up. For the circuit diagram, please refer to the document entitled *MACH Endurance Characteristics* on the Lattice Data Book CD-ROM or Lattice web site.

POWER MANAGEMENT

Each individual PAL block in ispMACH 4A devices features a programmable low-power mode, which results in power savings of up to 50%. The signal speed paths in the low-power PAL block will be slower than those in the non-low-power PAL block. This feature allows speed critical paths to run at maximum frequency while the rest of the signal paths operate in the low-power mode.

PROGRAMMABLE SLEW RATE

Each ispMACH 4A device I/O has an individually programmable output slew rate control bit. Each output can be individually configured for the higher speed transition (3 V/ns) or for the lower noise transition (1 V/ns). For high-speed designs with long, unterminated traces, the slow-slew rate will introduce fewer reflections, less noise, and keep ground bounce to a minimum. For designs with short traces or well terminated lines, the fast slew rate can be used to achieve the highest speed. The slew rate is adjusted independent of power.

POWER-UP RESET/SET

All flip-flops power up to a known state for predictable system initialization. If a macrocell is configured to SET on a signal from the control generator, then that macrocell will be SET during device power-up. If a macrocell is configured to RESET on a signal from the control generator or is not configured for set/reset, then that macrocell will RESET on power-up. To guarantee initialization values, the V_{CC} rise must be monotonic, and the clock must be inactive until the reset delay time has elapsed.

SECURITY BIT

A programmable security bit is provided on the ispMACH 4A devices as a deterrent to unauthorized copying of the array configuration patterns. Once programmed, this bit defeats readback of the programmed pattern by a device programmer, securing proprietary designs from competitors. Programming and verification are also defeated by the security bit. The bit can only be reset by erasing the entire device.

HOT SOCKETING

ispMACH 4A devices are well-suited for those applications that require hot socketing capability. Hot socketing a device requires that the device, when powered down, can tolerate active signals on the I/Os and inputs without being damaged. Additionally, it requires that the effects of the powered-down MACH devices be minimal on active signals.



Figure 16. PAL Block for ispMACH 4A with 2:1 Macrocell - I/O Cell Ratio



17466H-41

Figure 17. PAL Block for ispMACH 4A Devices with 1:1 Macrocell-I/O Cell Ratio (except M4A (3,5)-32/32)



Figure 18. PAL Block for M4A (3,5)-32/32

17466H-042

BLOCK DIAGRAM – M4A(3,5)-32/32



17466H-019

BLOCK DIAGRAM – M4A(3,5)-64/32



17466H-020

BLOCK DIAGRAM – M4A3-64/64



17466H-020A

BLOCK DIAGRAM – M4A(3,5)-96/48



17466G-021

BLOCK DIAGRAM – M4A(3,5)-128/64

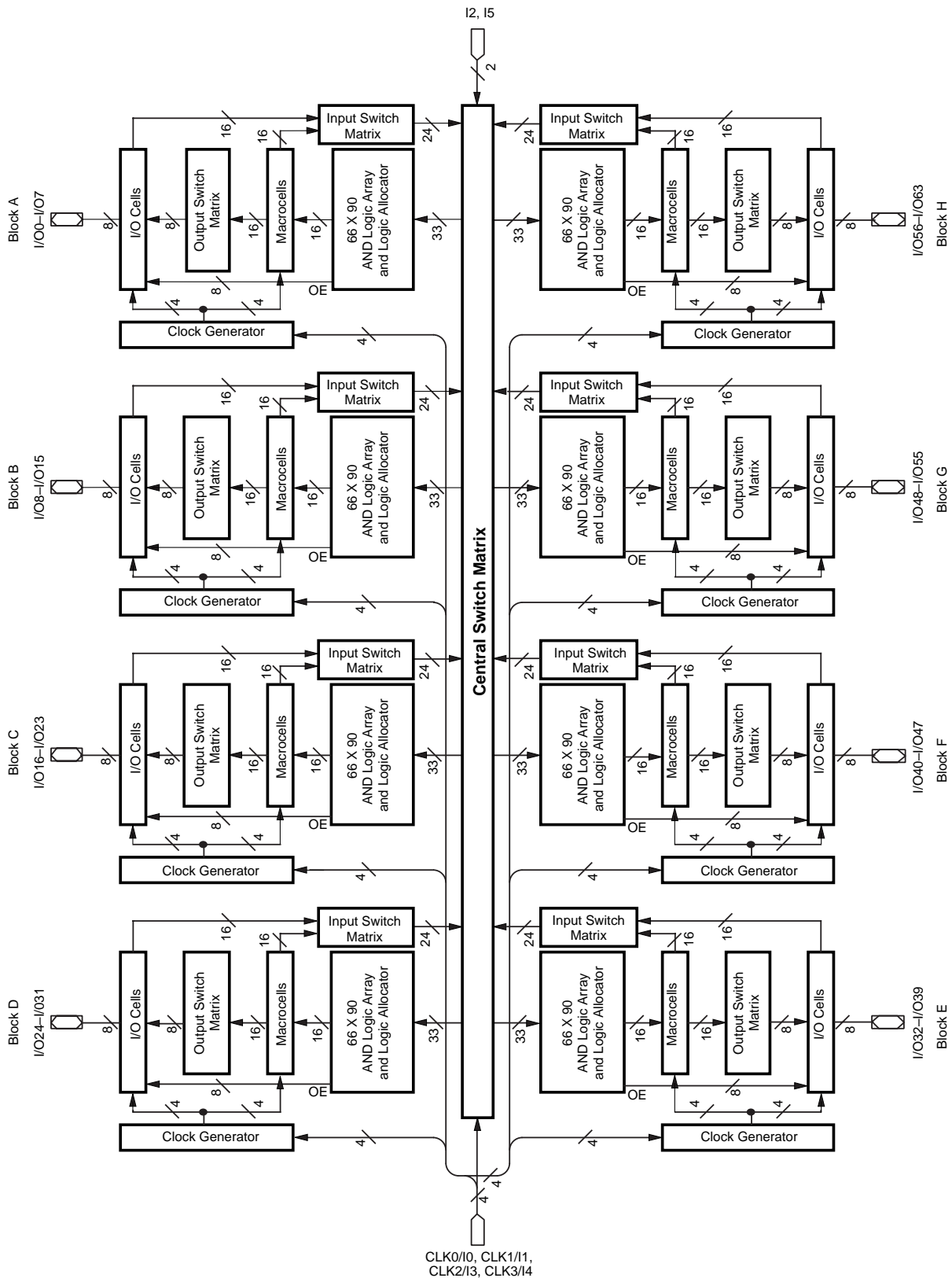

17466H-022

BLOCK DIAGRAM – M4A(3,5)-192/96

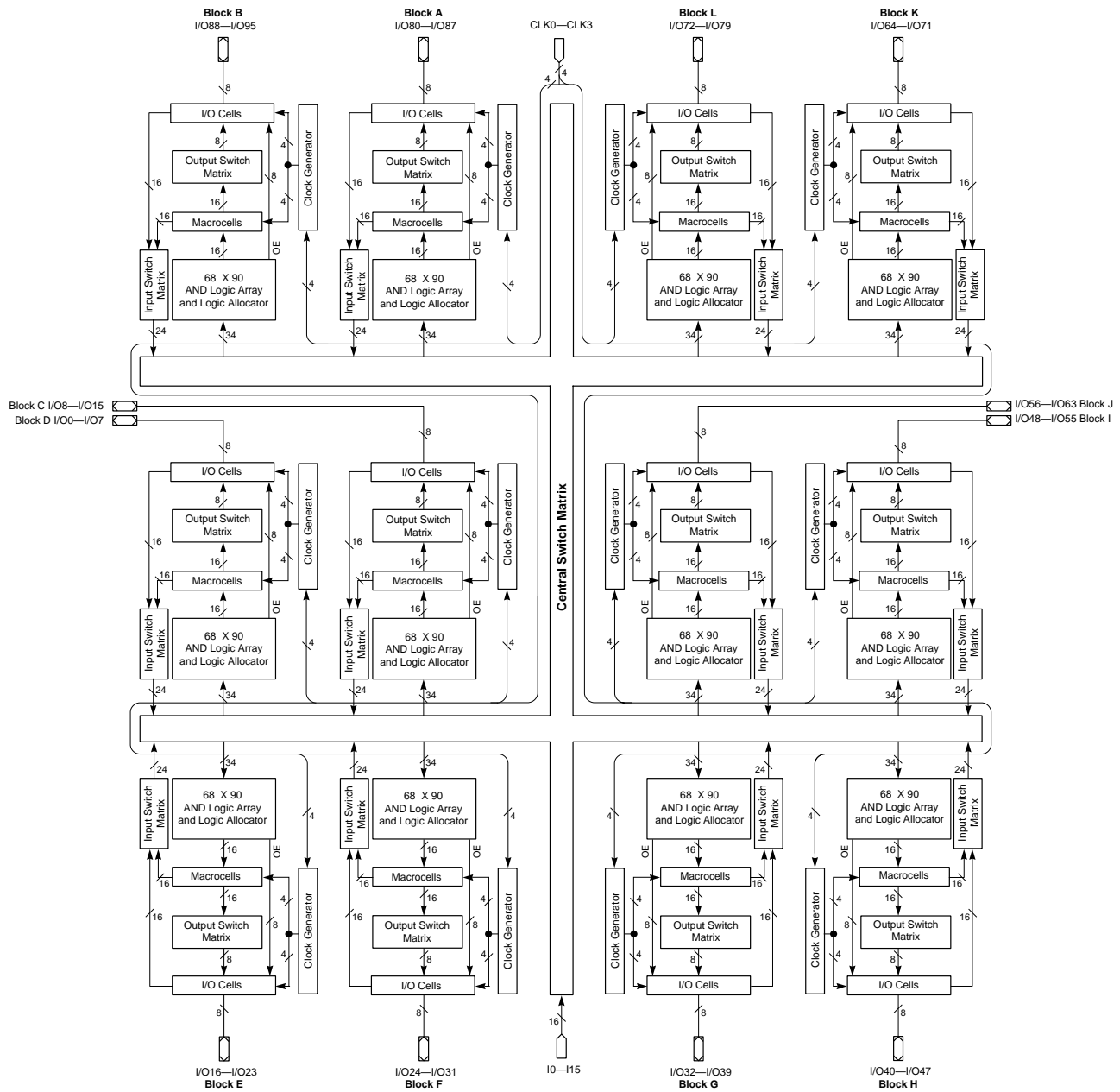

17466G-067

BLOCK DIAGRAM – M4A(3,5)-256/128



17466G-024

BLOCK DIAGRAM – M4A3-256/160, M4A3-256/192

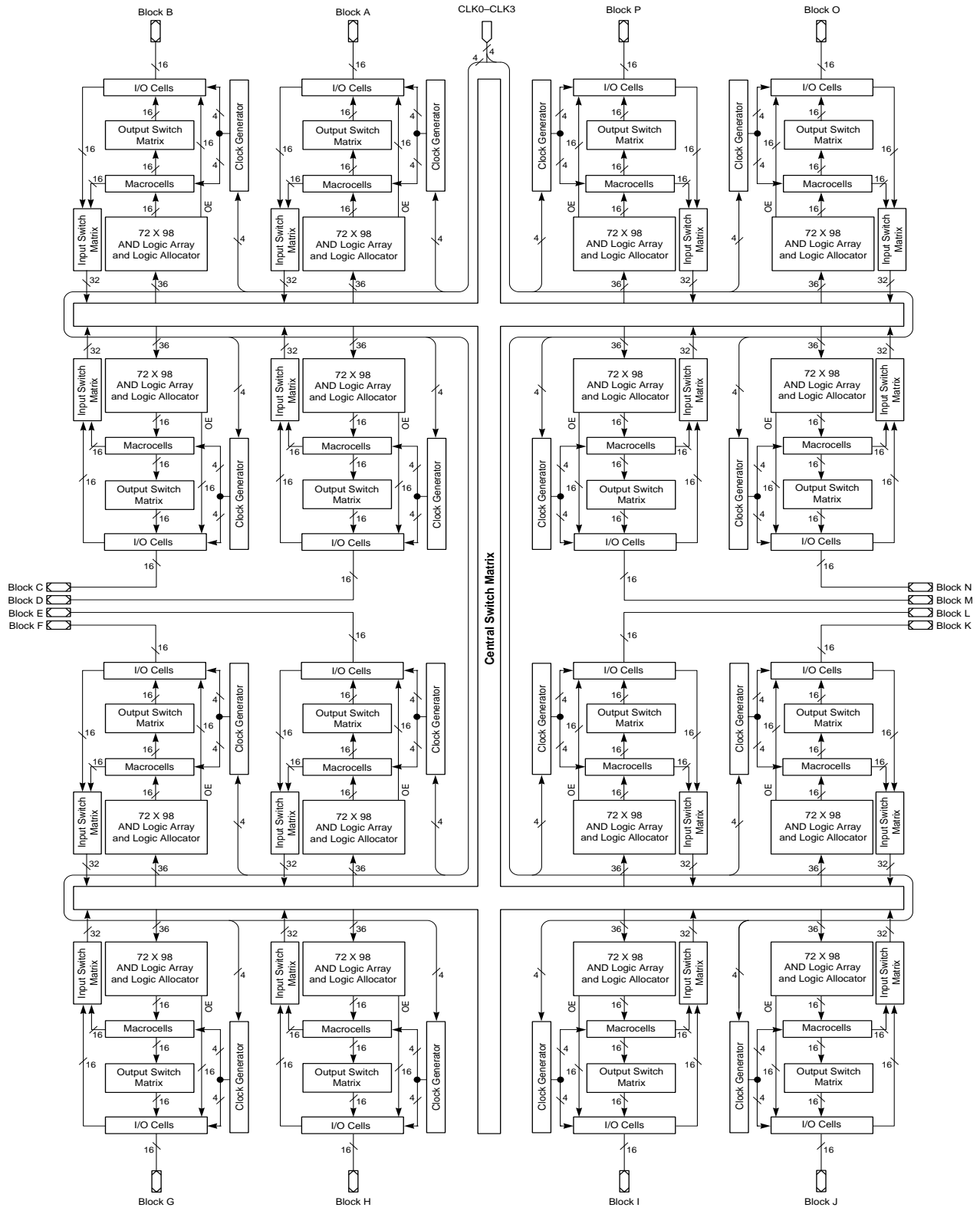

17466G-050

BLOCK DIAGRAM – M4A3-384/160, M4A3-384/192



BLOCK DIAGRAM - M4A3-512/160, M4A3-512/192, M4A3-512/256



17466G-068

ABSOLUTE MAXIMUM RATINGS

M4A5

Storage Temperature	-65°C to +150°C
Ambient Temperature with Power Applied	-55°C to +100°C
Device Junction Temperature	+130°C
Supply Voltage with Respect to Ground	-0.5 V to +7.0 V
DC Input Voltage	-0.5 V to $V_{CC} + 0.5$ V
Static Discharge Voltage	2000 V
Latchup Current ($T_A = -40^\circ\text{C}$ to $+85^\circ\text{C}$)	200 mA

Stresses above those listed under Absolute Maximum Ratings may cause permanent device failure. Functionality at or above these limits is not implied. Exposure to Absolute Maximum Ratings for extended periods may affect device reliability.

OPERATING RANGES

Commercial (C) Devices

Ambient Temperature (T_A) Operating in Free Air	0°C to +70°C
Supply Voltage (V_{CC}) with Respect to Ground	+4.75 V to +5.25 V

Industrial (I) Devices

Ambient Temperature (T_A) Operating in Free Air	-40°C to +85°C
Supply Voltage (V_{CC}) with Respect to Ground	+4.50 V to +5.5 V

Operating ranges define those limits between which the functionality of the device is guaranteed.

5-V DC CHARACTERISTICS OVER OPERATING RANGES

Parameter Symbol	Parameter Description	Test Conditions	Min	Typ	Max	Unit
V_{OH}	Output HIGH Voltage	$I_{OH} = -3.2$ mA, $V_{CC} = \text{Min}$, $V_{IN} = V_{IH}$ or V_{IL}	2.4			V
		$I_{OH} = -100$ μ A, $V_{CC} = \text{Max}$, $V_{IN} = V_{IH}$ or V_{IL}		3.3	3.6	V
V_{OL}	Output LOW Voltage	$I_{OL} = 24$ mA, $V_{CC} = \text{Min}$, $V_{IN} = V_{IH}$ or V_{IL} (Note 1)			0.5	V
V_{IH}	Input HIGH Voltage	Guaranteed Input Logical HIGH Voltage for all Inputs (Note 2)	2.0			V
V_{IL}	Input LOW Voltage	Guaranteed Input Logical LOW Voltage for all Inputs (Note 2)			0.8	V
I_{IH}	Input HIGH Leakage Current	$V_{IN} = 5.25$ V, $V_{CC} = \text{Max}$ (Note 3)			10	μ A
I_{IL}	Input LOW Leakage Current	$V_{IN} = 0$ V, $V_{CC} = \text{Max}$ (Note 3)			-10	μ A
I_{OZH}	Off-State Output Leakage Current HIGH	$V_{OUT} = 5.25$ V, $V_{CC} = \text{Max}$, $V_{IN} = V_{IH}$ or V_{IL} (Note 3)			10	μ A
I_{OZL}	Off-State Output Leakage Current LOW	$V_{OUT} = 0$ V, $V_{CC} = \text{Max}$, $V_{IN} = V_{IH}$ or V_{IL} (Note 3)			-10	μ A
I_{SC}	Output Short-Circuit Current	$V_{OUT} = 0.5$ V, $V_{CC} = \text{Max}$ (Note 4)	-30		-160	mA

Notes:

- Total I_{OL} for one PAL block should not exceed 64 mA.
- These are absolute values with respect to device ground, and all overshoots due to system or tester noise are included.
- I/O pin leakage is the worst case of I_{IL} and I_{OZL} (or I_{IH} and I_{OZH}).
- Not more than one output should be shorted at a time and duration of the short-circuit should not exceed one second. $V_{OUT} = 0.5$ V has been chosen to avoid test problems caused by tester ground degradation.

ABSOLUTE MAXIMUM RATINGS

M4A3

Storage Temperature	-65°C to +150°C
Ambient Temperature with Power Applied	-55°C to +100°C
Device Junction Temperature	+130°C
Supply Voltage with Respect to Ground	-0.5 V to +4.5 V
DC Input Voltage	-0.5 V to 6.0 V
Static Discharge Voltage	2000 V
Latchup Current ($T_A = -40^\circ\text{C}$ to $+85^\circ\text{C}$)	200 mA

Stresses above those listed under Absolute Maximum Ratings may cause permanent device failure. Functionality at or above these limits is not implied. Exposure to Absolute Maximum Ratings for extended periods may affect device reliability.

OPERATING RANGES

Commercial (C) Devices

Ambient Temperature (T_A)	
Operating in Free Air	0°C to +70°C
Supply Voltage (V_{CC}) with Respect to Ground	+3.0 V to +3.6 V

Industrial (I) Devices

Ambient Temperature (T_A)	
Operating in Free Air	-40°C to +85°C
Supply Voltage (V_{CC}) with Respect to Ground	+3.0 V to +3.6 V

Operating ranges define those limits between which the functionality of the device is guaranteed.

3.3-V DC CHARACTERISTICS OVER OPERATING RANGES

Parameter Symbol	Parameter Description	Test Conditions	Min	Typ	Max	Unit
V_{OH}	Output HIGH Voltage	$V_{CC} = \text{Min}$ $V_{IN} = V_{IH}$ or V_{IL}	$I_{OH} = -100 \mu\text{A}$	$V_{CC} - 0.2$		V
			$I_{OH} = -3.2 \text{ mA}$	2.4		V
V_{OL}	Output LOW Voltage	$V_{CC} = \text{Min}$ $V_{IN} = V_{IH}$ or V_{IL} (Note 1)	$I_{OL} = 100 \mu\text{A}$		0.2	V
			$I_{OL} = 24 \text{ mA}$		0.5	V
V_{IH}	Input HIGH Voltage	Guaranteed Input Logical HIGH Voltage for all Inputs	2.0		5.5	V
V_{IL}	Input LOW Voltage	Guaranteed Input Logical LOW Voltage for all Inputs	-0.3		0.8	V
I_{IH}	Input HIGH Leakage Current	$V_{IN} = 3.6 \text{ V}$, $V_{CC} = \text{Max}$ (Note 2)			5	μA
I_{IL}	Input LOW Leakage Current	$V_{IN} = 0 \text{ V}$, $V_{CC} = \text{Max}$ (Note 2)			-5	μA
I_{OZH}	Off-State Output Leakage Current HIGH	$V_{OUT} = 3.6 \text{ V}$, $V_{CC} = \text{Max}$ $V_{IN} = V_{IH}$ or V_{IL} (Note 2)			5	μA
I_{OZL}	Off-State Output Leakage Current LOW	$V_{OUT} = 0 \text{ V}$, $V_{CC} = \text{Max}$ $V_{IN} = V_{IH}$ or V_{IL} (Note 2)			-5	μA
I_{SC}	Output Short-Circuit Current	$V_{OUT} = 0.5 \text{ V}$, $V_{CC} = \text{Max}$ (Note 3)	-15		-160	mA

Notes:

- Total I_{OL} for one PAL block should not exceed 64 mA.
- I/O pin leakage is the worst case of I_{IL} and I_{OZL} (or I_{IH} and I_{OZH}).
- Not more than one output should be shorted at a time and duration of the short-circuit should not exceed one second.

Notes:

- See "MACH Switching Test Circuit" document on the Literature Download page of the Lattice web site.
- This parameter does not apply to flip-flops in the emulated mode since the feedback path is required for emulation.

ispMACH 4A TIMING PARAMETERS OVER OPERATING RANGES¹

		-5		-55		-6		-65		-7		-10		-12		-14		Unit
		Min	Max	Min	Max	Min	Max	Min	Max	Min	Max	Min	Max	Min	Max	Min	Max	
Combinatorial Delay:																		
t_{PDi}	Internal combinatorial propagation delay		3.5		4.0		4.3		4.5		5.0		7.0		9.0		11.0	ns
t_{PD}	Combinatorial propagation delay		5.0		5.5		6.0		6.5		7.5		10.0		12.0		14.0	ns
Registered Delays:																		
t_{SS}	Synchronous clock setup time, D-type register	3.0		3.5		3.5		3.5		5.0		5.5		7.0		10.0		ns
t_{SST}	Synchronous clock setup time, T-type register	4.0		4.0		4.0		4.0		6.0		6.5		8.0		11.0		ns
t_{SA}	Asynchronous clock setup time, D-type register	2.5		2.5		2.5		3.0		3.5		4.0		5.0		8.0		ns
t_{SAT}	Asynchronous clock setup time, T-type register	3.0		3.0		3.0		3.5		4.5		5.0		6.0		9.0		ns
t_{HS}	Synchronous clock hold time	0.0		0.0		0.0		0.0		0.0		0.0		0.0		0.0		ns
t_{HA}	Asynchronous clock hold time	2.5		2.5		2.5		3.0		3.5		4.0		5.0		8.0		ns
t_{COSi}	Synchronous clock to internal output		2.5		2.5		2.8		3.0		3.0		3.0		3.5		3.5	ns
t_{COS}	Synchronous clock to output		4.0		4.0		4.5		5.0		5.5		6.0		6.5		6.5	ns
t_{COAi}	Asynchronous clock to internal output		5.0		5.0		5.0		5.0		6.0		8.0		10.0		12.0	ns
t_{COA}	Asynchronous clock to output		6.5		6.5		6.8		7.0		8.5		11.0		13.0		15.0	ns
Latched Delays:																		
t_{SSL}	Synchronous latch setup time	4.0		4.0		4.0		4.5		6.0		7.0		8.0		10.0		ns
t_{SAL}	Asynchronous latch setup time	3.0		3.0		3.5		3.5		4.0		4.0		5.0		8.0		ns
t_{HSL}	Synchronous latch hold time	0.0		0.0		0.0		0.0		0.0		0.0		0.0		0.0		ns
t_{HAL}	Asynchronous latch hold time	3.0		3.0		3.5		3.5		4.0		4.0		5.0		8.0		ns
t_{PDLi}	Transparent latch to internal output		5.5		5.5		5.8		6.0		7.5		9.0		11.0		12.0	ns
t_{PDL}	Propagation delay through transparent latch to output		7.0		7.0		7.5		8.0		10.0		12.0		14.0		15.0	ns
t_{GOSi}	Synchronous gate to internal output		3.0		3.0		3.0		3.0		3.5		4.5		7.0		8.0	ns
t_{GOS}	Synchronous gate to output		4.5		4.5		4.8		5.0		6.0		7.5		10.0		11.0	ns
t_{GOAi}	Asynchronous gate to internal output		6.0		6.0		6.0		6.0		8.5		10.0		13.0		15.0	ns
t_{GOA}	Asynchronous gate to output		7.5		7.5		7.8		8.0		11.0		13.0		16.0		18.0	ns
Input Register Delays:																		
t_{SIRS}	Input register setup time	1.5		1.5		2.0		2.0		2.0		2.0		2.0		2.0		ns
t_{HIRS}	Input register hold time	2.5		2.5		3.0		3.0		3.0		3.0		3.0		4.0		ns
t_{ICOSi}	Input register clock to internal feedback		3.0		3.0		3.0		3.0		3.5		4.5		6.0		6.0	ns
Input Latch Delays:																		
t_{SIL}	Input latch setup time	1.5		1.5		1.5		2.0		2.0		2.0		2.0		2.0		ns
t_{HIL}	Input latch hold time	2.5		2.5		2.5		3.0		3.0		3.0		3.0		4.0		ns
t_{IGOSi}	Input latch gate to internal feedback		3.5		3.5		3.8		4.0		4.0		4.0		4.0		5.0	ns
t_{PDILi}	Transparent input latch to internal feedback		1.5		1.5		1.5		1.5		2.0		2.0		2.0		2.0	ns

ispMACH 4A TIMING PARAMETERS OVER OPERATING RANGES¹

		-5		-55		-6		-65		-7		-10		-12		-14		Unit
		Min	Max	Min	Max	Min	Max	Min	Max	Min	Max	Min	Max	Min	Max	Min	Max	
Input Register Delays with ZHT Option:																		
t_{SIRZ}	Input register setup time - ZHT	6.0		6.0		6.0		6.0		6.0		6.0		6.0		6.0		ns
t_{HIRZ}	Input register hold time - ZHT	0.0		0.0		0.0		0.0		0.0		0.0		0.0		0.0		ns
Input Latch Delays with ZHT Option:																		
t_{SILZ}	Input latch setup time - ZHT	6.0		6.0		6.0		6.0		6.0		6.0		6.0		6.0		ns
t_{HILZ}	Input latch hold time - ZHT	0.0		0.0		0.0		0.0		0.0		0.0		0.0		0.0		ns
t_{PDIL} Z_i	Transparent input latch to internal feedback - ZHT		6.0		6.0		6.0		6.0		6.0		6.0		6.0		6.0	ns
Output Delays:																		
t_{BUF}	Output buffer delay		1.5		1.5		1.8		2.0		2.5		3.0		3.0		3.0	ns
t_{SIW}	Slow slew rate delay adder		2.5		2.5		2.5		2.5		2.5		2.5		2.5		2.5	ns
t_{EA}	Output enable time		7.5		7.5		8.5		8.5		9.5		10.0		12.0		15.0	ns
t_{ER}	Output disable time		7.5		7.5		8.5		8.5		9.5		10.0		12.0		15.0	ns
Power Delay:																		
t_{PL}	Power-down mode delay adder		2.5		2.5		2.5		2.5		2.5		2.5		2.5		2.5	ns
Reset and Preset Delays:																		
t_{SRi}	Asynchronous reset or preset to internal register output		7.5		7.7		8.0		8.0		9.5		11.0		13.0		16.0	ns
t_{SR}	Asynchronous reset or preset to register output		9.0		9.2		10.0		10.0		12.0		14.0		16.0		19.0	ns
t_{SRR}	Asynchronous reset and preset register recovery time	7.0		7.0		7.5		7.5		8.0		8.0		10.0		15.0		ns
t_{SRW}	Asynchronous reset or preset width	7.0		7.0		8.0		8.0		10.0		10.0		12.0		15.0		ns
Clock/LE Width:																		
t_{WLS}	Global clock width low	2.0		2.0		2.5		2.5		3.0		4.0		5.0		6.0		ns
t_{WHS}	Global clock width high	2.0		2.0		2.5		2.5		3.0		4.0		5.0		6.0		ns
t_{WLA}	Product term clock width low	3.0		3.0		3.5		3.5		4.0		5.0		8.0		9.0		ns
t_{WHA}	Product term clock width high	3.0		3.0		3.5		3.5		4.0		5.0		8.0		9.0		ns
t_{CWS}	Global gate width low (for low transparent) or high (for high transparent)	4.0		4.0		4.5		4.5		5.0		5.0		6.0		6.0		ns
t_{CWA}	Product term gate width low (for low transparent) or high (for high transparent)	4.0		4.0		4.5		4.5		5.0		5.0		6.0		9.0		ns
t_{WIRL}	Input register clock width low	3.0		3.0		3.5		3.5		4.0		5.0		6.0		6.0		ns
t_{WIRH}	Input register clock width high	3.0		3.0		3.5		3.5		4.0		5.0		6.0		6.0		ns
t_{WIL}	Input latch gate width	4.0		4.0		4.5		4.5		5.0		5.0		6.0		6.0		ns

ispMACH 4A TIMING PARAMETERS OVER OPERATING RANGES¹

		-5		-55		-6		-65		-7		-10		-12		-14		Unit
		Min	Max	Min	Max	Min	Max	Min	Max	Min	Max	Min	Max	Min	Max	Min	Max	
Frequency:																		
f_{MAXS}	External feedback, D-type, Min of $1/(t_{WIS} + t_{WHS})$ or $1/(t_{SS} + t_{COS})$	143		133		125		118		95.2		87.0		74.1		60.6		MHz
	External feedback, T-type, Min of $1/(t_{WIS} + t_{WHS})$ or $1/(t_{SST} + t_{COS})$	125		125		118		111		87.0		80.0		69.0		57.1		MHz
	Internal feedback (f_{CNT}), D-type, Min of $1/(t_{WIS} + t_{WHS})$ or $1/(t_{SS} + t_{COSi})$	182		167		160		154		125		118		95.0		74.1		MHz
	Internal feedback (f_{CNT}), T-type, Min of $1/(t_{WIS} + t_{WHS})$ or $1/(t_{SST} + t_{COSi})$	154		154		148		143		111		105		87.0		69.0		MHz
	No feedback ² , Min of $1/(t_{WIS} + t_{WHS})$, $1/(t_{SS} + t_{HS})$ or $1/(t_{SST} + t_{HS})$	250		250		200		200		154		125		100		83.3		MHz
f_{MAXA}	External feedback, D-type, Min of $1/(t_{WLA} + t_{WHA})$ or $1/(t_{SA} + t_{COA})$	111		111		108		100		83.3		66.7		55.6		43.5		MHz
	External feedback, T-type, Min of $1/(t_{WLA} + t_{WHA})$ or $1/(t_{SAT} + t_{COA})$	105		105		102		95.2		76.9		62.5		52.6		41.7		MHz
	Internal feedback (f_{CNTA}), D-type, Min of $1/(t_{WLA} + t_{WHA})$ or $1/(t_{SA} + t_{COAi})$	133		133		125		125		105		83.3		66.7		50.0		MHz
	Internal feedback (f_{CNTA}), T-type, Min of $1/(t_{WLA} + t_{WHA})$ or $1/(t_{SAT} + t_{COAi})$	125		125		125		118		95.2		76.9		62.5		47.6		MHz
	No feedback ² , Min of $1/(t_{WLA} + t_{WHA})$, $1/(t_{SA} + t_{HA})$ or $1/(t_{SAT} + t_{HA})$	167		167		143		143		125		100		62.5		55.6		MHz
f_{MAXI}	Maximum input register frequency, Min of $1/(t_{WIRH} + t_{WIRL})$ or $1/(t_{SIRS} + t_{HIRS})$	167		167		143		143		125		100		83.3		83.3		MHz

Notes:

1. See "Switching Test Circuit" document on the Literature Download page of the Lattice web site.
2. This parameter does not apply to flip-flops in the emulated mode since the feedback path is required for emulation.

CAPACITANCE¹

Parameter Symbol	Parameter Description	Test Conditions		Typ	Unit
C_{IN}	Input capacitance	$V_{IN}=2.0\text{ V}$	3.3 V or 5 V, 25°C, 1 MHz	6	pF
$C_{I/O}$	Output capacitance	$V_{OUT}=2.0\text{ V}$	3.3 V or 5 V, 25°C, 1 MHz	8	pF

Note:

1. These parameters are not 100% tested, but are calculated at initial characterization and at any time the design is modified where this parameter may be affected.

I_{CC} vs. FREQUENCY

These curves represent the typical power consumption for a particular device at system frequency. The selected “typical” pattern is a 16-bit up-down counter. This pattern fills the device and exercises every macrocell. Maximum frequency shown uses internal feedback and a D-type register. Power/Speed are optimized to obtain the highest counter frequency and the lowest power. The highest frequency (LSBs) is placed in common PAL blocks, which are set to high power. The lowest frequency signals (MSBs) are placed in a common PAL block and set to lowest power.

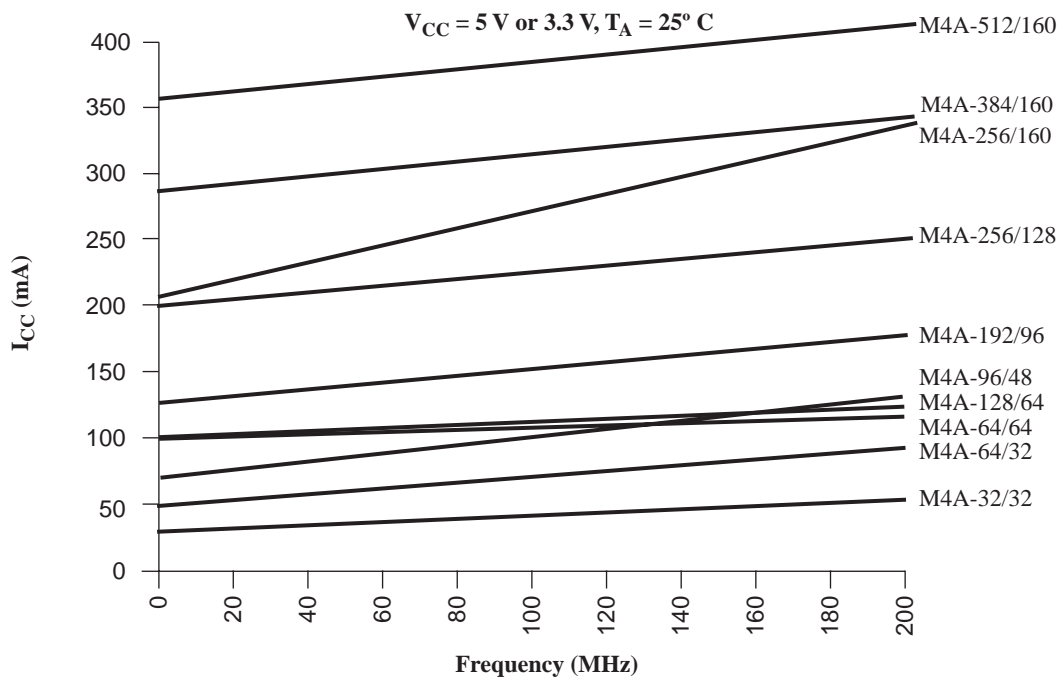

Figure 19. ispMACH 4A I_{CC} Curves at High Speed Mode

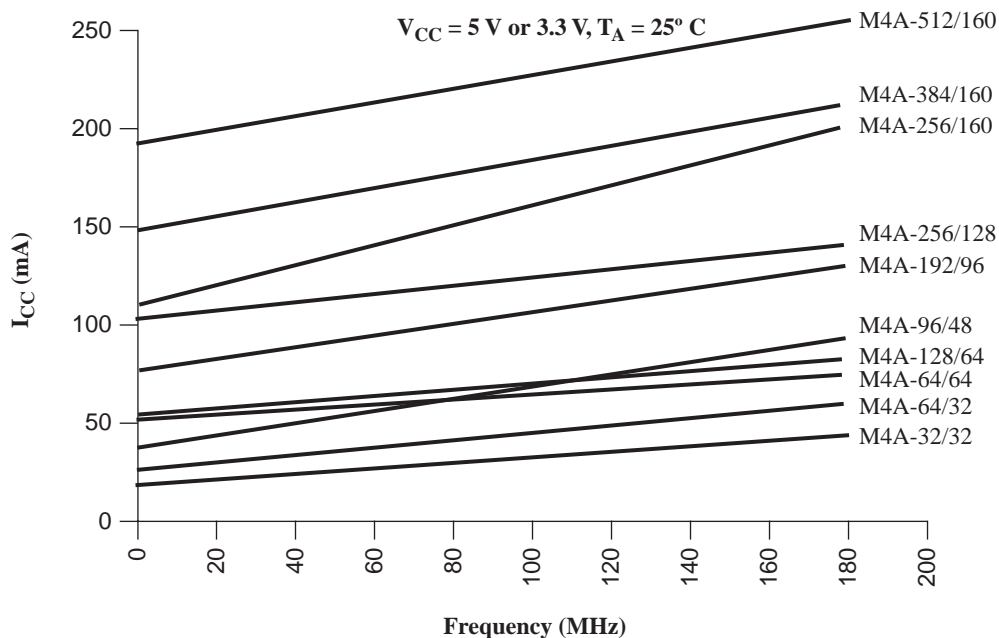

Figure 20. ispMACH 4A I_{CC} Curves at Low Power Mode

44-PIN PLCC CONNECTION DIAGRAM (M4A(3,5)-32/32 AND M4A(3,5)-64/32)

Top View



17466G-026

PIN DESIGNATIONS

CLK/I = Clock or Input

GND = Ground

I/O = Input/Output

V_{CC} = Supply Voltage

TDI = Test Data In

TCK = Test Clock

TMS = Test Mode Select

TDO = Test Data Out

44-PIN TQFP CONNECTION DIAGRAM (M4A(3,5)-32/32 AND M4A(3,5)-64/32)

Top View

44-Pin TQFP (1.0mm Thickness)



PIN DESIGNATIONS

- CLK/I = Clock or Input
- GND = Ground
- I/O = Input/Output
- V_{CC} = Supply Voltage
- TDI = Test Data In
- TCK = Test Clock
- TMS = Test Mode Select
- TDO = Test Data Out

48-PIN TQFP CONNECTION DIAGRAM (M4A(3,5)-32/32 AND M4A(3,5)-64/32)

Top View

48-Pin TQFP (1.4mm Thickness)



17466G-028

PIN DESIGNATIONS

- CLK/I = Clock or Input
- GND = Ground
- I/O = Input/Output
- V_{CC} = Supply Voltage
- NC = No Connect
- TDI = Test Data In
- TCK = Test Clock
- TMS = Test Mode Select
- TDO = Test Data Out

100-PIN TQFP CONNECTION DIAGRAM (M4A(3,5)-96/48)

Top View



PIN DESIGNATIONS

- CLK/I = Clock or Input
- GND = Ground
- I = Input
- I/O = Input/Output
- V_{CC} = Supply Voltage
- NC = No Connect
- TDI = Test Data In
- TCK = Test Clock
- TMS = Test Mode Select
- TDO = Test Data Out

100-PIN PQFP CONNECTION DIAGRAM (M4A(3,5)-128/64)

Top View



PIN DESIGNATIONS

I/CLK = Input or Clock

GND = Ground

I = Input

I/O = Input/Output

V_{CC} = Supply Voltage

TDI = Test Data In

TCK = Test Clock

TMS = Test Mode Select

TDO = Test Data Out

TRST = Test Reset

ENABLE = Program

100-PIN TQFP CONNECTION DIAGRAM (M4A3-64/64 AND M4A(3,5)-128/64)

Top View



PIN DESIGNATIONS

CLK/I = Clock or Input

GND = Ground

I = Input

I/O = Input/Output

V_{CC} = Supply Voltage

TDI = Test Data In

TCK = Test Clock

TMS = Test Mode Select

TDO = Test Data Out

TRST = Test Reset

ENABLE = Program

100-BALL caBGA CONNECTION DIAGRAM (M4A3-128/64)

Bottom View

100-Ball caBGA

	10	9	8	7	6	5	4	3	2	1	
A	GND	I/O63 H7	I/O60 H4	I/O57 H1	GND	GND	I/O1 A1	I/O4 A4	I/O7 A7	GND	A
B	$\overline{\text{TRST}}$	GND	I/O61 H5	I5	VCC	I/O0 A0	I/O6 A6	GND	TDI	I/O15 B7	B
C	I/O53 G5	TDO	I/O62 H6	I/O58 H2	I/O56 H0	I/O2 A2	GND	I/O14 B6	I/O13 B5	I/O12 B4	C
D	I/O50 G2	I/O55 G7	GND	I/O59 H3	I/O3 A3	I/O5 A5	I/O11 B3	I/O10 B2	CLK0/I0	I/O9 B1	D
E	CLK3/I4	I/O49 G1	I/O51 G3	I/O54 G6	VCC	I/O16 C0	I/O20 C4	I/O8 B0	VCC	GND	E
F	GND	VCC	I/O40 F0	I/O52 G4	I/O48 G0	VCC	I/O22 C6	I/O19 C3	I/O17 C1	CLK1/I1	F
G	I/O41 F1	CLK2/I3	I/O42 F2	I/O43 F3	I/O37 E5	I/O35 E3	I/O27 D3	GND	I/O23 C7	I/O18 C2	G
H	I/O44 F4	I/O45 F5	I/O46 F6	GND	I/O34 E2	I/O24 D0	I/O26 D2	I/O30 D6	TCK	I/O21 C5	H
J	I/O47 F7	$\overline{\text{ENABLE}}$	GND	I/O38 E6	I/O32 E0	VCC	I2	I/O29 D5	GND	TMS	J
K	GND	I/O39 E7	I/O36 E4	I/O33 E1	GND	GND	I/O25 D1	I/O28 D4	I/O31 D7	GND	K

PIN DESIGNATIONS

CLK = Clock
 GND = Ground
 I = Input
 I/O = Input/Output
 N/C = No Connect
 VCC = Supply Voltage
 TDI = Test Data In
 TCK = Test Clock
 TMS = Test Mode Select
 TDO = Test Data Out
 $\overline{\text{TRST}}$ = Test Reset
 ENABLE = Program



17466G-100cabga

144-PIN TQFP CONNECTION DIAGRAM (M4A(3,5)-192/96)

Top View



17466G-033

PIN DESIGNATIONS

- CLK = Clock
- GND = Ground
- I = Input
- I/O = Input/Output
- V_{CC} = Supply Voltage
- TDI = Test Data In
- TCK = Test Clock
- TMS = Test Mode Select
- TDO = Test Data Out

144-BALL FPBGA CONNECTION DIAGRAM (M4A3-192/96)

Bottom View

144-Ball fpBGA

	12	11	10	9	8	7	6	5	4	3	2	1	
A	GND	I/O72 L7	I/O76 L3	I13	GBCLK3	I0	I/O82 A2	I/O86 A6	I/O88 B0	I/O93 B5	I/O95 B7	GND	A
B	GND	I/O73 L6	I/O77 L2	I/O79 L0	VCC	I1	I/O83 A3	I/O87 A7	I/O90 B2	I/O94 B6	I/O0 D7	TDI	B
C	GND	TD0	I/O74 L5	I14	GND	I/O80 A0	I/O84 A4	GND	I/O92 B4	I/O1 D6	I/O4 D3	I/O3 D4	C
D	I/O67 K4	I/O69 K2	I/O71 K0	I/O75 L4	GBCLK0	I/O81 A1	VCC	I/O91 B3	I/O2 D5	I2	I/O6 D1	I/O7 D0	D
E	I12	I/O64 K7	I/O66 K5	I/O70 K1	I/O78 L1	I/O85 A5	I/O89 B1	I/O5 D2	I/O8 C7	I4	GND	VCC	E
F	I10	I11	GND	I/O65 K6	I/O68 K3	I15	I3	GND	I/O12 C3	I/O11 C4	I/O10 C5	I/O9 C6	F
G	I/O60 J3	I/O61 J2	I/O62 J1	I/O63 J0	VCC	GND	I7	I/O20 E3	I/O17 E6	I/O15 C0	I/O14 C1	I/O13 C2	G
H	I/O56 J7	I/O57 J6	I/O58 J5	I/O59 J4	I/O53 I2	I/O41 H1	I/O37 G5	I/O30 F1	I/O22 E1	I/O18 E5	I/O16 E7	VCC	H
J	I/O55 I0	I/O54 I1	VCC	I/O50 I5	I/O43 H3	VCC	I/O33 G1	GBCLK2	I/O27 F4	I/O23 E0	I/O21 E2	I/O19 E4	J
K	I/O51 I4	I/O52 I3	I/O49 I6	I/O44 H4	GND	I/O36 G4	I/O32 G0	VCC	I6	I/O26 F5	TCK	TMS	K
L	GND	I/O48 I7	I/O46 H6	I/O42 H2	I/O39 G7	I/O35 G3	I9	GND	I/O31 F0	I/O29 F2	I/O25 F6	GND	L
M	GND	I/O47 H7	I/O45 H5	I/O40 H0	I/O38 G6	I/O34 G2	I8	GBCLK1	I5	I/O28 F3	I/O24 F7	GND	M
	12	11	10	9	8	7	6	5	4	3	2	1	

PIN DESIGNATIONS

CLK = Clock
 GND = Ground
 I = Input
 I/O = Input/Output
 N/C = No Connect
 VCC = Supply Voltage
 TDI = Test Data In
 TCK = Test Clock
 TMS = Test Mode Select
 TD0 = Test Data Out



208-PIN PQFP CONNECTION DIAGRAM (M4A(3,5)-256/128 AND M4A3-256/160)

Top View

208-Pin PQFP



17466G-044

208-PIN PQFP CONNECTION DIAGRAM (M4A3-384/160 AND M4A3-512/160)

Top View

208-Pin PQFP



17466Ga-044

256-BALL BGA CONNECTION DIAGRAM (M4A3-256/128)

Bottom View

256-Ball BGA

	20	19	18	17	16	15	14	13	12	11	10	9	8	7	6	5	4	3	2	1	
A	GND	N/C	GND	I/O108 N4	I/O105 N1	GND	I/O100 M4	I/O96 M0	GND	GND	GND	GND	I/O95 L0	I/O91 L4	GND	I/O87 K0	N/C	GND	GND	GND	A
B	GND	I/O113 O6	N/C	I/O109 N5	I/O106 N2	I/O103 M7	I/O102 M6	I/O98 M2	N/C	I11	N/C	N/C	I/O93 L2	I/O89 L6	I/O88 L7	I/O85 K2	I/O83 K4	I/O82 K5	N/C	GND	B
C	I/O116 O3	N/C	VCC	TRST	I/O111 N7	I/O107 N3	I/O104 N0	I/O101 M5	I/O97 M1	N/C	I10	I/O94 L1	I/O90 L5	I/O86 K1	I/O84 K3	I/O80 K7	ENABLE	VCC	I/O78 J6	I/O74 J2	C
D	I/O120 P7	I/O117 O2	I/O112 O7	VCC	VCC	I/O110 N6	VCC	N/C	I/O99 M3	N/C	I9	I/O92 L3	N/C	VCC	I/O81 K6	VCC	VCC	I/O79 J7	I/O75 J3	I/O71 I7	D
E	I/O123 P4	I/O119 O0	I/O114 O5	TDI	<p style="text-align: center;">PIN DESIGNATIONS</p> <p> CLK = Clock GND = Ground I = Input I/O = Input/Output N/C = No Connect VCC = Supply Voltage TDI = Test Data In TCK = Test Clock TMS = Test Mode Select TDO = Test Data Out TRST = Test Reset ENABLE = Program </p>												TDO	I/O77 J5	I/O72 J0	I/O68 I4	E
F	GND	I/O122 P5	I/O118 O1	I/O115 O4													I/O76 J4	I/O73 J1	I/O69 I5	GND	F
G	I12	I/O125 P2	I/O121 P6	VCC													VCC	I/O70 I6	I/O65 I1	I8	G
H	GND	I/O127 P0	I/O126 P1	I/O124 P3													I/O67 I3	I/O66 I2	I/O64 I0	GND	H
J	N/C	N/C	N/C	I13													I7	N/C	N/C	N/C	J
K	GND	CLK3	N/C	N/C													N/C	N/C	CLK2	N/C	K
L	N/C	CLK0	N/C	N/C													N/C	N/C	CLK1	GND	L
M	N/C	N/C	N/C	I0													I6	N/C	I/O63 H0	I/O62 H1	M
N	GND	I/O0 A0	I/O2 A2	I/O3 A3													I/O60 H3	I/O61 H2	I/O59 H4	GND	N
P	I1	I/O1 A1	I/O6 A6	VCC													VCC	I/O57 H6	I/O58 H5	I5	P
R	GND	I/O5 A5	I/O9 B1	N/C	I/O51 G4	I/O54 G1	I/O56 H7	GND	R												
T	I/O4 A4	I/O8 B0	I/O12 B4	TCK	TMS	I/O50 G5	I/O55 G0	N/C	T												
U	I/O7 A7	I/O11 B3	I/O15 B7	VCC	VCC	I/O18 C5	VCC	I/O24 D7	I/O29 D2	I2	N/C	I/O35 E3	N/C	VCC	N/C	VCC	VCC	I/O48 G7	I/O53 G2	N/C	U
V	I/O10 B2	I/O13 B5	VCC	I/O16 C7	I/O17 C6	I/O21 C2	I/O23 C0	I/O27 D4	I/O31 D0	I3	N/C	I/O33 E1	I/O37 E5	I/O41 F1	I/O43 F3	I/O46 F6	I/O47 F7	VCC	I/O52 G3	N/C	V
W	GND	I/O14 B6	N/C	N/C	I/O19 C4	I/O22 C1	I/O25 D6	I/O28 D3	N/C	N/C	I4	N/C	I/O34 E2	I/O38 E6	I/O39 E7	I/O42 F2	I/O45 F5	N/C	I/O49 G6	GND	W
Y	GND	GND	GND	N/C	I/O20 C3	GND	I/O26 D5	I/O30 D1	GND	GND	GND	GND	I/O32 E0	I/O36 E4	GND	I/O40 F0	I/O44 F4	GND	N/C	GND	Y
	20	19	18	17	16	15	14	13	12	11	10	9	8	7	6	5	4	3	2	1	

17466G-045

256-BALL fpBGA CONNECTION DIAGRAM (M4A3-256/192)

Bottom View

256-Ball fpBGA

	16	15	14	13	12	11	10	9	8	7	6	5	4	3	2	1	
A	I/O167 N15	I/O181 O13	I/O180 O12	I/O177 O9	I/O174 O6	I/O172 O4	I/O191 P14	I/O186 P4	I/O1 A2	I/O3 A6	GCLK0	I/O9 B1	I/O13 B5	I/O15 B7	I/O18 B10	I/O20 B12	A
B	I/O165 N13	I/O166 N14	I/O182 O14	I/O179 O11	I/O175 O7	I/O173 O5	I/O168 O0	I/O187 P6	I/O0 A0	I/O5 A10	I/O7 A14	I/O10 B2	I/O16 B8	I/O19 B11	I/O21 B13	NC	B
C	I/O163 N11	I/O164 N12	NC	I/O183 O15	I/O178 O10	I/O170 O2	I/O171 O3	I/O189 P10	I/O184 P0	I/O6 A12	I/O12 B4	I/O14 B6	I/O23 B15	I/O22 B14	TDI	I/O39 C15	C
D	I/O158 N6	I/O159 N7	TDO	GND	GND	VCC	GND	VCC	GND	GND	VCC	GND	VCC	I/O17 B9	I/O38 C14	I/O37 C13	D
E	I/O156 N4	NC	I/O162 N10	VCC	I/O160 N8	I/O161 N9	I/O190 P12	GCLK3	I/O188 P8	I/O2 A4	I/O8 B0	NC	GND	I/O36 C12	I/O35 C11	I/O31 C7	E
F	I/O152 N0	I/O157 N5	I/O155 N3	GND	I/O154 N2	I/O153 N1	I/O176 O8	I/O169 O1	I/O185 P2	I/O4 A8	I/O11 B3	I/O34 C10	VCC	I/O32 C8	I/O30 C6	I/O29 C5	F
G	I/O147 M6	I/O150 M12	I/O149 M10	VCC	I/O148 M8	I/O151 M14	VCC	GND	GND	VCC	I/O33 C9	I/O28 C4	GND	I/O26 C2	I/O25 C1	I/O47 D14	G
H	I/O144 M0	I/O146 M4	I/O145 OM2	GND	I/O136 L0	I/O137 L2	GND	VCC	VCC	GND	I/O27 C3	I/O24 C0	VCC	I/O44 D8	I/O43 D6	I/O42 D4	H
J	I/O138 L4	I/O139 L6	I/O140 L8	GND	I/O142 L12	I/O141 L10	GND	VCC	VCC	GND	I/O46 D12	I/O45 D10	GND	I/O49 E2	I/O48 E0	I/O50 E4	J
K	I/O143 L14	I/O120 K0	I/O121 K1	VCC	I/O123 K3	I/O122 K2	VCC	GND	GND	VCC	I/O41 D2	I/O40 D0	VCC	I/O55 E14	I/O54 E12	I/O56 F0	K
L	I/O124 K4	I/O125 K5	I/O127 K7	GND	I/O130 K10	I/O126 K6	I/O98 I4	I/O91 H6	I/O75 G3	I/O77 G5	I/O52 E8	I/O51 E6	GND	I/O59 F3	I/O60 F4	I/O57 F1	L
M	I/O128 K8	I/O129 K9	I/O131 K11	GND	I/O107 J3	I/O105 J1	I/O100 I8	I/O90 H4	I/O74 G2	I/O80 G8	I/O83 G11	I/O53 E10	VCC	I/O68 F12	I/O63 F7	I/O58 F2	M
N	I/O132 K12	I/O133 K13	I/O135 K15	VCC	GND	VCC	GND	VCC	GND	GND	VCC	GND	GND	TCK	I/O64 F8	I/O61 F5	N
P	I/O134 K14	I/O117 J13	I/O118 J14	I/O119 J15	I/O108 J4	I/O106 J2	I/O101 I10	I/O89 H2	I/O93 H10	I/O94 H12	I/O79 G7	I/O84 G12	I/O87 G15	TMS	I/O65 F9	I/O62 F6	P
R	I/O116 J12	I/O115 J11	I/O112 J8	I/O111 J7	I/O104 J0	I/O102 I12	I/O99 I6	I/O96 I0	I/O92 H8	I/O72 G0	I/O76 G4	I/O81 G9	I/O85 G13	I/O71 F15	I/O67 F11	I/O66 F10	R
T	I/O114 J10	I/O113 J9	I/O110 J6	I/O109 J5	I/O103 I14	GCLK2	I/O97 I2	I/O88 H0	GCLK1	I/O95 H14	I/O73 G1	I/O78 G6	I/O82 G10	I/O86 G14	I/O70 F14	I/O69 F13	T

PIN DESIGNATIONS

CLK = Clock
 GND = Ground
 I = Input
 I/O = Input/Output
 N/C = No Connect
 VCC = Supply Voltage
 TDI = Test Data In
 TCK = Test Clock
 TMS = Test Mode Select
 TDO = Test Data Out



17466G-047

256-BALL BGA CONNECTION DIAGRAM - (M4A3-384/192)

Bottom View

256-Ball BGA

	20	19	18	17	16	15	14	13	12	11	10	9	8	7	6	5	4	3	2	1													
A	GND	I/O11 FX7	GND	I/O44 FX6	I/O58 CX6	GND	I/O70 CX2	I/O76 DX6	GND	GND	GND	GND	I/O108 AX5	I/O116 BX0	GND	I/O128 BX7	I/O134 O3	GND	GND	GND	A												
B	GND	I/O12 GX7	I/O28 FX5	I/O45 FX3	I/O59 CX7	I/O64 CX5	I/O71 CX3	I/O77 DX7	I/O84 DX5	I/O90 DX2	I/O96 AX0	I/O102 AX3	I/O109 AX6	I/O117 BX1	I/O122 BX4	I/O129 BX6	I/O135 O4	I/O148 O6	I/O164 O7	GND	B												
C	I/O0 GX6	I/O13 GX5	VCC	I/O46 FX4	I/O60 FX2	I/O65 FX1	I/O72 CX4	I/O78 CX0	I/O85 DX4	I/O91 DX1	I/O97 AX1	I/O103 AX4	I/O110 BX2	I/O118 BX5	I/O123 O0	I/O130 O1	I/O136 O5	VCC	I/O165 N7	I/O181 N6	C												
D	I/O1 EX7	I/O14 GX3	I/O29 GX4	VCC	VCC	I/O66 FX0	VCC	I/O79 CX1	I/O86 DX3	I/O92 DX0	I/O98 AX2	I/O104 AX7	I/O111 BX3	VCC	I/O124 O2	VCC	VCC	VCC	I/O149 N4	I/O166 N5	I/O182 P7	D											
E	I/O2 EX0	I/O15 GX0	I/O30 GX1	TDI	<p style="text-align: center;">PIN DESIGNATIONS</p> <p> CLK = Clock GND = Ground I = Input I/O = Input/Output N/C = No Connect VCC = Supply Voltage TDI = Test Data In TCK = Test Clock TMS = Test Mode Select TDO = Test Data Out </p>												TDO	I/O150 N2	I/O167 N3	I/O183 P6	E												
F	GND	I/O16 EX1	I/O31 EX6	I/O47 GX2																									I/O137 N1	I/O151 N0	I/O168 P5	GND	F
G	I/O3 HX6	I/O17 EX4	I/O32 EX5	VCC																									VCC	I/O152 P4	I/O169 P3	I/O184 M7	G
H	GND	I/O18 HX5	I/O33 EX2	I/O48 EX3																									I/O138 P2	I/O153 P1	I/O170 P0	GND	H
J	I/O4 HX0	I/O19 HX1	I/O34 HX4	I/O49 HX7																									I/O139 M6	I/O154 M5	I/O171 M4	I/O185 M3	J
K	GND	CLK3	I/O35 HX2	I/O50 HX3																									I/O140 M0	I/O155 M1	CLK2	I/O186 M2	K
L	I/O5 A2	CLK0	I/O36 A0	I/O51 A1																									I/O141 L3	I/O156 L4	CLK1	GND	L
M	I/O6 A4	I/O20 A3	I/O37 A5	I/O52 A6																									I/O142 L6	I/O157 L5	I/O172 L0	I/O187 L1	M
N	GND	I/O21 A7	I/O38 D0	I/O53 D1																									I/O143 I5	I/O158 I0	I/O173 L7	GND	N
P	I/O7 D2	I/O22 D3	I/O39 D4	VCC																									VCC	I/O159 I4	I/O174 I1	I/O188 L2	P
R	GND	I/O23 D5	I/O40 D6	I/O54 D7													I/O144 K5	I/O160 K0	I/O175 I3	GND	R												
T	I/O8 B3	I/O24 B0	I/O41 B7	TCK													TMS	I/O161 K4	I/O176 K1	I/O189 I2	T												
U	I/O9 B4	I/O25 B1	I/O42 B6	VCC	VCC	I/O67 C0	VCC	I/O80 F0	I/O87 E5	I/O93 E2	I/O99 H2	I/O105 H5	I/O112 G0	VCC	I/O125 J1	VCC	VCC	I/O162 K7	I/O177 K2	I/O190 I6	U												
V	I/O10 B5	I/O26 B2	VCC	I/O55 C5	I/O61 C2	I/O68 C1	I/O73 F4	I/O81 F1	I/O88 E4	I/O94 E1	I/O100 H1	I/O106 H4	I/O113 G1	I/O119 G4	I/O126 J0	I/O131 J2	I/O145 J5	VCC	I/O178 K3	I/O191 I7	V												
W	GND	I/O27 C7	I/O43 C6	I/O56 C3	I/O62 F7	I/O69 F5	I/O74 F3	I/O82 E7	I/O89 E3	I/O95 E0	I/O101 H0	I/O107 H3	I/O114 H7	I/O120 G3	I/O127 G5	I/O132 G7	I/O146 J4	I/O163 J6	I/O179 J7	GND	W												
Y	GND	GND	GND	I/O57 C4	I/O63 F6	GND	I/O75 F2	I/O83 E6	GND	GND	GND	GND	I/O115 H6	I/O121 G2	GND	I/O133 G6	I/O147 J3	GND	I/O180 K6	GND	Y												
	20	19	18	17	16	15	14	13	12	11	10	9	8	7	6	5	4	3	2	1													

17466G-046

256-BALL fpBGA CONNECTION DIAGRAM (M4A3-256/128)

Bottom View

256-Ball fpBGA

	16	15	14	13	12	11	10	9	8	7	6	5	4	3	2	1	
A	TRST	I/O117 O5	I/O116 O4	I/O113 O1	I/O126 P6	I/O124 P4	I12	NC	NC	NC	CLK0	I/O1 A1	I/O5 A5	I/O7 A7	I/O10 B2	I/O12 B4	A
B	I/O110 N6	I/O111 N7	I/O118 O6	I/O115 O3	I/O127 P7	I/O125 P5	I/O120 P0	NC	NC	NC	I1	I/O2 A2	I/O8 B0	I/O11 B3	I/O13 B5	NC	B
C	I/O108 N4	I/O109 N5	NC	I/O119 O7	I/O114 O2	I/O122 P2	I/O123 P3	NC	NC	I0	I/O4 A4	I/O6 A6	I/O15 B7	I/O14 B6	TDI	I/O23 C7	C
D	NC	I/O104 N0	TDO	GND	GND	VCC	GND	VCC	GND	GND	VCC	GND	VCC	I/O9 B1	I/O22 C6	I/O21 C5	D
E	I/O102 M6	NC	I/O107 N3	VCC	I/O105 N1	I/O106 N2	I13	CLK3	NC	NC	I/O0 A0	NC	GND	I/O20 C4	I/O19 C3	I/O31 D7	E
F	I/O98 M2	I/O103 M7	I/O101 M5	GND	I/O100 M4	I/O99 M3	I/O112 O0	I/O121 P1	NC	NC	I/O3 A3	I/O18 C2	VCC	I/O16 C0	I/O30 D6	I/O29 D5	F
G	NC	I/O96 M0	I11	VCC	NC	I/O97 M1	VCC	GND	GND	VCC	I/O17 C1	I/O28 D4	GND	I/O26 D2	I/O25 D1	I2	G
H	I/O88 L0	I10	I9	GND	I/O89 L1	I/O90 L2	GND	VCC	VCC	GND	I/O27 D3	I/O24 D0	VCC	NC	NC	NC	H
J	I/O91 L3	I/O92 L4	I/O93 L5	GND	I/O95 L7	I/O94 L6	GND	VCC	VCC	GND	I3	NC	GND	NC	NC	NC	J
K	NC	NC	NC	VCC	NC	NC	VCC	GND	GND	VCC	NC	NC	VCC	I4	NC	I/O32 E0	K
L	NC	NC	I/O80 K0	GND	I/O83 K3	NC	NC	NC	I/O59 H3	I/O61 H5	NC	NC	GND	I/O35 E3	I/O36 E4	I/O33 E1	L
M	I/O81 K1	I/O82 K2	I/O84 K4	GND	I/O67 I3	I/O65 I1	NC	NC	I/O58 H2	I/O48 G0	I/O51 G3	NC	VCC	I/O44 F4	I/O39 E7	I/O34 E2	M
N	I/O85 K5	I/O86 K6	ENABLE	VCC	GND	VCC	GND	VCC	GND	GND	VCC	GND	GND	TCK	I/O40 F0	I/O37 E5	N
P	I/O87 K7	I/O77 J5	I/O78 J6	I/O79 J7	I/O68 I4	I/O66 I2	NC	NC	NC	I6	I/O63 H7	I/O52 G4	I/O55 G7	TMS	I/O41 F1	I/O38 E6	P
R	I/O76 J4	I/O75 J3	I/O72 J0	I/O71 I7	I/O64 I0	I7	NC	NC	NC	I/O56 H0	I/O60 H4	I/O49 G1	I/O53 G5	I/O47 F7	I/O43 F3	I/O42 F2	R
T	I/O74 J2	I/O73 J1	I/O70 I6	I/O69 I5	I8	CLK2	NC	NC	CLK1	I5	I/O57 H1	I/O62 H6	I/O50 G2	I/O54 G6	I/O46 F6	I/O45 F5	T

PIN DESIGNATIONS

- CLK = Clock
- GND = Ground
- I = Input
- I/O = Input/Output
- N/C = No Connect
- VCC = Supply Voltage
- TDI = Test Data In
- TCK = Test Clock
- TMS = Test Mode Select
- TDO = Test Data Out
- TRST = Test Reset
- ENABLE = Program



m4a3.256.128_256bga

256-BALL fpBGA CONNECTION DIAGRAM (M4A3-384/192)

Bottom View

256-Ball fpBGA

	16	15	14	13	12	11	10	9	8	7	6	5	4	3	2	1	
A	I/O175 FX7	I/O181 GX5	I/O180 GX4	I/O177 GX1	I/O166 EX6	I/O164 EX4	I/O191 HX7	I/O186 HX2	I/O1 A1	I/O3 A3	CLK0	I/O25 D1	I/O29 D5	I/O31 D7	I/O10 B2	I/O12 B4	A
B	I/O173 FX5	I/O174 FX6	I/O182 GX6	I/O179 GX3	I/O167 EX7	I/O165 EX5	I/O160 EX0	I/O187 HX3	I/O0 A0	I/O5 A5	I/O7 A7	I/O26 D2	I/O8 B0	I/O11 B3	I/O13 B5	N/C	B
C	I/O171 FX3	I/O172 FX4	N/C	I/O183 GX7	I/O178 GX2	I/O162 EX2	I/O163 EX3	I/O189 HX5	I/O184 HX0	I/O6 A6	I/O28 D4	I/O30 D6	I/O15 B7	I/O14 B6	TDI	I/O23 C7	C
D	I/O150 CX6	I/O151 CX7	TDO	GND	GND	VCC	GND	VCC	GND	GND	VCC	GND	VCC	I/O9 B1	I/O22 C6	I/O21 C5	D
E	I/O148 CX4	N/C	I/O170 FX2	VCC	I/O168 FX0	169 FX1	I/O190 HX6	CLK3	I/O188 HX4	I/O2 A2	I/O24 D0	N/C	GND	I/O20 C4	I/O19 C3	I/O47 F7	E
F	I/O144 CX0	I/O149 CX5	I/O147 CX3	GND	I/O146 CX2	I/O145 CX1	I/O176 GX0	I/O161 EX1	I/O185 HX1	I/O4 A4	I/O27 D3	I/O18 C2	VCC	I/O16 C0	I/O46 F6	I/O45 F5	F
G	I/O155 DX3	I/O158 DX6	I/O157 DX5	VCC	I/O156 DX4	I/O159 DX7	VCC	GND	GND	VCC	I/O17 C1	I/O44 F4	GND	I/O42 F2	I/O41 F1	I/O39 E7	G
H	I/O152 DX0	I/O154 DX2	I/O153 DX1	GND	I/O128 AX0	I/O129 AX1	GND	VCC	VCC	GND	I/O43 F3	I/O40 F0	VCC	I/O36 E4	I/O35 E3	I/O34 E2	H
J	I/O130 AX2	I/O131 AX3	I/O132 AX4	GND	I/O134 AX6	I/O133 AX5	GND	VCC	VCC	GND	I/O38 E6	I/O37 E5	GND	I/O57 H1	I/O56 H0	I/O58 H2	J
K	I/O135 AX7	I/O136 BX0	I/O137 BX1	VCC	I/O139 BX3	I/O138 BX2	VCC	GND	GND	VCC	I/O33 E1	I/O32 E0	VCC	I/O63 H7	I/O62 H6	I/O48 G0	K
L	I/O140 BX4	I/O141 BX5	I/O143 BX7	GND	I/O114 O2	I/O142 BX6	I/O98 M2	I/O91 L3	I/O67 I3	I/O69 I5	I/O60 H4	I/O59 H3	GND	I/O51 G3	I/O52 G4	I/O49 G1	L
M	I/O112 O0	I/O113 O1	I/O115 O3	GND	I/O123 P3	I/O121 P1	I/O100 M4	I/O90 L2	I/O66 I2	I/O80 K0	I/O83 K3	I/O61 H5	VCC	I/O76 J4	I/O55 G7	I/O50 G2	M
N	I/O116 O4	I/O117 O5	I/O119 O7	VCC	GND	VCC	GND	VCC	GND	GND	VCC	GND	GND	TCK	I/O72 J0	I/O53 G5	N
P	I/O118 O6	I/O109 N5	I/O110 N6	I/O111 N7	I/O124 P4	I/O122 P2	I/O101 M5	I/O89 L1	I/O93 L5	I/O94 L6	I/O71 I7	I/O84 K4	I/O87 K7	TMS	I/O73 J1	I/O54 G6	P
R	I/O108 N4	I/O107 N3	I/O104 N0	I/O127 P7	I/O120 P0	I/O102 M6	I/O99 M3	I/O96 M0	I/O92 L4	I/O64 I0	I/O68 I4	I/O81 K1	I/O85 K5	I/O79 J7	I/O75 J3	I/O74 J2	R
T	I/O106 N2	I/O105 N1	I/O126 P6	I/O125 P5	I/O103 M7	CLK2	I/O97 M1	I/O88 L0	CLK1	I/O95 L7	I/O65 I1	I/O70 I6	I/O82 K2	I/O86 K6	I/O78 J6	I/O77 J5	T

PIN DESIGNATIONS

CLK = Clock
 GND = Ground
 I = Input
 I/O = Input/Output
 N/C = No Connect
 VCC = Supply Voltage
 TDI = Test Data In
 TCK = Test Clock
 TMS = Test Mode Select
 TDO = Test Data Out



256-BALL fpBGA CONNECTION DIAGRAM (M4A3-512/192)

Bottom View

256-Ball fpBGA

	16	15	14	13	12	11	10	9	8	7	6	5	4	3	2	1	
A	I/O159 KX7	I/O181 OX5	I/O180 OX4	I/O177 OX1	I/O174 NX6	I/O172 NX4	I/O191 PX7	I/O186 PX2	I/O1 A1	I/O3 A3	CLK0	I/O17 C1	I/O21 C5	I/O23 C7	I/O10 B2	I/O12 B4	A
B	I/O157 KX5	I/O158 KX6	I/O182 OX6	I/O179 OX3	I/O175 NX7	I/O173 NX5	I/O168 NX0	I/O187 PX3	I/O0 A0	I/O5 A5	I/O7 A7	I/O18 C2	I/O8 B0	I/O11 B3	I/O13 B5	N/C	B
C	I/O155 KX3	I/O156 KX4	N/C	I/O183 OX7	I/O178 OX2	I/O170 NX2	I/O171 NX3	I/O189 PX5	I/O184 PX0	I/O6 A6	I/O20 C4	I/O22 C6	I/O15 B7	I/O14 B6	TDI	I/O39 F7	C
D	I/O150 JX6	I/O151 JX7	TDO	GND	GND	VCC	GND	VCC	GND	GND	VCC	GND	VCC	I/O9 B1	I/O38 F6	I/O37 F5	D
E	I/O148 JX4	N/C	I/O154 KX2	VCC	I/O152 KX0	I/O153 KX1	I/O190 PX6	CLK3	I/O188 PX4	I/O2 A2	I/O16 C0	N/C	GND	I/O36 F4	I/O35 F3	I/O47 G7	E
F	I/O144 JX0	I/O149 JX5	I/O147 JX3	GND	I/O146 JX2	I/O145 JX1	I/O176 OX0	I/O169 NX1	I/O185 PX1	I/O4 A4	I/O19 C3	I/O34 F2	VCC	I/O32 F0	I/O46 G6	I/O45 G5	F
G	I/O163 LX3	I/O166 LX6	I/O165 LX5	VCC	I/O164 LX4	I/O167 LX7	VCC	GND	GND	VCC	I/O33 F1	I/O44 G4	GND	I/O42 G2	I/O41 G1	I/O31 E7	G
H	I/O160 LX0	I/O162 LX2	I/O161 LX1	GND	I/O120 EX0	I/O121 EX1	GND	VCC	VCC	GND	I/O43 G3	I/O40 G0	VCC	I/O28 E4	I/O27 E3	I/O26 E2	H
J	I/O122 EX2	I/O123 EX3	I/O124 EX4	GND	I/O126 EX6	I/O125 EX5	GND	VCC	VCC	GND	I/O30 E6	I/O29 E5	GND	I/O65 L1	I/O64 L0	I/O66 L2	J
K	I/O127 EX7	I/O136 GX0	I/O137 GX1	VCC	I/O139 GX3	I/O138 GX2	VCC	GND	GND	VCC	I/O25 E1	I/O24 E0	VCC	I/O71 L7	I/O70 L6	I/O48 J0	K
L	I/O140 GX4	I/O141 GX5	I/O143 GX7	GND	I/O130 FX2	I/O142 GX6	I/O98 AX2	I/O91 P3	I/O75 N3	I/O77 N5	I/O68 L4	I/O67 L3	GND	I/O51 J3	I/O52 J4	I/O49 J1	L
M	I/O128 FX0	I/O129 FX1	I/O131 FX3	GND	I/O115 CX3	I/O113 CX1	I/O100 AX4	I/O90 P2	I/O74 N2	I/O80 O0	I/O83 O3	I/O69 L5	VCC	I/O60 K4	I/O55 J7	I/O50 J2	M
N	I/O132 FX4	I/O133 FX5	I/O135 FX7	VCC	GND	VCC	GND	VCC	GND	GND	VCC	GND	GND	TCK	I/O56 K0	I/O53 J5	N
P	I/O134 FX6	I/O109 BX5	I/O110 BX6	I/O111 BX7	I/O116 CX4	I/O114 CX2	I/O101 AX5	I/O89 P1	I/O93 P5	I/O94 P6	I/O79 N7	I/O84 O4	I/O87 O7	TMS	I/O57 K1	I/O54 J6	P
R	I/O108 BX4	I/O107 BX3	I/O104 BX0	I/O119 CX7	I/O112 CX0	I/O102 AX6	I/O99 AX3	I/O96 AX0	I/O92 P4	I/O72 N0	I/O76 N4	I/O81 O1	I/O85 O5	I/O63 K7	I/O59 K3	I/O58 K2	R
T	I/O106 BX2	I/O105 BX1	I/O118 CX6	I/O117 CX5	I/O103 AX7	CLK2	I/O97 AX1	I/O88 P0	CLK1	I/O95 P7	I/O73 N1	I/O78 N6	I/O82 O2	I/O86 O6	I/O62 K6	I/O61 K5	T

PIN DESIGNATIONS

- CLK = Clock
- GND = Ground
- I = Input
- I/O = Input/Output
- N/C = No Connect
- VCC = Supply Voltage
- TDI = Test Data In
- TCK = Test Clock
- TMS = Test Mode Select
- TDO = Test Data Out



388-BALL fpBGA CONNECTION DIAGRAM (M4A3-512/256)

Bottom View

388-Ball fpBGA

	22	21	20	19	18	17	16	15	14	13	12	11	10	9	8	7	6	5	4	3	2	1	
A	GND	I/O243 OX3	I/O240 OX0	I/O241 OX1	I/O236 NX4	I/O231 MX7	I/O228 MX4	I/O226 MX2	I/O255 PX7	I/O251 PX3	I/O248 PX0	I/O0 A0	I/O5 A5	I/O6 A6	I/O27 D3	I/O30 D6	I/O17 C1	I/O22 C6	I/O8 B0	I/O10 B2	N/C	GND	A
B	N/C	GND	I/O245 OX5	I/O242 OX2	I/O238 NX6	I/O234 NX2	I/O232 NX0	I/O229 MX5	I/O224 MX0	I/O253 PX5	I/O249 PX1	I/O2 A2	CLK0	I/O26 D2	I/O29 D5	I/O31 D7	I/O20 C4	I/O9 B1	I/O12 B4	I/O13 B5	GND	TDI	B
C	I/O213 KX5	TDO	GND	I/O247 OX7	I/O244 OX4	I/O239 NX7	I/O235 NX3	I/O230 MX6	I/O227 MX3	CLK3	I/O250 PX2	I/O1 A1	I/O7 A7	I/O25 D1	I/O16 C0	I/O18 C2	I/O23 C7	I/O11 B3	I/O15 B7	GND	I/O47 F7	I/O44 F4	C
D	I/O210 KX2	I/O212 KX4	I/O215 KX7	GND	I/O246 OX6	VCC	I/O237 NX5	I/O233 NX1	VCC	I/O254 PX6	VCC	I/O3 A3	I/O24 D0	VCC	I/O19 C3	I/O21 C5	VCC	I/O14 B6	GND	I/O46 F6	I/O43 F3	I/O41 F1	D
E	I/O207 JX7	I/O209 KX1	I/O211 KX3	I/O214 KX6															I/O45 F5	I/O42 F2	I/O40 F0	I/O54 G6	E
F	I/O203 JX3	I/O205 JX5	I/O208 KX0	VCC															VCC	I/O55 G7	I/O52 G4	I/O50 G2	F
G	I/O200 JX0	I/O202 JX2	I/O204 JX4	I/O206 JX6			VCC	VCC	N/C	I/O225 MX1	I/O252 PX4	I/O4 A4	I/O28 D4	N/C	VCC	VCC			I/O53 G5	I/O51 G3	I/O49 G1	I/O39 E7	G
H	I/O221 LX5	I/O222 LX6	I/O223 LX7	I/O201 JX1			VCC	N/C	GND	GND	GND	GND	GND	GND	N/C	VCC			I/O48 G0	I/O38 E6	I/O37 E5	I/O36 E4	H
J	I/O218 LX2	I/O219 LX3	I/O220 LX4	VCC			N/C	GND	GND	GND	GND	GND	GND	GND	GND	N/C			VCC	I/O35 E3	I/O34 E2	I/O32 E0	J
K	I/O197 IX5	I/O198 IX6	I/O199 IX7	I/O216 LX0			I/O217 LX1	GND	GND	GND	GND	GND	GND	GND	GND	I/O33 E1			I/O63 H7	I/O62 H6	I/O61 H5	I/O60 H4	K
L	I/O192 IX0	I/O194 IX2	I/O195 IX3	I/O196 IX4			I/O193 IX1	GND	GND	GND	GND	GND	GND	GND	GND	I/O58 H2			VCC	I/O59 H3	I/O57 H1	I/O56 H0	L
M	I/O184 HX0	I/O185 HX1	I/O187 HX3	VCC			I/O186 HX2	GND	GND	GND	GND	GND	GND	GND	GND	I/O69 I5			I/O67 I3	I/O65 I1	I/O66 I2	I/O64 I0	M
N	I/O188 HX4	I/O189 HX5	I/O191 HX7	I/O190 HX6			I/O182 EX2	GND	GND	GND	GND	GND	GND	GND	GND	I/O89 L1			I/O88 L0	I/O71 I7	I/O70 I6	I/O68 I4	N
P	I/O160 EX0	I/O161 EX1	I/O163 EX3	VCC			N/C	GND	GND	GND	GND	GND	GND	GND	GND	N/C			VCC	I/O92 L4	I/O91 L3	I/O90 L2	P
R	I/O164 EX4	I/O165 EX5	I/O166 EX6	I/O177 GX1			VCC	N/C	GND	GND	GND	GND	GND	GND	N/C	VCC			I/O74 J2	I/O95 L7	I/O94 L6	I/O93 L5	R
T	I/O167 EX7	I/O176 GX0	I/O179 GX3	I/O181 GX5			VCC	VCC	N/C	I/O152 DX0	I/O131 AX3	I/O122 P2	I/O98 M2	N/C	VCC	VCC			I/O78 J6	I/O76 J4	I/O73 J1	I/O72 J0	T
U	I/O178 GX2	I/O180 GX4	I/O183 GX7	VCC															VCC	I/O80 K0	I/O77 J5	I/O75 J3	U
V	I/O182 GX6	N/C	I/O169 FX1	I/O172 FX4															I/O86 K6	I/O83 K3	I/O81 K1	I/O79 J7	V
W	I/O168 FX0	I/O170 FX2	I/O173 FX5	GND	I/O143 BX7	VCC	I/O150 CX6	I/O145 CX1	VCC	I/O153 DX1	I/O123 P3	VCC	I/O96 M0	VCC	I/O104 N0	I/O111 N7	VCC	I/O119 O7	GND	I/O87 K7	I/O84 K4	I/O82 K2	W
Y	I/O171 FX3	I/O174 FX6	GND	I/O141 BX5	I/O138 BX2	I/O136 BX0	I/O147 CX3	I/O158 DX6	I/O156 DX4	CLK2	I/O132 AX4	I/O121 P1	I/O125 P5	I/O99 M3	I/O101 M5	I/O106 N2	I/O110 N6	I/O115 O3	I/O118 O6	GND	TMS	I/O85 K5	Y
AA	I/O175 FX7	GND	I/O142 BX6	I/O140 BX4	I/O151 CX7	I/O149 CX5	I/O144 CX0	I/O157 DX5	I/O154 DX2	I/O134 AX6	I/O130 AX2	I/O128 AX0	CLK1	I/O127 P7	I/O100 M4	I/O103 M7	I/O108 N4	I/O109 N5	I/O113 O1	I/O116 O4	GND	TCK	AA
AB	GND	N/C	I/O139 BX3	I/O137 BX1	I/O148 CX4	I/O146 CX2	I/O159 DX7	I/O155 DX3	I/O135 AX7	I/O133 AX5	I/O129 AX1	I/O120 P0	I/O124 P4	I/O126 P6	I/O97 M1	I/O102 M6	I/O105 N1	I/O107 N3	I/O112 O0	I/O114 O2	I/O117 O5	GND	AB

PIN DESIGNATIONS

- CLK = Clock
- GND = Ground
- I = Input
- I/O = Input/Output
- N/C = No Connect
- VCC = Supply Voltage
- TDI = Test Data In
- TCK = Test Clock
- TMS = Test Mode Select
- TDO = Test Data Out



m4a3.512.256_388bga

ispMACH 4A PRODUCT ORDERING INFORMATION

ispMACH 4A Devices Commercial and Industrial - 3.3V and 5V

Lattice programmable logic products are available with several ordering options. The order number (Valid Combination) is formed by a combination of:

	M4A3-	256 / 128	-7	Y	C		
FAMILY TYPE						48	= 48-pin TQFP for M4A3-32/32 or M4A3-64/32 M4A5-32/32 or M4A5-64/32
M4A3- = ispMACH 4A Family Low Voltage Advanced Feature (3.3-V V_{CC})							OPERATING CONDITIONS C = Commercial (0°C to +70°C) I = Industrial (-40°C to +85°C)
M4A5- = ispMACH 4A Family Advanced Feature (5-V V_{CC})							
MACROCELL DENSITY							PACKAGE TYPE
32 = 32 Macrocells	192 = 192 Macrocells						SA = Ball Grid Array (BGA)
64 = 64 Macrocells	256 = 256 Macrocells						J = Plastic Leaded Chip Carrier (PLCC)
96 = 96 Macrocells	384 = 384 Macrocells						JN = Lead-free Plastic Leaded Chip Carrier (PLCC)
128 = 128 Macrocells	512 = 512 Macrocells						V = Thin Quad Flat Pack (TQFP)
							VN = Lead-free Thin Quad Flat Pack (TQFP)
I/Os							Y = Plastic Quad Flat Pack (PQFP)
/32 = 32 I/Os in 44-pin PLCC, 44-pin TQFP or 48-pin TQFP							YN = Lead-free Plastic Quad Flat Pack (PQFP)
/48 = 48 I/Os in 100-pin TQFP							FA = Fine-pitch Ball Grid Array (fpBGA)
/64 = 64 I/Os in 100-pin TQFP, 100-pin PQFP, or 100-ball caBGA							FAN = Lead-free Fine-pitch Ball Grid Array (fpBGA)
/96 = 96 I/Os in 144-pin TQFP or 144-ball fpBGA							CA = Chip-array Ball Grid Array (caBGA)
/128 = 128 I/Os in 208-pin PQFP, 256-ball BGA or 256-ball fpBGA							
/160 = 160 I/Os in 208-pin PQFP							
/192 = 192 I/Os in 256-ball BGA or 256-ball fpBGA							
/256 = 256 I/Os in 388-ball fpBGA							
							SPEED
							-5 = 5.0 ns t_{PD}
							-55 = 5.5 ns t_{PD}
							-6 = 6.0 ns t_{PD}
							-65 = 6.5 ns t_{PD}
							-7 = 7.5 ns t_{PD}
							-10 = 10 ns t_{PD}
							-12 = 12 ns t_{PD}
							-14 = 14 ns t_{PD}

*Package obsolete, contact factory.

Conventional Packaging

3.3V Commercial Combinations		
M4A3-32/32	-5, -7, -10	JC, VC, VC48
M4A3-64/32		JC, VC, VC48
M4A3-64/64		VC
M4A3-96/48	-55, -7, -10	VC
M4A3-128/64		YC, VC, CAC
M4A3-192/96	-6, -7, -10	VC, FAC
M4A3-256/128	-55, -65 ¹ , -7, -10	YC, FAC, SAC
M4A3-256/160		YC
M4A3-256/192	-7, -10	FAC
M4A3-384/160		YC
M4A3-384/192	-65, -10, -12	SAC, FAC
M4A3-512/160		YC
M4A3-512/192	-7, -10, -12	FAC
M4A3-512/256		FAC

3.3V Industrial Combinations		
M4A3-32/32		JI, VI, VI48
M4A3-64/32		JI, VI, VI48
M4A3-64/64		VI
M4A3-96/48	-7, -10, -12	VI
M4A3-128/64		YI, VI, CAI
M4A3-192/96		VI, FAI
M4A3-256/128		YI, FAI, SAI
M4A3-256/160		YI
M4A3-256/192	-10, -12	FAI
M4A3-384/160		YI
M4A3-384/192		FAI
M4A3-512/160	-10, -12, -14	YI
M4A3-512/192		FAI
M4A3-512/256		FAI

1. Use 5.5ns for new designs.

5V Commercial Combinations		
M4A5-32/32	-5, -7, -10,	JC, VC, VC48
M4A5-64/32	-55, -7, -10	JC, VC, VC48
M4A5-96/48		VC
M4A5-128/64		YC, VC
M4A5-192/96	-6, -7, -10	VC
M4A5-256/128	-65, -7, -10	YC

5V Industrial Combinations		
M4A5-32/32	-7, -10, -12	JJ, VI, VI48
M4A5-64/32	-7, -10, -12	JJ, VI, VI48
M4A5-96/48		VI
M4A5-128/64		YI, VI
M4A5-192/96	-7, -10, -12	VI
M4A5-256/128	-10, -12	YI

Lead-free Packaging

3.3V Commercial Combinations		
M4A3-32/32	-5, -7, -10	VNC, VNC48, JNC
M4A3-64/32	-55, -7, -10	VNC, VNC48, JNC
M4A3-64/64		VNC
M4A3-128/64		VNC
M4A3-192/96	-6, -7, -10	VNC
M4A3-256/128	-55, -7, -10	FANC, YNC
M4A3-256/160	-7, -10	YNC
M4A3-256/192		FANC
M4A3-384/192	-65, -10, -12	FANC
M4A3-512/192	-7, -10, -12	FANC

3.3V Industrial Combinations		
M4A3-32/32	-7, -10, -12	VNI, VNI48, JNI
M4A3-64/32		VNI, VNI48, JNI
M4A3-64/64		VNI
M4A3-128/64		VNI
M4A3-192/96	-10, -12	VNI
M4A3-256/128		FANI, YNI
M4A3-256/160		YNI
M4A3-256/192	-10, -12, -14	FANI
M4A3-384/192		FANI
M4A3-512/192		FANI

5V Commercial Combinations		
M4A5-32/32	-5, -7, -10	VNC, VNC48, JNC
M4A5-64/32	-55, -7, -10	VNC, VNC48, JNC
M4A5-96/48		VNC
M4A5-128/64		VNC, YNC
M4A5-192/96	-6, -7, -10	VNC
M4A5-256/128	-65, -7, -10	YNC

5V Industrial Combinations		
M4A5-32/32	-7, -10, -12	VNI, VNI48, JNI
M4A5-64/32		VNI, VNI48, JNI
M4A5-96/48		VNI
M4A5-128/64		VNI, YNI
M4A5-192/96		VNI
M4A5-256/128		YNI

Most ispMACH devices are dual-marked with both Commercial and Industrial grades. The Industrial speed grade is slower, i.e., M4A3-256/128-7YC-10YI

Valid Combinations

Valid Combinations list configurations planned to be supported in volume for this device. Consult the local Lattice sales office to confirm availability of specific valid combinations and to check on newly released combinations.

Revision History

Date	Version	Change Summary
-	K	Previous Lattice release.
August 2006	L	Updated for lead-free package options.
September 2006	M	Revised M4A3-256/160 208-pin PQFP connection diagram.



Компания «ЭлектроПласт» предлагает заключение долгосрочных отношений при поставках импортных электронных компонентов на взаимовыгодных условиях!

Наши преимущества:

- Оперативные поставки широкого спектра электронных компонентов отечественного и импортного производства напрямую от производителей и с крупнейших мировых складов;
- Поставка более 17-ти миллионов наименований электронных компонентов;
- Поставка сложных, дефицитных, либо снятых с производства позиций;
- Оперативные сроки поставки под заказ (от 5 рабочих дней);
- Экспресс доставка в любую точку России;
- Техническая поддержка проекта, помощь в подборе аналогов, поставка прототипов;
- Система менеджмента качества сертифицирована по Международному стандарту ISO 9001;
- Лицензия ФСБ на осуществление работ с использованием сведений, составляющих государственную тайну;
- Поставка специализированных компонентов (Xilinx, Altera, Analog Devices, Intersil, Interpoint, Microsemi, Aeroflex, Peregrine, Syfer, Eurofarad, Texas Instrument, Miteq, Cobham, E2V, MA-COM, Hittite, Mini-Circuits, General Dynamics и др.);

Помимо этого, одним из направлений компании «ЭлектроПласт» является направление «Источники питания». Мы предлагаем Вам помощь Конструкторского отдела:

- Подбор оптимального решения, техническое обоснование при выборе компонента;
- Подбор аналогов;
- Консультации по применению компонента;
- Поставка образцов и прототипов;
- Техническая поддержка проекта;
- Защита от снятия компонента с производства.



Как с нами связаться

Телефон: 8 (812) 309 58 32 (многоканальный)

Факс: 8 (812) 320-02-42

Электронная почта: org@eplast1.ru

Адрес: 198099, г. Санкт-Петербург, ул. Калинина, дом 2, корпус 4, литера А.