

**High Current Synchronous Step-Up Regulator
with Programmable Current Limit**

General Description

The AAT2215 SwitchReg™ is a high current, synchronous step-up converter with a programmable peak NMOS current limit. It is ideal to prevent the input current from overloading the system power in PC Card GSM/GPRS/3G and WiMax modem card applications. The AAT2215's internal compensation is optimized for the large bulk tantalum output capacitors needed to support the output voltage during large load pulses.

The output voltage may be programmed from 3.0V to 5.5V by external resistor divider. Light load switching frequency modulation and low quiescent current maintain high efficiency performance for light load mode conditions.

Two current limits are designed into the AAT2215. One is the low-side power MOSFET programmable peak current limit, which works when the device is in step-up regulation state. An external resistor is used to program the current limit from 600mA to 4.0A. The other is the high-side current limit, which operates in a linear mode to limit inrush current to 750mA when the output charges up to the input voltage. The AAT2215 includes internal over-voltage protection and a system ready signal.

The AAT2215 is available in a Pb-free, 3mm x 3mm, 12-pin TDFN package (TDFN33-12) rated from -40°C to +85°C.

Features

- 2.4V to $V_{OUT} + 0.25V$ Input Voltage Range
- Adjustable 3.0V to 5.5V Output Voltage
- Internal Compensation
- 600kHz Switching Frequency
- Programmable Peak NMOS Current Limit (0.6A to 4.0A)
- Synchronous P-Channel MOSFET
 - True Load Disconnect in Shutdown
 - Reverse Current Block When Enabled
 - Start-Up Inrush Current Limit (0.75A) and Overload Current Limit (3A)
- Up to 95% Efficiency
- Active-Low Power Ready Indicator (\overline{RDY})
- Very Low 55µA No-Load Operating Current
- Less than 1µA Shutdown Current
- 6V Output Over-Voltage Protection (OVP)
- Thermal Shutdown Protection (TSHDN)
- Short Circuit Protection
- Low-Profile TDFN33-12 Package

Applications

- Media Tablets
- PCI-Express Cards
- PCMCIA Cards
- Modems
- Wireless Data Cards

Typical Application Figure

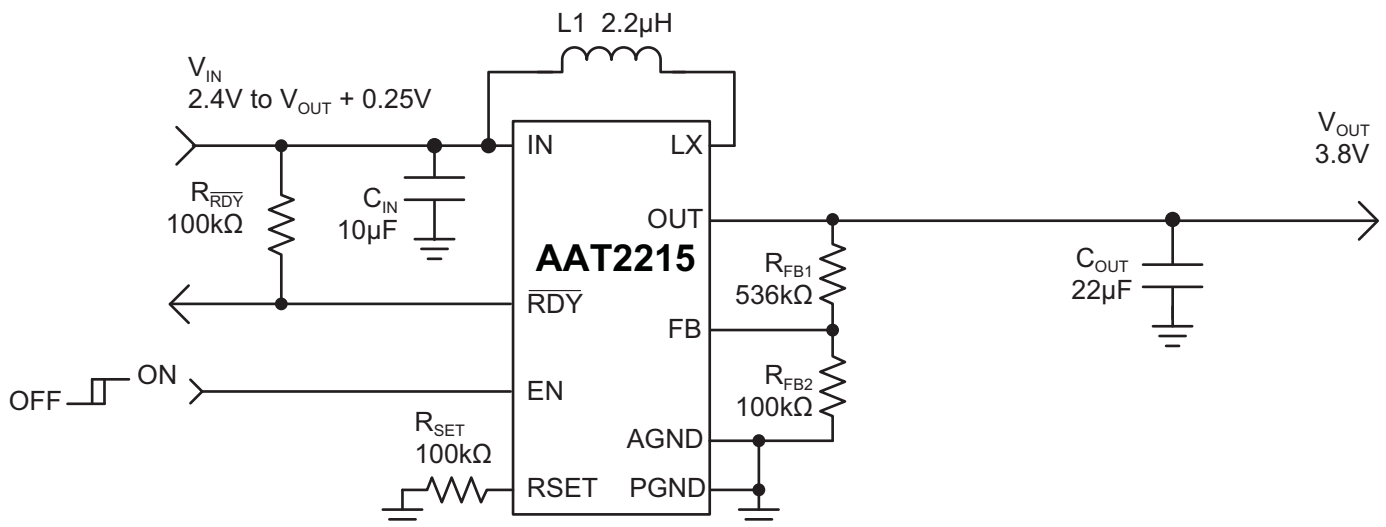

AAT2215

High Current Synchronous Step-Up Regulator with Programmable Current Limit

Pin Descriptions

Pin	Name	Function
1, 2	LX	Inductor switching node. LX is internally connected to the source of the internal low-side N-channel MOSFET (NMOS), and synchronous high-side P-channel MOSFET (PMOS). Externally connected to the switching side of the power inductor as shown in the Typical Application drawing.
3	EN	Enable input. A logic high enables the AAT2215 regulator. A logic low forces the AAT2215 into shut-down mode, placing the output into a high-impedance state (true load disconnect) and reducing the quiescent current to less than 1 μ A.
4	IN	Input supply. IN powers the analog control circuitry during start-up. Bypass IN to GND with a 10 μ F or greater ceramic capacitor.
5	$\overline{\text{RDY}}$	Power ready signal (active low). RDY is an open-drain, active-low output. $\overline{\text{RDY}}$ is pulled low when the feedback voltage exceeds 95% of the target voltage.
6	AGND	Analog ground. AGND is internally connected to the analog ground of the control circuitry.
7	FB	Feedback input. FB senses the output voltage for regulation control. For adjustable output versions, connect a resistive divider network from the output to FB to GND to set the output voltage accordingly. The FB regulation threshold is 0.6V.
8	RSET	Programmable current-limit control. Connect an external resistor between RSET and AGND to set the peak NMOS current-limit threshold. The current-limit threshold may be adjusted from 0.6A to 4.0A. ⁹
9, 10	OUT	Output of step-up regulator. OUT internally connects to the synchronous high-side P-channel MOSFET.
11, 12	PGND	Power ground. PGND is internally connected to the source of the low-side N-channel MOSFET.
EP	Exposed Pad	Substrate/thermal ground. The exposed pad is internally connected to the substrate of the controller, and provides the lowest thermal impedance between the regulator and the PCB. Connect the exposed pad directly to the ground plane to reduce thermal stress.

Pin Configuration

TDFN33-12
(Top View)

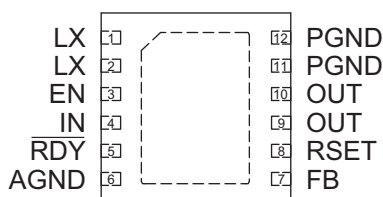

AAT2215

High Current Synchronous Step-Up Regulator with Programmable Current Limit

Absolute Maximum Ratings¹

Symbol	Description	Value	Units
V_{IN}	IN to PGND	-0.3 to 6	V
V_{OUT}, V_{LX}	OUT, LX to PGND ²	-0.3 to 6	
V_{EN}	EN to AGND	-0.3 to 6	
V_{FB}	FB to AGND	-0.3 to 6	
V_{RDY}	RDY to AGND	-0.3 to 6	
V_{GND}	AGND to PGND	-0.3 to 0.3	
T_J	Junction Temperature Range	-40 to 150	°C
T_S	Storage Temperature Range	-65 to 150	
T_{LEAD}	Maximum Soldering Temperature (at leads, 10 sec.)	300	

Thermal Characteristics³

Symbol	Description	Value	Units
TDFN33-12 Thermal Impedance			
θ_{JA}	Maximum Junction-to-Ambient Thermal Resistance	50	°C/W
P_D	Maximum Power Dissipation ⁴	2	W

Operating Characteristics

Symbol	Description	Value	Units
T_A	Operating Ambient Temperature Range	-40 to 85	°C
V_{IN}	Input Voltage Range	2.4 to $V_{OUT} + 0.25$	V
V_{OUT}	Output Voltage Range	3.0 to 5.5	

1. Stresses above those listed in Absolute Maximum Ratings may cause permanent damage to the device. Functional operation at conditions other than the operating conditions specified is not implied.
2. The P-channel between LX and OUT that changes the substrate connection to control the body diode. This allows the high-side diode when the regulator is active, but allows the output to be isolated from the input during shutdown (true load disconnect).
3. Mounted on 1.6mm thick FR4 board.
4. Derate 25mW/°C above 25°C.

High Current Synchronous Step-Up Regulator with Programmable Current Limit

Electrical Characteristics

$V_{IN} = 3.3V$, $V_{OUT} = 3.8V$, $AGND = PGND$. $T_A = +25^\circ C$, unless otherwise noted.

Symbol	Description	Conditions	Min	Typ	Max	Units
V_{IN}	Input Voltage Range		2.4		$V_{OUT} + 0.25$	V
$V_{IN(MIN)}$	Minimum Start-Up Voltage			2.3	2.4	
V_{OUT}	Output Voltage Range		3.0		5.5	
V_{UVLO}	Input Under-Voltage Lockout	V_{IN} Rising, Hysteresis = 0.1V	1.9	2.1	2.3	μA
I_Q	Supply Current with No Load	No Load Current; Not Switching		55	80	
I_{SHDN}	Shutdown Current	EN = GND, $V_{IN} = 5.5V$			1	V
V_{FB}	FB Accuracy	$T_A = 25^\circ C$, $I_{OUT} = 10mA$	0.588	0.60	0.612	
		$T_A = -40^\circ C$ to $85^\circ C$, $I_{OUT} = 10mA$	0.582	0.60	0.618	μA
I_{FB}	FB Leakage Current	$V_{FB} = 0$ to $1.0V$	-0.2		+0.2	
$\Delta V_{OUT}/I_{OUT}$	Load Regulation	$V_{IN} = 3.3V$, $V_{OUT} = 3.8V$, 0 to 2.5A Load		1		%/A
$\Delta V_{OUT}/V_{IN}$	Line Regulation	$V_{IN} = 2.4V$ to V_{OUT} , $I_{OUT} = 10mA$		0.3		%/V
V_{OVP}	OUT Over-Voltage Protection Threshold	Hysteresis = 200mV	5.6	6.0	6.4	V
f_{OSC}	Oscillator Frequency		480	600	720	kHz
D_{MAX}	Maximum Duty Cycle			90		%
$t_{ON(MIN)}$	Minimum On-Time			80		ns
$R_{ON(PMOS)}$	High-Side P-Channel On-Resistance			70		m Ω
$R_{ON(NMOS)}$	Low-Side N-Channel On-Resistance			90		
I_{STRT}	Input Start-Up PMOS Inrush Current Limit	$V_{OUT} + 0.5V < V_{IN}$, $R_{LOAD} = 1\Omega$	0.5	0.75		A
$I_{LIM(PMOS)}$	PMOS Linear Overload Current Limit	$V_{OUT} = 0V$		3.0		
		$R_{SET} = 75k\Omega$, $T_A = 25^\circ C$	2.625	3.5	4.375	
I_{LIMPK}	Low-Side Peak Current Limit Threshold	$R_{SET} = 63.4k\Omega$, $T_A = 25^\circ C$ $R_{SET} = 1000k\Omega$, $T_A = 25^\circ C$		4.0		
Enable, Power Ready and Start-Up Features						
$V_{EN(H)}$	Logic Input Threshold High for EN		1.4			V
$V_{EN(L)}$	Logic Input Threshold Low for EN				0.4	
I_{EN}	EN Input Current	$V_{EN} = GND$ or $5.5V$	-1.0		+1.0	μA
V_{RDY}	Power Ready Threshold	FB Rising, Hysteresis = 10%		95		%
R_{RDY}	RDY On-Resistance	$V_{FB} = 0.62V$, $I_{SINK} = 10\mu A$		2700		Ω
Thermal						
T_{SD}	Over-Temperature Shutdown Threshold	Temperature Rising		150		$^\circ C$
$T_{SD(HYS)}$	Over-Temperature Shutdown Hysteresis			15		

AAT2215

High Current Synchronous Step-Up Regulator with Programmable Current Limit

No Load Quiescent Current vs Input Voltage
(Close Loop, $V_{OUT} = 3.8V$)

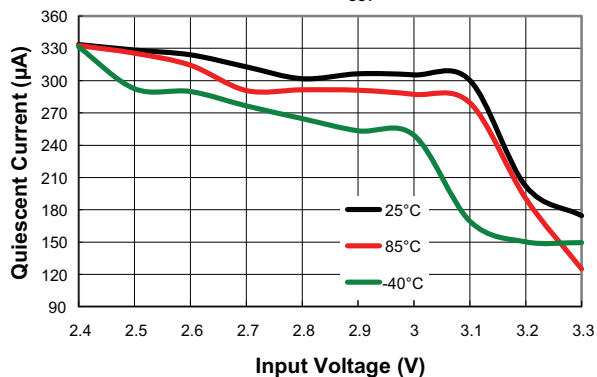

No Load Quiescent Current vs Temperature
(Close Loop, $V_{IN} = 3.3V$, $V_{OUT} = 3.8V$)

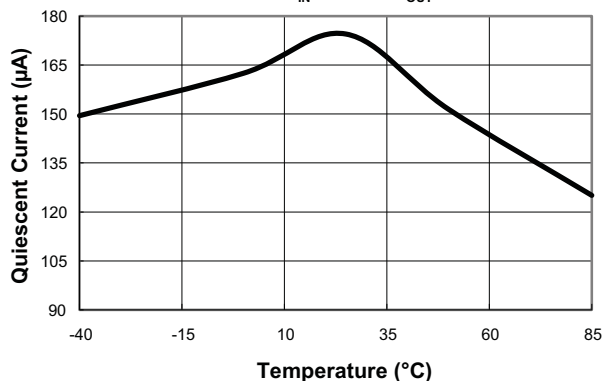

No Load Quiescent Current vs Input Voltage
(Open Loop)

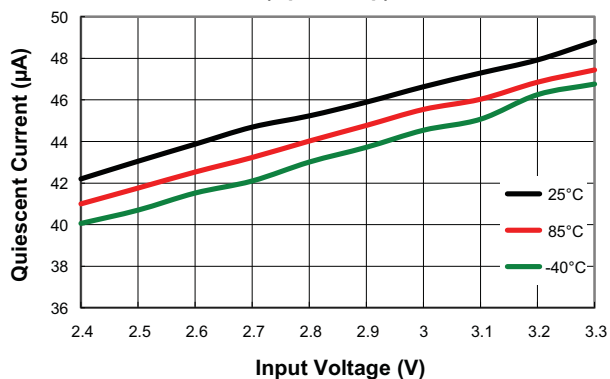

No Load Quiescent Current vs Temperature
(Open Loop, $V_{IN} = 3.3V$)

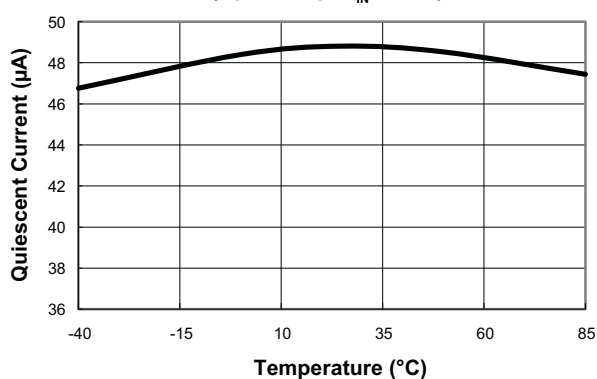

Frequency vs Temperature

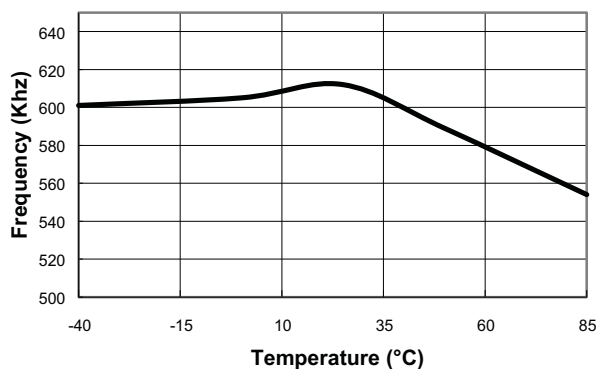

Enable Threshold vs Input Voltage

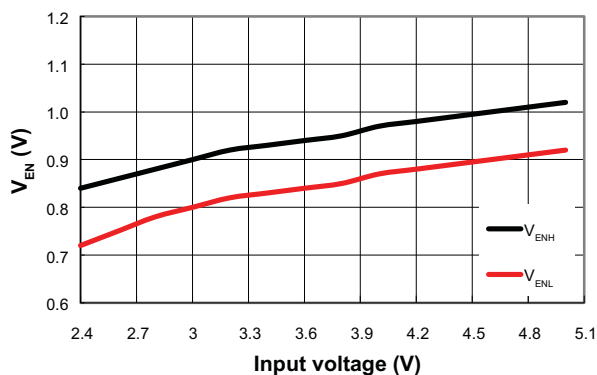

AAT2215

High Current Synchronous Step-Up Regulator with Programmable Current Limit

Enable Threshold vs Temperature

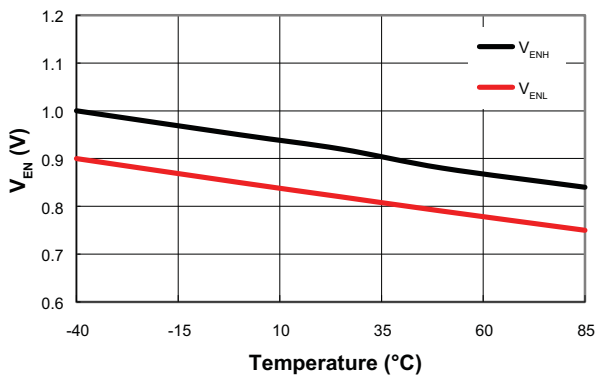

Feedback Voltage vs Input Voltage

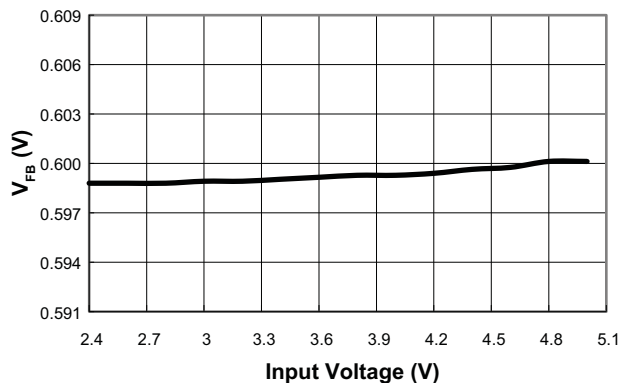

Feedback Voltage vs Temperature

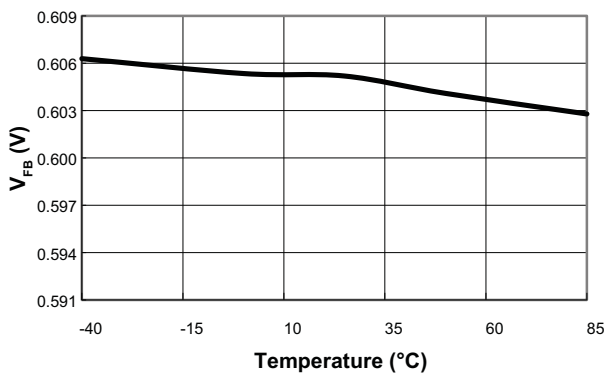

Efficiency
(L = 2.2μH, V_{OUT} = 3.8V)

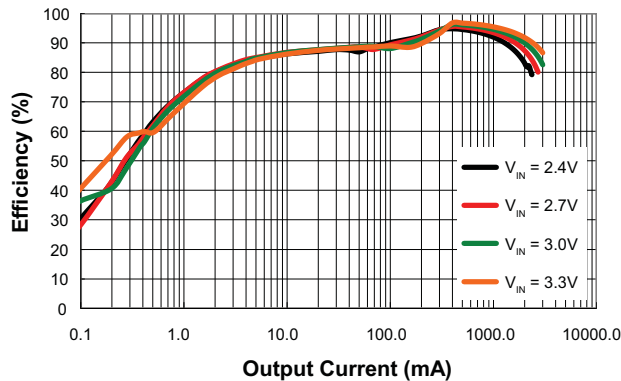

Efficiency
(L = 2.2μH, V_{OUT} = 5.0V)

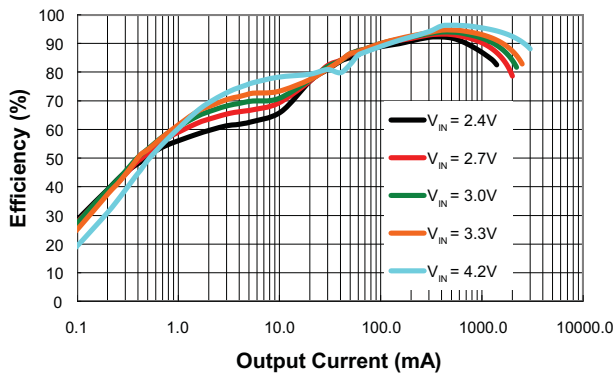

Load Regulation
(L = 2.2μH, V_{OUT} = 5.0V)

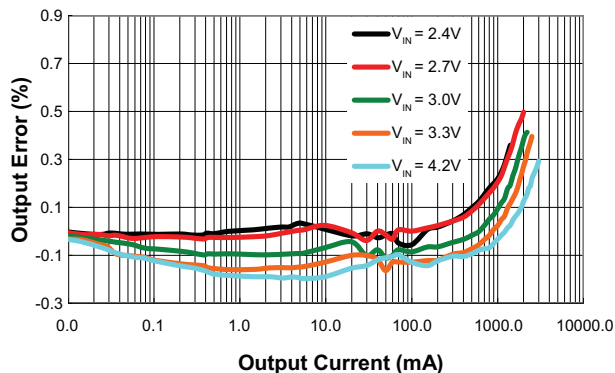

AAT2215

High Current Synchronous Step-Up Regulator with Programmable Current Limit

Load Regulation
(L = 2.2μH, V_{OUT} = 3.8V)

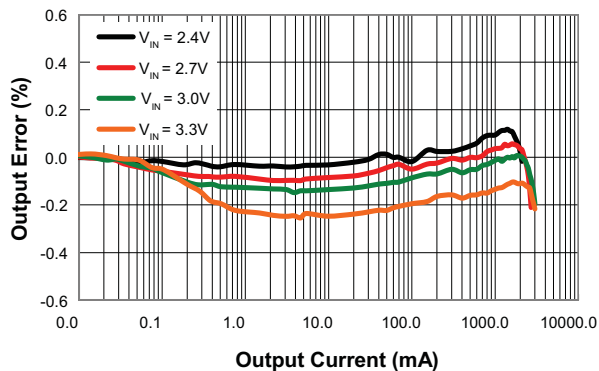

Line Regulation
(L = 2.2μH, V_{OUT} = 3.8V)

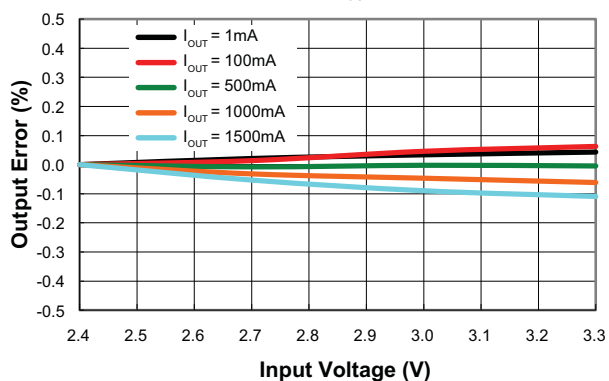

Soft Start
(V_{OUT} = 3.8V; V_{IN} = 3.3V; I_{OUT} = 0A)



Time (100μs/div)

Output Voltage Ripple
(V_{IN} = 3.3V; V_{OUT} = 3.8V; L = 2.2μH; I_{OUT} = 0mA)

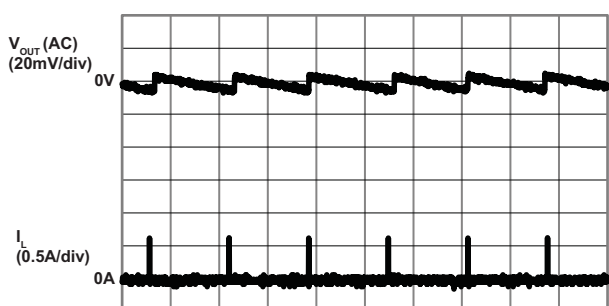

Time (400μs/div)

Output Voltage Ripple
(V_{IN} = 3.3V; V_{OUT} = 3.8V; L = 2.2μH; I_{OUT} = 1A)

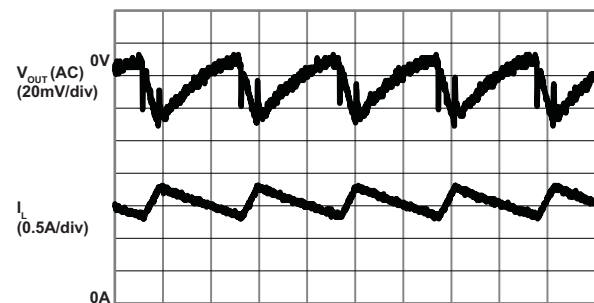

Time (800ns/div)

Output Voltage Ripple
(V_{IN} = 3.3V; V_{OUT} = 3.8V; L = 2.2μH; I_{OUT} = 2.5A)

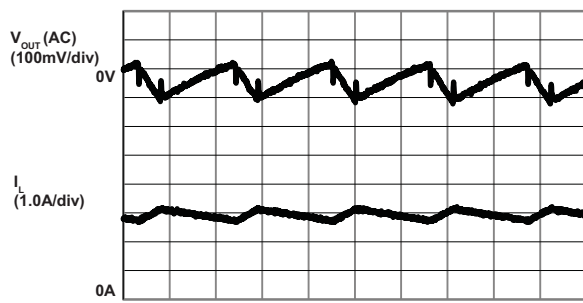

Time (800ns/div)

AAT2215

High Current Synchronous Step-Up Regulator with Programmable Current Limit

Load Transient

($V_{OUT} = 3.8V$; $V_{IN} = 3.3V$; $I_{OUT} = 100mA$ to $1.2A$;
 $L = 2.2\mu H$; $C_{OUT} = 22\mu F + 220\mu F$)

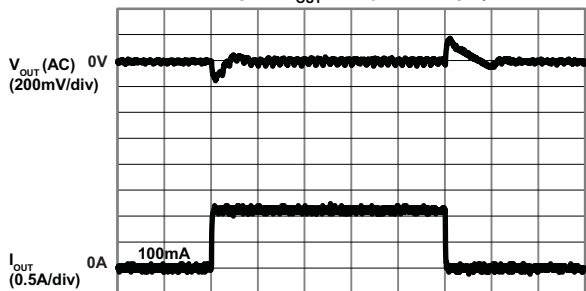

Time (400 μs /div)

Load Transient

($V_{OUT} = 3.8V$; $V_{IN} = 3.3V$; $L = 2.2\mu H$;
 $I_{OUT} = 100mA$ to $2.5A$; $C_{OUT} = 22\mu F + 220\mu F$)

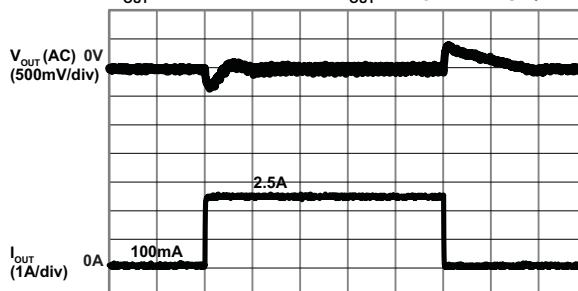

Time (400 μs /div)

Line Transient Response

($V_{IN} = 2.7V$ to $3.3V$; $V_{OUT} = 3.8V$; $L = 2.2\mu H$;
 $I_{OUT} = 100mA$; $C_{OUT} = 22\mu F$)

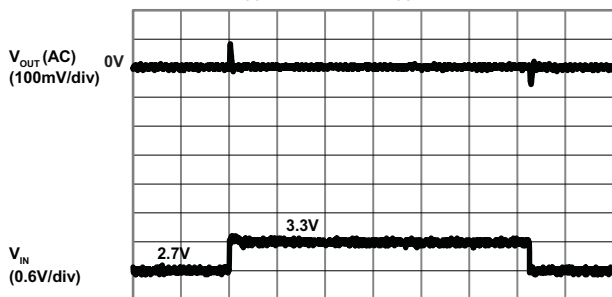

Time (400 μs /div)

AAT2215

High Current Synchronous Step-Up Regulator with Programmable Current Limit

Functional Block Diagram

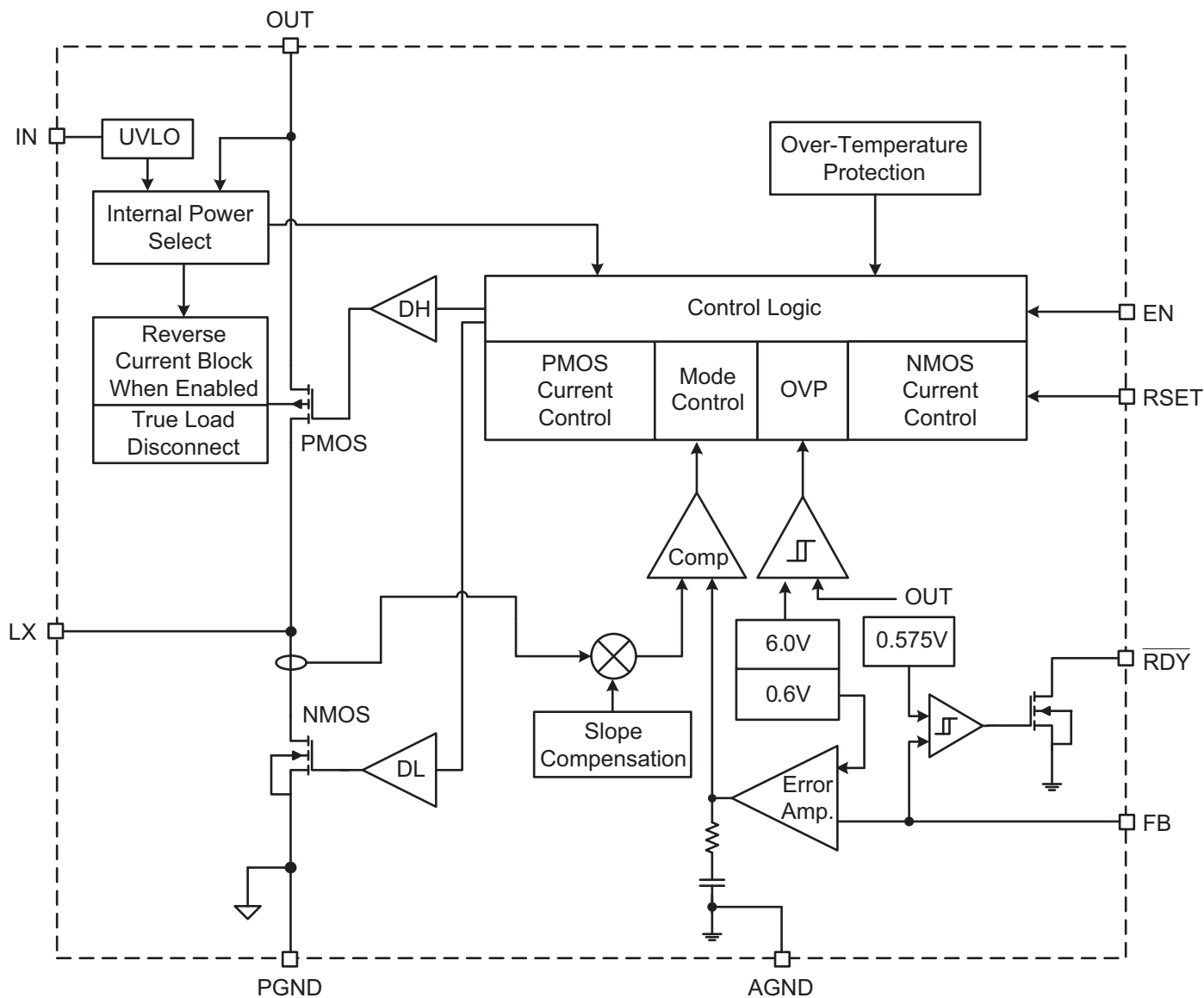

**High Current Synchronous Step-Up Regulator
with Programmable Current Limit****Functional Description**

The AAT2215 synchronous step-up converter is targeted for PC Card GSM/GPRS/3G and WiMax modem card applications. It includes a 0.75A start-up PMOS current limit to ensure fast, controlled power-up, a 3A overload PMOS current limit after startup, and a programmable peak NMOS step-up current limit up to 4A for continuous step-up operation within the PCMCIA specifications.

The 600kHz switching frequency of the AAT2215 facilitates output filter component size reduction for improved power density and reduced overall footprint. It also provides greater bandwidth and improved transient response over other lower frequency step-up converters. The compensation and feedback is integrated with only three external components (C_{IN} , C_{OUT} , L). Low $R_{DS(ON)}$ synchronous power switches provide high efficiency for heavy load conditions. Switching frequency modulation and low quiescent current maintains this high efficiency for light load mode condition. In addition to the improved efficiency, the synchronous step-up has the added performance advantage of true load disconnect during shutdown ($<1\mu\text{A}$ shutdown current), reverse current blocking when enabled, inrush current limit, and short-circuit protection.

**PWM Control Scheme
with Low-Noise Light-Load**

The AAT2215 is a fixed-frequency PWM peak current mode control step-up converter. For light load condition (70mA to 80mA and below), the converter stays in a variable frequency (Light Load) mode to reduce the dominant switching losses. In addition to Light Load operation, a zero current comparator blocks reverse current in the P-channel synchronous MOSFET, forcing DCM operation at light load. These controls, along with very low quiescent current, help to maintain high efficiency over the complete load range without increased output voltage ripple during light load conditions.

Shutdown and True Load Disconnect

A typical synchronous step-up (step-up) converter has a conduction path from the input to the output via the parasitic body diode of the P-channel MOSFET when the converter shuts down. The AAT2215 design a special power selection for the substrate to keep the parasitic body diode in off-state during shutdown and startup. This enables the AAT2215 to provide true load disconnect during shutdown and PMOS inrush current limit at startup.

During the initial PMOS linear mode start-up period, the start-up control circuitry is powered by the input supply pin. When the output voltage of the AAT2215 enters step-up mode ($V_{IN} \approx V_{OUT}$), the step-up control circuitry draws power directly from the output supply to ensure sufficient voltage head-room.

When EN is set to logic low, the step-up converter is forced into shutdown state with less than $1\mu\text{A}$ input current.

**Soft-start and PMOS
Current Limit Protection****Start-Up Inrush Current Protection**

When initially powering up, the load disconnect feature allows the output voltage to be less than the input voltage. In order to avoid large surge current when the regulator is enabled, the AAT2215 operates the synchronous P-channel MOSFET in a current-limited linear mode to softly charge the large output capacitor. This linear start-up feature effectively limits the input current to 0.75A until the output voltage exceeds the input voltage. After V_{OUT} exceeds V_{IN} , the regulator switches the body diode connection and begins step-up operation.

Overload Current-Limit Protection

Once start-up is completed, ($\overline{\text{RDY}}$ is pulled low), the AAT2215 increases the PMOS overload current-limit threshold to 3A. If the output is overloaded, causing V_{OUT} to drop below V_{IN} by 210mV, the regulator will switch back to a linear operating mode. This activates the 3A PMOS overload current protection and the AAT2215 will reverse the body-diode connection. This effectively limits the output current under such fault conditions.

Combined with the thermal shutdown protection, the PMOS current-limit protects the regulator against overload and short-circuit fault conditions.

The overload current limit is fixed at 3A, and short-circuit protection also adopts this 3A current limit; the 3A current limit is not changed with R_{SET} value.

Programmable Peak NMOS Current-Limit

When the output voltage of the AAT2215 enters step-up mode ($V_{IN} < V_{OUT}$), the NMOS starts switching and the NMOS peak current-limit becomes active. During the inductor charge cycle, the low-side NMOS turns on and the AAT2215 monitors the current through the NMOS. If the current exceeds the current-limit threshold set by

**High Current Synchronous Step-Up Regulator
with Programmable Current Limit**

the R_{SET} resistor, the regulator immediately turns off the low-side NMOS. The regulator limits the instantaneous peak inductor/NMOS current, so the current-limit threshold must be set high enough to support the desired output current.

Power Ready

To indicate the output voltage is in regulation, an active-low open-drain output pin (\overline{RDY}) pulls down when the feedback voltage is above 95% of the nominal regulation voltage level. \overline{RDY} becomes a high-impedance output if the feedback voltage drops below 85% of the nominal regulation voltage level.

Over-Voltage Protection

The AAT2215's over-voltage protection function prevents the output voltage from exceeding the fixed 6V (typ) over-voltage point, which would exceed the absolute maximum rating of the regulator. If OUT exceeds 6V, the regulator will stop switching until the output voltage drops below 5.8V (200mV hysteresis) and FB is below its regulation threshold.

Thermal Shutdown

When the junction temperature exceeds the over-temperature threshold, the AAT2215 thermal protection circuitry shuts down the regulator. Thermal shutdown disables switching and PMOS current limit is functional to control the current flowing through to avoid any damage of the step-up converter. When the over-temperature fault condition is removed, the step-up recovers regulation automatically.

Application Information **R_{SET} Selection for Programmable Current Limit**

The current limit of the internal low-side NMOS power switch is programmable from 0.6A to 4.0A by an external resistor connected from RSET to ground.

When the inductor's peak current reaches the current limit, the \overline{RDY} indicator is pulled high. Table 1 gives standard 1% standard metal film resistor example values for the peak NMOS current-limit programming.

R_{SET} (k Ω)	I_{LIMIT} (A)
63.4	4
75.0	3.48
82.0	3.1
100.0	2.6
118.0	2.15
150.0	1.75
180.0	1.52
300.0	1.02
432.0	0.82
1000.0	0.6

Table 1: Examples of 1% Standard Resistor Value of R_{SET}

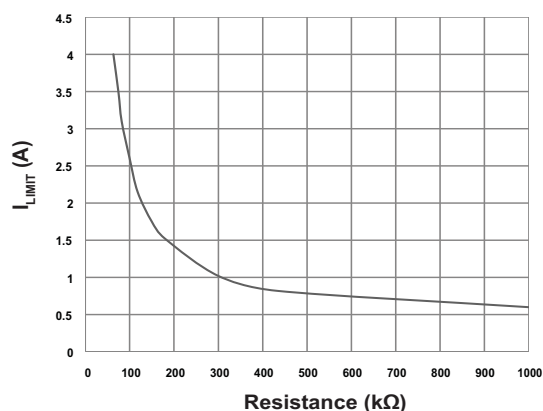

Figure 1: I_{LIMIT} vs R_{SET}

High Current Synchronous Step-Up Regulator with Programmable Current Limit

Output Voltage Programming

The output voltage of the AAT2215 may be programmed from 3.0V to 5.5V with an external resistive voltage divider. Resistors R1 and R2 in Figure 1 program the output voltage as shown by the following equation:

$$R1 = \left(\frac{V_{OUT}}{V_{REF}} - 1 \right) \cdot R2$$

where 0.6V is the feedback reference voltage (V_{REF}). To limit the bias current required for the external feedback resistor string while maintaining good noise immunity, the suggested value for R2 is 100k Ω . Table 2 summarizes the resistor values with R2 set to 100k Ω for good noise immunity and 6 μ A increased load current and gives some 1% standard metal film resistor values for R1 at different output voltage settings.

$V_{OUT}(V)$	R2 = 100k Ω R1 = (k Ω)
3	400
3.3	450
3.6	500
3.8	536
4.2	600
4.5	650
5	733
5.5	816

Table 2: Resistor Selection for Output Voltage

Inductor Selection

The AAT2215 is designed to operate with a 2.2 μ H inductor for all input/output voltage combinations. For high efficiency, choose a ferrite inductor with a high frequency core material to reduce core losses. The inductor should have low ESR (equivalent series resistance) to reduce the I^2R losses, and must be able to handle the peak inductor current without saturating. To minimize radiated noise, use a shielded inductor.

Input Capacitor

Select a low ESR ceramic capacitor with a value of at least 10 μ F as the input capacitor. Place the input capacitor as close to the IN and PGND pins as possible in order to minimize the stray resistance from the converter to the input power source.

Output Capacitor

The output capacitor provides energy to the load when the high-side MOSFET is switched off. The output capacitance together with the boost switching frequency, duty cycle, and load current value determine the capacitive output voltage ripple when the boost operation is in the continuous PWM state.

$$\Delta V_{OUT} = \left(\frac{I_{OUT} \cdot D}{C_{OUT} \cdot f_{SW}} \right)$$

where D is the duty ratio of low-side MOSFET turn-on time divided by the switching period. It is calculated using the equation:

$$D = 1 - \left(\frac{V_{IN}}{V_{OUT}} \right)$$

The output capacitor's ESR increases the output ripple by $I_{OUT} \cdot ESR$. The total output ripple is:

$$\Delta V_{OUT} = (I_{OUT} \cdot ESR) + \left(\frac{I_{OUT} \cdot D}{C_{OUT} \cdot f_{SW}} \right)$$

So the minimum recommended output capacitor value may be determined by:

$$C_{OUT} \geq \left(\frac{I_{OUT} \cdot D}{\Delta V_{OUT} - (I_{OUT} \cdot ESR)} \right) \cdot \frac{1}{f_{SW}}$$

High Current Synchronous Step-Up Regulator with Programmable Current Limit

High Load Pulse Application

Together with a large value output capacitor or supercap, the AAT2215 can support a higher load pulse in lower input current limited applications such as GSM burst mode in WCDMA, Edge, GPRS and TD-SCDMA applications. The large capacitance is determined by NMOS peak current limit, inductor current ripple, V_{IN} , V_{OUT} , load pulse high current level and elapsed time. The capacitor value can be calculated using the following three steps as follows:

First calculate the AAT2215's load-on current from the expected I_{LIM} . Assume the input current equals I_{LIM} because the inductor current ripple is low enough when compared to the input current:

$$I_{OUT_BOOST} = \frac{V_{IN} \cdot I_{LIM} \cdot \eta}{V_{OUT}}$$

Second, calculate the maximum current the large capacitor C_{OUT} should provide:

$$I_{COUT} = I_{LOAD_PEAK} - I_{OUT_BOOST}$$

Finally, derive the C_{OUT} at a certain load-on period T_{ON} :

$$C_{OUT} = \frac{I_{COUT} \cdot T_{ON}}{\Delta V_{OUT}}$$

To consider the real tantalum capacitor having 20% tolerance, the selected capacitance should be 20% higher than the calculated value. Example: A 2.0A, 217Hz 12.5% duty cycle load pulse is applied on 3.8V V_{OUT} at 3.3V V_{IN} . An input peak current limit of 2.4A and a V_{OUT} drop of less than 450mV are required. Under these conditions, with 89% efficiency, the AAT2215's output current is

$$I_{OUT_BOOST} = \frac{3.3 \cdot 2.4 \cdot 89\%}{3.8} = 1.86A$$

The maximum current necessary for the large capacitor value is:

$$I_{COUT} = 2.0 - 1.86 = 0.14A$$

T_{ON} is 577 μ s for a 217Hz 12.5% duty cycle load pulse. Considering 20% capacitance tolerance, the minimum capacitance should be 220 μ F. Figure 2 shows the AAT2215 operating waveform under a 2.0A 577 μ s load pulse with 220 μ F tantalum capacitor as C_{OUT} , as well as a 22 μ F ceramic capacitor to closely filter the output voltage.

Load Pulse Response

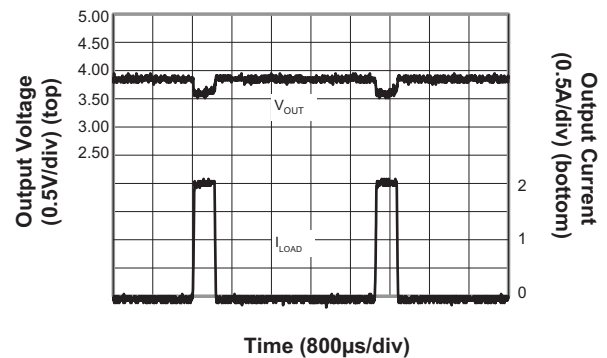

Figure 2: AAT2215 Operation Waveform When 2.0A 217Hz 577 μ s Load Pulse is Applied.

Layout Guidance

For best performance of the AAT2215, the following guidelines should be followed when designing the PCB layout:

1. Make the power trace as short and wide as possible, including the input/output power lines and switching node, etc.
2. Connect the analog and power grounds together with a single short line and connect all low current loop grounds to analog ground to decrease the power ground noise on the analog ground and achieve better load regulation.
3. For good power dissipation, connect the exposed pad under the package to the top and bottom ground planes by PCB pads.

AAT2215**High Current Synchronous Step-Up Regulator
with Programmable Current Limit**

Part Number	Inductance (μH)	Max DC Current (A)	DCR ($\text{m}\Omega$)	Size LxWxH (mm)	Type
CHRH103RNP-2R2NC	2.2	6.7	20	10x10x2.8	Shielded
CDRH103RNP-3R3NC	3.3	5.5	21	10x10x2.8	Shielded
7440650033	3.3	4.7	20	10x10x2.8	Shielded
LQH6PPN3R3N43	3.3	4.5	16	6x6x4.3	Shielded

Table 3: Surface Mount Inductors.

Part Number	Description	Manufacturer
AAT2215IWP-0.6	High Current Step-Up Converter with Adjustable Current Limit	Skyworks
RC0603FR-07536KL	Res 536k Ω 1/10W 1% 0603 SMD	Yageo
RC0603FR-07100KL	Res 100k Ω 1/10W 1% 0603 SMD	
RC0603FR-07100KL	Res 100k Ω 1/10W 1% 0603 SMD	
RC0603FR-07100KL	Res 100k Ω 1/10W 1% 0603 SMD	
GRM21BR61C106K	Cap Ceramic 10 μF 0805 X5R 16V 10%	Murata
GRM21BR60J226M	Cap Ceramic 22 μF 0805 X5R 6.3V 20%	
TPSY227M006R0150	Cap Tan 220 μF case 6.3V 20%	AVX
CDRH103RNP-2R2NC	Inductor 2.2 μH 6.7A SMD	Sumida

Table 4: AAT2215 Evaluation Board Bill of Materials.

**High Current Synchronous Step-Up Regulator
with Programmable Current Limit****Ordering Information**

Package	Marking ¹	Part Number (Tape and Reel) ²
TDFN33-12	P5XYY	AAT2215IWP -T1



Skyworks Green™ products are compliant with all applicable legislation and are halogen-free.

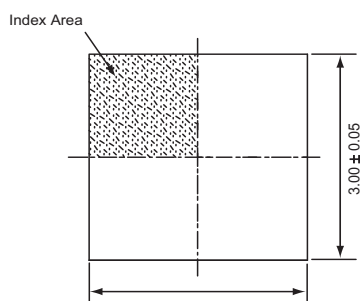

For additional information, refer to *Skyworks Definition of Green™*, document number SQ04-0074.

Package Information³**TDFN33-12**

Top View

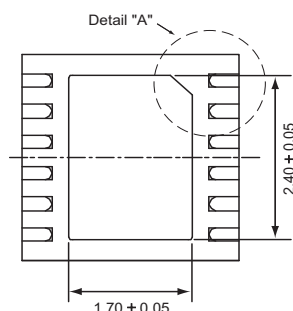

Bottom View

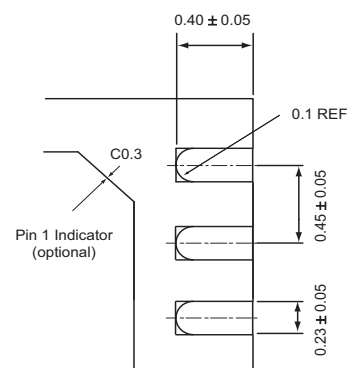

Detail "A"

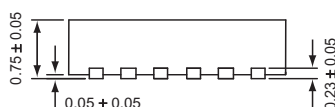

Side View

All dimensions in millimeters.

1. XYY = assembly and date code.
2. Sample stock is generally held on part numbers listed in **BOLD**.
3. The leadless package family, which includes QFN, TQFN, DFN, TDFN and STDFN, has exposed copper (unplated) at the end of the lead terminals due to the manufacturing process. A solder fillet at the exposed copper edge cannot be guaranteed and is not required to ensure a proper bottom solder connection.

**High Current Synchronous Step-Up Regulator
with Programmable Current Limit**

Copyright © 2012 Skyworks Solutions, Inc. All Rights Reserved.

Information in this document is provided in connection with Skyworks Solutions, Inc. ("Skyworks") products or services. These materials, including the information contained herein, are provided by Skyworks as a service to its customers and may be used for informational purposes only by the customer. Skyworks assumes no responsibility for errors or omissions in these materials or the information contained herein. Skyworks may change its documentation, products, services, specifications or product descriptions at any time, without notice. Skyworks makes no commitment to update the materials or information and shall have no responsibility whatsoever for conflicts, incompatibilities, or other difficulties arising from any future changes.

No license, whether express, implied, by estoppel or otherwise, is granted to any intellectual property rights by this document. Skyworks assumes no liability for any materials, products or information provided hereunder, including the sale, distribution, reproduction or use of Skyworks products, information or materials, except as may be provided in Skyworks Terms and Conditions of Sale.

THE MATERIALS, PRODUCTS AND INFORMATION ARE PROVIDED "AS IS" WITHOUT WARRANTY OF ANY KIND, WHETHER EXPRESS, IMPLIED, STATUTORY, OR OTHERWISE, INCLUDING FITNESS FOR A PARTICULAR PURPOSE OR USE, MERCHANTABILITY, PERFORMANCE, QUALITY OR NON-INFRINGEMENT OF ANY INTELLECTUAL PROPERTY RIGHT; ALL SUCH WARRANTIES ARE HEREBY EXPRESSLY DISCLAIMED. SKYWORKS DOES NOT WARRANT THE ACCURACY OR COMPLETENESS OF THE INFORMATION, TEXT, GRAPHICS OR OTHER ITEMS CONTAINED WITHIN THESE MATERIALS. SKYWORKS SHALL NOT BE LIABLE FOR ANY DAMAGES, INCLUDING BUT NOT LIMITED TO ANY SPECIAL, INDIRECT, INCIDENTAL, STATUTORY, OR CONSEQUENTIAL DAMAGES, INCLUDING WITHOUT LIMITATION, LOST REVENUES OR LOST PROFITS THAT MAY RESULT FROM THE USE OF THE MATERIALS OR INFORMATION, WHETHER OR NOT THE RECIPIENT OF MATERIALS HAS BEEN ADVISED OF THE POSSIBILITY OF SUCH DAMAGE.

Skyworks products are not intended for use in medical, lifesaving or life-sustaining applications, or other equipment in which the failure of the Skyworks products could lead to personal injury, death, physical or environmental damage. Skyworks customers using or selling Skyworks products for use in such applications do so at their own risk and agree to fully indemnify Skyworks for any damages resulting from such improper use or sale.

Customers are responsible for their products and applications using Skyworks products, which may deviate from published specifications as a result of design defects, errors, or operation of products outside of published parameters or design specifications. Customers should include design and operating safeguards to minimize these and other risks. Skyworks assumes no liability for applications assistance, customer product design, or damage to any equipment resulting from the use of Skyworks products outside of stated published specifications or parameters.

Skyworks, the Skyworks symbol, and "Breakthrough Simplicity" are trademarks or registered trademarks of Skyworks Solutions, Inc., in the United States and other countries. Third-party brands and names are for identification purposes only, and are the property of their respective owners. Additional information, including relevant terms and conditions, posted at www.skyworksinc.com, are incorporated by reference.



Компания «ЭлектроПласт» предлагает заключение долгосрочных отношений при поставках импортных электронных компонентов на взаимовыгодных условиях!

Наши преимущества:

- Оперативные поставки широкого спектра электронных компонентов отечественного и импортного производства напрямую от производителей и с крупнейших мировых складов;
- Поставка более 17-ти миллионов наименований электронных компонентов;
- Поставка сложных, дефицитных, либо снятых с производства позиций;
- Оперативные сроки поставки под заказ (от 5 рабочих дней);
- Экспресс доставка в любую точку России;
- Техническая поддержка проекта, помощь в подборе аналогов, поставка прототипов;
- Система менеджмента качества сертифицирована по Международному стандарту ISO 9001;
- Лицензия ФСБ на осуществление работ с использованием сведений, составляющих государственную тайну;
- Поставка специализированных компонентов (Xilinx, Altera, Analog Devices, Intersil, Interpoint, Microsemi, Aeroflex, Peregrine, Syfer, Eurofarad, Texas Instrument, Miteq, Cobham, E2V, MA-COM, Hittite, Mini-Circuits, General Dynamics и др.);

Помимо этого, одним из направлений компании «ЭлектроПласт» является направление «Источники питания». Мы предлагаем Вам помощь Конструкторского отдела:

- Подбор оптимального решения, техническое обоснование при выборе компонента;
- Подбор аналогов;
- Консультации по применению компонента;
- Поставка образцов и прототипов;
- Техническая поддержка проекта;
- Защита от снятия компонента с производства.



Как с нами связаться

Телефон: 8 (812) 309 58 32 (многоканальный)

Факс: 8 (812) 320-02-42

Электронная почта: org@eplast1.ru

Адрес: 198099, г. Санкт-Петербург, ул. Калинина, дом 2, корпус 4, литера А.