

LOW NOISE 150mA LDO REGULATOR R1111N SERIES

OUTLINE

The R1111N Series are voltage regulator ICs with high output voltage accuracy, extremely low supply current, low ON-resistance, and high Ripple Rejection by CMOS process. Each of these voltage regulator ICs consists of a voltage reference unit, an error amplifier, resistors, a current limit circuit, and a chip enable circuit.

These ICs perform with low dropout voltage and a chip enable function. The line transient response and load transient response of the R1111N Series are excellent, thus these ICs are very suitable for the power supply for hand-held communication equipment.

The output voltage of these ICs is fixed with high accuracy. Since the package for these ICs are SOT-23-5 (Mini-mold) package, high density mounting of the ICs on boards is possible.

FEATURES

- Ultra-Low Supply Current.....TYP. 35 μ A
- Standby ModeTYP. 0.1 μ A
- Low Dropout VoltageTYP. 0.2V($I_{OUT}=100mA$)
- High Ripple RejectionTYP. 70dB($f=1kHz$)
- Low Temperature-Drift Coefficient of
- Output Voltage.....TYP. $\pm 100ppm/^{\circ}C$
- Excellent Line RegulationTYP. 0.05%/V
- High Output Voltage Accuracy..... $\pm 2.0\%$
- Excellent Line Transient Response and Load Transient Response
- Small PackageSOT-23-5(Mini-mold)
- Output Voltage.....Stepwise setting with a step of 0.1V in the range of 1.5V to 5.0V is possible
- Built-in chip enable circuit (2 types; A: "L" active, B: "H" active)
- PinoutSimilar to the LP2980

APPLICATIONS

- Power source for cellular phones such as GSM, CDMA and various kind of PCSs.
- Power source for electrical appliances such as cameras, VCRs and camcorders.
- Power source for battery-powered equipment.

BLOCK DIAGRAM

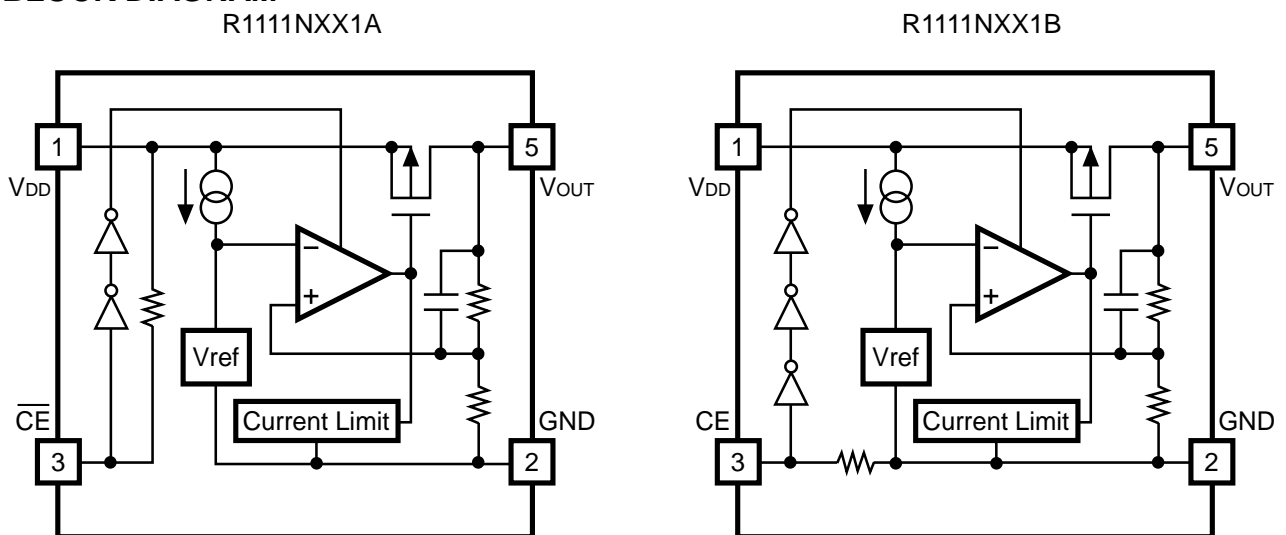

SELECTION GUIDE

The output voltage, the active type, the packing type, and the taping type for the ICs can be selected at the user's request. The selection can be made by designating the part number as shown below :

R1111XXX1X-XX ←Part Number
 ↑ ↑ ↑ ↑
 a b c d

Code	Contents
a	Designation of Package Type : N:SOT-23-5 (Mini-mold)
b	Setting Output Voltage (V _{OUT}) : Stepwise setting with a step of 0.1V in the range of 1.5V to 5.0V is possible.
c	Designation of Active Type : A :“L” active type B :“H” active type
d	Designation of Taping Type : Ex. TR, TL (refer to Taping Specifications ;TR type is the standard direction.)

PIN CONFIGURATION



PIN DESCRIPTION

Pin No.	Symbol	Description
1	V _{DD}	Input Pin
2	GND	Ground Pin
3	$\overline{\text{CE}}$ or CE	Chip Enable Pin
4	NC	No Connection
5	V _{OUT}	Output pin

■ ABSOLUTE MAXIMUM RATINGS

Item	Symbol	Rating	Unit
Input Voltage	V_{IN}	9	V
Input Voltage(\overline{CE} or CE Pin)	V_{CE}	-0.3 ~ $V_{IN}+0.3$	V
Output Voltage	V_{OUT}	-0.3 ~ $V_{IN}+0.3$	V
Power Dissipation	P_D	250	mW
Operating Temperature Range	T_{opt}	-40 ~ 85	°C
Storage Temperature Range	T_{stg}	-55 ~ 125	°C

■ ELECTRICAL CHARACTERISTICS

● R1111NXX1A

$T_{opt}=25^{\circ}\text{C}$

Symbol	Item	Conditions	MIN.	TYP.	MAX.	Unit
V_{OUT}	Output Voltage	$V_{IN} = \text{Set } V_{OUT}+1\text{V}$ $1\text{mA} \leq I_{OUT} \leq 30\text{mA}$	V_{OUT} $\times 0.98$		V_{OUT} $\times 1.02$	V
I_{OUT}	Output Current	Refer to the ELECTRICAL CHARACTERISTICS by OUTPUT VOLTAGE				
$\Delta V_{OUT}/\Delta I_{OUT}$	Load Regulation	$V_{IN} = \text{Set } V_{OUT}+1\text{V}$ $1\text{mA} \leq I_{OUT} \leq 80\text{mA}$		12	40	mV
V_{DIF}	Dropout Voltage	Refer to the ELECTRICAL CHARACTERISTICS by OUTPUT VOLTAGE				
I_{SS}	Supply Current	$V_{IN} = \text{Set } V_{OUT}+1\text{V}$		35	70	μA
$I_{standby}$	Supply Current (Standby)	$V_{IN} = V_{CE} = \text{Set } V_{OUT}+1\text{V}$		0.1	1.0	μA
$\Delta V_{OUT}/\Delta V_{IN}$	Line Regulation	Set $V_{OUT}+0.5\text{V} \leq V_{IN} \leq 8\text{V}$ $I_{OUT} = 30\text{mA}$		0.05	0.20	%/V
RR	Ripple Rejection	$f = 1\text{KHz}$, Ripple 0.5Vp-p $V_{IN} = \text{Set } V_{OUT}+1\text{V}$		70		dB
V_{IN}	Input Voltage				8	V
$\Delta V_{OUT}/\Delta T$	Output Voltage Temperature Coefficient	$I_{OUT} = 30\text{mA}$ $-40^{\circ}\text{C} \leq T_{opt} \leq 85^{\circ}\text{C}$		± 100		ppm/ °C
I_{lim}	Short Current Limit	$V_{OUT} = 0\text{V}$		50		mA
R_{PU}	\overline{CE} Pull-up Resistance		2.5	5	10	$\text{M}\Omega$
V_{CEH}	\overline{CE} Input Voltage "H"		1.5		V_{IN}	V
V_{CEL}	\overline{CE} Input Voltage "L"		0		0.25	V
en	Output Noise	$\text{BW} = 10\text{Hz} \sim 100\text{kHz}$		30		μVrms

● R1111NXX1B

T_{opt}=25°C

Symbol	Item	Conditions	MIN.	TYP.	MAX.	Unit
V _{OUT}	Output Voltage	V _{IN} = Set V _{OUT} +1V 1mA ≤ I _{OUT} ≤ 30mA	V _{OUT} ×0.98		V _{OUT} ×1.02	V
I _{OUT}	Output Current	Refer to the ELECTRICAL CHARACTERISTICS by OUTPUT VOLTAGE				
ΔV _{OUT} /ΔI _{OUT}	Load Regulation	V _{IN} = Set V _{OUT} +1V 1mA ≤ I _{OUT} ≤ 80mA		12	40	mV
V _{DIF}	Dropout Voltage	Refer to the ELECTRICAL CHARACTERISTICS by OUTPUT VOLTAGE				
I _{SS}	Supply Current	V _{IN} = Set V _{OUT} +1V		35	70	μA
I _{standby}	Supply Current (Standby)	V _{IN} = Set V _{OUT} +1V V _{CE} =GND		0.1	1.0	μA
ΔV _{OUT} /ΔV _{IN}	Line Regulation	Set V _{OUT} +0.5V ≤ V _{IN} ≤ 8V I _{OUT} = 30mA		0.05	0.20	%/V
RR	Ripple Rejection	f = 1KHz, Ripple 0.5Vp-p V _{IN} = Set V _{OUT} +1V		70		dB
V _{IN}	Input Voltage				8	V
ΔV _{OUT} /ΔT	Output Voltage Temperature Coefficient	I _{OUT} = 30mA -40°C ≤ Top t ≤ 85°C		±100		ppm/°C
I _{lim}	Short Current Limit	V _{OUT} = 0V		50		mA
R _{PD}	CE Pull-down Resistance		2.5	5	10	MΩ
V _{CEH}	CE Input Voltage "H"		1.5		V _{IN}	V
V _{CEL}	CE Input Voltage "L"		0		0.25	V
en	Output Noise	BW = 10Hz ~ 100kHz		30		μVrms

● ELECTRICAL CHARACTERISTICS by OUTPUT VOLTAGE

T_{opt} = 25°C

Output Voltage	Output Current	
	I _{OUT} (mA)	
	Condition	MIN.
1.5 ≤ V _{OUT} ≤ 1.7	V _{IN} - V _{OUT} = 1.0V	100
1.8 ≤ V _{OUT} ≤ 5.0		150

T_{opt} = 25°C

Output Voltage V _{OUT} (V)	Dropout Voltage			
	V _{DIF} (V)			
	Condition	MIN.	TYP.	MAX.
1.5	I _{OUT} = 100mA	0.5		
1.6		0.4		
1.7		0.3		
1.8 ≤ V _{OUT} ≤ 1.9			0.60	1.40
2.0 ≤ V _{OUT} ≤ 2.4			0.35	0.70
2.5 ≤ V _{OUT} ≤ 2.7			0.24	0.35
2.8 ≤ V _{OUT} ≤ 3.3			0.20	0.30
3.4 ≤ V _{OUT} ≤ 5.0			0.17	0.26

■ OPERATION



In these ICs, fluctuation of Output Voltage, V_{OUT} is detected by Feed-back Registers R1, R2, and the result is compared with a reference voltage by Error Amplifier, so that a constant voltage is output. A current limit circuit for Protection at short mode and a chip enable circuit are included.

■ TEST CIRCUITS



Fig.1 Standard test Circuit

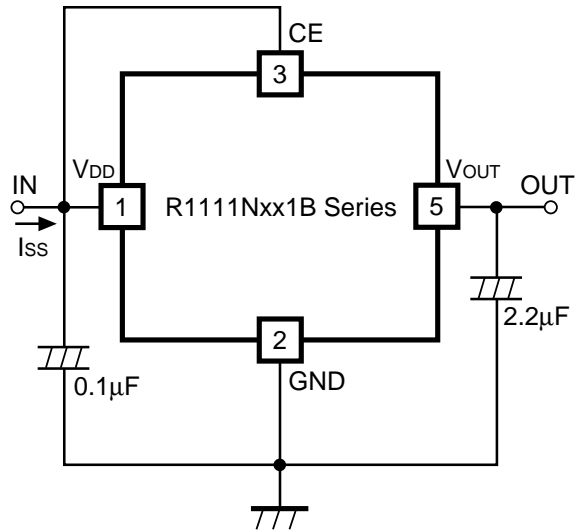

Fig.2 Supply Current Test Circuit



Fig.3 Ripple Rejection, Line Transient Response Test Circuit

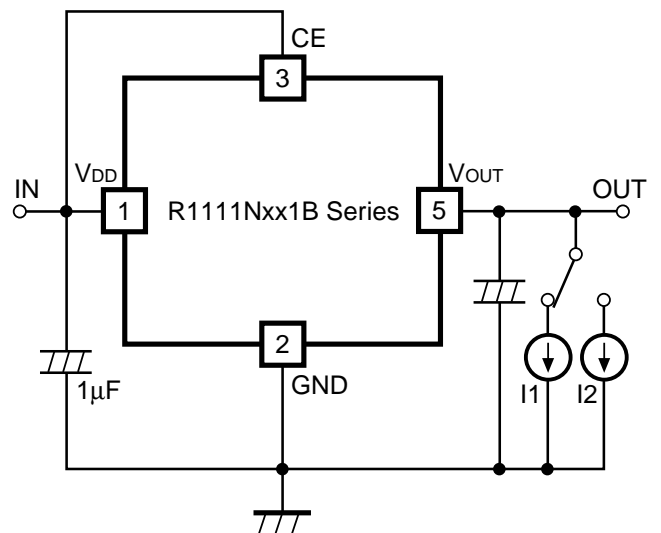
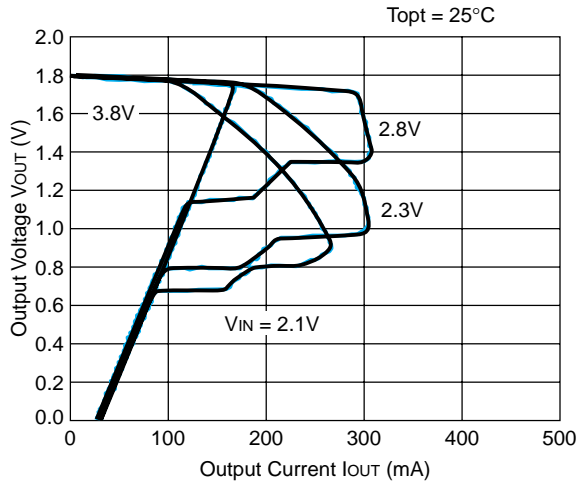

Fig.4 Load Transient Response Test Circuit

TYPICAL CHARACTERISTICS

1) Output Voltage vs. Output Current

R1111N181B



R1111N301B

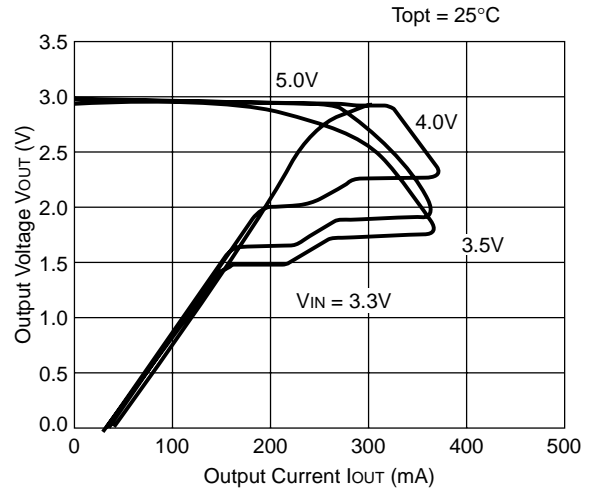

R1111N401B

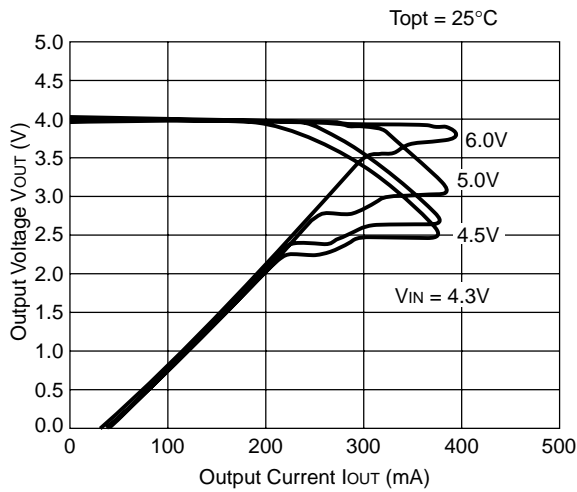

R1111N501B

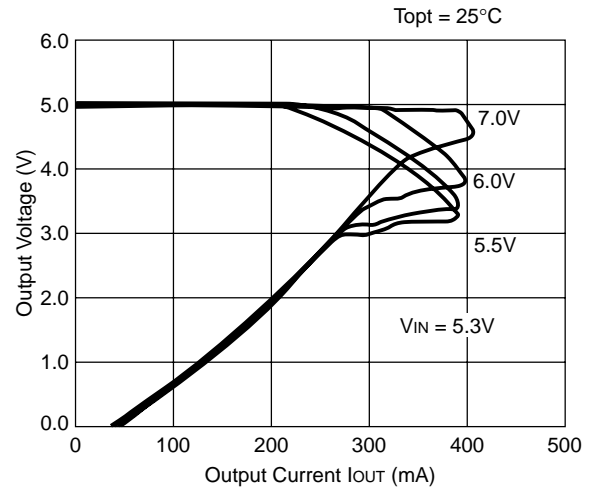

2) Output Voltage vs. Input Voltage

R1111N181B

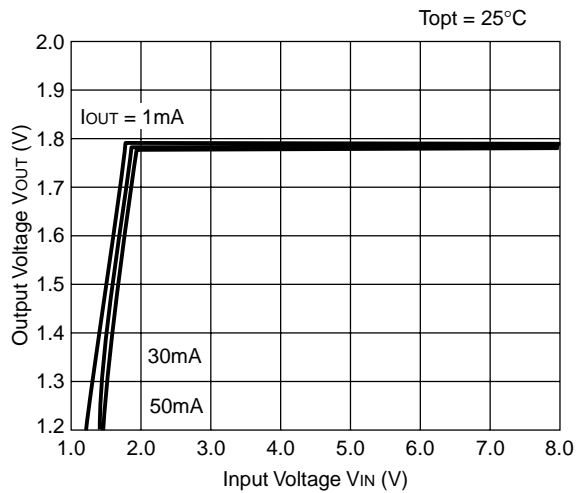

R1111N301B

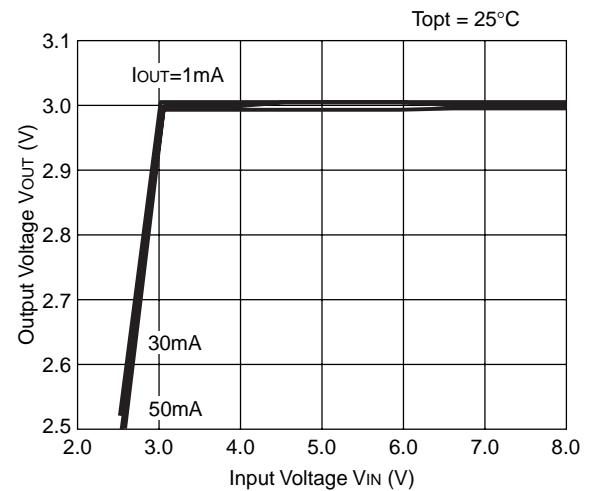

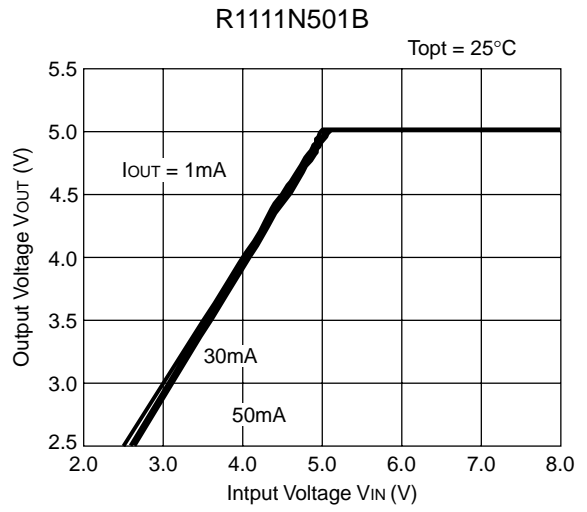

3) Dropout Voltage vs. Output Current

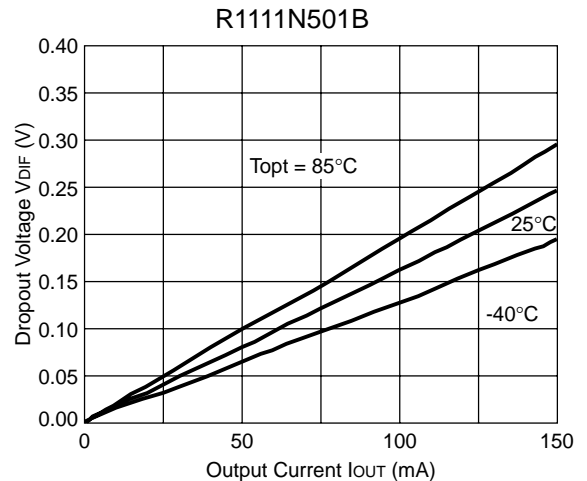
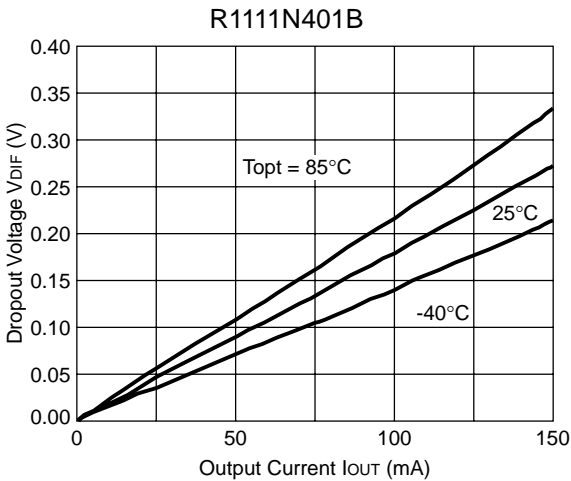
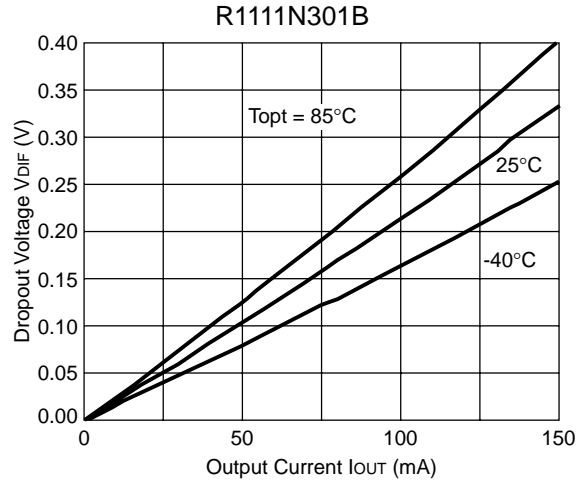
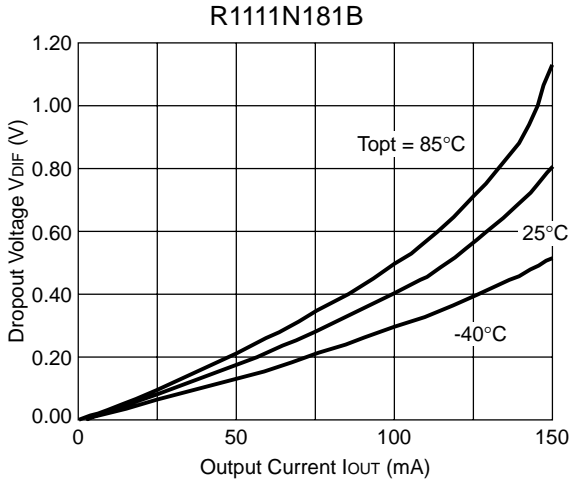

4) Output Voltage vs. Temperature
R1111N181B



R1111N301B

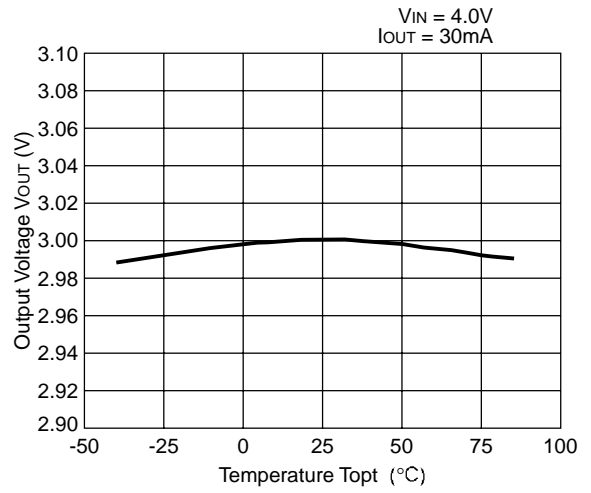

R1111N401B



R1111N501B

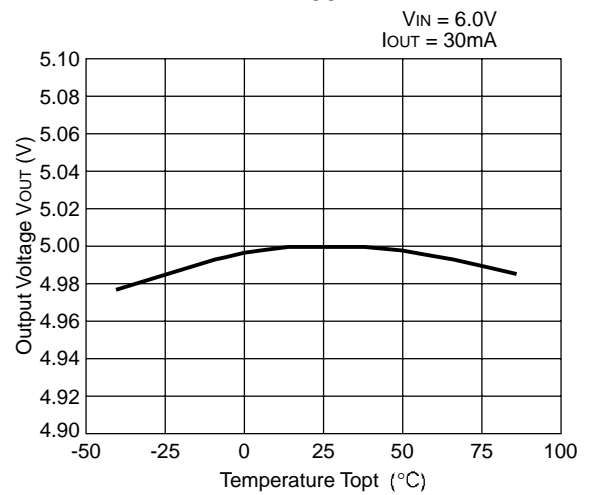

5) Supply Current vs. Input Voltage
R1111N181B



R1111N301B

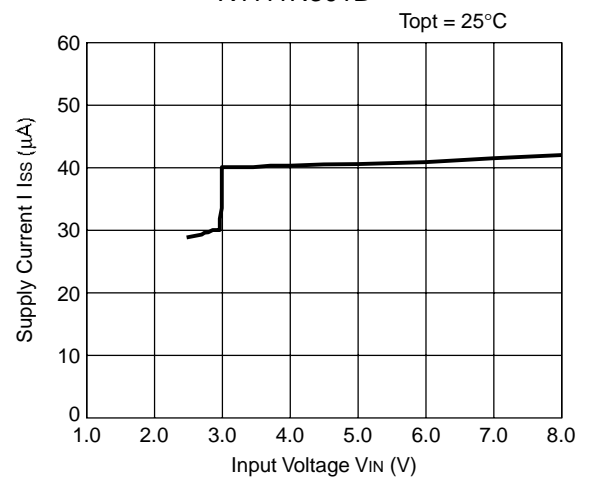

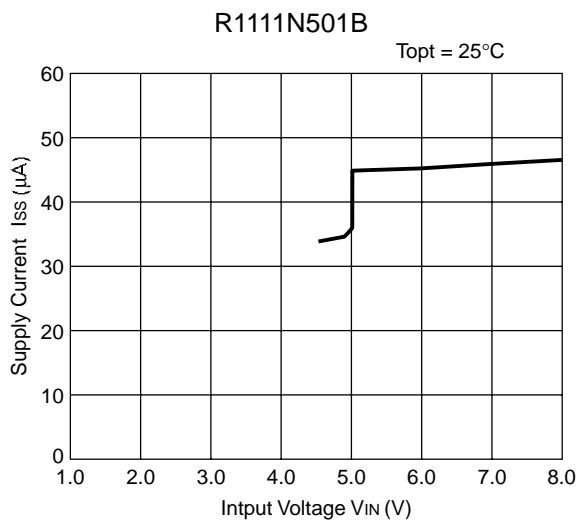

6) Supply Current vs. Temperature

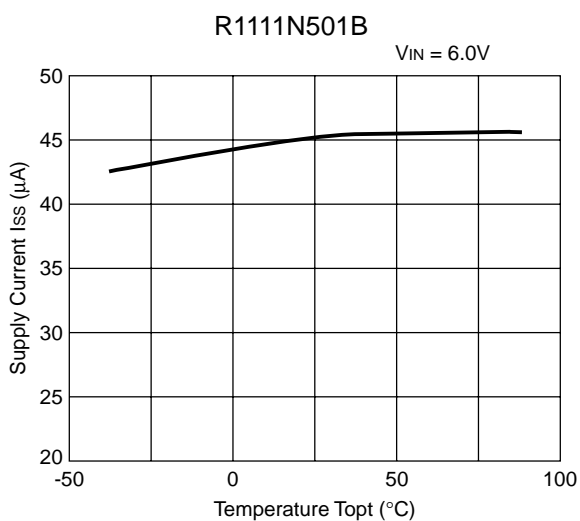
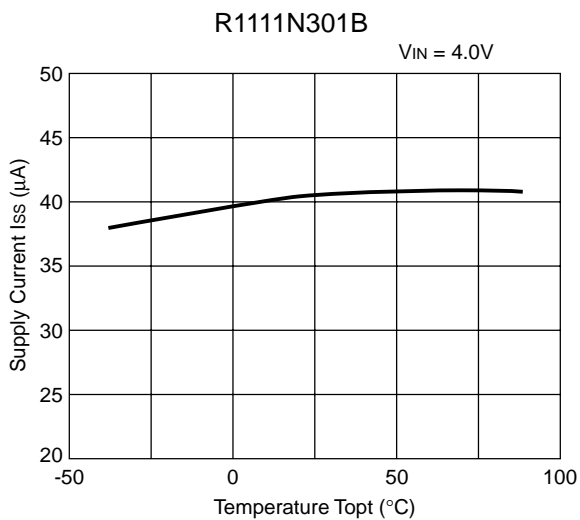

7) Dropout Voltage vs. Set Output Voltage
R1111Nxx1B

Topt = 25 °C



8) Ripple Rejection vs. Frequency
R1111N181B

VIN = 2.8VDC + 0.5Vp-p
COUT = tantal 1.0μF



R1111N181B

VIN = 2.8VDC + 0.5Vp-p
COUT = tantal 2.2μF



R1121N301B

VIN = 4VDC + 0.5Vp-p
COUT = tantal 1.0μF



R1121N301B

VIN = 4VDC + 0.5Vp-p
COUT = tantal 2.2μF



R1111N401B

$V_{IN} = 5.0V_{DC} + 0.5V_{p-p}$
 $C_{OUT} = \text{tantal } 1.0\mu F$



R1111N401B

$V_{IN} = 5.0V_{DC} + 0.5V_{p-p}$
 $C_{OUT} = \text{tantal } 2.2\mu F$



9) Ripple Rejection vs. Input Voltage (DC bias)

R1111N301B

$I_{OUT} = 1mA$
 $C_{OUT} = 2.2\mu F$



R1111N301B

$I_{OUT} = 10mA$
 $C_{OUT} = 2.2\mu F$



R1111N301B

$I_{OUT} = 50mA$
 $C_{OUT} = 2.2\mu F$



10) Line Transient Response

R1111N301B

$I_{OUT}=30mA$
 $t_r=t_f=5\mu s$
 $C_{OUT}=\text{Tantalum } 1.0\mu F$



R1111N301B

$I_{OUT}=30mA$
 $t_r=t_f=5\mu s$
 $C_{OUT}=\text{Tantalum } 2.2\mu F$

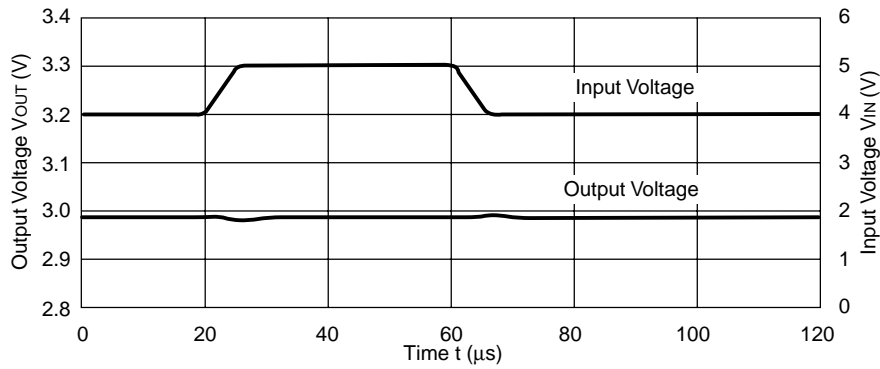

R1111N301B

$I_{OUT}=30mA$
 $t_r=t_f=5\mu s$
 $C_{OUT}=\text{Tantalum } 4.7\mu F$

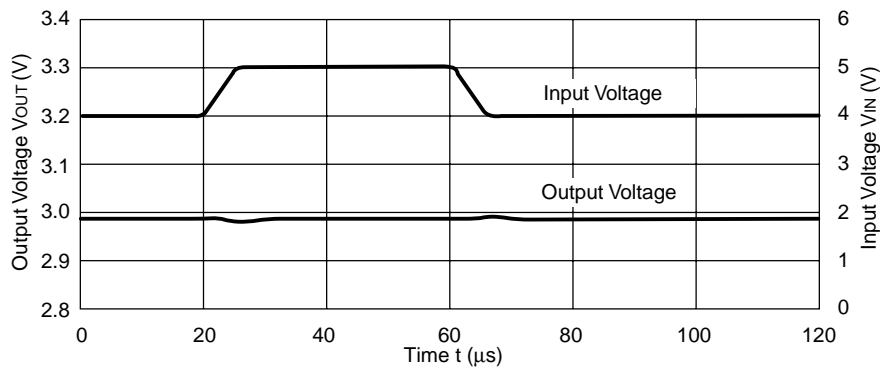

11) Load Transient Response

R1111N301B

$V_{IN}=4V$
 $C_{IN}=\text{Tantalum } 1\mu F$
 $C_{OUT}=\text{Tantalum } 1.0\mu F$



R1111N301B

$V_{IN}=4V$
 $C_{IN}=\text{Tantalum } 1\mu F$
 $C_{OUT}=\text{Tantalum } 2.2\mu F$



R1111N301B

$V_{IN}=4V$
 $C_{IN}=\text{Tantalum } 1\mu F$
 $C_{OUT}=\text{Tantalum } 4.7\mu F$



TECHNICAL NOTES

When using these ICs, consider the following points:

In these ICs, phase compensation is made for securing stable operation even if the load current is varied. For this purpose, be sure to use a capacitor COUT with good frequency characteristics and ESR (Equivalent Series Resistance) of which is in the range described as follows:



Measuring Circuit for white noise;R1111N301B

The relations between I_{OUT} (Output Current) and ESR of Output Capacitor are shown below. The conditions when the white noise level is under $40\mu V(Avg.)$ are marked as the hatched area in the graph.

(note: When the additional ceramic capacitors are connected to the Output Pin with Output capacitor for phase compensation, the operation might be unstable. Because of this, test these ICs with as same external components as ones to be used on the PCB.)

<measuring conditions>

- (1) $V_{IN}=4V$
- (2) Frequency band :10Hz to 1MHz
- (3) Temperature : $25^{\circ}C$

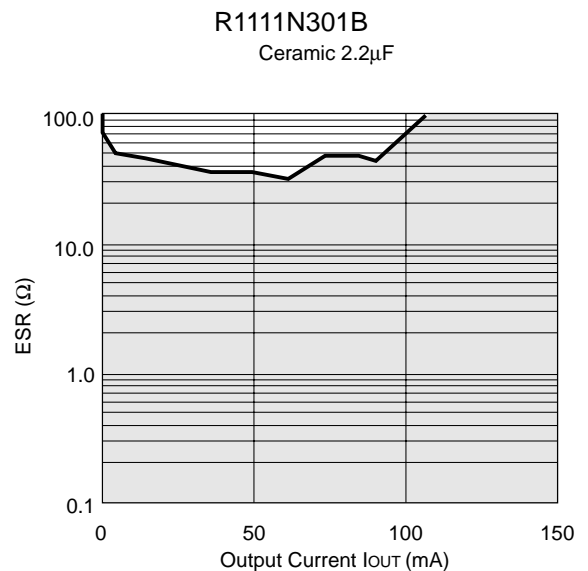

- Make V_{DD} and GND line sufficient. When the impedance of these is high, the noise might be picked up or not work correctly.
- Connect the capacitor with a capacitance of $1\mu F$ or more between V_{DD} and GND as close as possible.
- Set external components, especially Output Capacitor, as close as possible to the ICs and make wiring shortest.

■ TYPICAL APPLICATION





Компания «ЭлектроПласт» предлагает заключение долгосрочных отношений при поставках импортных электронных компонентов на взаимовыгодных условиях!

Наши преимущества:

- Оперативные поставки широкого спектра электронных компонентов отечественного и импортного производства напрямую от производителей и с крупнейших мировых складов;
- Поставка более 17-ти миллионов наименований электронных компонентов;
- Поставка сложных, дефицитных, либо снятых с производства позиций;
- Оперативные сроки поставки под заказ (от 5 рабочих дней);
- Экспресс доставка в любую точку России;
- Техническая поддержка проекта, помощь в подборе аналогов, поставка прототипов;
- Система менеджмента качества сертифицирована по Международному стандарту ISO 9001;
- Лицензия ФСБ на осуществление работ с использованием сведений, составляющих государственную тайну;
- Поставка специализированных компонентов (Xilinx, Altera, Analog Devices, Intersil, Interpoint, Microsemi, Aeroflex, Peregrine, Syfer, Eurofarad, Texas Instrument, Miteq, Cobham, E2V, MA-COM, Hittite, Mini-Circuits, General Dynamics и др.);

Помимо этого, одним из направлений компании «ЭлектроПласт» является направление «Источники питания». Мы предлагаем Вам помощь Конструкторского отдела:

- Подбор оптимального решения, техническое обоснование при выборе компонента;
- Подбор аналогов;
- Консультации по применению компонента;
- Поставка образцов и прототипов;
- Техническая поддержка проекта;
- Защита от снятия компонента с производства.



Как с нами связаться

Телефон: 8 (812) 309 58 32 (многоканальный)

Факс: 8 (812) 320-02-42

Электронная почта: org@eplast1.ru

Адрес: 198099, г. Санкт-Петербург, ул. Калинина, дом 2, корпус 4, литера А.