

LOC		DIST		REVISIONS			
P	LTN	DESCRIPTION	DATE	DWN	APVD		
	H4	ADDED DASH NUMBER -33	25FEB2013	CZ	SZ		

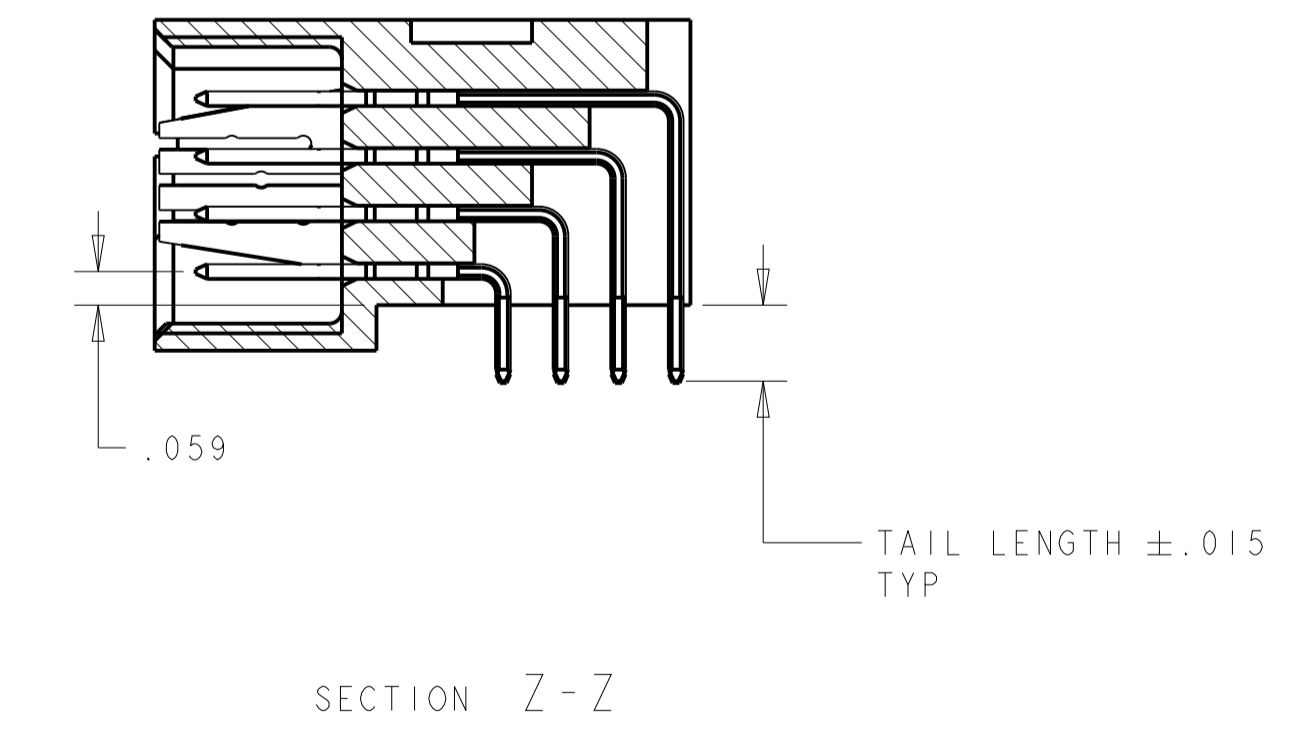
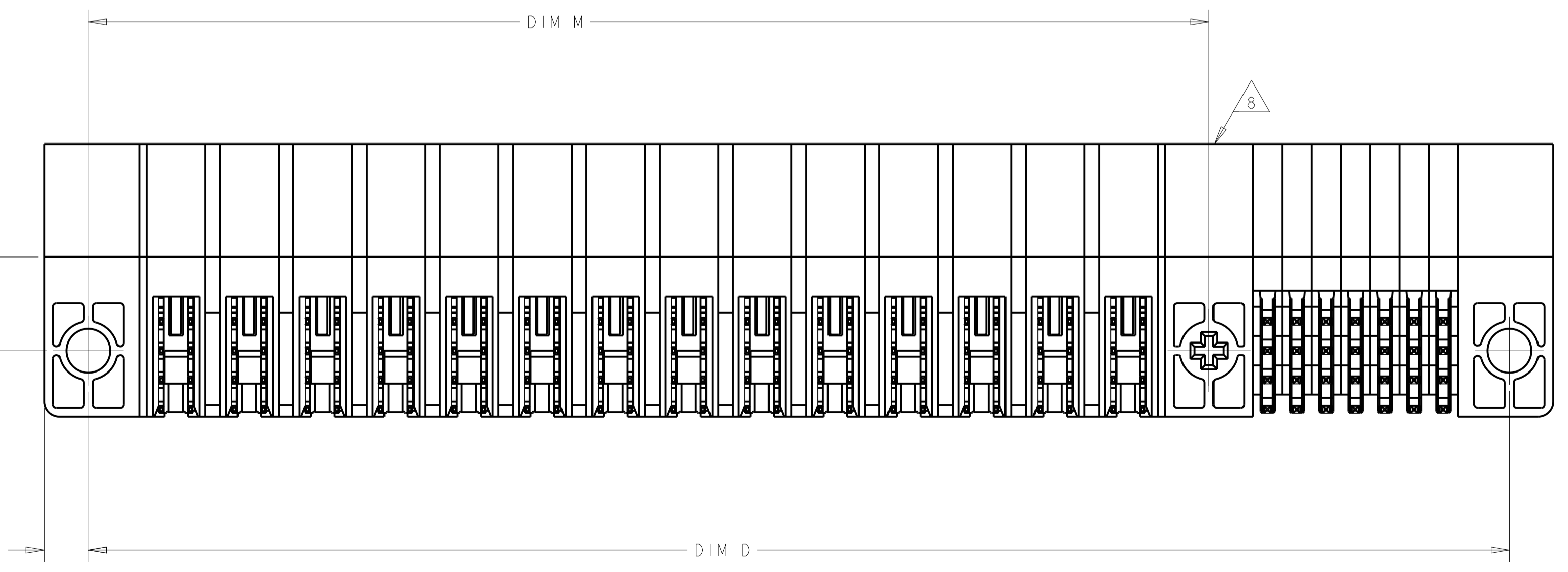
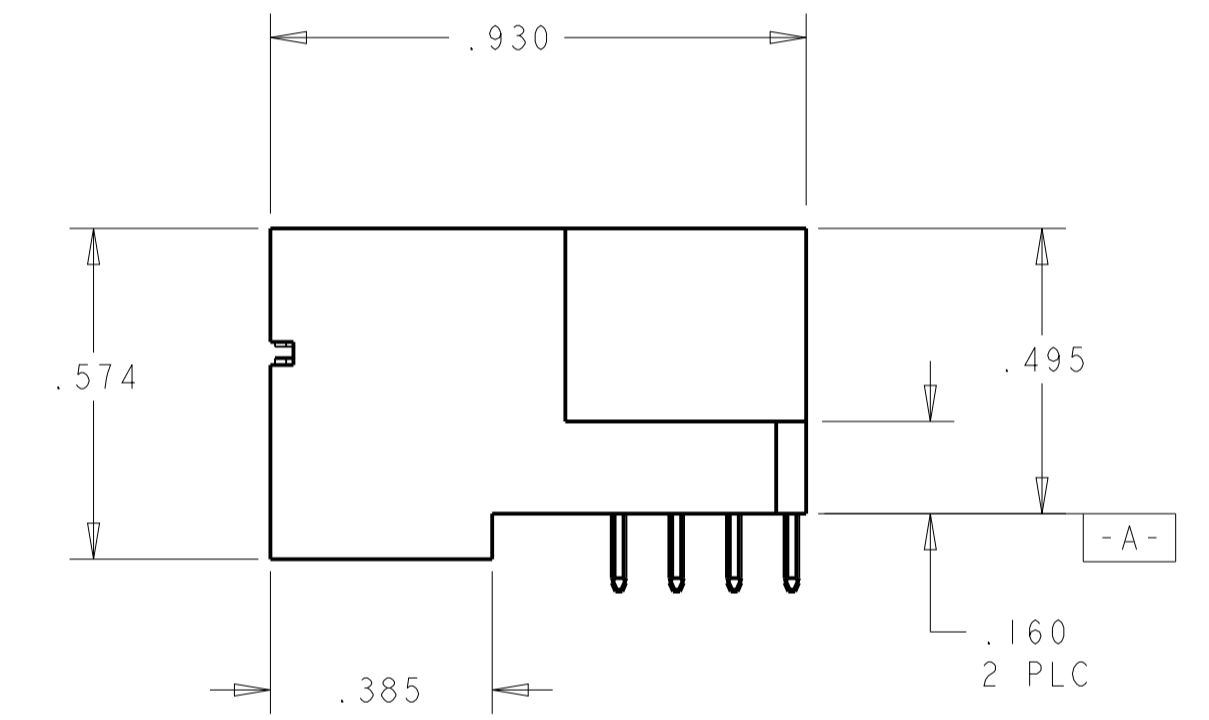
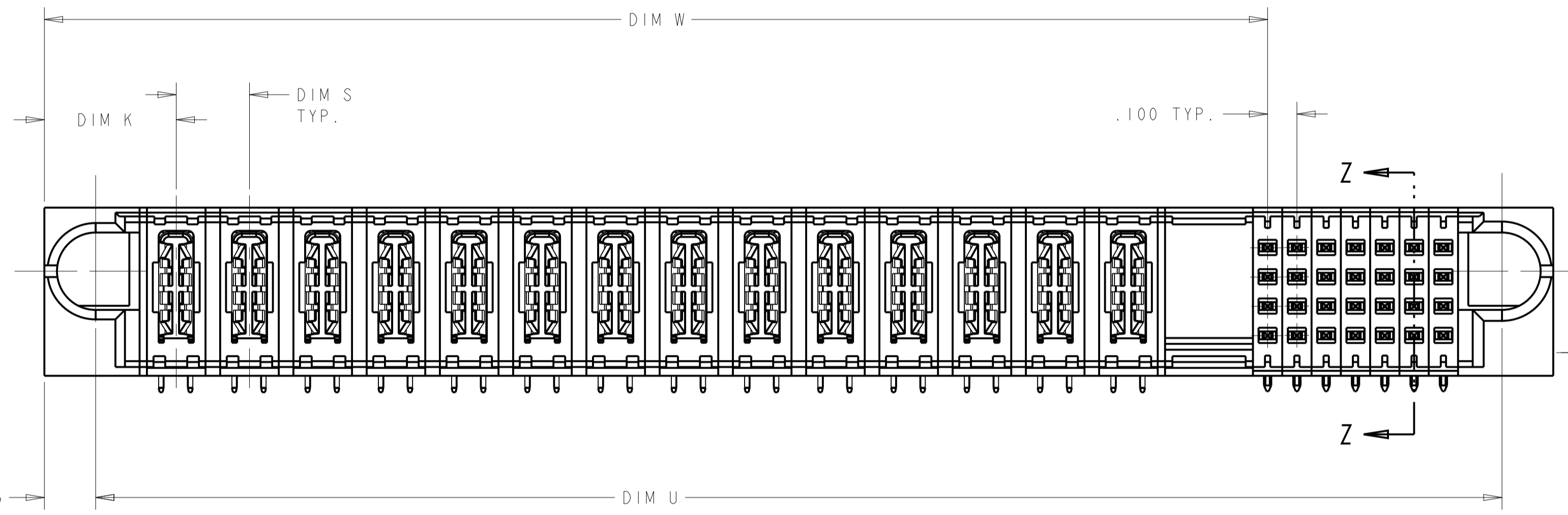
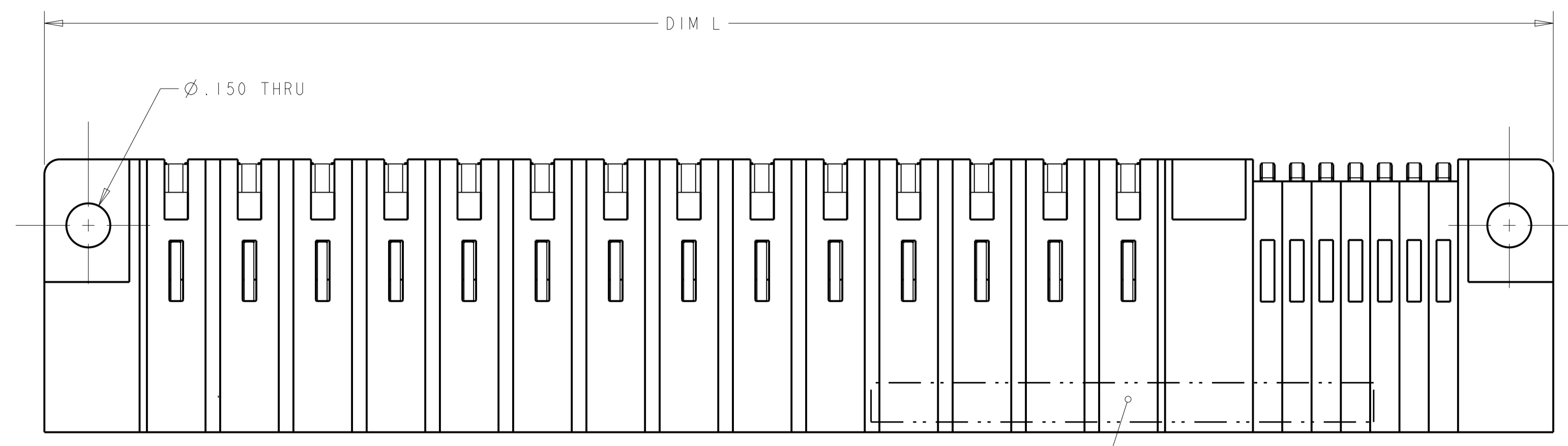

THIS DRAWING IS A CONTROLLED DOCUMENT.		DWN R. GRZYBOWSKI 24JAN05	TE Connectivity RIGHT ANGLE SOLDER HEADER ASSEMBLY MULTI-BEAM XL	
DIMENSIONS: INCHES		CHK M. PERCHERKE 24JAN05		
TOLERANCES UNLESS OTHERWISE SPECIFIED:		APVD M. PERCHERKE	PRODUCT SPEC	RESTRICTED TO
0 PLC $\pm .01$ 1 PLC $\pm .01$ 2 PLC $\pm .01$ 3 PLC $\pm .005$ 4 PLC $\pm .002$ ANGLES $\pm .020$		APPLICATION SPEC	108-1973	
MATERIAL		FINISH	114-13038	
		WEIGHT		
		CUSTOMER DRAWING		
SCALE 4:1		SHEET 1 OF 13		REV H6

LOC	DIST	REVISIONS			
		REV	DATE	BY	APPV
ES	00				

- 1 "AMP", PART NUMBER, AND DATECODE TO BE MARKED IN AREA SHOWN.
- 2 MATERIAL: HOUSING - GLASS FILLED HIGH TEMP THERMO PLASTIC, UL94 V-0
SIGNAL CONTACT - COPPER ALLOY
POWER CONTACT - HIGH CONDUCTIVITY COPPER ALLOY
- 3 CONTACT PLATING: NOBLE METAL PLATING ON CONTACT FUNCTIONAL AREA OF POWER AND SIGNAL CONTACTS
- 4 MECHANICAL CONNECTOR KEEP OUT ZONE.
- 5 DATUM AND BASIC DIMENSIONS ESTABLISHED BY CUSTOMER.
- 6 PCB - HOLE DIAMETERS ARE FINISHED HOLE SIZE.
- 7 PCB - .0453±.0010 DRILLED HOLES PLATED WITH .0003 MIN Sn OVER .001 TO .003 Cu PLATING TO ACHIEVE A .040 DIAMETER HOLE.
- 8 OPTIONAL CENTER MODULE
- 9 NOT RELEASED FOR PRODUCTION
- 10 VARIABLE DIMENSIONS SHOWN ON TABLE

DIM U	DIM S	DIM W	DIM D	DIM M	DIM L	DIM K	DESCRIPTION	PART NUMBER
1.900	.250	1.375	1.950	-	2.250	.450	4P + 24S	3-6450332-4
2.825	△	2.300	2.875	-	3.175	.475	3ACP + 4P + 24S	3-6450332-3
1.600	.250	1.375	1.650	-	1.950	.450	4P + 12S	3-6450332-2
2.825	△	2.300	2.875	-	3.175	.475	3ACP + 4P + 24S	3-6450332-1
3.225	△	2.675	3.275	-	3.575	.525	9P + 24S	3-6450332-0
2.700	△	2.275	2.750	-	3.050	.450	4ACP+3P+20S	1-6450332-9
3.225	△	2.675	3.275	-	3.575	.525	3ACP+6P+24S	2-6450332-8
1.650	.200	1.225	1.700	-	2.000	.450	4P + 20S	2-6450332-6
1.800	△	1.275	1.850	-	2.150	.450	4P + 24S	2-6450332-5
2.900	.250	2.375	2.950	-	3.250	.450	8P + 24S	2-6450332-4
3.225	△	2.675	3.275	-	3.575	.525	3ACP+6P+24S	2-6450332-3
2.150	.250	1.625	2.200	-	2.500	.450	5P + 24S	2-6450332-0
3.225	△	2.675	3.275	-	3.575	.525	3ACP+6P+24S	6450332-9
3.875	△	3.550	3.925	-	4.225	.475	1ACP + 9P + 16S	1-6450332-8
2.300	.250	1.875	2.350	-	2.650	.450	6P+20S	1-6450332-7
3.875	△	3.550	3.925	-	4.225	.475	3ACP+9P+16S	1-6450332-6
5.100	△	2.375	5.150	-	5.450	.450	8P + 112S	1-6450332-4
3.800	△	3.175	3.850	-	4.150	.450	12P + 28S	1-6450332-3
2.275	△	2.050	2.325	-	2.625	.450	5P + 24S	1-6450332-2
1.400	.250	.875	1.450	-	1.750	.450	2P + 24S	6450332-8
1.100	-	.575	1.150	-	1.450	.425	1P + 24S	6450332-6
4.425	.250	3.875	4.475	-	4.775	.450	14P + 24S	6450332-5
2.675	.250	2.125	2.725	-	3.025	.450	7P + 24S	6450332-4
2.925	.250	2.375	2.975	-	3.275	.450	8P + 24S	6450332-3
4.500	.250	3.875	4.550	-	4.850	.450	14P + 28S	6450332-2

THIS DRAWING IS A CONTROLLED DOCUMENT.

OWN: R. GRZYBOWSKI 24JAN05
CHK: M. PERCHERKE 24JAN05
APPV: M. PERCHERKE

STE TE Connectivity

NAME: RIGHT ANGLE SOLDER HEADER ASSEMBLY MULTI-BEAM XL

PRODUCT SPEC: 108-1973
APPLICATION SPEC: 114-13038

SIZE: A1 CAGE CODE: 6450332 DRAWING NO: 100779

RESTRICTED TO: -

MATERIAL: - FINISH: - WEIGHT: -

CUSTOMER DRAWING SCALE: 4:1 SHEET: 2 OF 13 REV: H6

LOC	DIST	REVISIONS			
ES	00	REV	DATE	BY	APPROV
		1			
		2			
		3			
		4			
		5			
		6			
		7			
		8			
		9			
		10			
		11			
		12			
		13			
		14			
		15			
		16			
		17			
		18			
		19			
		20			

ASSY PART NUMBER	ROWS	POWER														SIGNAL						
		P1	P2	P3	P4	P5	P6	P7	P8	P9	P10	P11	P12	P13	P14	1	2	3	4	5	6	7
6450332-2	D C B A	PM	PM	PM	PM	PM	PM	PM	PM	PM	PM	PM	PM	PM	E	E	E	E	E	E	E	E
															F	F	F	F	F	F	F	F
															G	G	G	G	G	G	G	G
															S	S	S	S	S	H	H	H
14P + 28S																						

PART NUMBER	ROWS	POWER								SIGNAL					
		P1	P2	P3	P4	P5	P6	P7	P8	1	2	3	4	5	6
6450332-3	D C B A	PM	PM	PM	PM	PM	PM	PM	PM	J	J	J	J	E	E
										K	K	K	K	F	F
										N	N	N	N	G	G
										S	S	S	S	H	H
8P + 24S															

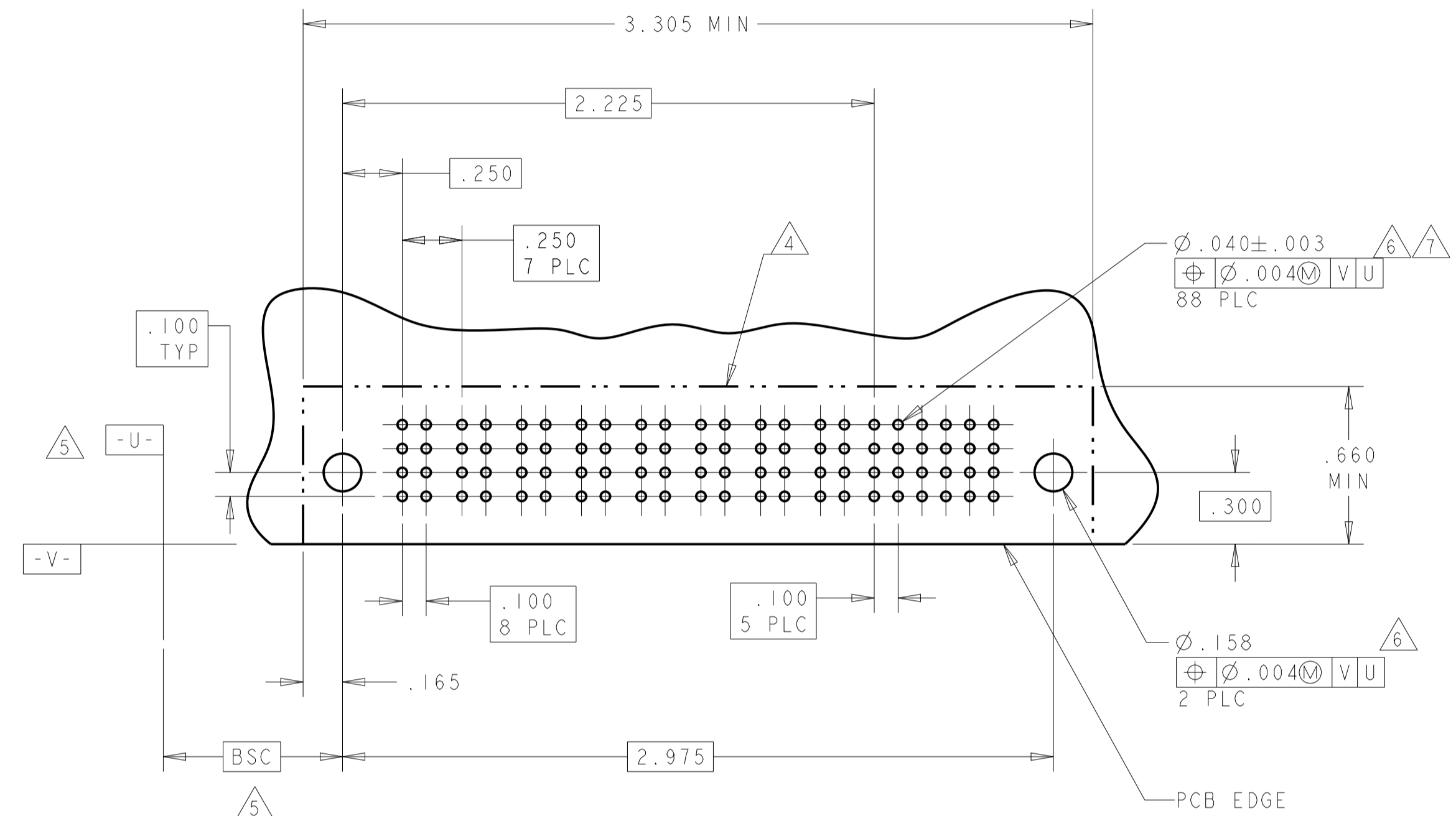
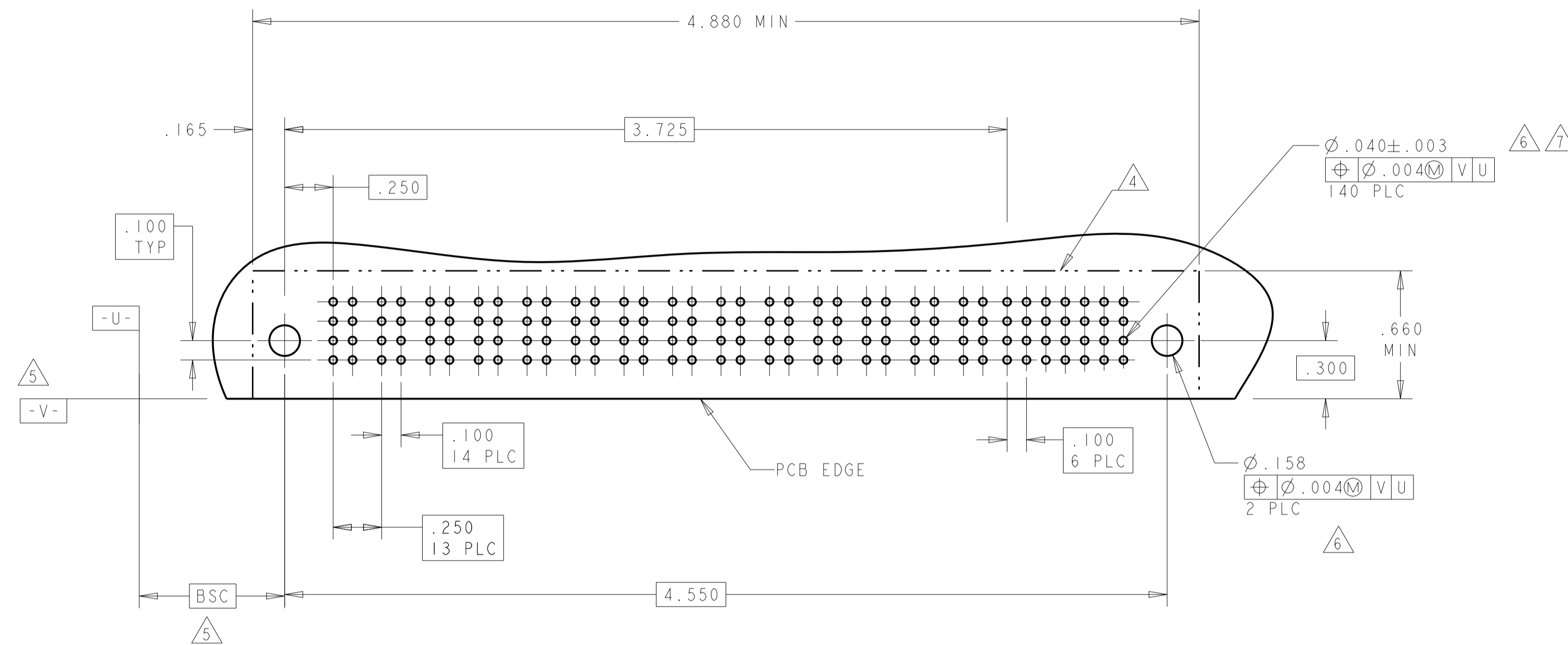

PART NUMBER	ROWS	POWER							SIGNAL					
		P1	P2	P3	P4	P5	P6	P7	1	2	3	4	5	6
6450332-4	D C B A	PM	PM	PM	PM	PM	PM	PM	J	J	E	J	J	J
									K	K	K	K	K	K
									N	N	N	N	N	N
									S	S	S	S	S	S
7P + 24S														

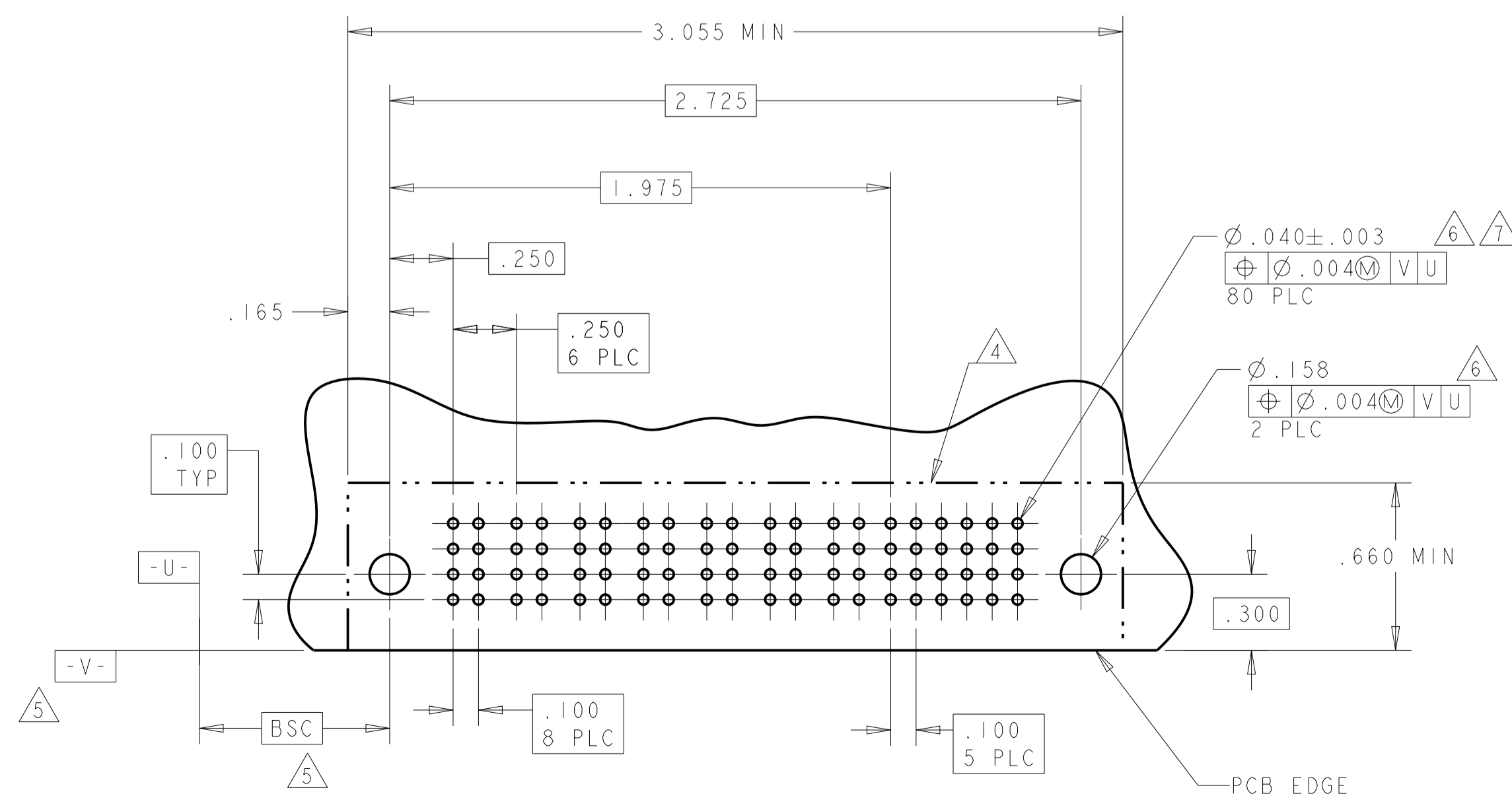

CODE	MATING SEQUENCE	TAIL LENGTH	ROW
Z	STD	.090	D
Y	STD	.090	C
R	STD	.090	B
O	STD	.090	A
A4	MLBF	.090	D
A3	MLBF	.090	C
A2	MLBF	.090	B
A1	MLBF	.090	A
E	MLBF	.135	D
F	MLBF	.135	C
G	MLBF	.135	B
H	MLBF	.135	A
J	STD	.135	D
K	STD	.135	C
N	STD	.135	B
S	STD	.135	A

CODE	TAIL LENGTH
PA	.090
PM	.135

THIS DRAWING IS A CONTROLLED DOCUMENT. **STE** TE Connectivity

APVD: M. PERCHERKE
 PRODUCT SPEC: 108-1973
 APPLICATION SPEC: 114-13038
 WEIGHT: -
 FINISH: -

NAME: RIGHT ANGLE SOLDER HEADER ASSEMBLY MULTI-BEAM XL
 SIZE: A1
 CAGE CODE: 100779
 DRAWING NO: 6450332
 SCALE: 4:1
 SHEET: 3 OF 13
 REV: H6

LOC	DIST	REV	DATE	APPV
ES	00			

REVISIONS				
REV	DATE	APPV	DESCRIPTION	BY
-	-	-	SEE SHEET 1	-

PART NUMBER	ROWS	POWER														SIGNAL					
		P1	P2	P3	P4	P5	P6	P7	P8	P9	P10	P11	P12	P13	P14	1	2	3	4	5	6
6450332-5	D C B A	PM	PM	PM	PM	PM	PM	PM	PM	PM	PM	PM	PM	PM	PM	E	E	E	E	E	E
		PM	PM	PM	PM	PM	PM	PM	PM	PM	PM	PM	PM	PM	PM	F	F	F	F	F	F
		PM	PM	PM	PM	PM	PM	PM	PM	PM	PM	PM	PM	PM	PM	G	G	G	G	G	G
		PM	PM	PM	PM	PM	PM	PM	PM	PM	PM	PM	PM	PM	PM	H	H	S	S	H	H
14P + 24S																					

PART NUMBER	ROWS	POWER					SIGNAL							
		P1	P2	P3	P4	P5	1	2	3	4	5	6		
1-6450332-2	D C B A	PM	PM	PM	PM	PM								
		PM	PM	PM	PM	PM				J	J	J		
		PM	PM	PM	PM	PM				K	K	K		
		PM	PM	PM	PM	PM				N	N	N		
5P + 24S		NO CONTACTS LOADED												

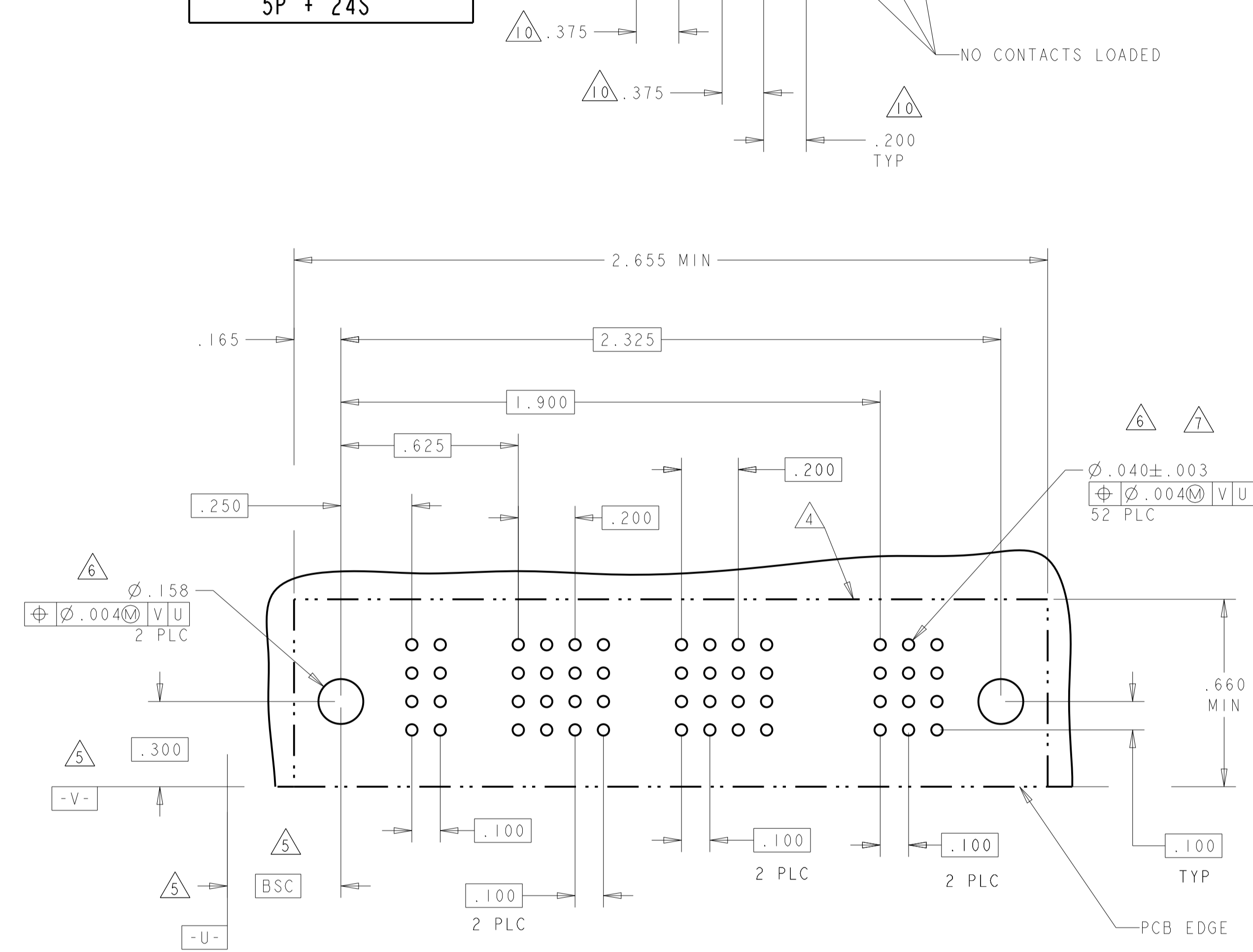
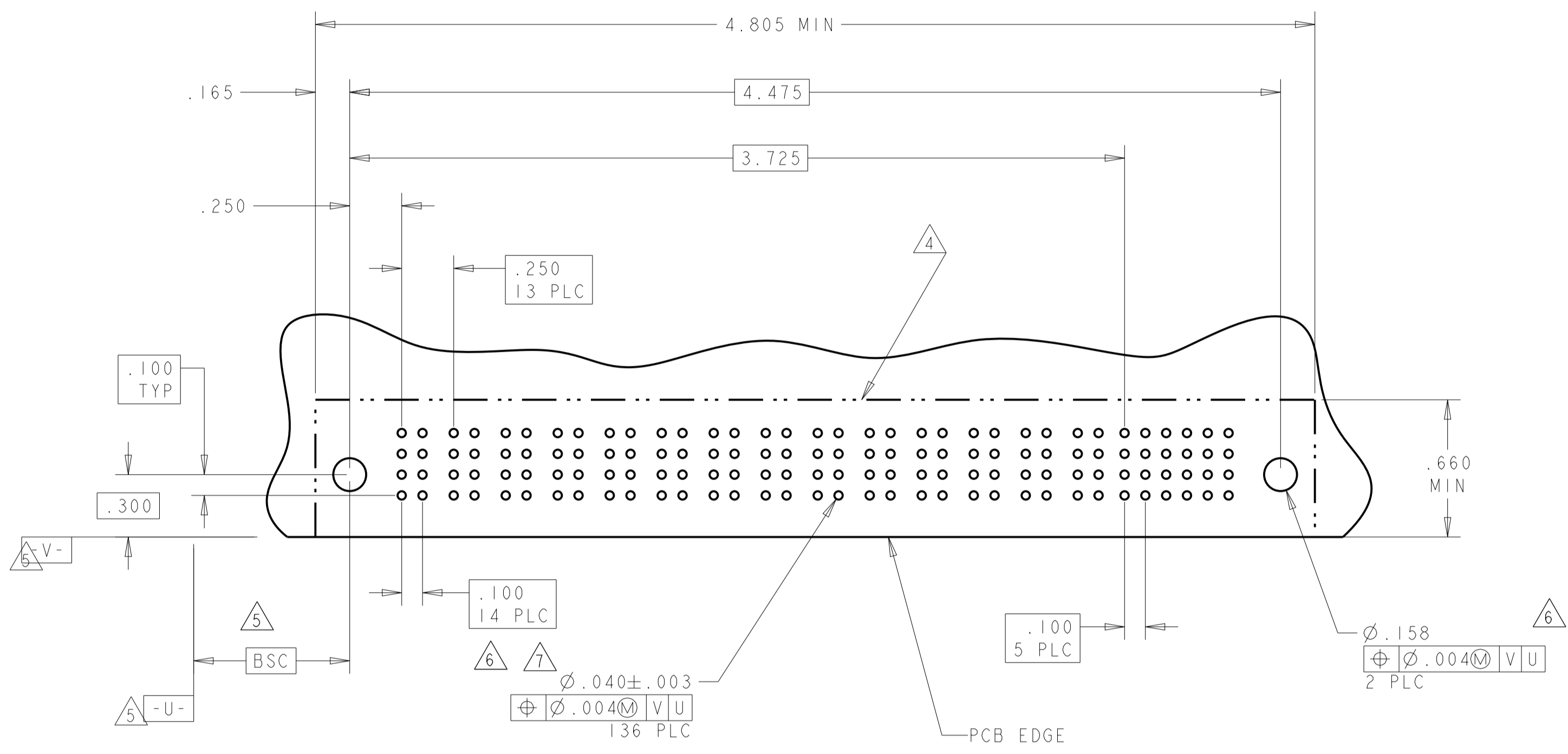

PART NUMBER	ROWS	POWER	SIGNAL					
		P1	1	2	3	4	5	6
6450332-6	D C B A	PM	E	E	E	E	E	J
		PM	F	F	F	F	F	F
		PM	G	G	G	G	G	G
		PM	H	H	H	H	H	H
1P + 24S								

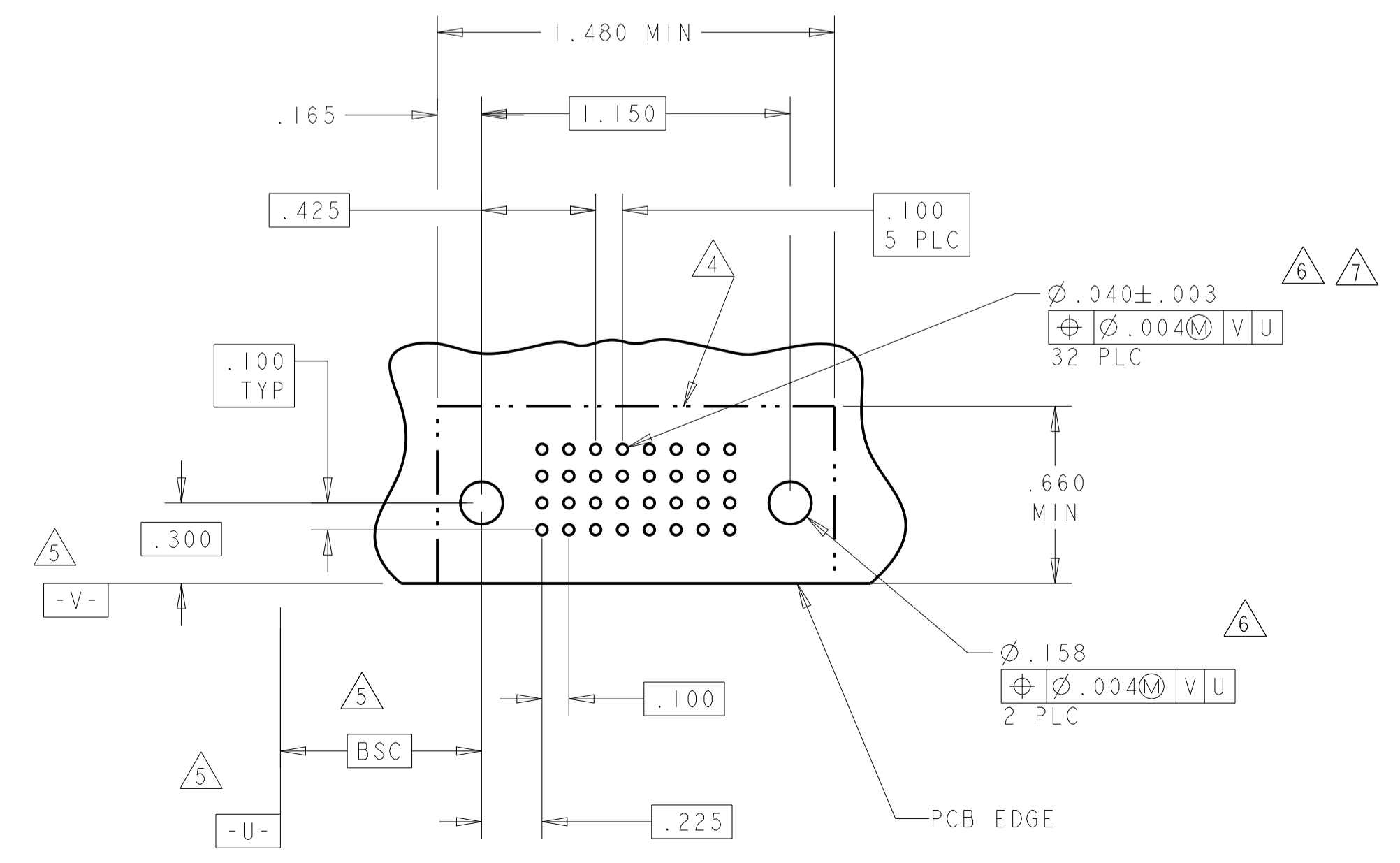

THIS DRAWING IS A CONTROLLED DOCUMENT. DWG: R. GRZYBOWSKI 24JAN05
 CHK: M. PERCHERKE 24JAN05
 APVD: M. PERCHERKE

STE TE Connectivity

NAME: RIGHT ANGLE SOLDER HEADER ASSEMBLY MULTI-BEAM XL

PRODUCT SPEC: 108-1973
 APPLICATION SPEC: 114-13038

SIZE: 114-13038
 WEIGHT: A100779
 CUSTOMER DRAWING: C=6450332

SCALE: 4:1 SHEET 4 OF 13 REV H6

LOC	DIST	REV	DATE	DWN	APVD
ES	00				
REVISIONS			DESCRIPTION		
-			SEE SHEET 1		

PART NUMBER	ROWS	POWER											SIGNAL						
		P1	P2	P3	P4	P5	P6	P7	P8	P9	P10	P11	P12	1	2	3	4	5	6
I-6450332-3	D C B A	PM	PM	PM	PM	PM	PM	PM	PM	PM	PM	PM	J				J	J	J
		PM	PM	PM	PM	PM	PM	PM	PM	PM	PM	PM	K				K	K	K
		PM	PM	PM	PM	PM	PM	PM	PM	PM	PM	PM	N				N	N	N
		PM	PM	PM	PM	PM	PM	PM	PM	PM	PM	PM	S				S	S	S
12P + 28S													NO CONTACTS LOADED						

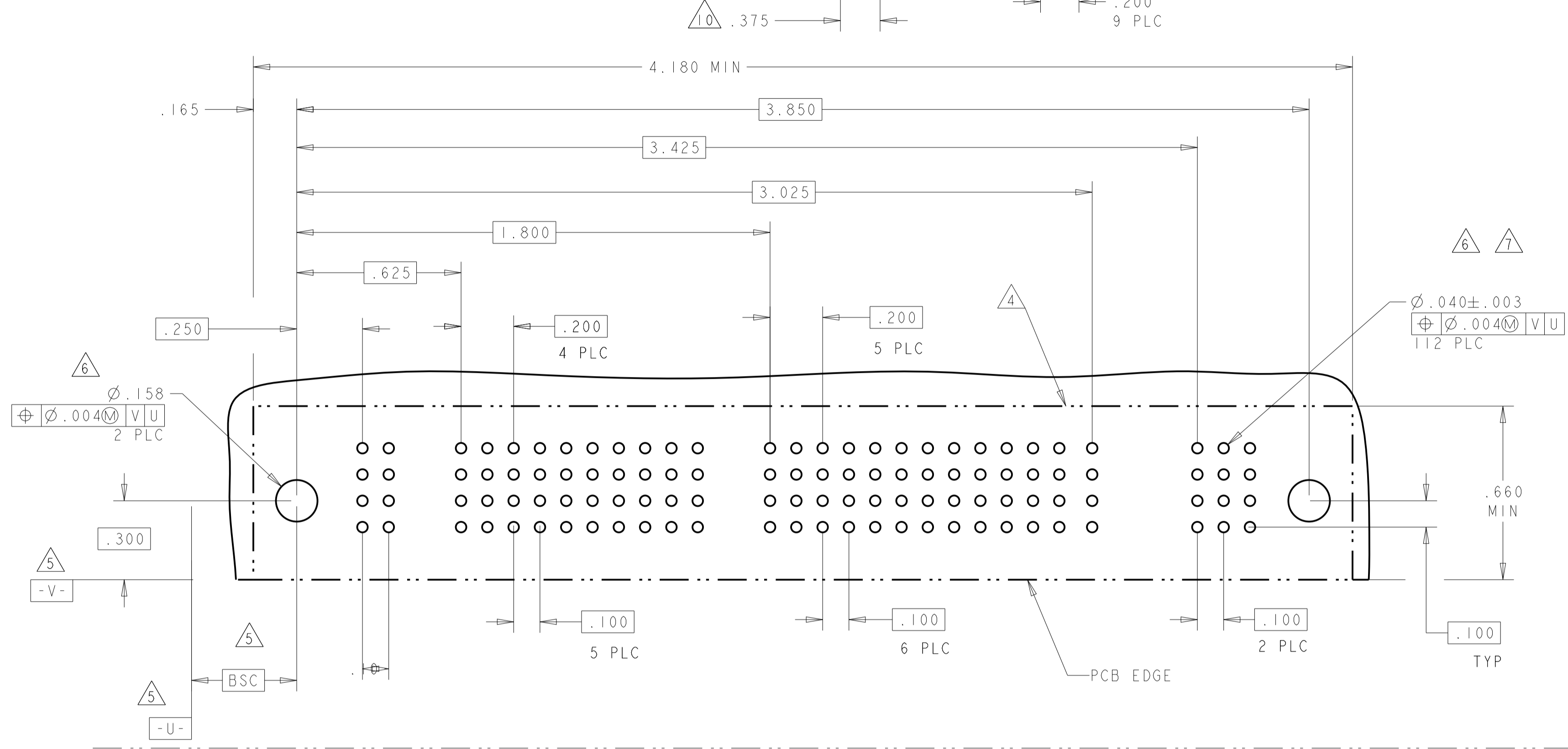

PART NUMBER	ROWS	POWER								SIGNAL																																	
		P1	P2	P3	P4	P5	P6	P7	P8	1	2	3	4	5	6	7	8	9	10	11	12	13	14	15	16	17	18	19	20	21	22	23	24	25	26	27	28						
I-6450332-4	D C B A	PM	PM	PM	PM	PM	PM	PM	PM	J				J	J	J	J	J	J	J	J	J	J	J	J	J	J	J	J	J	J	J	J	J	J	J	J	J	J	J			
		PM	PM	PM	PM	PM	PM	PM	PM	K				K	K	K	K	K	K	K	K	K	K	K	K	K	K	K	K	K	K	K	K	K	K	K	K	K	K	K	K	K	
		PM	PM	PM	PM	PM	PM	PM	PM	N				N	N	N	N	N	N	N	N	N	N	N	N	N	N	N	N	N	N	N	N	N	N	N	N	N	N	N	N	N	N
		PM	PM	PM	PM	PM	PM	PM	PM	S				S	S	S	S	S	S	S	S	S	S	S	S	S	S	S	S	S	S	S	S	S	S	S	S	S	S	S	S	S	S
8P + 112S										NO CONTACTS LOADED																																	

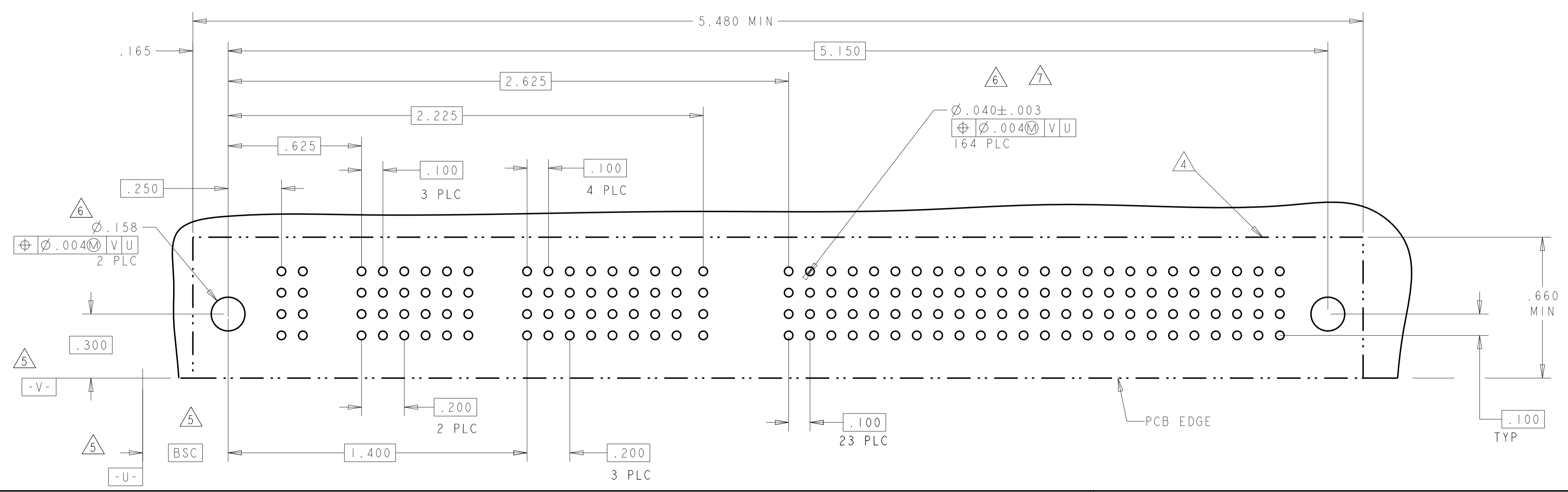

THIS DRAWING IS A CONTROLLED DOCUMENT.

OWN: R. GRZYBOWSKI 24JAN05
 CHK: M. PERCHERKE 24JAN05

DIMENSIONS: INCHES

TOLERANCES UNLESS OTHERWISE SPECIFIED:
 0 PLC ± .01
 1 PLC ± .01
 2 PLC ± .01
 3 PLC ± .005
 4 PLC ± .002
 ANGLES 90°

MATERIAL: FINISH:

APVD: M. PERCHERKE
 PRODUCT SPEC: 108-1973
 APPLICATION SPEC: 114-13038
 WEIGHT: CUSTOMER DRAWING

NAME: RIGHT ANGLE SOLDER HEADER ASSEMBLY MULTI-BEAM XL

SIZE: A1
 CAGE CODE: 6450332
 DRAWING NO: 100779

RESTRICTED TO: H6

SCALE: 4:1
 SHEET 5 OF 13
 REV: H6

LOC	DIST	REVISIONS			
P	LTH	DESCRIPTION	DATE	DMN	APVD
ES	00	SEE SHEET 1			

PART NUMBER	ROWS	POWER												SIGNAL			
		P1	P2	P3	P4	P5	P6	P7	P8	P9	P10	P11	P12	1	2	3	4
I-6450332-6	D C B A	PM	PM	PM	PM	PM	PM	PM	PM	PM	PM	PM	PM	J	J	J	J
		PM	PM	PM	PM	PM	PM	PM	PM	PM	PM	PM	PM	K	K	K	K
		PM	PM	PM	PM	PM	PM	PM	PM	PM	PM	PM	PM	N	N	N	N
		PM	PM	PM	PM	PM	PM	PM	PM	PM	PM	PM	PM	S	S	S	H

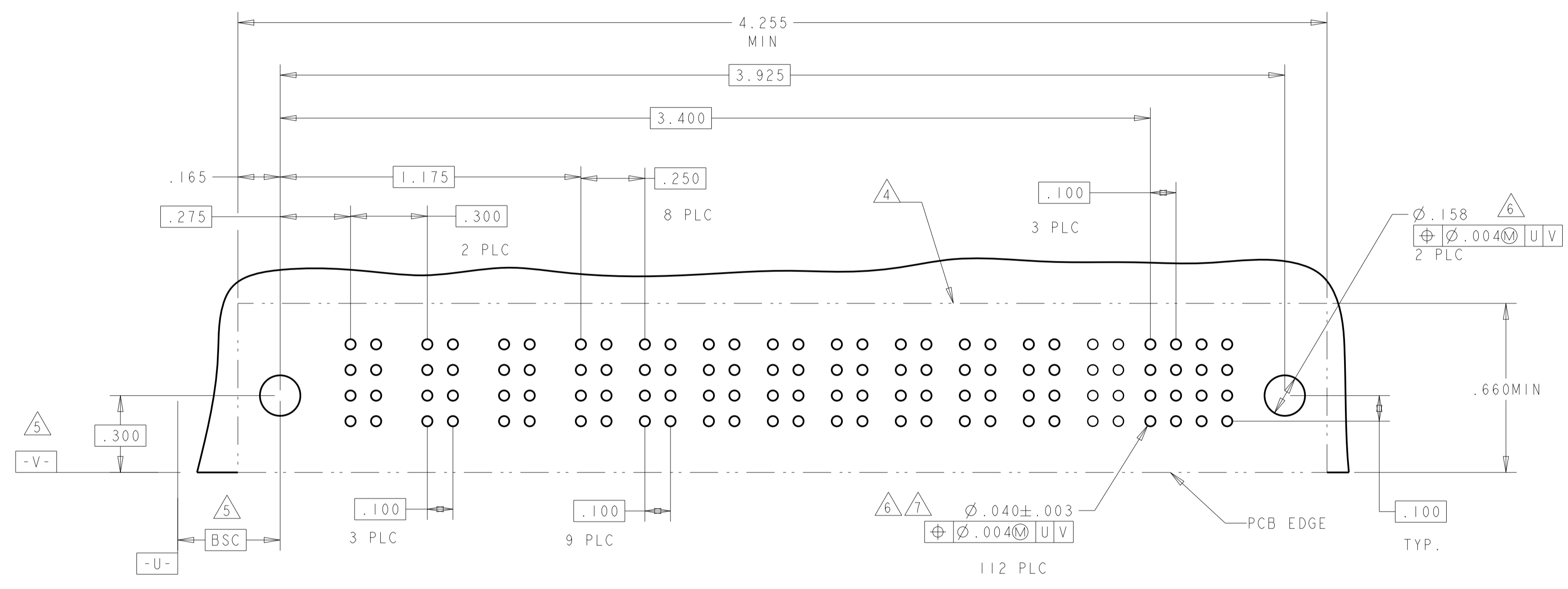

PART NUMBER	ROWS	POWER						SIGNAL				
		P1	P2	P3	P4	P5	P6	1	2	3	4	5
I-6450332-7	D C B A	PM	PM	PM	PM	PM	PM	J	J	J	J	J
		PM	PM	PM	PM	PM	PM	K	K	K	K	K
		PM	PM	PM	PM	PM	PM	N	N	N	N	N
		PM	PM	PM	PM	PM	PM	H	S	S	S	S

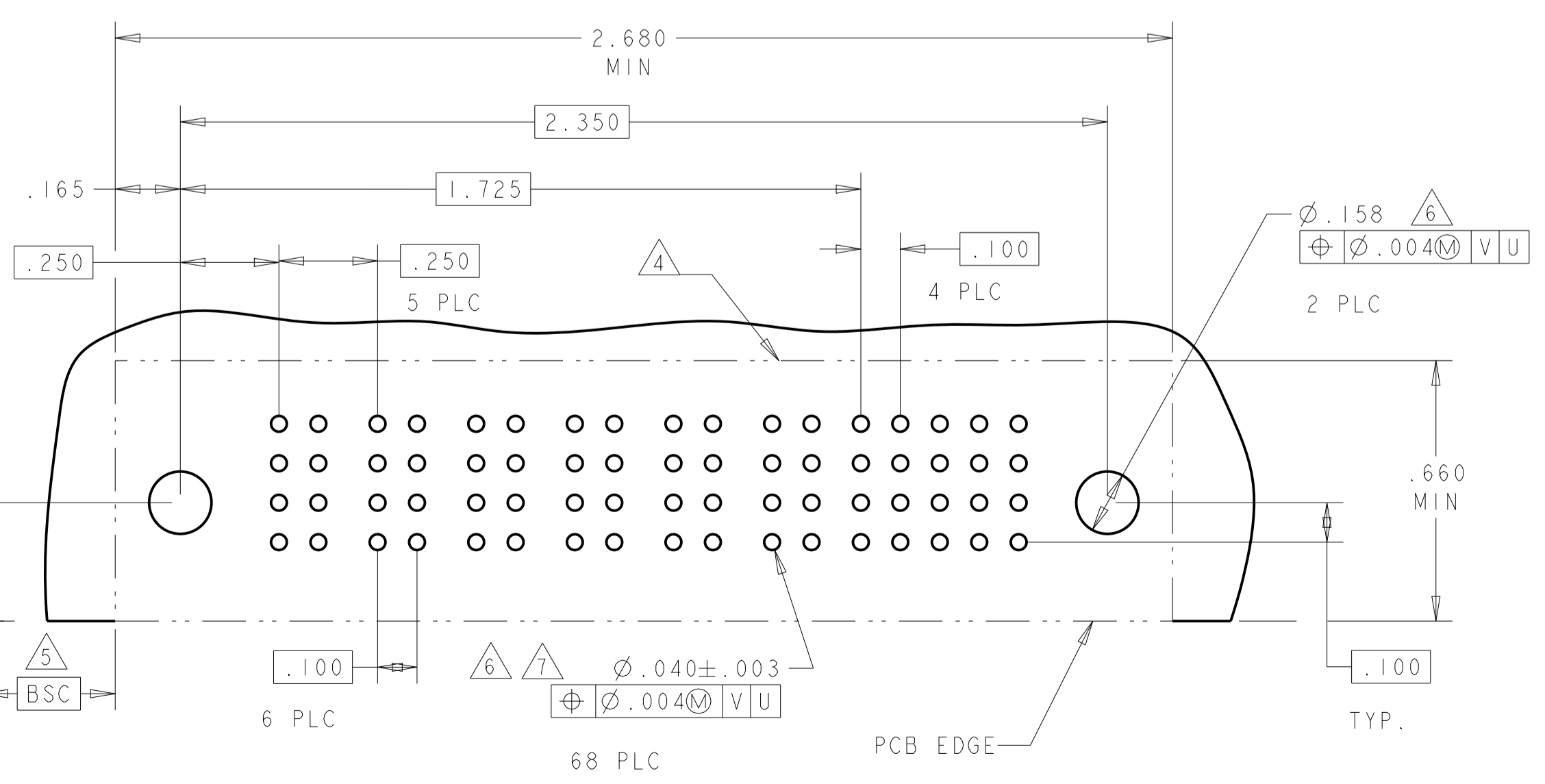

(B1) ADD SHEET 5 OF 6

THIS DRAWING IS A CONTROLLED DOCUMENT.		DMN: R. GRZYBOWSKI 24JAN05	TE Connectivity
DIMENSIONS: INCHES		CHK: M. PERCHERKE 24JAN05	
		APVD: M. PERCHERKE	NAME: RIGHT ANGLE SOLDER HEADER ASSEMBLY MULTI-BEAM XL
TOLERANCES UNLESS OTHERWISE SPECIFIED:		PRODUCT SPEC: 108-1973	SIZE: A100779
0 PLC ±.01		APPLICATION SPEC: 114-13038	CAGE CODE: 6450332
1 PLC ±.01		WEIGHT: -	RESTRICTED TO: -
2 PLC ±.01		CUSTOMER DRAWING	SCALE: 4:1 SHEET 6 OF 13 REV: H6
3 PLC ±.005			
4 PLC ±.002			
ANGLES ±.020			

LOC	DIST	REV	DATE	BY	APPV
ES	00				

REVISIONS					
REV	DATE	BY	APPV	DESCRIPTION	
-	-	-	-	SEE SHEET 1	

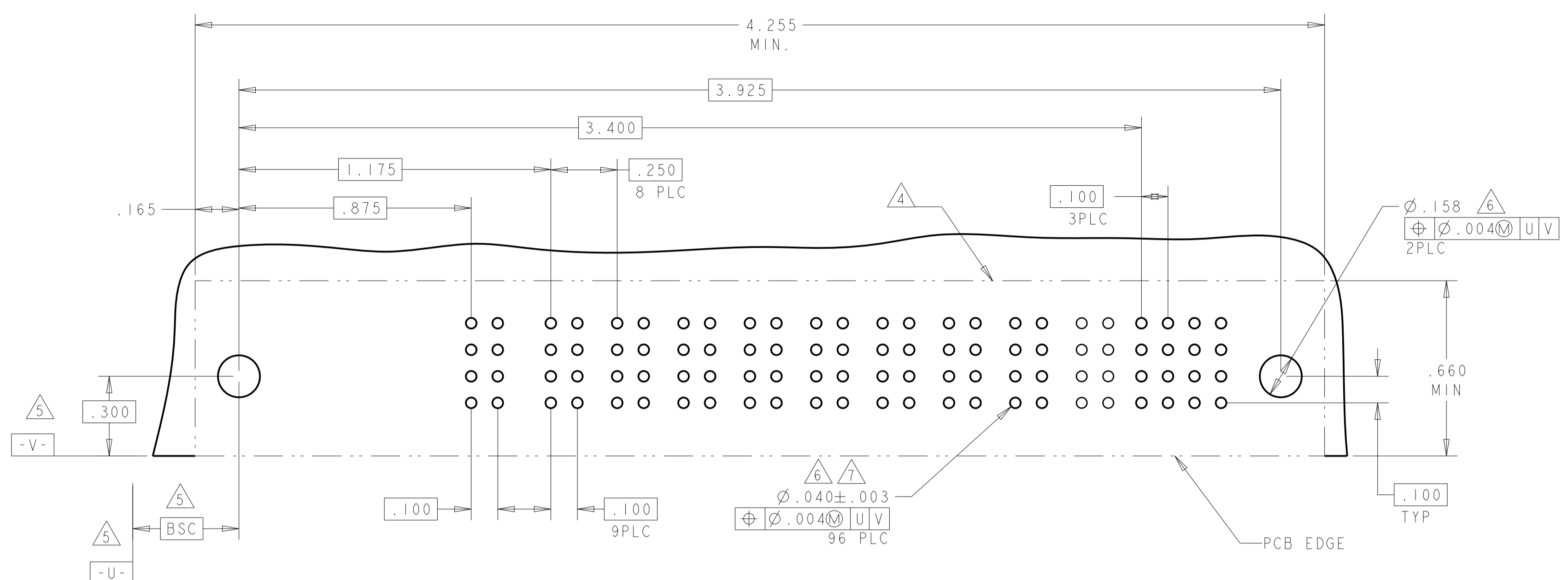

PART NUMBER	ROWS	POWER												SIGNAL			
		P1	P2	P3	P4	P5	P6	P7	P8	P9	P10	P11	P12	1	2	3	4
1-6450332-8	D													J	J	J	J
	C													K	K	K	K
	B													N	N	N	N
A														S	S	S	H
IACP + 9P + 16S																	

PART NUMBER	ROWS	POWER									SIGNAL					
		P1	P2	P3	P4	P5	P6	P7	P8	P9	1	2	3	4	5	6
6450332-9	D	PM	PM	PM	PM	PM	PM	PM	PM	PM	J	E	J	J	J	E
	C										K	K	K	K	F	F
	B										N	N	N	N	G	G
	A										S	S	S	S	H	S
3ACP + 6P + 24S																

PART NUMBER	ROWS	POWER									SIGNAL					
		P1	P2	P3	P4	P5	P6	P7	P8	P9	1	2	3	4	5	6
2-6450332-3	D	PM	PM	PM	PM	PM	PM	PM	PM	PM	E	E	E	E	E	E
	C										K	F	F	F	F	F
	B										N	G	G	G	G	G
	A										H	H	H	H	H	S
3ACP + 6P + 24S																

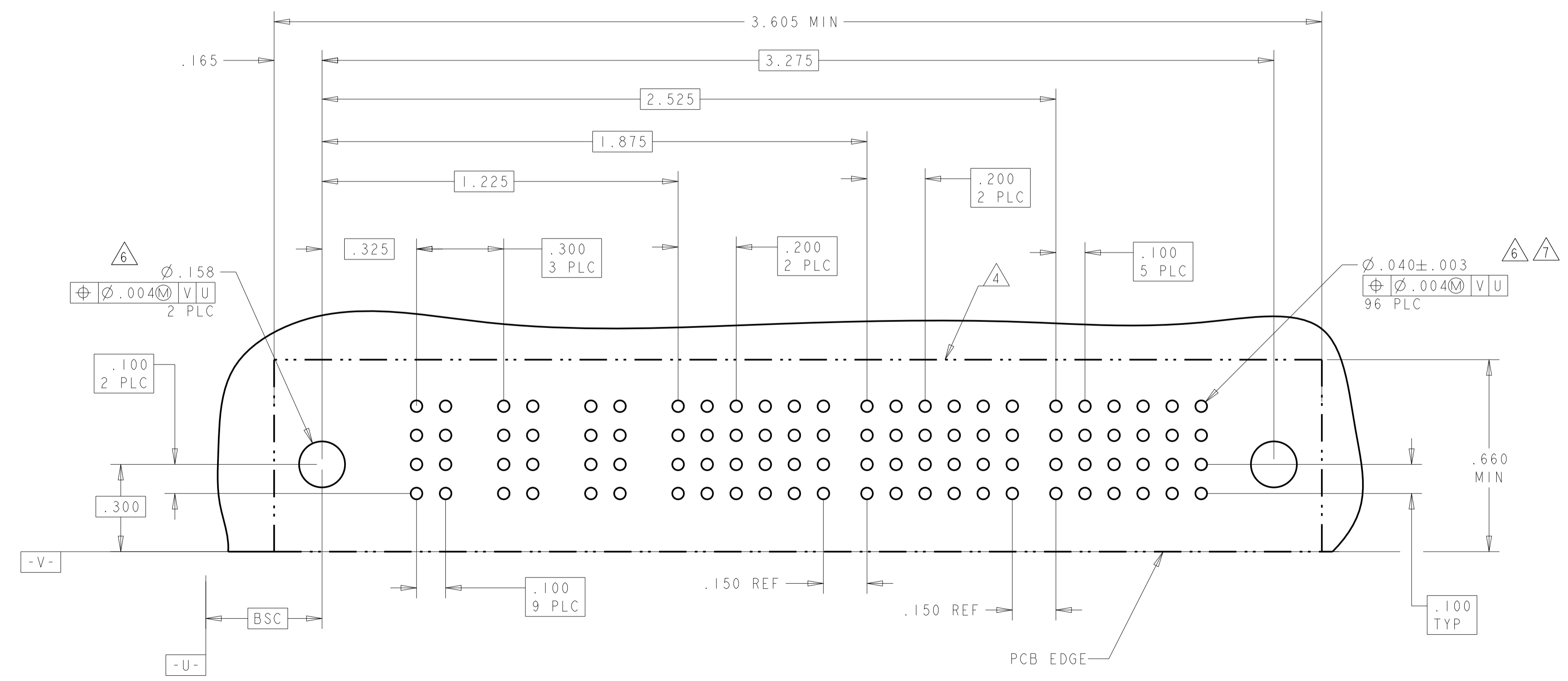
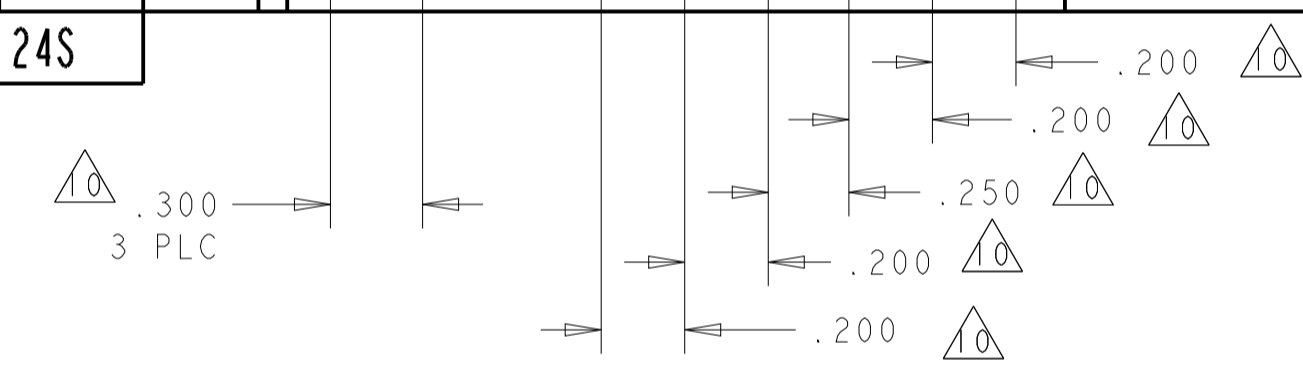

PART NUMBER 6450332-9 & 2-6450332-3 PCB LAYOUT

THIS DRAWING IS A CONTROLLED DOCUMENT.		OWN: R. GRZYBOWSKI 24JAN05	TE Connectivity NAME: RIGHT ANGLE SOLDER HEADER ASSEMBLY MULTI-BEAM XL
DIMENSIONS: INCHES		CHK: M. PERCHERKE 24JAN05	
TOLERANCES UNLESS OTHERWISE SPECIFIED:		APVD: M. PERCHERKE	PRODUCT SPEC: 108-1973
0 PLC ±.01 1 PLC ±.01 2 PLC ±.01 3 PLC ±.005 4 PLC ±.002 ANGLES ±.020		APPLICATION SPEC: 114-13038	RESTRICTED TO: -
MATERIAL: -		FINISH: -	WEIGHT: -
CUSTOMER DRAWING		SCALE: 4:1	SHEET 7 OF 13 REV: H6

LOC	DIST	REVISIONS			
P	LTN	DESCRIPTION	DATE	DMN	APVD
ES	00	SEE SHEET 1			

PART NUMBER	ROWS	POWER					SIGNAL					
		P1	P2	P3	P4	P5	1	2	3	4	5	6
2-6450332-0	D C B A	PM	PM	PM	PM	PM	E	E	E	E	E	E
							K	F	F	F	F	F
							N	G	G	G	G	G
							H	H	H	H	H	S
5P + 24S												

PART NUMBER	ROWS	POWER		SIGNAL					
		P1	P2	1	2	3	4	5	6
6450332-8	D C B A	PM	PM	J	J	J	J	J	J
				K	F	K	K	K	K
				N	N	N	N	N	N
				S	S	S	S	S	S
2P + 24S									

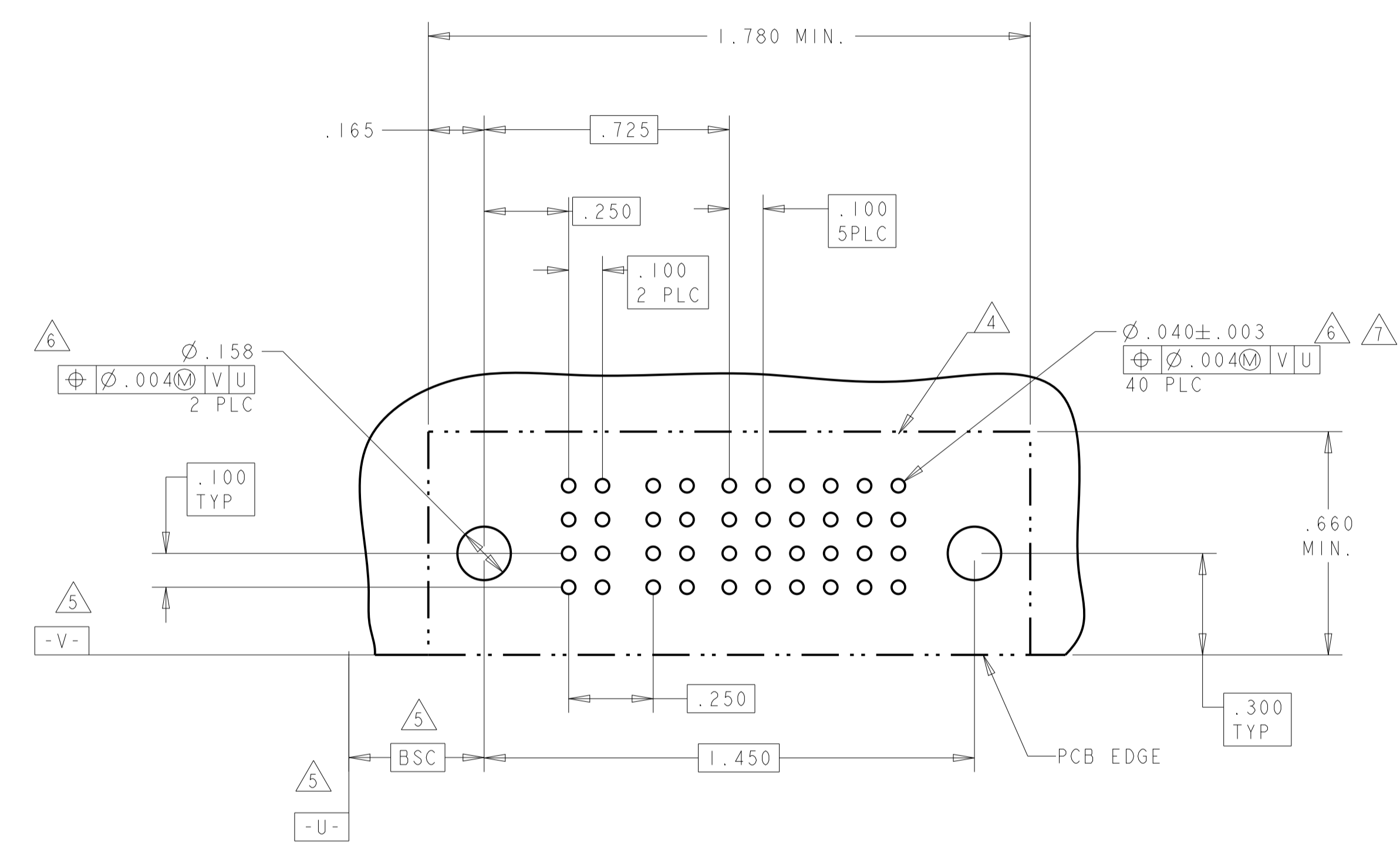
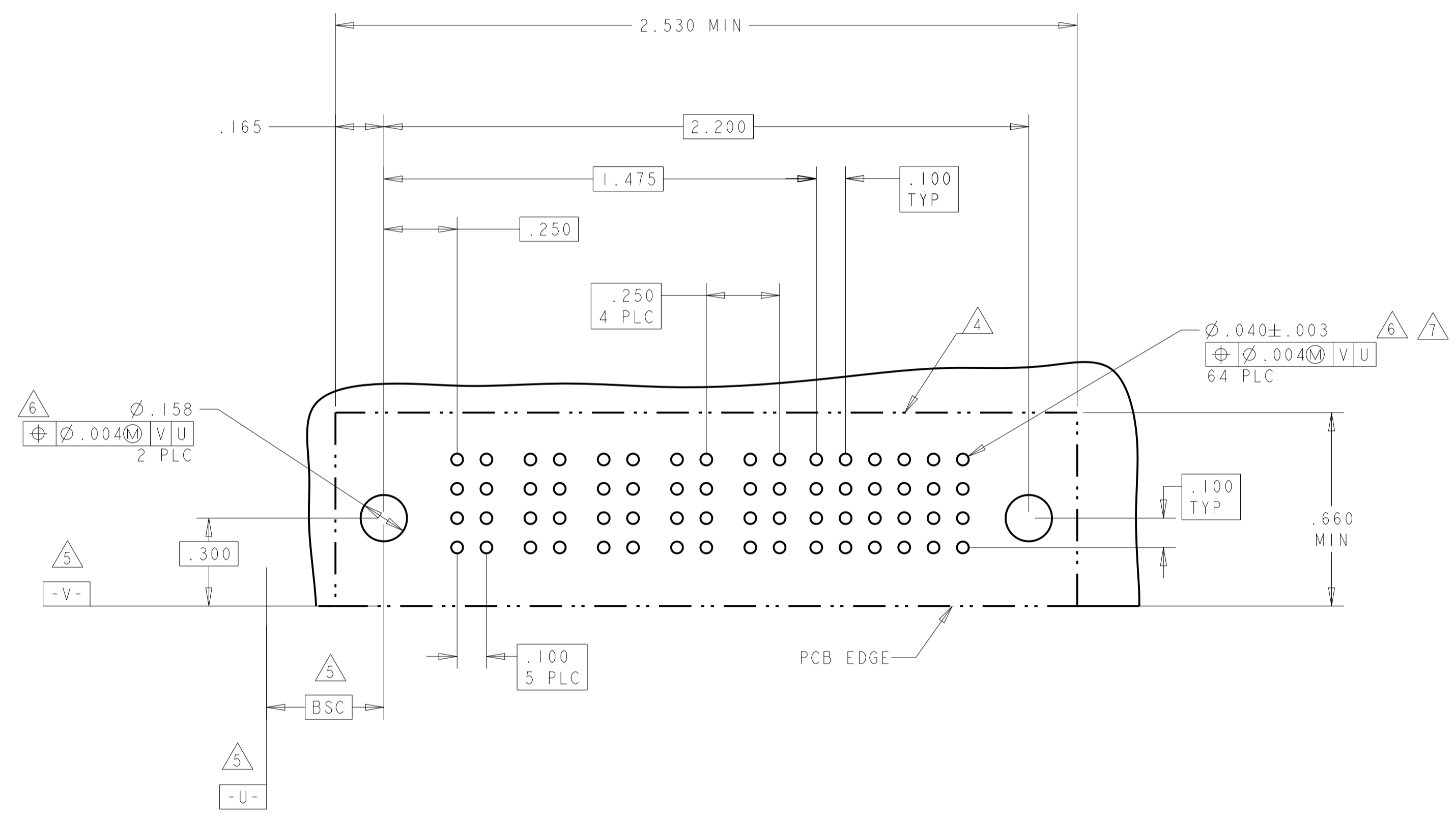

THIS DRAWING IS A CONTROLLED DOCUMENT.

DMN: R. GRZYBOWSKI 24JAN05
CHK: M. PERCHERKE 24JAN05
APVD: M. PERCHERKE

STE TE Connectivity

NAME: RIGHT ANGLE SOLDER HEADER ASSEMBLY MULTI-BEAM XL

PRODUCT SPEC: 108-1973
APPLICATION SPEC: 114-13038

SIZE: A1
CAGE CODE: 100779
DRAWING NO: 6450332

RESTRICTED TO: -

CUSTOMER DRAWING

SCALE: 4:1 SHEET 8 OF 13 REV H6

LOC	DIST	REV	DATE	APPV
ES	00			

PART NUMBER	ROWS	POWER								SIGNAL					
		P1	P2	P3	P4	P5	P6	P7	P8	1	2	3	4	5	6
2-6450332-4	D C B A	PM	PM	PM	PM	PM	PM	PM	PM	J	J	J	J	E	E
		PM	PM	PM	PM	PM	PM	PM	PM	K	K	K	K	F	F
		PM	PM	PM	PM	PM	PM	PM	PM	N	N	N	N	G	G
8P + 24S									S	S	S	S	H	H	

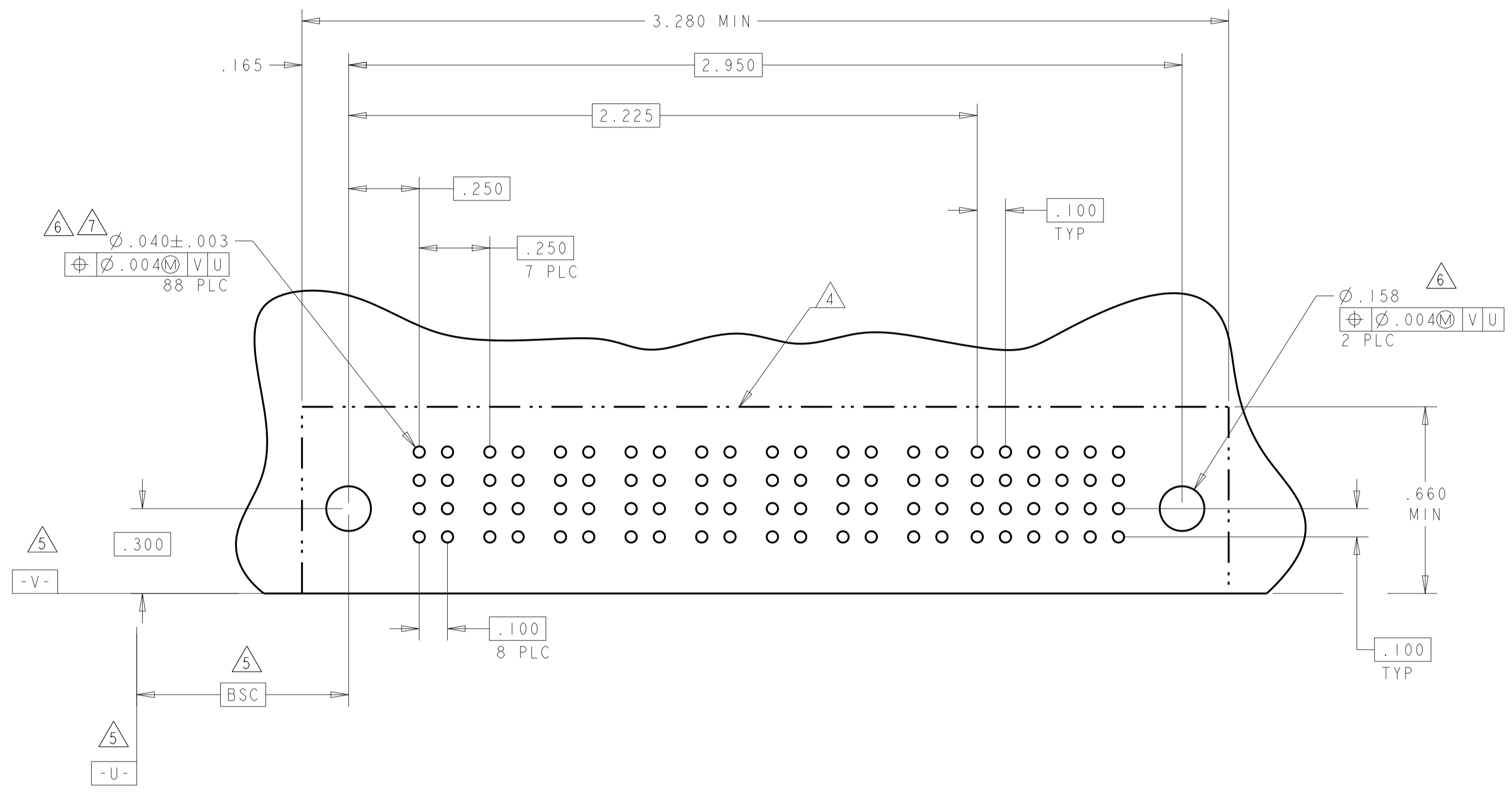

PART NUMBER	ROWS	POWER				SIGNAL					
		P1	P2	P3	P4	1	2	3	4	5	6
2-6450332-5	D C B A	PM	PM	PM	PM	E	E	E	E	E	E
		PM	PM	PM	PM	K	F	F	F	F	F
		PM	PM	PM	PM	N	G	G	G	G	G
4P + 24S						H	H	H	H	H	S

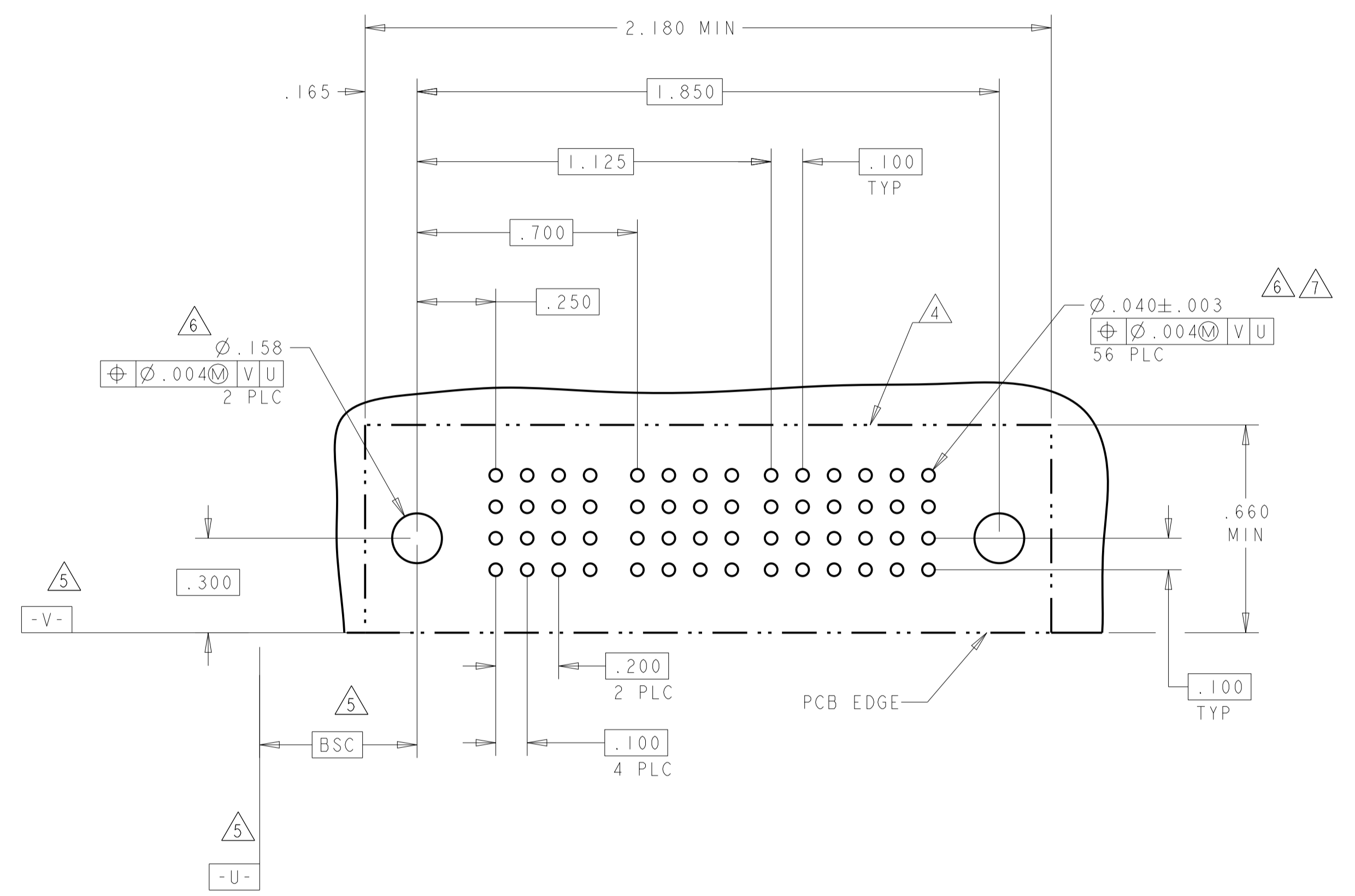

THIS DRAWING IS A CONTROLLED DOCUMENT.

DIMENSIONS: INCHES	TOLERANCES UNLESS OTHERWISE SPECIFIED: 0 PLC ±.01 2 PLC ±.01 3 PLC ±.01 4 PLC ±.005 5 PLC ±.005 ANGLES ±.0020	OWN: R. GRZYBOWSKI CHK: M. PERCHERKE APPV: M. PERCHERKE	24JAN05 24JAN05		TE Connectivity
MATERIAL: -	FINISH: -	NAME: RIGHT ANGLE SOLDER HEADER ASSEMBLY MULTI-BEAM XL	PRODUCT SPEC: 108-1973		SIZE: A100779
CUSTOMER DRAWING		SCALE: 4:1	SHEET: 9 OF 13	REV: H6	

LOC	DIST	REVISIONS					
		P	LTN	DESCRIPTION	DATE	DWN	APVD
ES	00	-	-	SEE SHEET 1	-	-	-

PART NUMBER	ROWS	POWER				SIGNAL					
		P1	P2	P3	P4	1	2	3	4	5	
2-6450332-6	D	PM	PM	PM	PM	J	J	J	J	J	
	C					K	K	K	K	K	K
	B					N	N	N	N	N	N
A						H	H	H	H	H	

4P + 20S

PART NUMBER	ROWS	POWER									SIGNAL							
		P1	P2	P3	P4	P5	P6	P7	P8	P9	1	2	3	4	5	6		
2-6450332-8	D	PM	PM	PM	PM	PM	PM	PM	PM	PM	E	E	E	E	E	E		
	C										K	F	F	F	F	F	F	F
	B										N	G	G	G	G	G	G	G
A											H	H	H	H	H	S		

3ACP + 6P + 24S

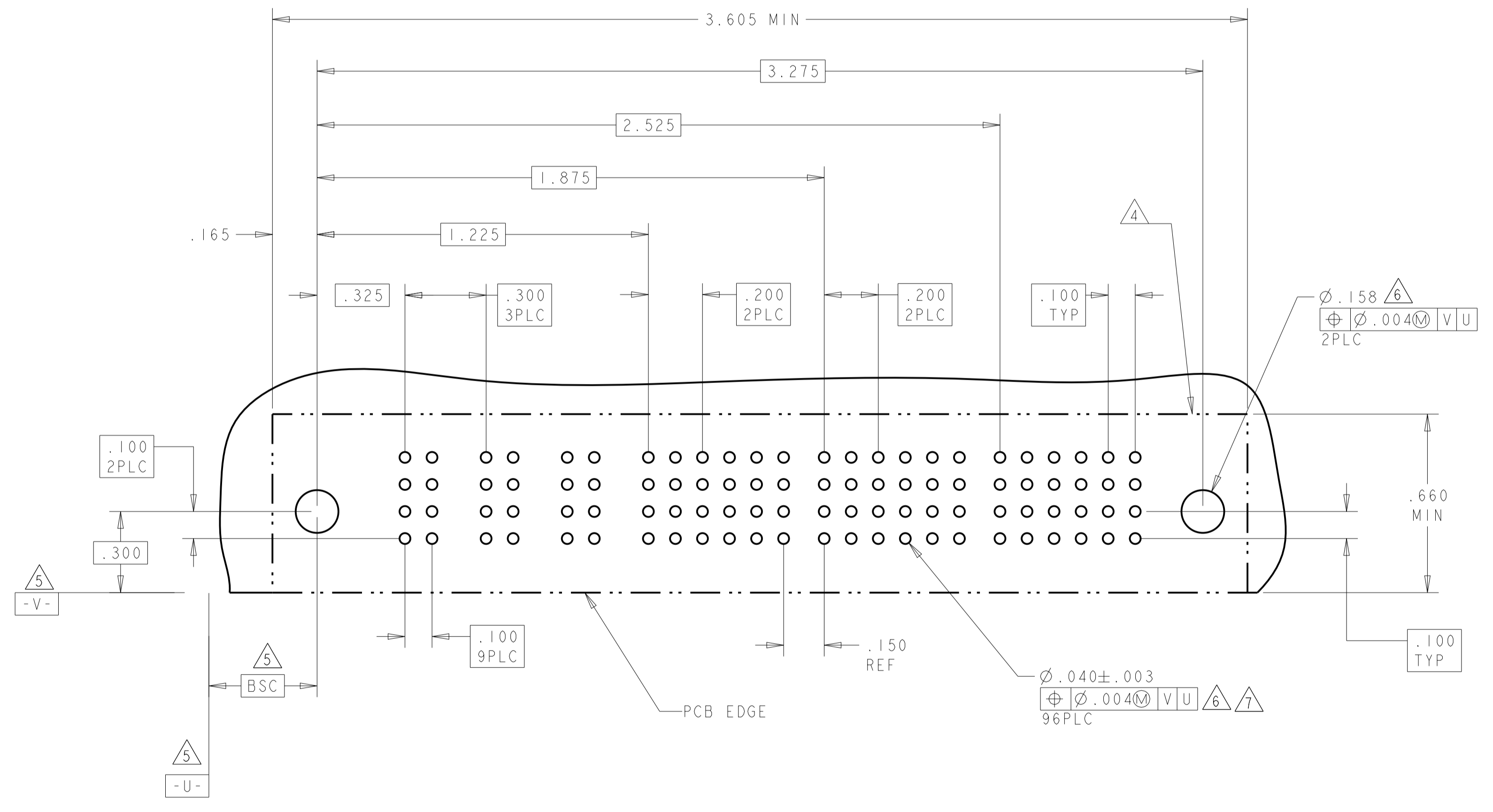
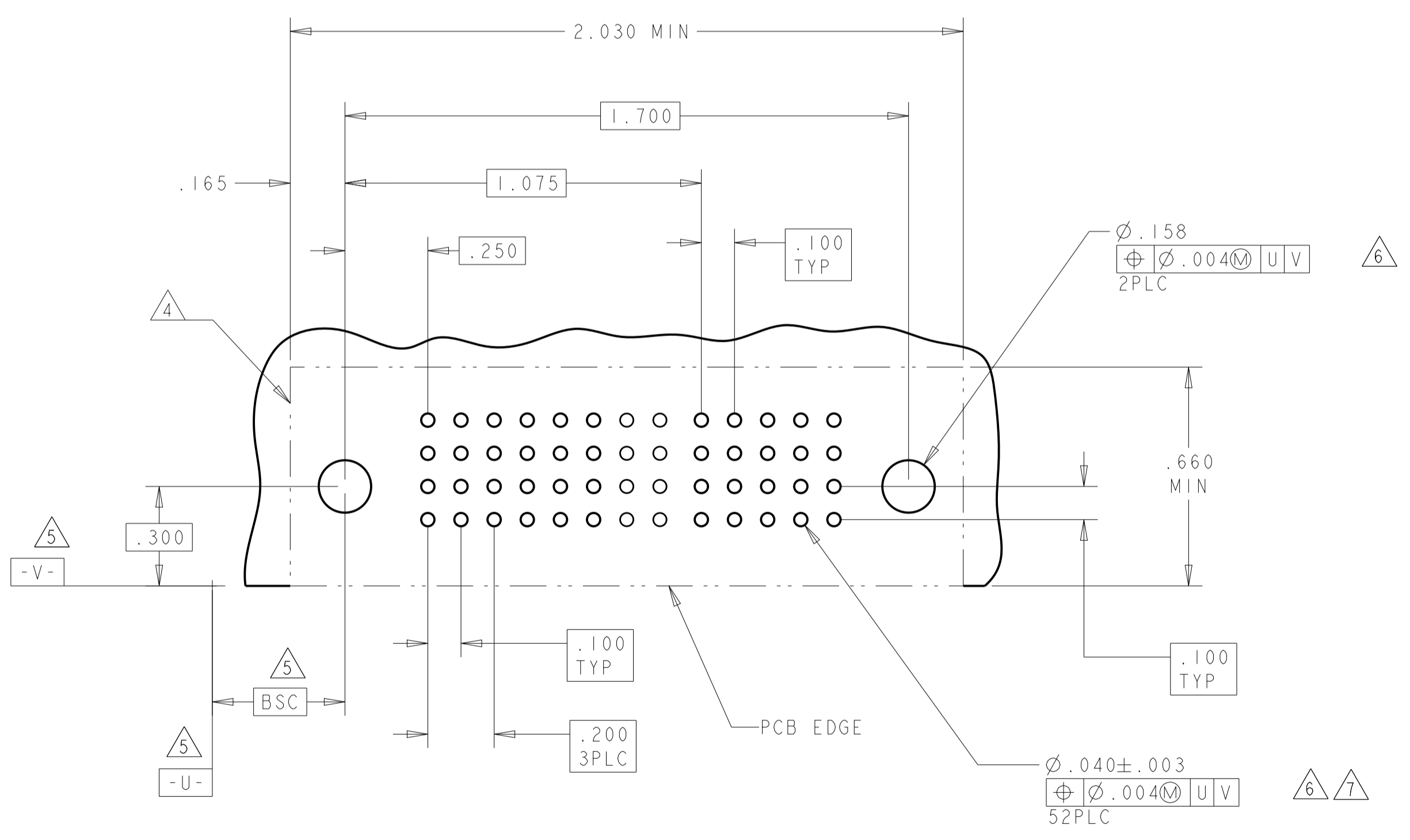

THIS DRAWING IS A CONTROLLED DOCUMENT.

DWN: B. GRZYBOWSKI 24JAN05
CHK: M. PERCHERKE 24JAN05
APVD: M. PERCHERKE

TE Connectivity

NAME: RIGHT ANGLE SOLDER HEADER ASSEMBLY MULTI-BEAM XL

PRODUCT SPEC: 108-1973
APPLICATION SPEC: 114-13038

SIZE: A1
CAGE CODE: 6450332
DRAWING NO: 100779

SCALE: 4:1
SHEET: 10 OF 13
REV: H6

LOC	DIST	REVISIONS			
		REV	DATE	BY	APPV
ES	00	-	-	-	-
		SEE SHEET 1			

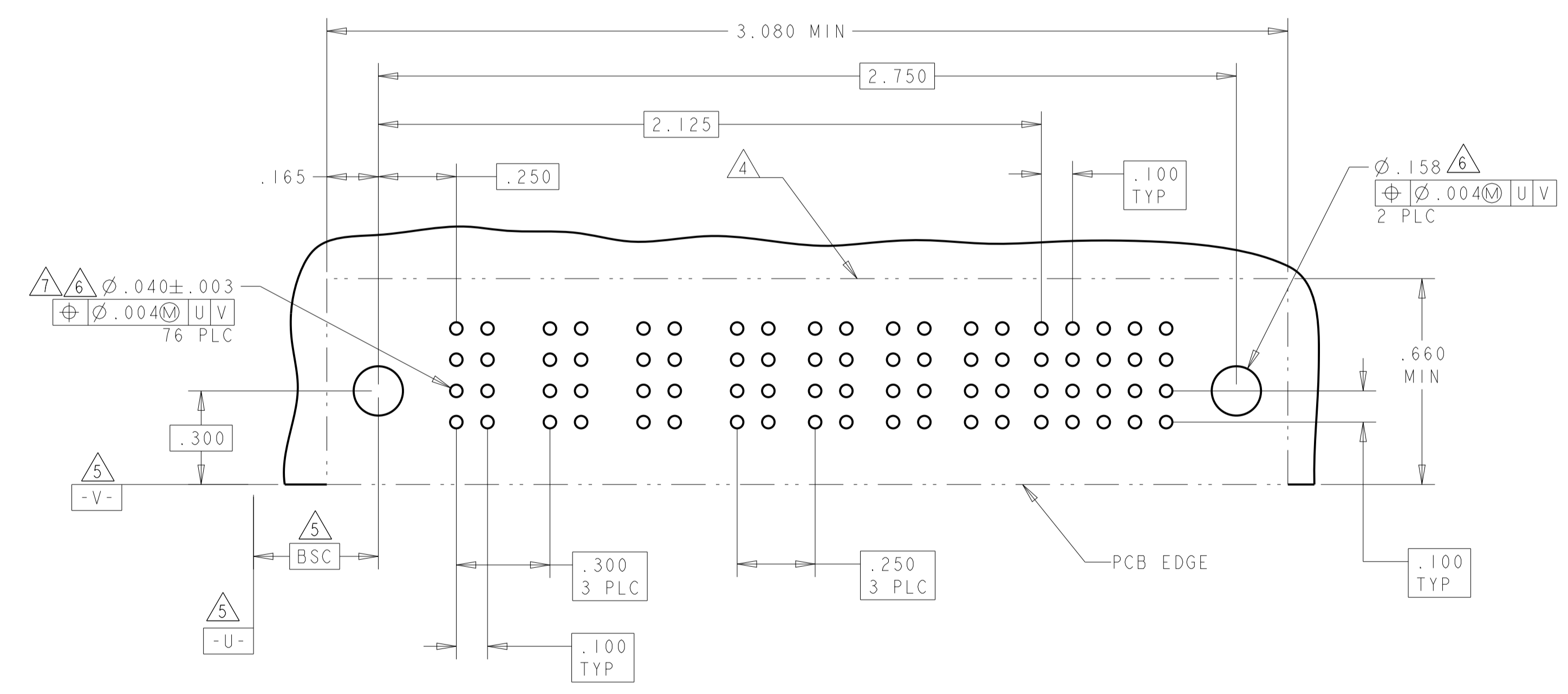
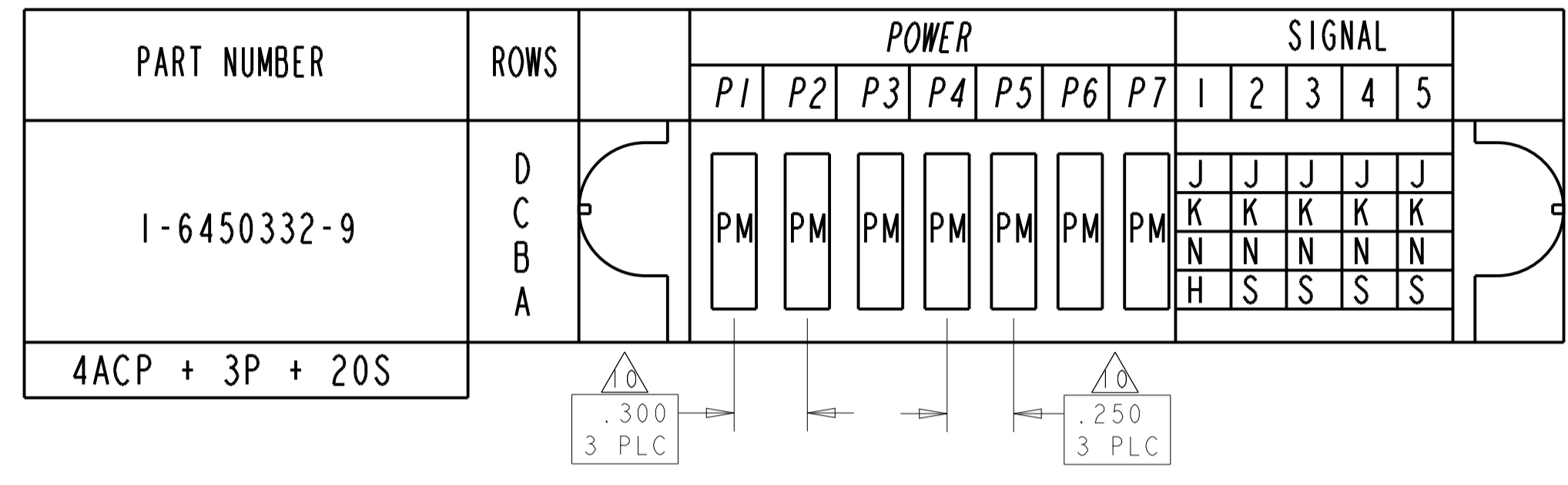

THIS DRAWING IS A CONTROLLED DOCUMENT.		OWN: B. GRZYBOWSKI 24JAN05	TE Connectivity
DIMENSIONS: INCHES		CHK: M. PERCHERKE	
TOLERANCES UNLESS OTHERWISE SPECIFIED: 0 PLC ±. 1 PLC ±.01 2 PLC ±.01 3 PLC ±.005 4 PLC ±.002 ANGLES ±.2°		APVD: M. PERCHERKE	NAME: RIGHT ANGLE SOLDER HEADER ASSEMBLY MULTI-BEAM XL
MATERIAL: -		FINISH: -	RESTRICTED TO: -
CUSTOMER DRAWING		SCALE: 4:1	SHEET 11 OF 13 REV H6

LOC		DIST		REVISIONS			
ES	00	P	LTM	DESCRIPTION	DATE	OWN	APVD
				SEE SHEET 1			

PART NUMBER	ROWS	POWER							SIGNAL						
		P1	P2	P3	P4	P5	P6	P7	P8	P9	1	2	3	4	5
3-6450332-0	D C B A	PM	PM	PM	PM	PM	PM	PM	PM	J	J	J	J	J	J
										K	K	K	K	K	K
										N	N	N	N	N	N
										S	S	S	S	S	S

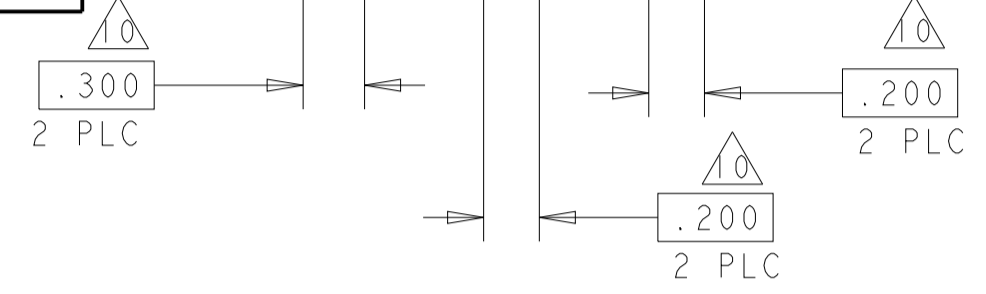

PART NUMBER	ROWS	POWER							SIGNAL					
		P1	P2	P3	P4	P5	P6	P7	1	2	3	4	5	6
3-6450332-1	D C B A	PM	PM	PM	PM	PM	PM	PM	J	J	J	J	J	J
									K	K	K	K	K	K
									N	N	N	N	N	N
									H	S	S	S	S	S

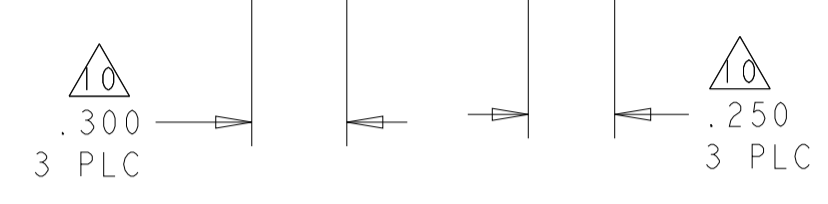

PART NUMBER	ROWS	POWER							SIGNAL					
		P1	P2	P3	P4	P5	P6	P7	1	2	3	4	5	6
3-6450332-3	D C B A	PM	PM	PM	PM	PM	PM	PM	E	E	J	J	J	E
									K	F	F	F	K	F
									N	G	G	G	N	G
									S	H	S	S	H	H

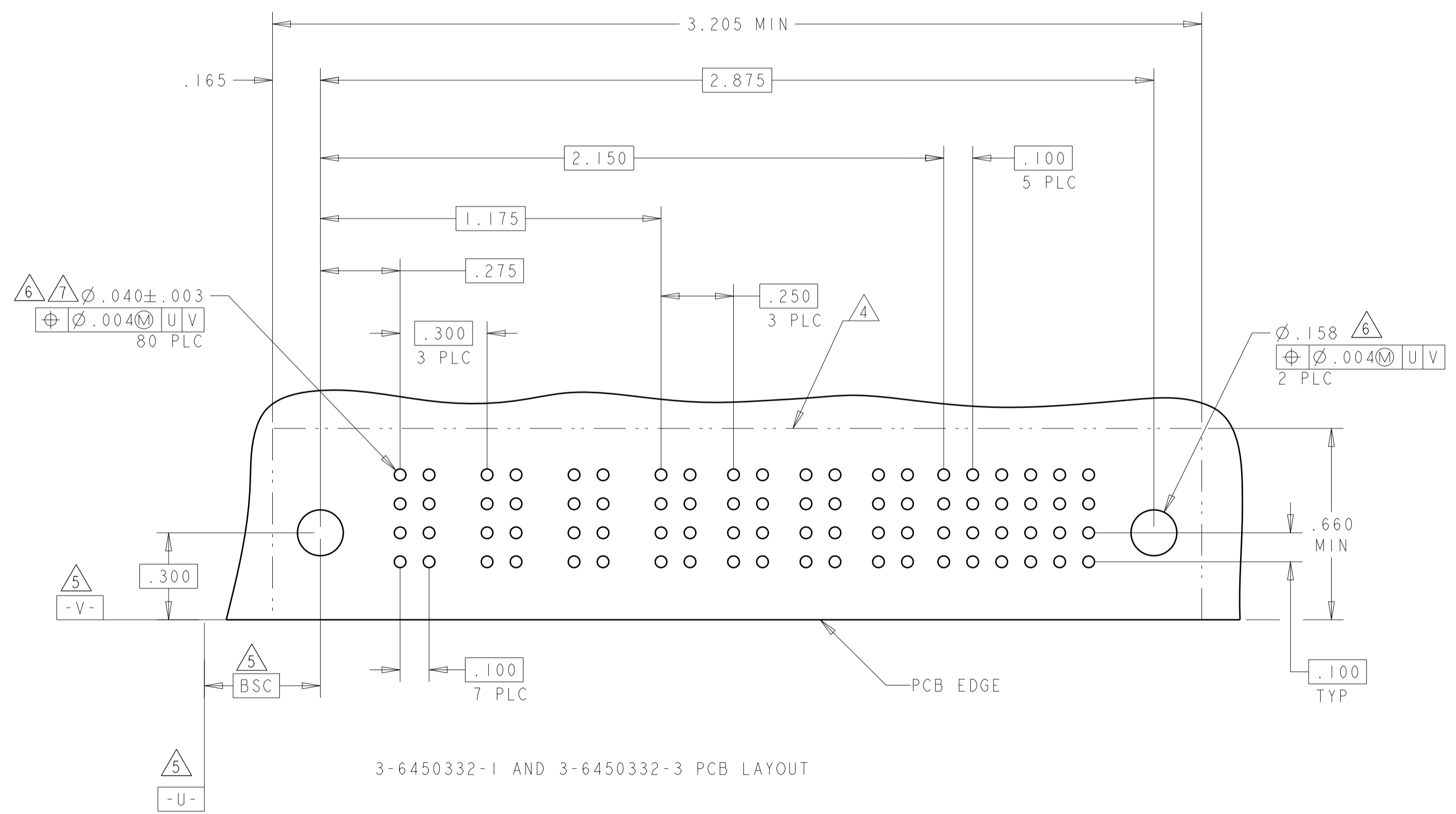
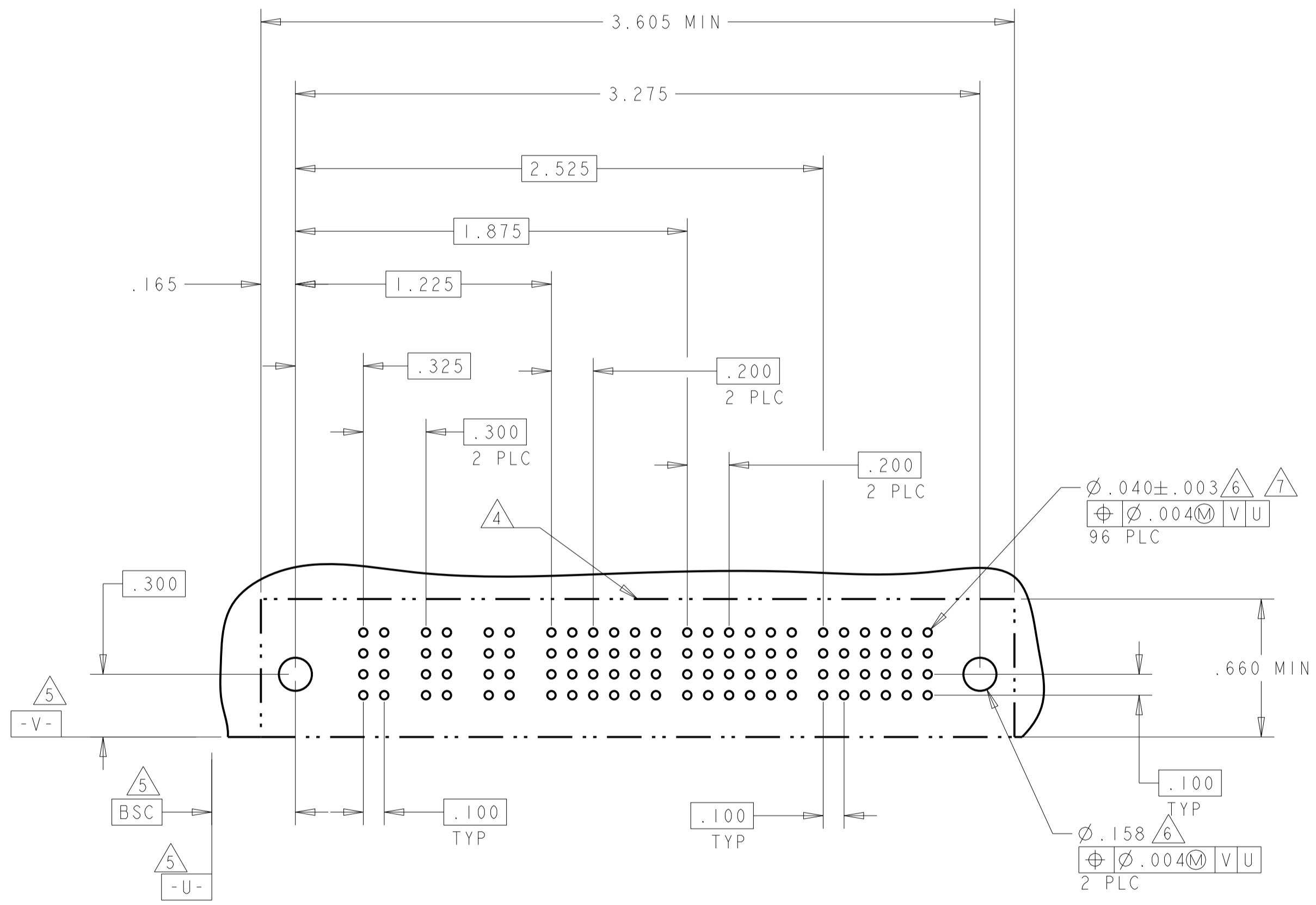
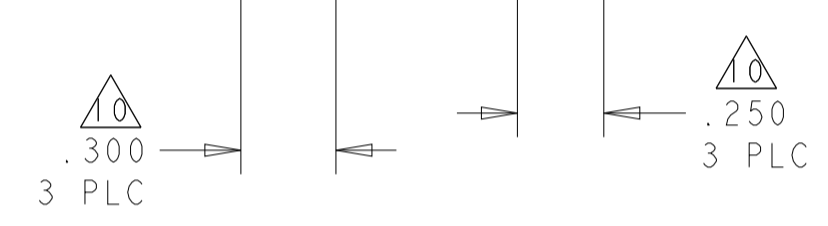

3-6450332-1 AND 3-6450332-3 PCB LAYOUT

THIS DRAWING IS A CONTROLLED DOCUMENT.		OWN: R. GRZYBOWSKI 24JAN05	TE Connectivity
DIMENSIONS: INCHES		CHK: M. PERCHERKE 24JAN05	
TOLERANCES UNLESS OTHERWISE SPECIFIED:		APVD: M. PERCHERKE	NAME: RIGHT ANGLE SOLDER HEADER ASSEMBLY MULTI-BEAM XL
0 PLC ±.01		PRODUCT SPEC: 108-1973	SIZE: CAGE CODE DRAWING NO: A100779
1 PLC ±.01		APPLICATION SPEC: 114-13038	RESTRICTED TO: -
2 PLC ±.01		WEIGHT: -	SCALE: 4:1
3 PLC ±.005		CUSTOMER DRAWING	SHEET 12 OF 13
4 PLC ±.002			REV: H6
ANGLES ±.0020			
FINISH: -			

LOC	DIST	REV	DATE	BY	APPD
ES	00				
DESCRIPTION			DATE	BY	APPD
SEE SHEET 1					

PART NUMBER	ROWS	POWER				SIGNAL		
		P1	P2	P3	P4	1	2	3
3-6450332-2	D C B A	PM	PM	PM	PM	J K N S	E F N S	J F N S
4P + 12S								

PART NUMBER	ROWS	POWER				SIGNAL					
		P1	P2	P3	P4	1	2	3	4	5	6
3-6450332-4	D C B A	PM	PM	PM	PM	E K N S	E F G H	J F G S	J F G S	J K N S	E F G H
4P + 24S											

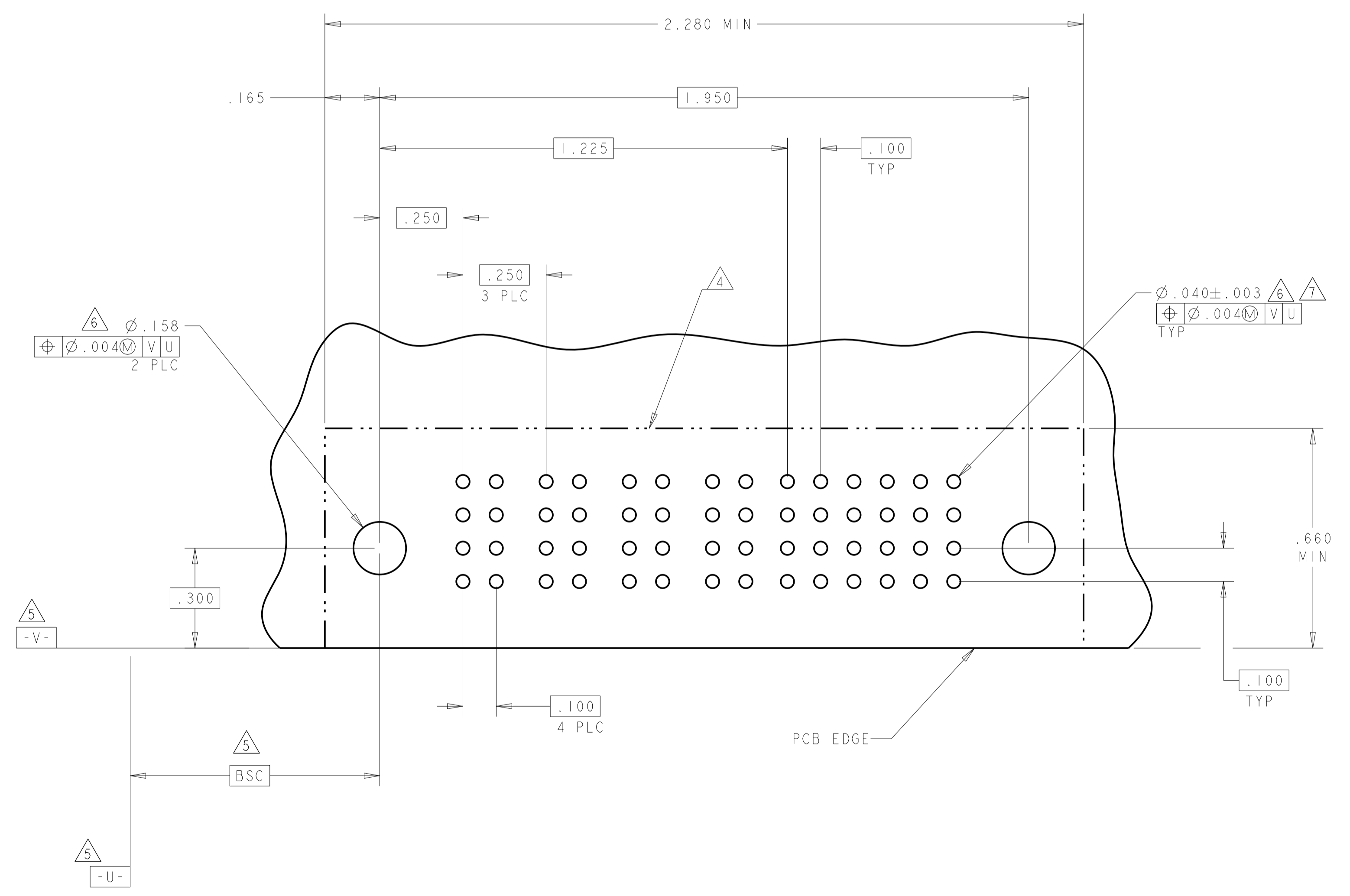
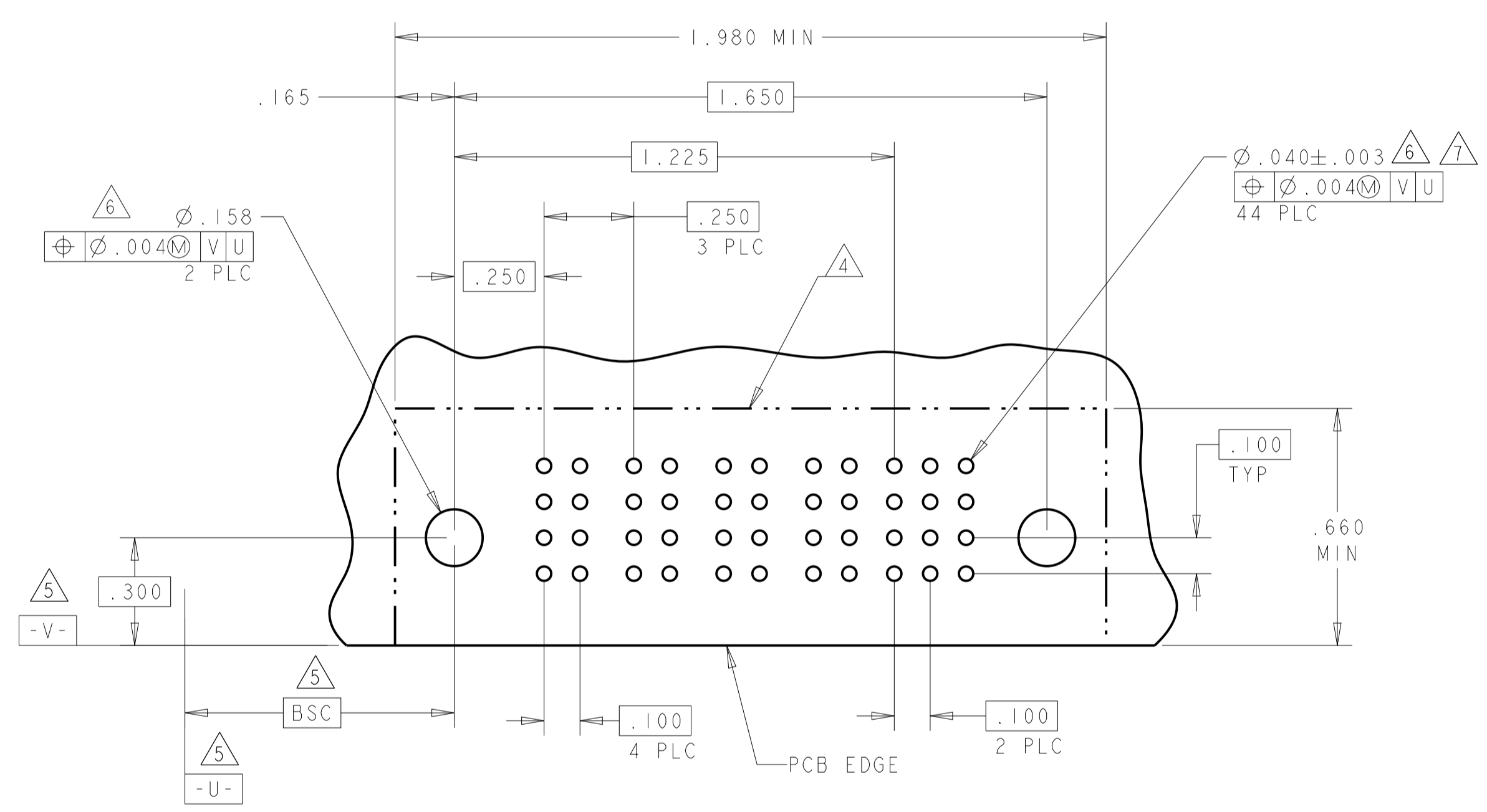

THIS DRAWING IS A CONTROLLED DOCUMENT.		OWN: R. GRZYBOWSKI 24JAN05	TE Connectivity												
DIMENSIONS: INCHES		CHK: M. PERCHERKE 24JAN05													
TOLERANCES UNLESS OTHERWISE SPECIFIED:		APVD: M. PERCHERKE	NAME: RIGHT ANGLE SOLDER HEADER ASSEMBLY MULTI-BEAM XL												
<table border="1"> <tr> <td>0 PLC</td> <td>± .01</td> </tr> <tr> <td>1 PLC</td> <td>± .01</td> </tr> <tr> <td>2 PLC</td> <td>± .01</td> </tr> <tr> <td>3 PLC</td> <td>± .005</td> </tr> <tr> <td>4 PLC</td> <td>± .002</td> </tr> <tr> <td>ANGLES</td> <td>± .002</td> </tr> </table>		0 PLC	± .01	1 PLC	± .01	2 PLC	± .01	3 PLC	± .005	4 PLC	± .002	ANGLES	± .002	PRODUCT SPEC: 108-1973	SIZE: A100779
0 PLC	± .01														
1 PLC	± .01														
2 PLC	± .01														
3 PLC	± .005														
4 PLC	± .002														
ANGLES	± .002														
MATERIAL: -		APPLICATION SPEC: 114-13038	DRAWING NO: C=6450332												
FINISH: -		WEIGHT: -	RESTRICTED TO: -												
CUSTOMER DRAWING		SCALE: 4:1	SHEET 13 OF 13 REV: H6												



Компания «ЭлектроПласт» предлагает заключение долгосрочных отношений при поставках импортных электронных компонентов на взаимовыгодных условиях!

Наши преимущества:

- Оперативные поставки широкого спектра электронных компонентов отечественного и импортного производства напрямую от производителей и с крупнейших мировых складов;
- Поставка более 17-ти миллионов наименований электронных компонентов;
- Поставка сложных, дефицитных, либо снятых с производства позиций;
- Оперативные сроки поставки под заказ (от 5 рабочих дней);
- Экспресс доставка в любую точку России;
- Техническая поддержка проекта, помощь в подборе аналогов, поставка прототипов;
- Система менеджмента качества сертифицирована по Международному стандарту ISO 9001;
- Лицензия ФСБ на осуществление работ с использованием сведений, составляющих государственную тайну;
- Поставка специализированных компонентов (Xilinx, Altera, Analog Devices, Intersil, Interpoint, Microsemi, Aeroflex, Peregrine, Syfer, Eurofarad, Texas Instrument, Miteq, Cobham, E2V, MA-COM, Hittite, Mini-Circuits, General Dynamics и др.);

Помимо этого, одним из направлений компании «ЭлектроПласт» является направление «Источники питания». Мы предлагаем Вам помощь Конструкторского отдела:

- Подбор оптимального решения, техническое обоснование при выборе компонента;
- Подбор аналогов;
- Консультации по применению компонента;
- Поставка образцов и прототипов;
- Техническая поддержка проекта;
- Защита от снятия компонента с производства.



Как с нами связаться

Телефон: 8 (812) 309 58 32 (многоканальный)

Факс: 8 (812) 320-02-42

Электронная почта: org@eplast1.ru

Адрес: 198099, г. Санкт-Петербург, ул. Калинина, дом 2, корпус 4, литера А.