

10-ohm 0.5%, 1%, 2%, 5% tolerance thick film current sense resistor



features

- Marking: 1H: no marking on black protective coating
1E, 1J: No marking on indigo protective coating.
2A~W3A: three or four digit marking on indigo protective coating.
- Products with lead-free terminations meet EU RoHS requirements. EU RoHS regulation is not intended for Pb-glass contained in electrode, resistor element and glass.
- AEC-Q200 Qualified: 0402 (1E), 0603 (1J), 0805 (2A), 1206 (2B), 1210 (2E), 2010 (2H/W2H), 2512 (3A/W3A)

dimensions and construction

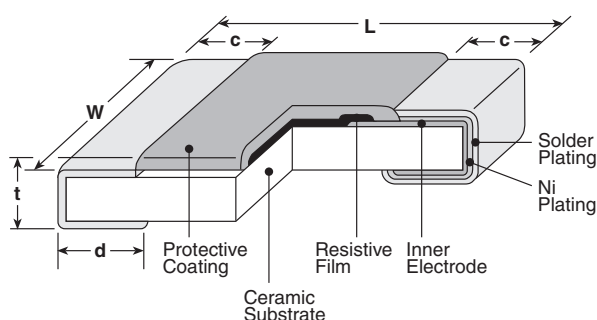

Type (Inch Size Code)	Dimensions inches (mm)				
	L	W	c	d	t
1H (0201)	.024±.001 (0.6±0.03)	.012±.001 (0.3±0.03)	.004±.002 (0.1±0.05)	.006±.002 (0.15±0.05)	.009±.001 (0.23±0.03)
1E (0402)	.039 ^{+0.04} _{-0.002} (1.0 ^{+0.1} _{-0.05})	.02 ^{+0.04} _{-0.002} (0.5 ^{+0.1} _{-0.05})	.01±.004 (0.25±0.1)	.01±.004 (0.25±0.1)	.014±.002 (0.35±0.05)
1J (0603)	.063±.008 (1.6±0.2)	.031 ^{+0.006} _{-0.004} (0.8 ^{+0.15} _{-0.1})	.014±.004 (0.35±0.1)	.014±.004 (0.35±0.1)	.018±.004 (0.45±0.1)
2A (0805)	.079±.008 (2.0±0.2)	.049±.004 (1.25±0.1)	.016±.008 (0.4±0.2)	.012 ^{+0.008} _{-0.004} (0.3 ^{+0.2} _{-0.1})	.02±.004 (0.5±0.1)
2B (1206)	.126±.008 (3.2±0.2)	.063±.008 (1.6±0.2)	.02±.012 (0.5±0.3)	.016 ^{+0.008} _{-0.004} (0.4 ^{+0.2} _{-0.1})	.024±.004 (0.6±0.1)
2E (1210)		.102±.008 (2.6±0.2)			
2H (2010)		.098±.008 (2.5±0.2)			
W2H (2010)	.197±.008 (5.0±0.2)	.098±.008 (2.5±0.2)		.026±.006 (0.65±0.15)	
3A (2512)	.248±.008 (6.3±0.2)	.122±.008 (3.1±0.2)		.016 ^{+0.008} _{-0.004} (0.4 ^{+0.2} _{-0.1})	
W3A (2512)				.026±.006 (0.65±0.15)	

ordering information

New Part #	SR73	2B	T	TD	1R00	F
Type		Size	Termination Material	Packaging	Nominal Resistance	Tolerance
		1H 1E 1J 2A 2B 2E W2H W3A 2H 3A	T: Sn L: SnPb (1E, 1J, 2A, 2B, 2E, 2H, 3A) G: Au (1J, 2A, 2B: 0.1Ω - 10Ω - contact factory)	TCM: 0201 only: 7" 2mm pitch pressed paper TPL:0402 only: 2mm pitch punch paper TP: 0402, 0603, 0805: 7" 2mm pitch punch paper TD: 0603, 0805, 1206, 1210: 7" 4mm pitch punched paper TDD: 0603, 0805, 1206, 1210: 10" paper tape TE: 0805, 1206, 1210, 2010 & 2512: 7" embossed plastic TED: 0805, 1206, 1210, 2010 & 2512: 10" embossed plastic For further information on packaging, please refer to Appendix A	±2%, ±5%: 2 significant figures + 1 multiplier "R" indicates decimal on value <10Ω ±1%: 3 significant figures + 1 multiplier "R" indicates decimal on value <100Ω All values less than 0.1Ω (100mΩ) are expressed in mΩ with "L" as decimal Example: 20mΩ = 20L (3-digit)	D: ±0.5% F: ±1% G: ±2% J: ±5%

Specifications given herein may be changed at any time without prior notice. Please confirm technical specifications before you order and/or use.

12/16/14

applications and ratings

Part Designation*	Power Rating @ 70°C	T.C.R. (ppm/°C) Max.	Resistance Range				Absolute Maximum Working Voltage	Maximum Overload Voltage (5 Secs. Max.)	Rated Terminal Part Temp.	Operating Temp. Range
			E-24, E-96 (D±0.5%)	E-24, E-96 (F±1%)	E-24 (G±2%)	E-24 (J±5%)				
SR731H (0201)	0.1W	0 - ±500	—	—	—	0.18Ω - 0.24Ω	1.0V	2.5V	125°C	-55°C to +125°C
		0 - ±400	—	1Ω - 10Ω**	—	0.27Ω - 10Ω				
SR731E (0402)	1/8W (.125W) 1/6W (.166W ¹)	±200	—	0.51Ω - 10Ω**	0.51Ω - 10Ω	0.51Ω - 10Ω	1.11V	2.79V		
		±250	—	0.2Ω - 0.47Ω**	0.2Ω - 0.47Ω	0.2Ω - 0.47Ω				
		±300	—	0.1Ω - 0.18Ω**	0.1Ω - 0.18Ω	0.1Ω - 0.18Ω				
SR731J (0603)	1/5W (.2W)	±200	—	0.1Ω - 10Ω	0.1Ω - 10Ω	0.1Ω - 10Ω	1.41V	3.53V		
SR732A (0805)	1/4W (.25W) 1/3W (.33W ¹)	±100	0.15Ω - 10Ω	0.1Ω - 10Ω	—	—	1.58V	3.95V		
		±200	—	—	0.1Ω - 10Ω	0.1Ω - 10Ω				
		±500	—	—	—	0.051Ω - 0.091Ω				
		±800	—	—	—	0.030Ω - 0.047Ω				
SR732B (1206)	1/3W (.33W) 1/2W (.5W ¹)	±100	0.15Ω - 10Ω	0.1Ω - 10Ω	—	—	1.81V	4.54V		
		±200	—	—	0.1Ω - 10Ω	0.1Ω - 10Ω				
		±500	—	—	—	0.056Ω - 0.091Ω				
		±800	—	—	—	0.030Ω - 0.051Ω				
SR732E (1210)	1/2W (.5W) 2/3W (.66W ¹)	±100	—	0.1Ω - 10Ω	—	—	2.23V	5.59V		
		±200	—	—	0.1Ω - 10Ω	0.047Ω - 10Ω				
		±500	—	—	—	0.036Ω - 0.043Ω				
		±1000	—	—	—	0.024Ω - 0.033Ω				
SR732H/W2H ² (2010)	3/4W (.75W)	±100	—	0.1Ω - 10Ω	—	—	2.73V	6.84V		
		±200	—	—	0.1Ω - 10Ω	0.1Ω - 10Ω				
		±500	—	—	—	0.056Ω - 0.091Ω				
		±800	—	—	—	0.033Ω - 0.051Ω				
SR733A/W3A (2512)	1W	±100	—	0.1Ω - 10Ω	—	—	3.16V	7.90V		
		±200	—	—	0.1Ω - 10Ω	0.1Ω - 10Ω				
		±500	—	—	—	0.056Ω - 0.091Ω				
		±800	—	—	—	0.039Ω - 0.051Ω				

* Parentheses indicate EIA package size codes.

** 1H, 1E (F: ±1%) E-24 values only.

¹ Please refer to the "Higher Power Ratings" statement in the beginning of the catalog. Contact KOA prior to usage.

² SR73W3AS (2010 size, 1 Watt) with limited Resistance Range - contact factory for details.

Rated ambient temperature: +70°C

Rated voltage = $\sqrt{\text{Power rating} \times \text{resistance value}}$ or max. working voltage, whichever is lower

environmental applications

Derating Curve



For resistors operated at an ambient temperature of 70°C or above, a power rating shall be derated in accordance with the derating curve.



For resistors operated at a terminal part temperature of described for each size or above, a power rating shall be derated in accordance with the derating curve.

Please refer to "Introduction of the derating curve based on the terminal part temperature" on the beginning of our catalog before use.

Performance Characteristics

Parameter	Requirement $\Delta R \pm(\%+0.005\Omega)$		Test Method
	Limit	Typical	
Resistance	Within specified tolerance	—	25°C
T.C.R.	Within specified T.C.R.	—	+25°C/-55°C and +25°C/+125°C
Overload (Short time)	±2%	±0.5%	Rated voltage x 2.5 for 5 seconds
Resistance to Solder Heat	1H: ±3%, 1E-W3A: ±1%	1H: ±0.75% 1E-W3A: ±0.3%	260°C ± 5°C, 10 seconds ± 1 second
Rapid Change of Temperature	±1%	±0.3%	-40°C (30 minutes), +125°C (30 minutes), 100 cycles
Moisture Resistance	1H: ±3% 1E-W3A: ±2%	±1%	40°C ± 2°C, 90%-95% RH, 1000 hours, 1.5 hr ON, 0.5 hr OFF cycle
Endurance at 70°C	1H: ±3% 1E-W3A: ±2%	±1%	70°C ± 2°C, 1000 hours, 1.5 hr ON, 0.5 hr OFF cycle
High Temperature Exposure	±1%	±0.3%	1H: +125°C, 1000 hours; 1E, 1J, 2A, 2B, 2E, 2H/W2H, 3A/W3A: +150°C, 1000 hours

Specifications given herein may be changed at any time without prior notice. Please confirm technical specifications before you order and/or use.

12/05/14



Компания «ЭлектроПласт» предлагает заключение долгосрочных отношений при поставках импортных электронных компонентов на взаимовыгодных условиях!

Наши преимущества:

- Оперативные поставки широкого спектра электронных компонентов отечественного и импортного производства напрямую от производителей и с крупнейших мировых складов;
- Поставка более 17-ти миллионов наименований электронных компонентов;
- Поставка сложных, дефицитных, либо снятых с производства позиций;
- Оперативные сроки поставки под заказ (от 5 рабочих дней);
- Экспресс доставка в любую точку России;
- Техническая поддержка проекта, помощь в подборе аналогов, поставка прототипов;
- Система менеджмента качества сертифицирована по Международному стандарту ISO 9001;
- Лицензия ФСБ на осуществление работ с использованием сведений, составляющих государственную тайну;
- Поставка специализированных компонентов (Xilinx, Altera, Analog Devices, Intersil, Interpoint, Microsemi, Aeroflex, Peregrine, Syfer, Eurofarad, Texas Instrument, Miteq, Cobham, E2V, MA-COM, Hittite, Mini-Circuits, General Dynamics и др.);

Помимо этого, одним из направлений компании «ЭлектроПласт» является направление «Источники питания». Мы предлагаем Вам помощь Конструкторского отдела:

- Подбор оптимального решения, техническое обоснование при выборе компонента;
- Подбор аналогов;
- Консультации по применению компонента;
- Поставка образцов и прототипов;
- Техническая поддержка проекта;
- Защита от снятия компонента с производства.



Как с нами связаться

Телефон: 8 (812) 309 58 32 (многоканальный)

Факс: 8 (812) 320-02-42

Электронная почта: org@eplast1.ru

Адрес: 198099, г. Санкт-Петербург, ул. Калинина, дом 2, корпус 4, литера А.