

Cree® PLCC6 3 in 1 SMD LED CLX6F-GKB

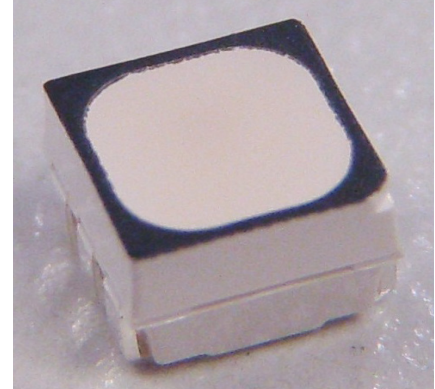

PRODUCT DESCRIPTION

These SMD LEDs are packaged in an industry standard PLCC6 package. These high reliability and high brightness LEDs are designed to work in a wide range of environmental condition and are ideally suited for use in illumination applications.

Its wide viewing angle makes these LEDs ideally suited for channel letter, or general backlighting and illumination applications. The flat top emitting surface makes it easy for these LEDs to mate with light pipes.

FEATURES

- Size (mm): 3.5 x 3.4 x 2.8
- Dominant Wavelength: Green (520 - 540nm)
- Luminous Intensity (mcd) Green (5020-9000)
- Water-Resistant (IPX8)*
- Moisture Sensitivity Level: 5a
- Lead-Free
- RoHS Compliant
- Matte Surface

APPLICATIONS

- Architecture Lighting
- Channel Letter
- Backlight

*: This part is tested under the condition of assembling it on a PCB with isolating the electrical path by silicone. The leads area of the LED is not IPx8 rated and it's required to insulate for moisture by customer in outdoor application.

ABSOLUTE MAXIMUM RATINGS ($T_A = 25^\circ\text{C}$)

Items	Symbol	Absolute Maximum Rating	Unit
Forward Current ^{Note 1}	I_F	3 x 35	mA
Peak Forward Current ^{Note 2}	I_{FP}	3 x 100	mA
Reverse Voltage	V_R	5	V
Power Dissipation	P_D	3 x 126	mW
Operation Temperature	T_{opr}	-40 ~ +85	$^\circ\text{C}$
Storage Temperature	T_{stg}	-40 ~ +100	$^\circ\text{C}$
Junction Temperature	T_J	110	$^\circ\text{C}$
Junction/ambient 1 chip on	R_{THJA}	400	$^\circ\text{C}/\text{W}$
Junction/solder point 1 chip on	R_{THJS}	230	$^\circ\text{C}/\text{W}$
Electrostatic Discharge Classification(MIL-STD-883E)	ESD	1000 V	

Note: 1.Single-color light.
2.Pulse width ≤ 0.1 msec, duty $\leq 1/10$.

TYPICAL ELECTRICAL & OPTICAL CHARACTERISTICS ($T_A = 25^\circ\text{C}$)

Characteristics	Condition	Symbol	Values	Unit
Dominant Wavelength	$I_F = 3 \times 20$ mA	λ_{DOM}	520~540	nm
Spectral bandwidth at 50% I_{REL} max	$I_F = 3 \times 20$ mA	$\Delta \lambda$	28	nm
Forward Voltage	$I_F = 3 \times 20$ mA	$V_{F(avg)}$	2.9	V
		$V_{F(max)}$	3.6	V
Luminous Intensity	$I_F = 3 \times 20$ mA	$I_{V(min)}$	5020	mcd
		$I_{V(avg)}$	7100	mcd
Luminous Flux(Reference)	$I_F = 3 \times 20$ mA	$\Phi_{V(avg)}$	19.6	lm
Reverse Current (max)	$V_R = 5$ V	I_R	10	μA

Note: Continuous reverse voltage can cause LED damage.

INTENSITY BIN LIMIT ($I_F = 3 \times 20 \text{ mA}$)

Green

Bin Code	Min.(mcd)	Max.(mcd)
1h1j	5020	6300
W	5600	7100
1k1m	6300	8000
X	7100	9000

Tolerance of measurement of luminous intensity is $\pm 10\%$.

COLOR BIN LIMIT ($I_F = 3 \times 20 \text{ mA}$)

Green

Bin Code	Min.(nm)	Max.(nm)
G7	520	525
G23	522.5	527.5
G8	525	530
G45	527.5	532.5
G9	530	535
G67	532.5	537.5
Ga	535	540

Tolerance of measurement of dominant wavelength is $\pm 1 \text{ nm}$.

ORDER CODE TABLE*

Kit Number	Color	Luminous Intensity (mcd)		Dominant Wavelength (nm)				Package
		Min.	Max.	Color Bin	Min. (nm)	Color Bin	Max. (nm)	
CLX6F-GKB-C1h1jX7a3	Green	5020	9000	G7	520	Ga	540	Reel
CLX6F-GKB-C1h1j17D3	Green	Any 1 Intensity bin from 1h1j(5020) - X(9000)		Any 1 hue bin from G7(520) - Ga(540)				Reel

Notes:

1. The above kit numbers represent the order codes which include multiple intensity-bin and color-bin codes. Only one intensity-bin code and one color-bin code will be shipped on each reel. Single intensity-bin code and single color-bin code will be orderable in certain quantities. For example, any 1 intensity bin from 1h1j - X means only 1 intensity bin (1h1j or W or 1k1m or X) will be shipped by Cree. For example, any 1 color bin from G7 - Ga means only 1 color bin (G7 or G23 or G8 or G45 or G9 or G67 or Ga) will be shipped by Cree.
2. Please refer to the "Cree LED Lamp Reliability Test Standards" document ^{#1} for reliability test conditions.
3. Please refer to the "Cree LED Lamp Soldering & Handling" document ^{#2} for information about how to use this LED product safely.

#1: Refer to http://www.cree.com/led-components/media/documents/LED_Lamp_Reliability_Test_Standard.pdf

#2: Refer to <http://www.cree.com/led-components/media/documents/sh-HB.pdf>

GRAPHS

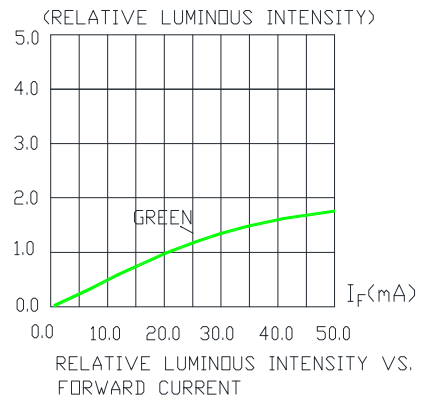
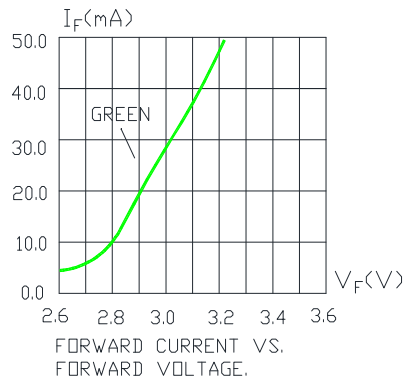
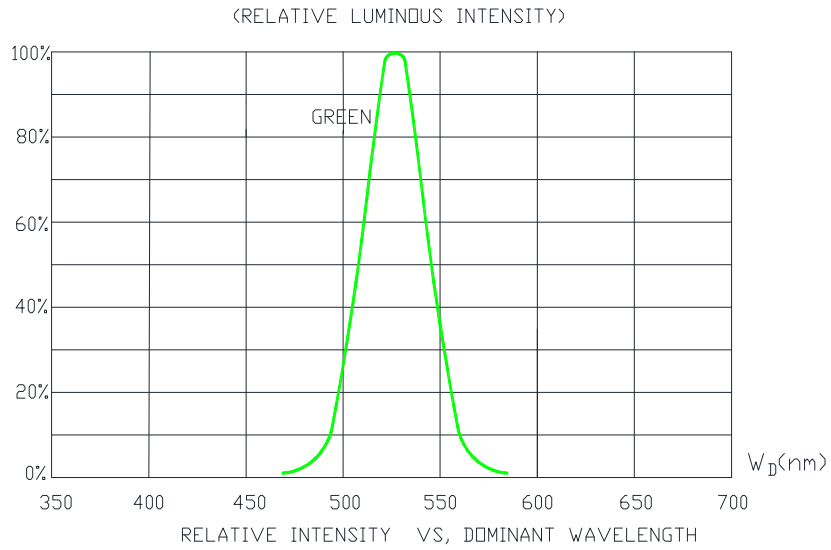

The above data are collected from statistical figures that do not necessarily correspond to the actual parameters of each single LED. Hence, these data will be changed without further notice.

GRAPHS

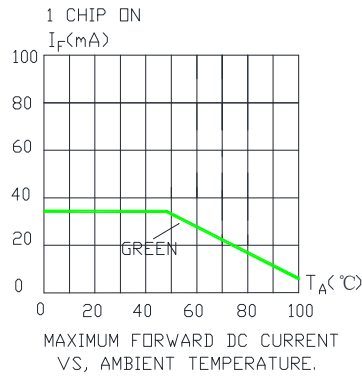
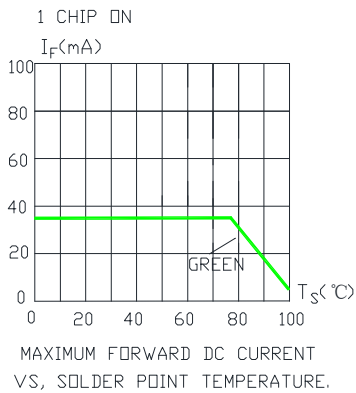
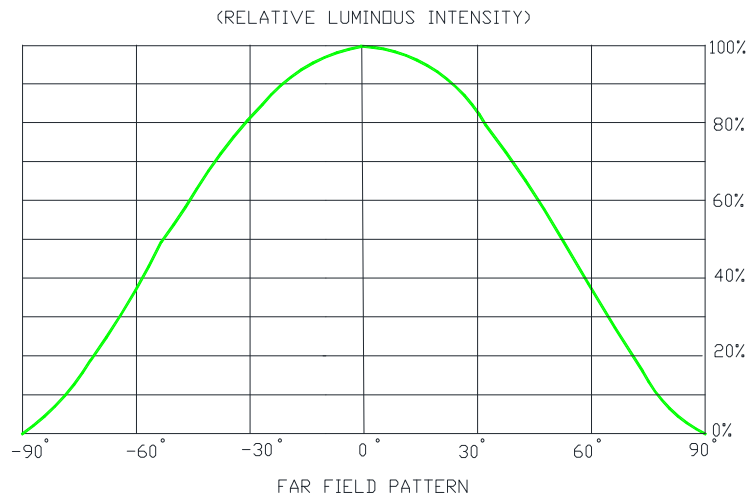

The above data are collected from statistical figures that do not necessarily correspond to the actual parameters of each single LED. Hence, these data will be changed without further notice.

MECHANICAL DIMENSIONS

All dimensions are in mm.

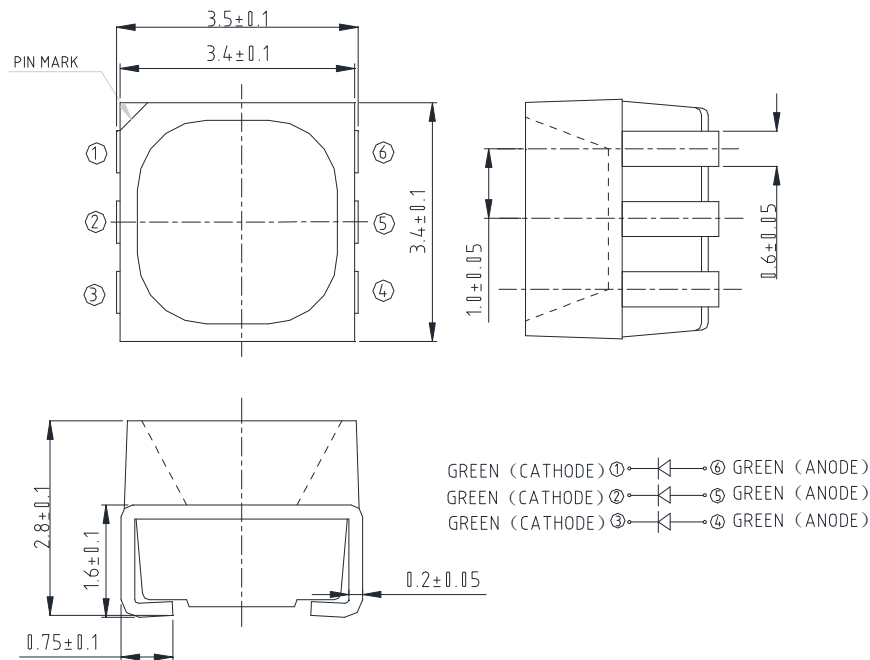

NOTES

RoHS Compliance

The levels of environmentally sensitive, persistent biologically toxic (PBT), persistent organic pollutants (POP), or otherwise restricted materials in this product are below the maximum concentration values (also referred to as the threshold limits) permitted for such substances, or are used in an exempted application, in accordance with EU Directive 2002/95/EC on the restriction of the use of certain hazardous substances in electrical and electronic equipment (RoHS), as amended through April 21, 2006.

Vision Advisory Claim

Users should be cautioned not to stare at the light of this LED product. The bright light can damage the eye.

KIT NUMBER SYSTEM

Cree LED lamps are tested and sorted into performance bins. A bin is specified by ranges of color, forward voltage, and brightness. Sorted LEDs are packaged for shipping in various convenient options. Please refer to the "Cree LED Lamp Packaging Standard" document for more information about shipping and packaging options.

Cree LEDs are sold by order codes in combinations of bins called kits. Order codes are configured in the following manner:

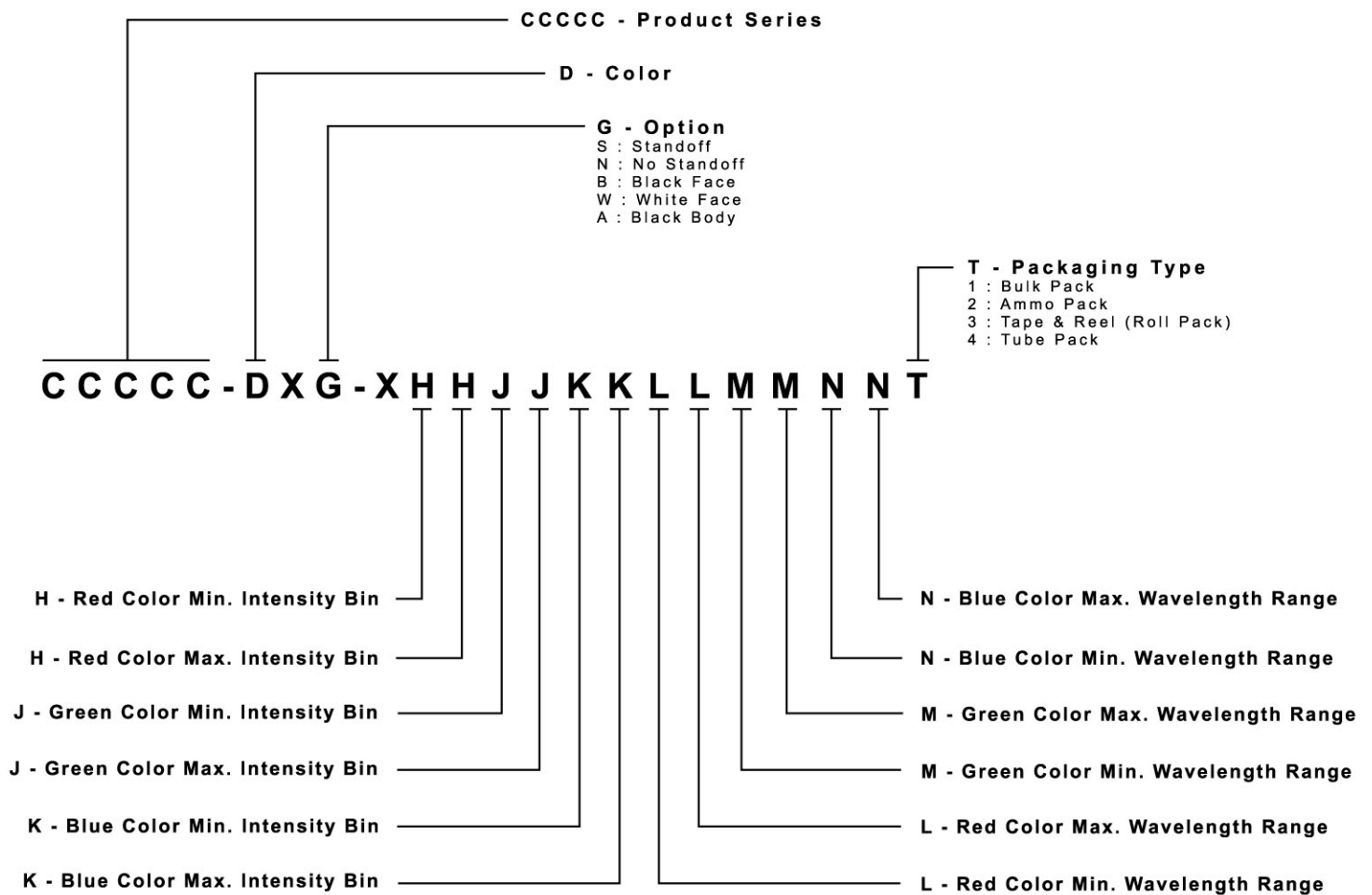

REFLOW SOLDERING

- The CLX6F-GKB is rated as a MSL 5a product.
- The recommended floor life out of bag is 24hrs.
- The temperature profile is as below.

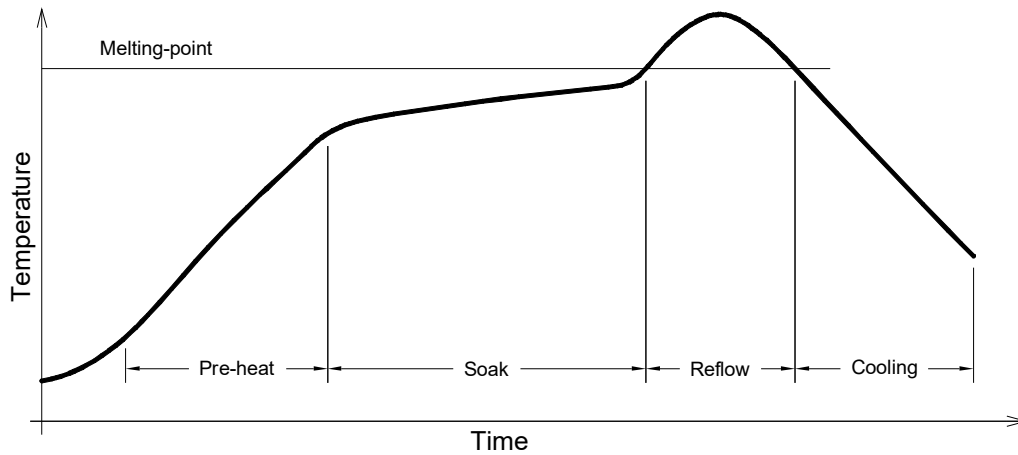

Use only with CLX6F-GKB

Solder
Average ramp-up rate = 4°C/s max
Preheat temperature = 150°C ~200°C
Preheat time = 120s max
Ramp-down rate = 6°C/s max
Peak temperature = 250°C max
Time within 5°C of actual Peak Temperature = 10s max
Duration above 217°C is 60s max

Refer to "<http://www.cree.com/led-components/media/documents/sh-HB.pdf>" for soldering & handling details.

NOTES

- The packaging sizes of these SMD products are very small and the resin is still soft after solidification. Users are required to handle with care. Never touch the resin surface of SMD products.
- To avoid damaging the product's surface and interior device, it is recommended to choose a special nozzle to pick up the SMD products during the process of SMT production. If handling is necessary, take special care when picking up these products. The following method is necessary:

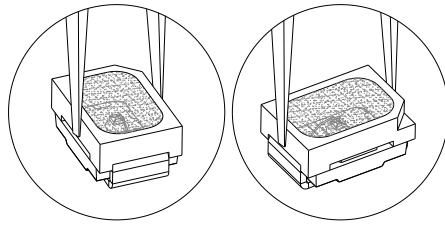

PACKAGING

- The boxes are not water resistant and they must be kept away from water and moisture.
- The LEDs are packed in cardboard boxes after packaging in normal or anti-electrostatic bags.
- Cardboard boxes will be used to protect the LEDs from mechanical shocks during transportation.
- The reel pack is applied in SMD LED.
- Max 2800 pcs per reel.

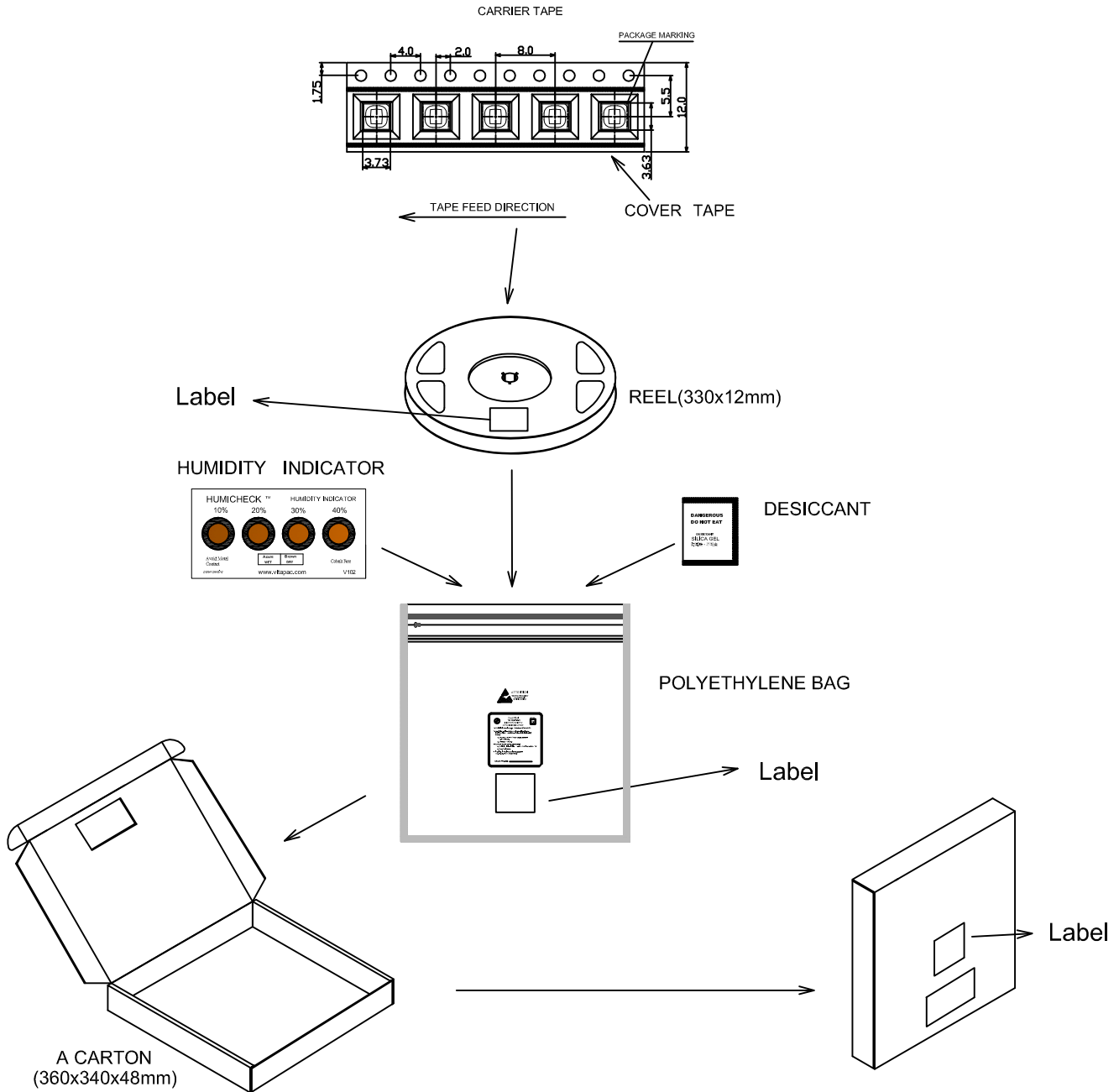



Компания «ЭлектроПласт» предлагает заключение долгосрочных отношений при поставках импортных электронных компонентов на взаимовыгодных условиях!

Наши преимущества:

- Оперативные поставки широкого спектра электронных компонентов отечественного и импортного производства напрямую от производителей и с крупнейших мировых складов;
- Поставка более 17-ти миллионов наименований электронных компонентов;
- Поставка сложных, дефицитных, либо снятых с производства позиций;
- Оперативные сроки поставки под заказ (от 5 рабочих дней);
- Экспресс доставка в любую точку России;
- Техническая поддержка проекта, помощь в подборе аналогов, поставка прототипов;
- Система менеджмента качества сертифицирована по Международному стандарту ISO 9001;
- Лицензия ФСБ на осуществление работ с использованием сведений, составляющих государственную тайну;
- Поставка специализированных компонентов (Xilinx, Altera, Analog Devices, Intersil, Interpoint, Microsemi, Aeroflex, Peregrine, Syfer, Eurofarad, Texas Instrument, Miteq, Cobham, E2V, MA-COM, Hittite, Mini-Circuits, General Dynamics и др.);

Помимо этого, одним из направлений компании «ЭлектроПласт» является направление «Источники питания». Мы предлагаем Вам помощь Конструкторского отдела:

- Подбор оптимального решения, техническое обоснование при выборе компонента;
- Подбор аналогов;
- Консультации по применению компонента;
- Поставка образцов и прототипов;
- Техническая поддержка проекта;
- Защита от снятия компонента с производства.



Как с нами связаться

Телефон: 8 (812) 309 58 32 (многоканальный)

Факс: 8 (812) 320-02-42

Электронная почта: org@eplast1.ru

Адрес: 198099, г. Санкт-Петербург, ул. Калинина, дом 2, корпус 4, литера А.