

Micro Chip Transformer DXP18BN□□□□□□

Reference Specification

1. Scope

This reference specification applies to Micro Chip Transformer DXP18BN Series.

2. Part Numbering

(ex.) $\frac{DX}{(1)} \frac{P}{(2)} \frac{18}{(3)} \frac{B}{(4)} \frac{N}{(5)} \frac{50}{(6)} \frac{14}{(7)} \frac{T}{(8)} \frac{L}{(9)}$

- | | |
|------------------------------------|--|
| (1) Micro Chip Transformer | (6) Port Impedance (50:50ohm / 75: 75ohm) |
| (2) Structure (P: Film Type) | (7) Impedance ratio (14: one to four) |
| (3) Dimension (L×W) | (8) Main Application (T :50~870MHz/H:470~790MHz/D:470~870MHz) |
| (4) Type of Transformer (B: Balun) | (9) Packing Code L:Taping / B:Bulk |
| (5) Category | |

3. Electrical Specification

Customer Part Number	Murata Part Number	Freq. Range [MHz]	input-output Impedance [ohm]	Insertion Loss [dB max.]	CMRR [dB min.]	Rated Power [dBm]
	DXP18BN5014TL	50-870	50-200	1.5	25	20
	DXP18BN5014TB					
	DXP18BN5014HL	470-790	50-200	1.2		
	DXP18BN5014HB					
	DXP18BN5016DL	470-870	50-300	1.2		
	DXP18BN5016DB					
	DXP18BN7514TL	50-870	75-300	1.5		
	DXP18BN7514TB					

Operating Temperature : -40 to +85°C Storage Temperature : -40 to +85°C

4. Standard Testing Condition

<Unless otherwise specified>
 Temperature : Ordinary Temperature 15 to 35°C
 Humidity : Ordinary Humidity 25 to 85%(RH)

<In case of doubt>
 Temperature : 20 ± 2°C
 Humidity : 60 to 70%(RH)
 Atmospheric Pressure : 86 to 106kPa

5. Style and Dimensions

■Dimension

(Top View)

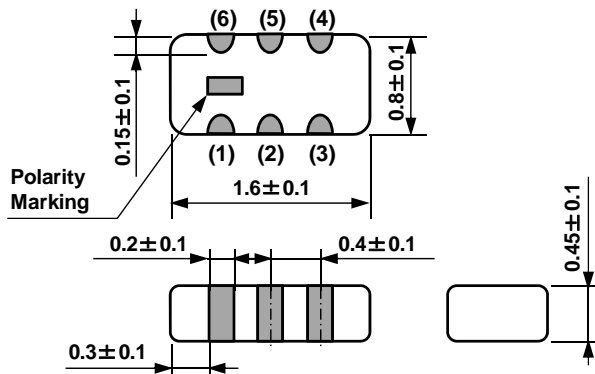

(Bottom View)

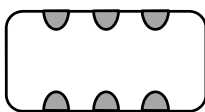

■ : Electrode (in mm)

■Equivalent Circuit

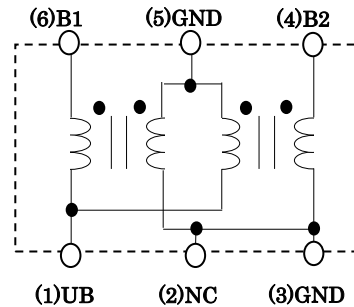

■Unit Mass (typ.)
0.003g

■ NC (Non-Contact) Terminal

Don't connect NC terminal with any signal lines/GND lines on the circuit board.

6. Marking

Polarity Marking is on the upper surface of a Product.

7. Electrical Performance

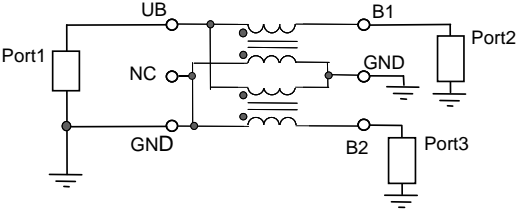
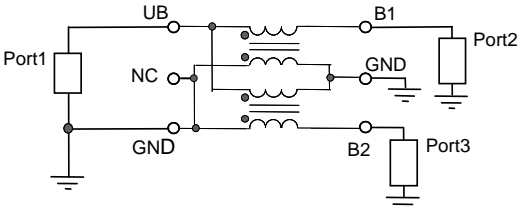
No.	Item	Specification	Definition and Measurement Method																				
7.1	Insertion Loss (IL)	Meet item 3.	<p>Insertion Loss is given by Sds21 mag extracted from the below circuit.</p> <p style="text-align: center;">Port Impedance [ohm]</p> <table border="1" style="margin-left: auto; margin-right: auto;"> <thead> <tr> <th></th> <th>Port1</th> <th>Port2</th> <th>Port3</th> </tr> </thead> <tbody> <tr> <td>5014H</td> <td>50</td> <td>100</td> <td>100</td> </tr> <tr> <td>5014T</td> <td>50</td> <td>100</td> <td>100</td> </tr> <tr> <td>5016D</td> <td>50</td> <td>150</td> <td>150</td> </tr> <tr> <td>7514T</td> <td>75</td> <td>150</td> <td>150</td> </tr> </tbody> </table> <p>IL[dB] = 20log₁₀(Sds21) Where Sds21 is S-parameter of single mode stimulus - Differential mode response</p> <p>Parasitics and loss factors caused by the test board have to be removed.</p> 		Port1	Port2	Port3	5014H	50	100	100	5014T	50	100	100	5016D	50	150	150	7514T	75	150	150
	Port1	Port2	Port3																				
5014H	50	100	100																				
5014T	50	100	100																				
5016D	50	150	150																				
7514T	75	150	150																				
7.2	CMRR	Meet item 3.	<p>CMRR is given by the following equation, S-parameters are extracted from the below circuit.</p> <p style="text-align: center;">Port Impedance [ohm]</p> <table border="1" style="margin-left: auto; margin-right: auto;"> <thead> <tr> <th></th> <th>Port1</th> <th>Port2</th> <th>Port3</th> </tr> </thead> <tbody> <tr> <td>5014H</td> <td>50</td> <td>100</td> <td>100</td> </tr> <tr> <td>5014T</td> <td>50</td> <td>100</td> <td>100</td> </tr> <tr> <td>5016D</td> <td>50</td> <td>150</td> <td>150</td> </tr> <tr> <td>7514T</td> <td>75</td> <td>150</td> <td>150</td> </tr> </tbody> </table> <p>CMRR[dB] = 20log₁₀(Sds21/Scs21)=20log₁₀{(S21+S31)/(S21-S31)} Where Sds21 is S-parameter of single mode stimulus - Differential mode response Scs21 is S-parameter of single mode stimulus - Common mode response</p> <p>Parasitics and loss factors caused by the test board have to be removed.</p> 		Port1	Port2	Port3	5014H	50	100	100	5014T	50	100	100	5016D	50	150	150	7514T	75	150	150
	Port1	Port2	Port3																				
5014H	50	100	100																				
5014T	50	100	100																				
5016D	50	150	150																				
7514T	75	150	150																				

Reference Only

SpecNo.JEFK243A-0002H-01

P3/10

8. Mechanical Performance

No.	Item	Specification	Test Method					
8.1	Appearance and Dimensions	Meet all dimension on item 5.	Visual Inspection and measurement with microscope.					
8.2	Solderability	The electrodes shall be at least 95% covered with new solder coating.	Flux: Ethanol solution of rosin, 25(wt)% Pre-Heating : 150±10°C 60s to 90s Solder : Sn-3.0Ag-0.5Cu Solder Temperature : 240±5°C Immersion Time : 3±1 seconds Immersion and emersion rates : 25mm/s					
8.3	Resistance to Soldering Heat	Meet Table 1. <table border="1" style="width: 100%; border-collapse: collapse;"> <tr> <td style="width: 50%;">Appearance</td> <td>No damaged</td> </tr> <tr> <td>IL</td> <td rowspan="2">Meet Item 3.</td> </tr> <tr> <td>CMRR</td> </tr> </table>	Appearance	No damaged	IL	Meet Item 3.	CMRR	Flux : Ethanol solution of rosin, 25(wt)% Pre-Heating : : 150±10°C 60s to 90s Solder : Sn-3.0Ag-0.5Cu Solder Temperature : 270±5°C Immersion Time : 10±1 seconds Immersion and emersion rates : 25mm/s Then measured after exposure in the room condition for 4 to 48 hours.
Appearance	No damaged							
IL	Meet Item 3.							
CMRR								
8.4	Drop		It shall be dropped on concrete or steel board. Method : free fall Height : 1 m The Number of Times : 3 times					
8.5	Vibration		It shall be soldered on the substrate. Oscillation Frequency : 10 to 2000 to 10Hz for 15 minutes Total Amplitude 3.0mm or Acceleration 196m/s ² whichever is smaller Testing Time : A period of 2 hours in each of 3 mutually perpendicular directions. (Total 6 hours)					
8.6	Bending Strength		It shall be soldered on the Glass-epoxy substrate. Deflection : 3mm (t=1.0mm). Keeping time : 5 seconds Speed of Applying Force : 0.5mm/s <div style="text-align: center;"> </div>					

9. Environmental Performance(Products shall be soldered on the substrate.)

No.	Item	Specification	Test Method
9.1	Temperature Cycle	Meet Table 1.	1 Cycle Step 1 -40°C(+0°C,-3°C) / 30(+3,-0) min Step 2 Ordinary Temp. / within 3 min Step 3 +85(+3°C,-0°C) / 30(+3,-0) min Step 4 Ordinary Temp. / within 3 min Total of 100 cycles. Then measured after exposure in the room condition for 4 to 48 hours.
9.2	Humidity		Temperature : 70±2°C Humidity : 90~95%(RH) Time : 1000(+48 hours,-0 hours) Then measured after exposure in the room condition for 4 to 48 hours.
9.3	Heat Resistance		Temperature : 85±2°C Time : 1000(+48 hours,-0 hours) Then measured after exposure in the room condition for 4 to 48 hours.
9.4	Cold Resistance		Temperature : -40± 2°C Time : 1000(+48 hours,-0 hours) Then measured after exposure in the room condition for 4 to 48 hours.

10. Frequency Characteristics (Typ.)

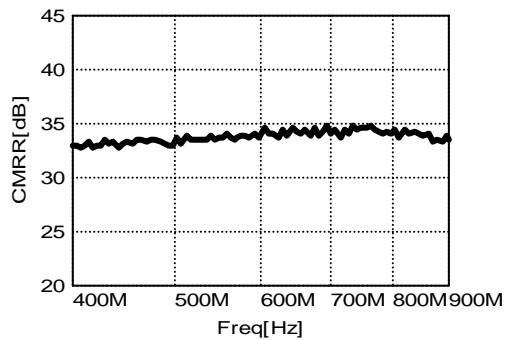
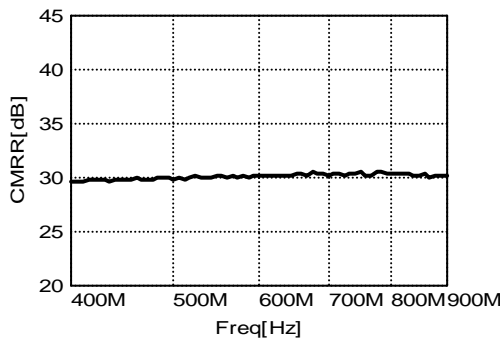
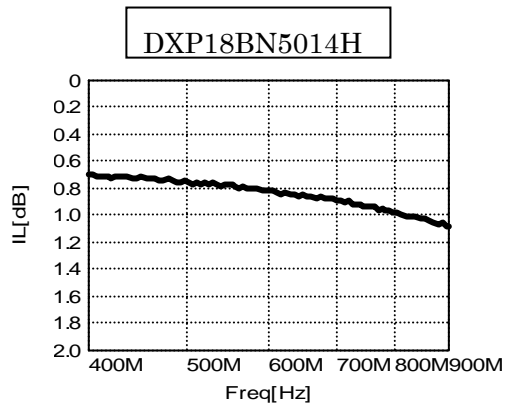
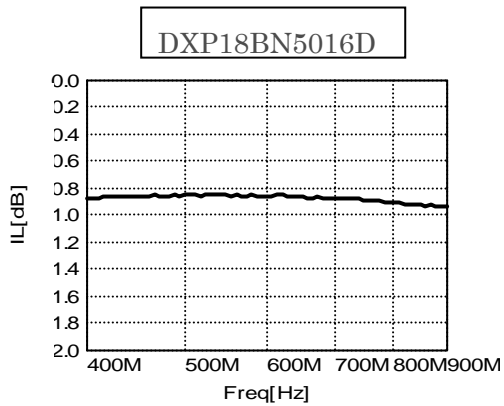
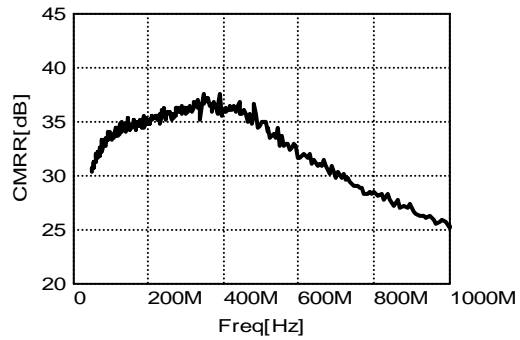
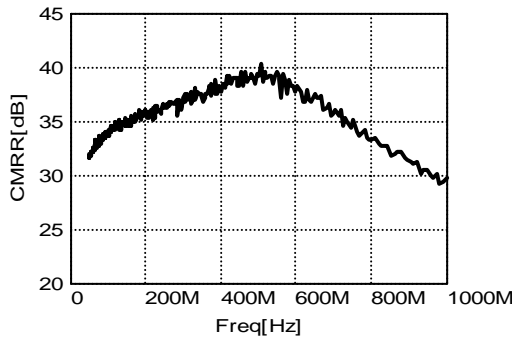
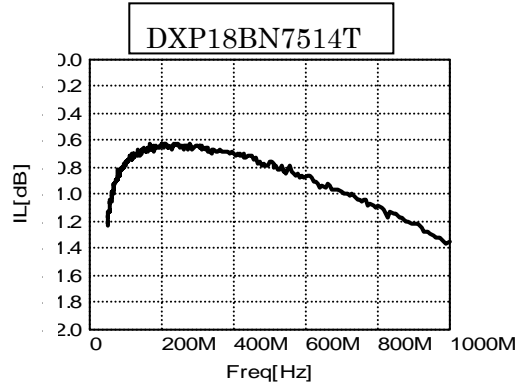
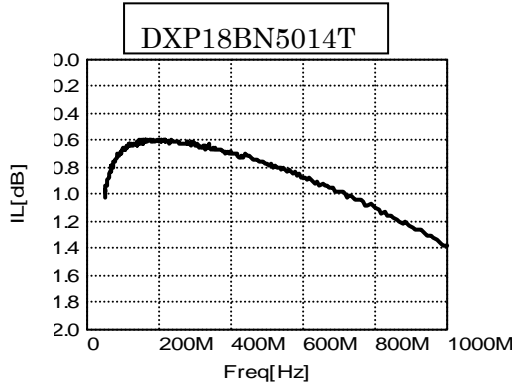

11. Specification of Packaging

11.1 Appearance and Dimensions (8mm-wide,Plastic tape)

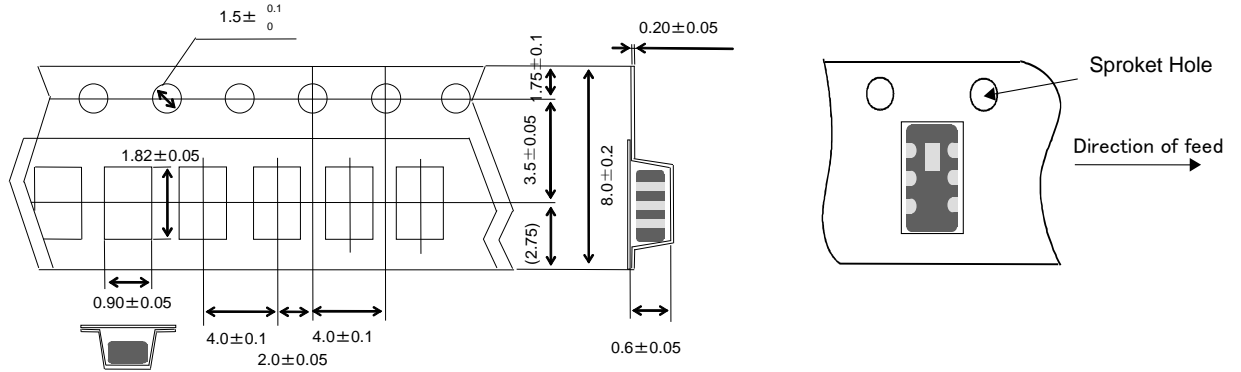

11.2 Specification of Taping

- (1)Packing quantity(Standard quantity) 5000 pcs. / reel
- (2)Packing Method
Products shall be packaged in each embossed cavity of plastic tape and sealed with cover tape.
- (3) Spliced point
The cover tape have no spliced point.
- (4) Sprocket Hole
Sprocket hole shall be located on the left hand side toward the direction of feed.
- (5)Missing components number
Missing components number within 0.1% of the number per reel or 1 pc, whichever is greater, and are not continuous. The specified quantity per reel is kept.

11.3 Pull Strength of the Tape Package

Plastic Tape	5N min.
Cover Tape	10N min.

11.4 Peeling force of the Cover Tape

0.2 to 0.7N(Minimum value is Typical)
Peeling verosity is 300 mm / min

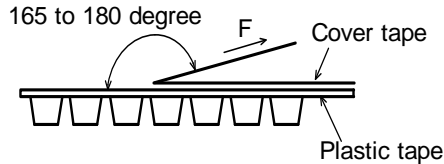

11.5 Dimensions of Leader-tape, Trailer and Reel

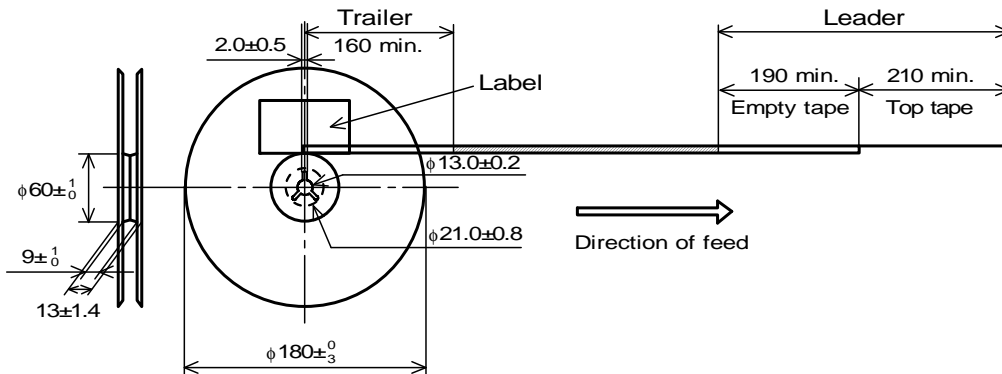

11.6 Marking for reel

Customer part number, MURATA part number, Inspection number(*1), RoHS Marking(*2), Quantity, etc

*1) « Expression of Inspection No. » □□ 0000 XXX
(1) (2) (3)

(1) Factory Code
 (2) Date First digit : Year / Last digit of year
 Second digit : Month / Jan. to Sep. → 1 to 9, Oct. to Dec. → O,N,D
 Third, Fourth digit : Day

(3) Serial No.

*2) « Expression of RoHS Marking » ROHS – Y (Δ)
(1) (2)

(1) RoHS regulation conformity parts.
 (2) MURATA classification number

11.7 Marking for Outside package

Customer name Purchasing Order Number, Customer Part Number, MURATA part number, RoHS Marking (*2), Quantity, etc

11.8 Specification of Outer Case

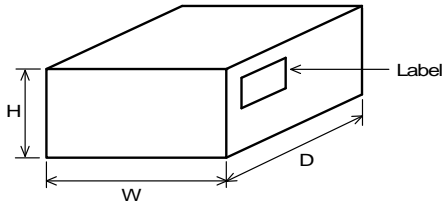

Outer Case Dimensions (mm)			Standard Reel Quantity in Outer Case (Reel)
W	D	H	
186	186	93	5

* Above Outer Case size is typical. It depends on a quantity of an order.

12. ⚠ Caution

12.1. Mounting Direction

Mount products in right direction.

Wrong direction which is 180 ° rotated from right direction cause serious trouble.

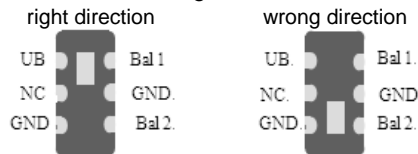

12.2. Limitation of Applications

Please contact us before using our products for the applications listed below which require especially high reliability for the prevention of defects which might directly cause damage to the third party's life, body or property.

- (1) Aircraft equipment
 - (2) Aerospace equipment
 - (3) Undersea equipment
 - (4) Power plant control equipment
 - (5) Medical equipment
- (6) Transportation equipment (vehicles, trains, ships, etc.)
 - (7) Traffic signal equipment
 - (8) Disaster prevention / crime prevention equipment
 - (9) Data-processing equipment
 - (10) Applications of similar complexity and / or reliability requirements to the applications listed in the above.

13. Notice

Products can only be soldered with reflow.

This product is designed for solder mounting.

Please consult us in advance for applying other mounting method such as conductive adhesive.

13.1 NC (Non-Contact) Terminal

Don't connect NC terminal with any signal lines/GND lines on the circuit board, unless otherwise, it may affect on the performance of this part.

Solder the NC terminal on soldering pad, which has no electrical connection with any other lines, to secure the fixing strength of the part and to prevent displacement of the part during reflow soldering.

13.2 Flux and Solder

Flux	Use rosin-based flux, (with converting chlorine content 0.06 to 0.1(wt)% .), but not highly acidic flux (with Halogen content exceeding 0.2(wt)% conversion to chlorine). Do not use water-soluble flux.
Solder	Use Sn-3.0Ag-0.5Cu solder Standard thickness of the solder paste should be 100 to 150µm.

13.3 Standard Land Dimensions (Reflow)

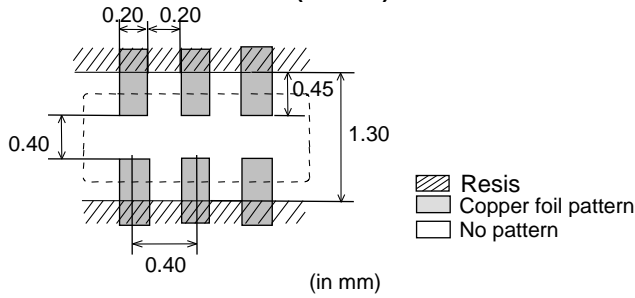

13.4 Assembling

<Thermal Shock>

Pre-heating should be in such a way that the temperature difference between solder and ceramic surface is limited to 100°C MAX. Also cooling into solvent after soldering should be in such a way that the temperature difference is limited to 100°C max.

13.5 Standard Soldering Condition

(1) Soldering Condition

Standard soldering profile and the limit soldering profile is as follows.

The excessive limit soldering conditions may cause leaching of the electrode and / or resulting in the deterioration of product quality.

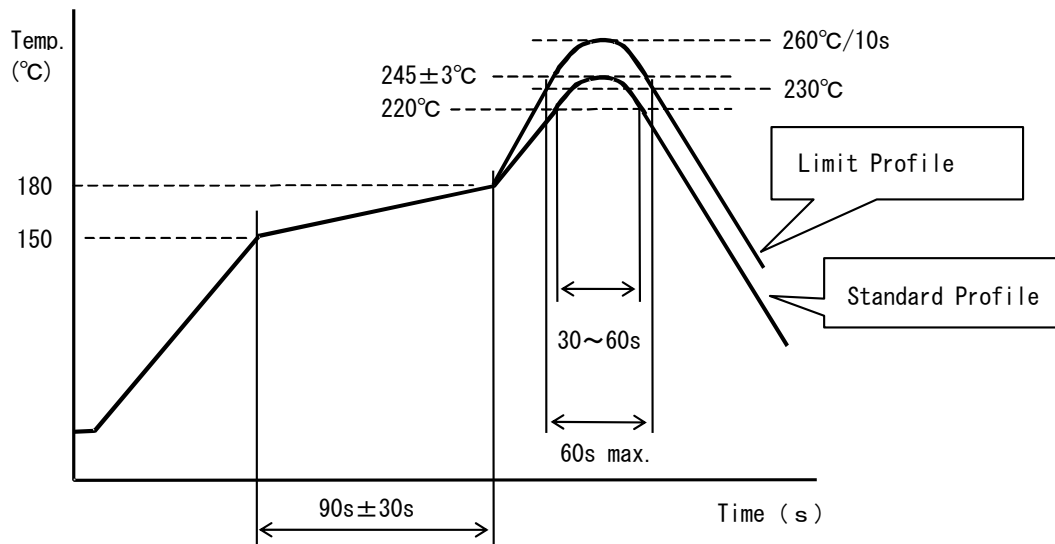

	Standard Profile	Limit Profile
Pre-heating	150~180°C、90s±30s	
Heating	above 220°C、30s~60s	above 230°C、60s max.
Peak temperature	245±3°C	260°C、10s
Cycle of reflow	2 times	2 times

(2) Reworking with Soldering iron

The following conditions must be strictly followed when using a soldering iron after being mounted by reflow soldering.

Tip temperature / Soldering time : 350°C max / 3(+1,-0)s

Soldering iron output :30W max

Tip diameter : φ3mm

*Reworking should be limited to 2 times.

Notes: Do not touch the products directly with the soldering iron.

(3) Solder Volume

Solder shall be used not to be exceeded the upper limits as shown below.

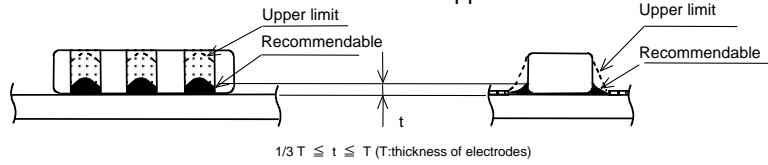

Accordingly increasing the solder volume, the mechanical stress to Chip is also increased. Exceeding solder volume may cause the failure of mechanical or electrical performance.

13.6 Resin coating

The electric characteristics may change and/or it may affect on the product's performance due to high cure-stress of resin to be used for coating / molding products. So please pay your careful attention when you select resin. In prior to use, please make the reliability evaluation with the product mounted in your application set.

13.7 Attention regarding P.C.B. bending

The following shall be considered when designing and laying out P.C.B.'s.

(1) P.C.B. shall be designed so that products are not subject to the mechanical stress due to warping the board.

[Products direction]

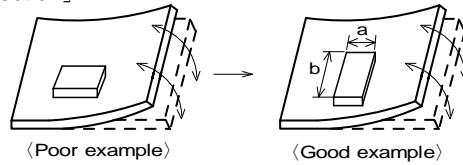

Products shall be location the sideways Direction (Length : a<b) to the machanical Stress.

[Warping direction]

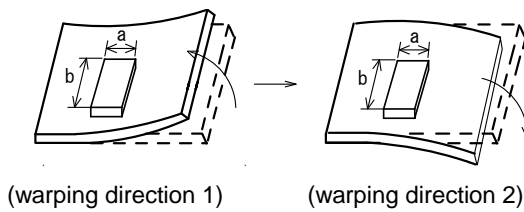

Products(warping direction 1, warping direction 2) shall be located carefully so that products are not subjected to the mechanical stress due to warping the board. Because they may be subjected the mechanical stress in order of warping direction 1>warping direction 2.

(2) Components location on P.C.B. separation.

It is effective to implement the following measures, to reduce stress in separating the board. It is best to implement all of the following three measures; however, implement as many measures as possible to reduce stress.

Contents of Measures	Stress Level
(1) Turn the mounting direction of the component parallel to the board separation surface.	A > D *1
(2) Add slits in the board separation part.	A > B
(3) Keep the mounting position of the component away from the board separation surface.	A > C

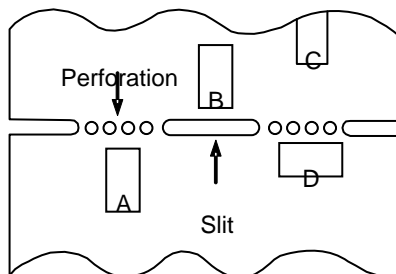

*1 A > D is valid when stress is added vertically to the perforation as with Hand Separation. If a Cutting Disc is used, stress will be diagonal to the PCB, therefore A > D is invalid.

(3) Mounting Components Near Screw Holes

When a component is mounted near a screw hole, it may be affected by the board deflection that occurs During the tightening of the screw. Mount the component in a position as far away from the screw holes as possible.

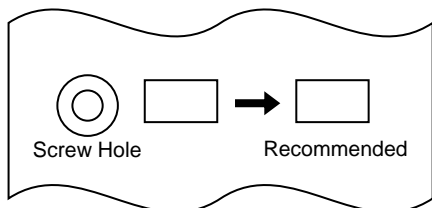

13.8 Attention Regarding P.C.B. Design

< The Arrangement of Products >

P.C.B. shall be designed so that products are far from the portion of perforation.

The portion of perforation shall be designed as narrow as possible and shall be designed so as not to be applied the stress in the case of P.C.B. separation.

Products shall not be arranged on the line of a series of holes when there are big holes in P.C.B. (Because the stress concentrate on the line of holes.)

< Products Placing >

Support pins shall be set under P.C.B. to prevent causing a warp to P.C.B. during placing the products on the other side of P.C.B.

< P.C.B. Separation >

P.C.B. shall not be separated with hand.

P.C.B. shall be separated with the fixture so as not to cause P.C.B. bending.

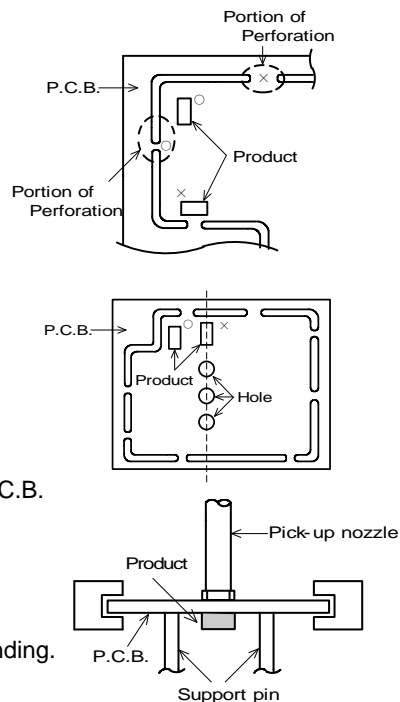

13.9 Cleaning Conditions

Products shall be cleaned on the following conditions.

- (1) Cleaning temperature shall be limited to 60°C max. (40°C max. for Isopropyl alcohol.)
- (2) Ultrasonic cleaning shall comply with the following conditions, avoiding the resonance phenomenon at the mounted products and P.C.B..
 - Power : 20W/ l max. • Frequency : 28kHz to 40kHz • Time : 5 minutes max.
- (3) Cleaner
 1. Alternative cleaner • Isopropyl alcohol (IPA)
 2. Aqueous agent • PINE ALPHA ST-100S
- (4) There shall be no residual flux and residual cleaner after cleaning.

In the case of using aqueous agent, products shall be dried completely after rinse with de-ionized water in order to remove the cleaner.
- (5) Other cleaning

Please contact us.

13.10 Handling of a substrate

After mounting products on a substrate, do not apply any stress to the product caused by bending or twisting to the substrate when cropping the substrate, inserting and removing a connector from the substrate or tightening screw to the substrate.

Excessive mechanical stress may cause cracking in the product.

Bending

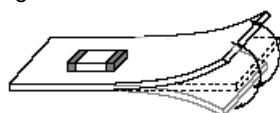

Twisting

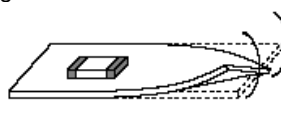

13.11 Operating Environment

Do not use this product under the following environmental conditions, on deterioration of the performance, such as insulation resistance may result from the use.

- (1) in corrosive gases (acidic gases, alkaline gases, chlorine, sulfur gases, organic gases and etc.)
- (2) in the atmosphere where liquid such as organic solvent, may splash on the products.

13.12 Storage Condition**(1) Storage period**

Use the products within 12 months after delivered.

Solderability should be checked if this period is exceeded.

(2) Storage environment conditions

·Products should be stored in the warehouse on the following conditions.

Temperature : -10 ~ +40°C

Humidity : 15 to 85% relative humidity No rapid change on temperature and humidity.

- Products should not be stored in corrosive gases, such as sulfurous, acid gases, alkaline gases, to prevent the following deterioration. Poor solderability due to the oxidized electrode.
- Products should be stored on the palette for the prevention of the influence from humidity,dust and so on.
- Products should be stored in the warehouse without heat shock, vibration, direct sunlight and so on.
- Products should not be stored under the air tights packaged condition.

(3) Delivery

Care should be taken when transporting or handling product to avoid excessive vibration or mechanical shock.

14.  Notes

- (1)Please make sure that your product has been evaluated in view of your specifications with our product being mounted to your product.
- (2)You are requested not to use our product deviating from the reference specifications.
- (3)The contents of this reference specification are subject to change without advance notice. Please approve our product specifications or transact the approval sheet for product specifications before ordering.



Компания «ЭлектроПласт» предлагает заключение долгосрочных отношений при поставках импортных электронных компонентов на взаимовыгодных условиях!

Наши преимущества:

- Оперативные поставки широкого спектра электронных компонентов отечественного и импортного производства напрямую от производителей и с крупнейших мировых складов;
- Поставка более 17-ти миллионов наименований электронных компонентов;
- Поставка сложных, дефицитных, либо снятых с производства позиций;
- Оперативные сроки поставки под заказ (от 5 рабочих дней);
- Экспресс доставка в любую точку России;
- Техническая поддержка проекта, помощь в подборе аналогов, поставка прототипов;
- Система менеджмента качества сертифицирована по Международному стандарту ISO 9001;
- Лицензия ФСБ на осуществление работ с использованием сведений, составляющих государственную тайну;
- Поставка специализированных компонентов (Xilinx, Altera, Analog Devices, Intersil, Interpoint, Microsemi, Aeroflex, Peregrine, Syfer, Eurofarad, Texas Instrument, Miteq, Cobham, E2V, MA-COM, Hittite, Mini-Circuits, General Dynamics и др.);

Помимо этого, одним из направлений компании «ЭлектроПласт» является направление «Источники питания». Мы предлагаем Вам помощь Конструкторского отдела:

- Подбор оптимального решения, техническое обоснование при выборе компонента;
- Подбор аналогов;
- Консультации по применению компонента;
- Поставка образцов и прототипов;
- Техническая поддержка проекта;
- Защита от снятия компонента с производства.



Как с нами связаться

Телефон: 8 (812) 309 58 32 (многоканальный)

Факс: 8 (812) 320-02-42

Электронная почта: org@eplast1.ru

Адрес: 198099, г. Санкт-Петербург, ул. Калинина, дом 2, корпус 4, литера А.