

# MC33269, NCV33269

## 800 mA, Adjustable Output, Low Dropout Voltage Regulator

The MC33269/NCV33269 series are low dropout, medium current, fixed and adjustable, positive voltage regulators specifically designed for use in low input voltage applications. These devices offer the circuit designer an economical solution for precision voltage regulation, while keeping power losses to a minimum.

The regulator consists of a 1.0 V dropout composite PNP-NPN pass transistor, current limiting, and thermal shutdown.

### Features

- 3.3 V, 5.0 V, 12 V and Adjustable Versions  
2.85 V version available as MC34268
- Space Saving DPAK, SO-8 and SOT-223 Power Packages
- 1.0 V Dropout
- Output Current in Excess of 800 mA
- Thermal Protection
- Short Circuit Protection
- Output Trimmed to 1.0% Tolerance
- Pb-Free Packages are Available
- NCV Prefix for Automotive and Other Applications Requiring Site and Control Changes

### DEVICE TYPE/NOMINAL OUTPUT VOLTAGE

MC33269D	Adj	MC33269D-5.0	5.0 V
NCV33269D*	Adj	MC33269DT-5.0	5.0 V
MC33269DT	Adj	NCV33269DT-5.0*	5.0 V
NCV33269DTRK*	Adj	NCV33269DTRK-5.0*	5.0 V
MC33269T	3.3 V	MC33269T-5.0	5.0 V
MC33269D-3.3	3.3 V	MC33269D-012	12 V
MC33269DT-3.3	3.3 V	MC33269DT-012	12 V
NCV33269DTRK-3.3*	3.3 V	NCV33269DTRK-012*	12 V
MC33269T-3.3	3.3 V	MC33269T-012	12 V
MC33269ST-3.3			

\*NCV prefix is for automotive and other applications requiring site and change control.



ON Semiconductor®

<http://onsemi.com>

 SO-8  
D SUFFIX  
CASE 751

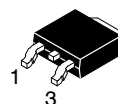
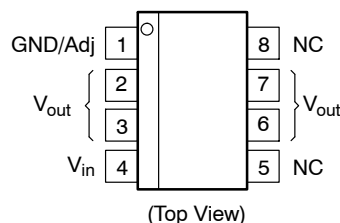

DPAK  
DT SUFFIX  
CASE 369C

1. GND/Adj
2.  $V_{out}$
3.  $V_{in}$

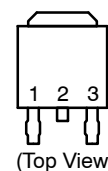

SOT-223  
ST SUFFIX  
CASE 318E

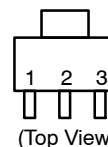

Heatsink surface (shown as terminal 4 in case outline drawing) is connected to Pin 2.

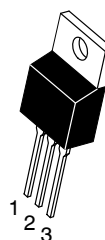

TO-220AB  
T SUFFIX  
CASE 221AB

1. GND/Adj
2.  $V_{out}$
3.  $V_{in}$

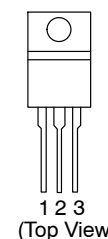

Heatsink surface (shown as terminal 4 in case outline drawing) is connected to Pin 2.

### ORDERING INFORMATION

See detailed ordering and shipping information in the package dimensions section on page 7 of this data sheet.

### DEVICE MARKING INFORMATION

See general marking information in the device marking section on page 9 of this data sheet.

# MC33269, NCV33269

## MAXIMUM RATINGS

Rating	Symbol	Value	Unit
Power Supply Input Voltage	$V_{in}$	20	V
Power Dissipation			
Case 369C (DPAK) $T_A = 25^\circ\text{C}$	$P_D$	Internally Limited	W
Thermal Resistance, Junction-to-Ambient	$\theta_{JA}$	92	$^\circ\text{C/W}$
Thermal Resistance, Junction-to-Case	$\theta_{JC}$	6.0	$^\circ\text{C/W}$
Case 751 (SO-8) $T_A = 25^\circ\text{C}$	$P_D$	Internally Limited	W
Thermal Resistance, Junction-to-Ambient	$\theta_{JA}$	160	$^\circ\text{C/W}$
Thermal Resistance, Junction-to-Case	$\theta_{JC}$	25	$^\circ\text{C/W}$
Case 221A (TO-220) $T_A = 25^\circ\text{C}$	$P_D$	Internally Limited	W
Thermal Resistance, Junction-to-Ambient	$\theta_{JA}$	65	$^\circ\text{C/W}$
Thermal Resistance, Junction-to-Case	$\theta_{JC}$	5.0	$^\circ\text{C/W}$
Case 318E (SOT-223) $T_A = 25^\circ\text{C}$	$P_D$	Internally Limited	W
Thermal Resistance, Junction-to-Ambient	$\theta_{JA}$	156	$^\circ\text{C/W}$
Thermal Resistance, Junction-to-Case	$\theta_{JC}$	15	$^\circ\text{C/W}$
Operating Die Junction Temperature Range	$T_J$	-40 to +150	$^\circ\text{C}$
Operating Ambient Temperature Range MC33269 NCV33269	$T_A$	-40 to +125 -40 to +125	$^\circ\text{C}$
Storage Temperature	$T_{stg}$	-55 to +150	$^\circ\text{C}$
Electrostatic Discharge Sensitivity (ESD) Human Body Model (HBM) Machine Model (MM)	ESD	4000 400	V

Stresses exceeding Maximum Ratings may damage the device. Maximum Ratings are stress ratings only. Functional operation above the Recommended Operating Conditions is not implied. Extended exposure to stresses above the Recommended Operating Conditions may affect device reliability.

## ELECTRICAL CHARACTERISTICS ( $C_O = 10 \mu\text{F}$ , $T_A = 25^\circ\text{C}$ , for min/max values $T_A = -40^\circ\text{C}$ to $+125^\circ\text{C}$ , unless otherwise noted.)

Characteristic	Symbol	Min	Typ	Max	Unit
Output Voltage ( $I_{out} = 10 \text{ mA}$ , $T_A = 25^\circ\text{C}$ ) 3.3 Suffix ( $V_{CC} = 5.3 \text{ V}$ ) 5.0 Suffix ( $V_{CC} = 7.0 \text{ V}$ ) 12 Suffix ( $V_{CC} = 14 \text{ V}$ )	$V_O$	3.27 4.95 11.88	3.3 5.0 12	3.33 5.05 12.12	V
Output Voltage (Line, Load and Temperature) (Note 1) ( $1.25 \text{ V} \leq V_{in} - V_{out} \leq 15 \text{ V}$ , $I_{out} = 500 \text{ mA}$ ) ( $1.35 \text{ V} \leq V_{in} - V_{out} \leq 10 \text{ V}$ , $I_{out} = 800 \text{ mA}$ ) 3.3 Suffix 5.0 Suffix 12 Suffix	$V_O$	3.23 4.9 11.76	3.3 5.0 12	3.37 5.1 12.24	V
Reference Voltage for Adjustable Voltage ( $I_{out} = 10 \text{ mA}$ , $V_{in} - V_{out} = 2.0 \text{ V}$ , $T_A = 25^\circ\text{C}$ )	$V_{ref}$	1.235	1.25	1.265	V
Reference Voltage (Line, Load and Temperature) (Note 1) for Adjustable Voltage ( $1.25 \text{ V} \leq V_{in} - V_{out} \leq 15 \text{ V}$ , $I_{out} = 500 \text{ mA}$ ) ( $1.35 \text{ V} \leq V_{in} - V_{out} \leq 10 \text{ V}$ , $I_{out} = 800 \text{ mA}$ )	$V_{ref}$	1.225	1.25	1.275	V
Line Regulation ( $I_{out} = 10 \text{ mA}$ , $V_{in} = [V_{out} + 1.5 \text{ V}]$ to $V_{in} = 20 \text{ V}$ , $T_A = 25^\circ\text{C}$ )	$Reg_{line}$	-	-	0.3	%
Load Regulation ( $V_{in} = V_{out} + 3.0 \text{ V}$ , $I_{out} = 10 \text{ mA}$ to $800 \text{ mA}$ , $T_A = 25^\circ\text{C}$ )	$Reg_{load}$	-	-	0.5	%
Dropout Voltage ( $I_{out} = 500 \text{ mA}$ ) ( $I_{out} = 800 \text{ mA}$ )	$V_{in} - V_{out}$	-	1.0 1.1	1.25 1.35	V
Ripple Rejection (10 $V_{pp}$ , 120 Hz Sinewave; $I_{out} = 500 \text{ mA}$ )	RR	55	-	-	dB
Current Limit ( $V_{in} - V_{out} = 10 \text{ V}$ )	$I_{Limit}$	800	-	-	mA
Quiescent Current (Fixed Output) ( $1.5 \text{ V} \leq V_{out} \leq 3.3 \text{ V}$ ) ( $5 \text{ V} \leq V_{out} \leq 12 \text{ V}$ )	$I_Q$	-	5.5 -	8.0 20	mA
Minimum Required Load Current Fixed Output Voltage Adjustable Voltage	$I_{Load}$	- 8.0	- -	0 -	mA
Adjustment Pin Current	$I_{Adj}$	-	-	120	$\mu\text{A}$

1. The MC33269-12,  $V_{in} - V_{out}$  is limited to 8.0 V maximum, because of the 20 V maximum rating applied to  $V_{in}$ .

# MC33269, NCV33269

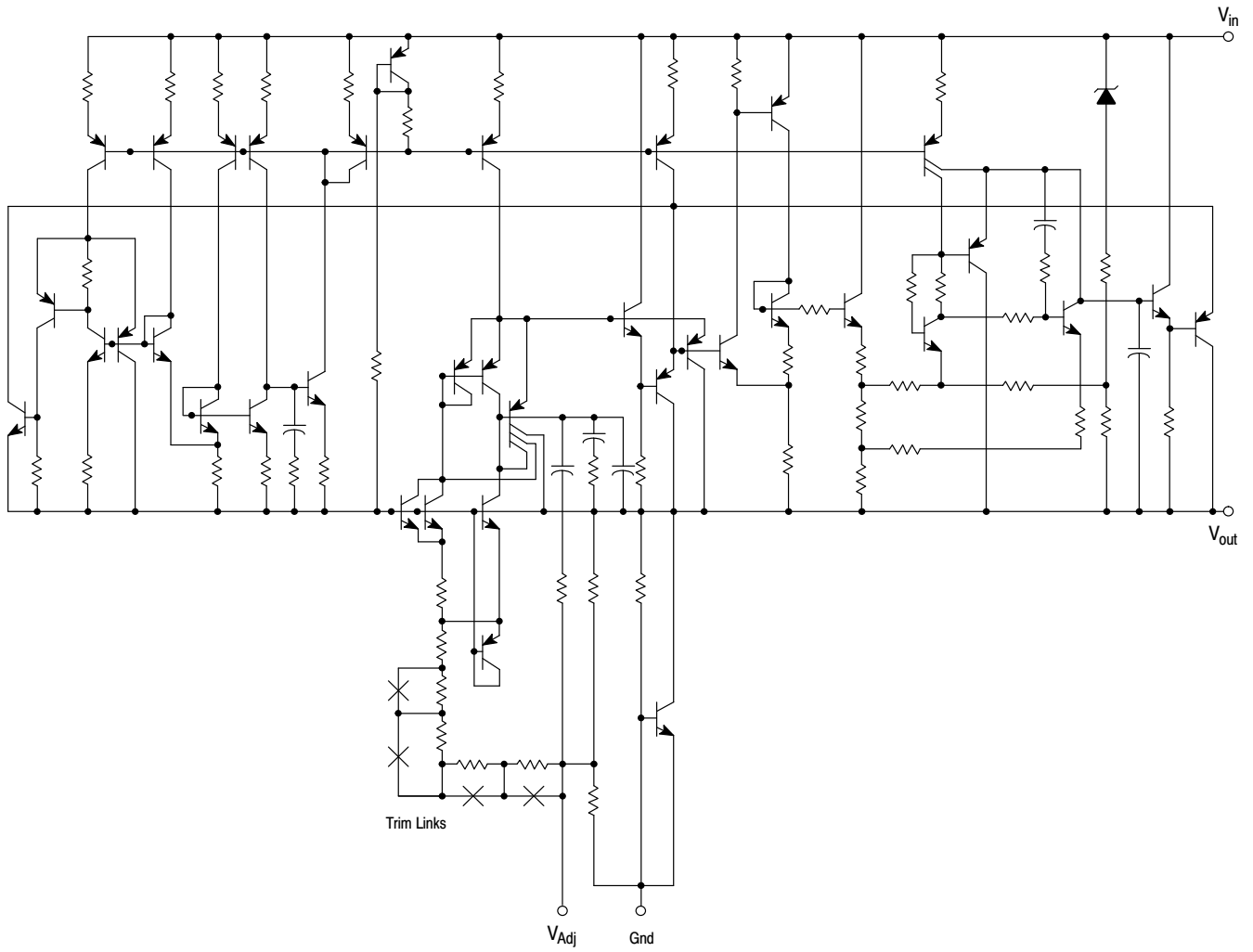

This device contains 38 active transistors.

**Figure 1. Internal Schematic**

# MC33269, NCV33269

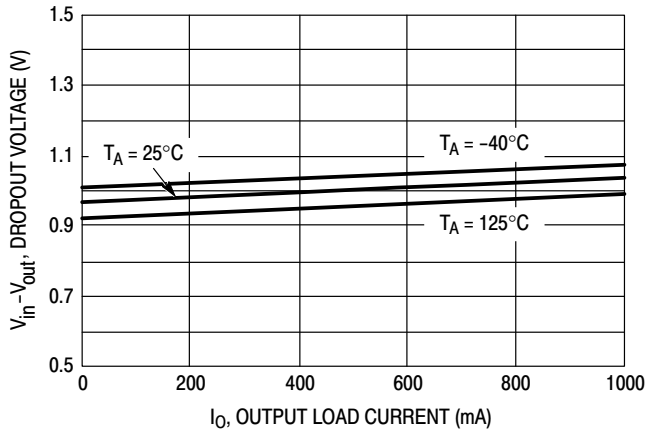

**Figure 2. Dropout Voltage versus Output Load Current**

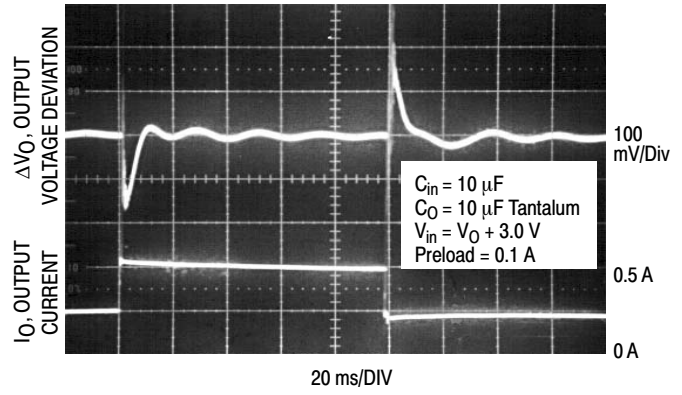

**Figure 3. Transient Load Regulation**

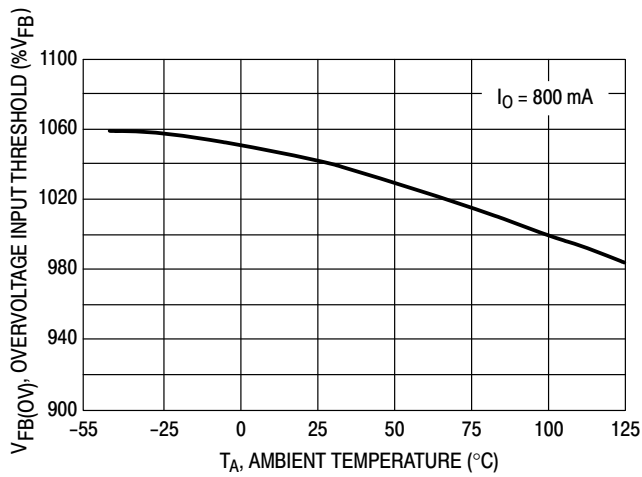

**Figure 4. Dropout Voltage versus Temperature**

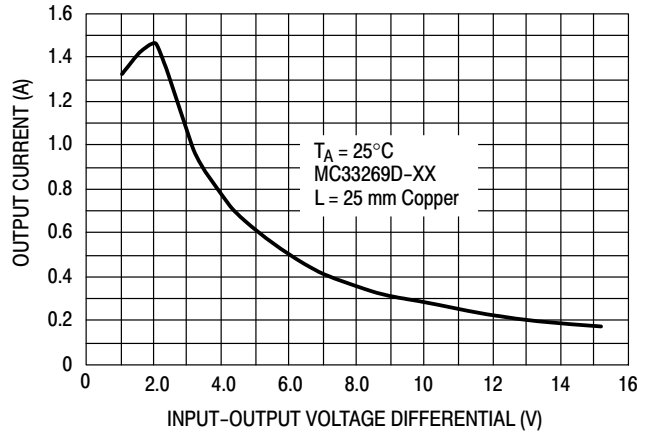

**Figure 5. MC33269-XX Output DC Current versus Input-Output Differential Voltage**

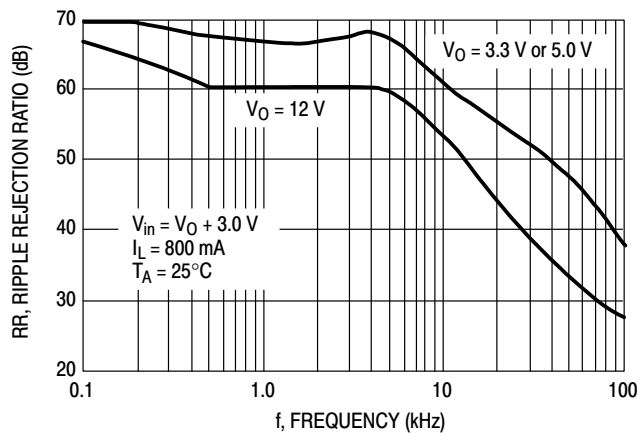

**Figure 6. MC33269 Ripple Rejection versus Frequency**

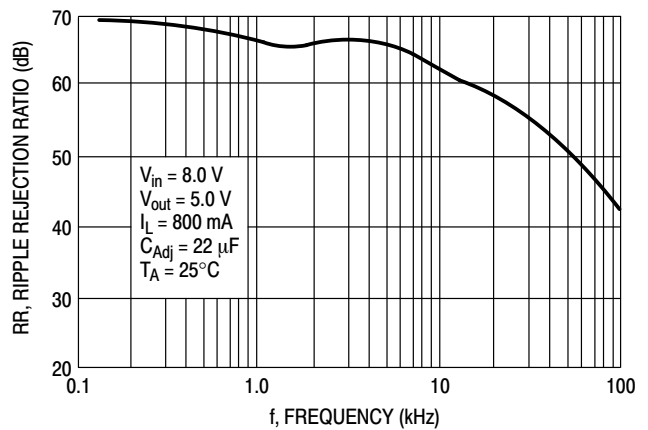

**Figure 7. MC33269-ADJ Ripple Rejection versus Frequency**

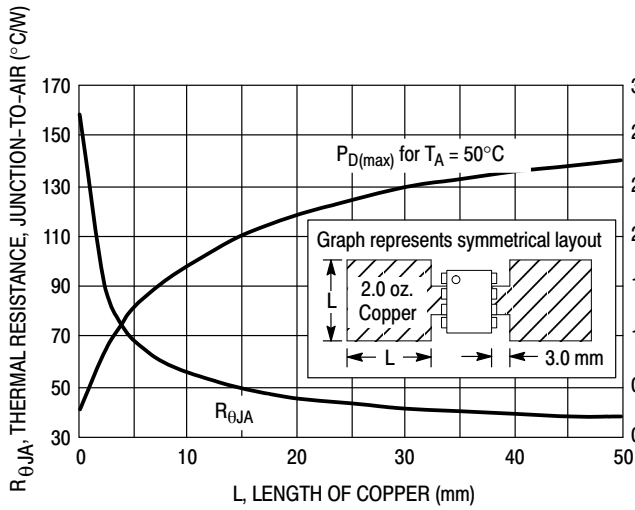

Figure 8. SOP-8 Thermal Resistance and Maximum Power Dissipation versus P.C.B. Copper Length

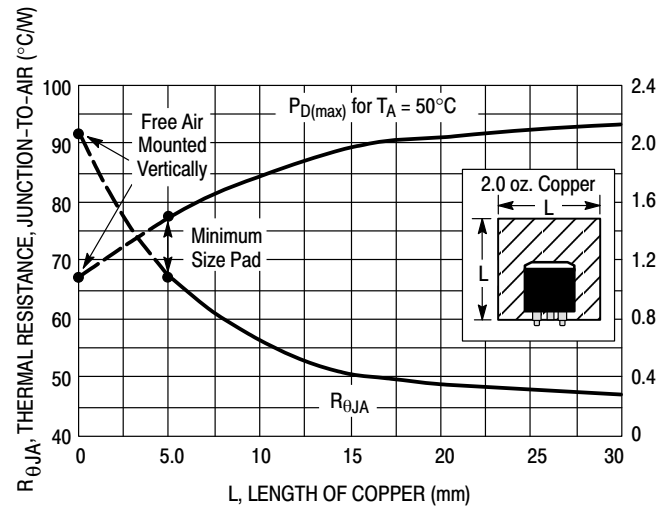

Figure 9. DPAK Thermal Resistance and Maximum Power Dissipation versus P.C.B. Copper Length

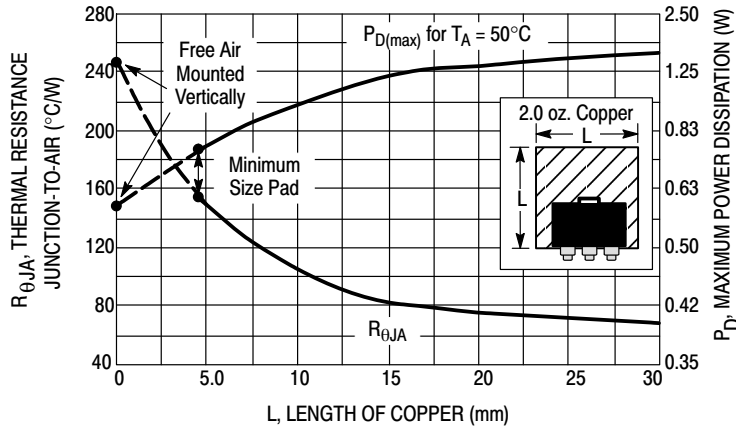

Figure 10. SOT-223 Thermal Resistance and Maximum Power Dissipation versus P.C.B. Copper Length

APPLICATIONS INFORMATION

Figures 11 through 15 are typical application circuits. The output current capability of the regulator is in excess of 800 mA, with a typical dropout voltage of less than 1.0 V. Internal protective features include current and thermal limiting.

\* The MC33269 requires an external output capacitor for stability. The capacitor should be at least 10 μF with an equivalent series resistance (ESR) of less than 10 Ω but greater than 0.2 Ω over the anticipated operating temperature range. With economical electrolytic capacitors, cold temperature operation can pose a problem. As temperature decreases, the capacitance also decreases and the ESR increases, which could cause the circuit to oscillate. Also capacitance and ESR of a solid tantalum capacitor is more stable over temperature. The use of a low ESR ceramic capacitor placed within close proximity to the output of the device could cause instability.

\*\* An input bypass capacitor is recommended to improve transient response or if the regulator is connected to the

supply input filter with long wire lengths. This will reduce the circuit's sensitivity to the input line impedance at high frequencies. A 0.33 μF or larger tantalum, mylar, ceramic, or other capacitor having low internal impedance at high frequencies should be chosen. The bypass capacitor should be mounted with shortest possible lead or track length directly across the regulator's input terminals. **Applications should be tested over all operating conditions to insure stability.**

Internal thermal limiting circuitry is provided to protect the integrated circuit in the event that the maximum junction temperature is exceeded. When activated, typically at 170°C, the output is disabled. There is no hysteresis built into the thermal limiting circuit. As a result, if the device is overheating, the output will appear to be oscillating. This feature is provided to prevent catastrophic failures from accidental device overheating. **It is not intended to be used as a substitute for proper heat-sinking.**

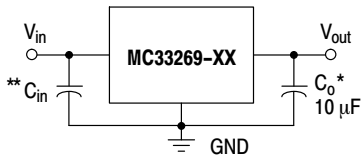

An input capacitor is not necessary for stability, however it will improve the overall performance.

Figure 11. Typical Fixed Output Application

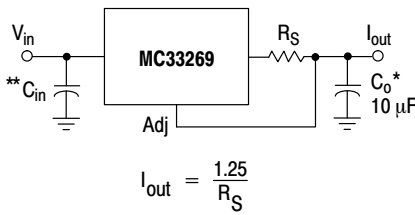

$$I_{out} = \frac{1.25}{R_S}$$

Figure 13. Current Regulator

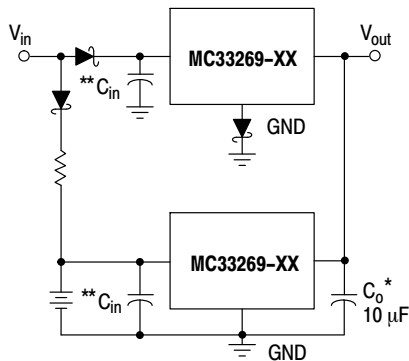

The Schottky diode in series with the ground leg of the upper regulator shifts its output voltage higher by the forward voltage drop of the diode. This will cause the lower device to remain off until the input voltage is removed.

Figure 14. Battery Backed-Up Power Supply

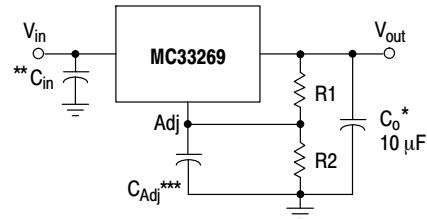

$$V_{out} = 1.25 \left( 1 + \frac{R2}{R1} \right) + I_{Adj} R2$$

\*\*\*C<sub>Adj</sub> is optional, however it will improve the ripple rejection. The MC34269 develops a 1.25 V reference voltage between the output and the adjust terminal. Resistor R1, operates with constant current to flow through it and resistor R2. This current should be set such that the Adjust Pin current causes negligible drop across resistor R2. The total current with minimum load should be greater than 8.0 mA.

Figure 12. Typical Adjustable Output Application

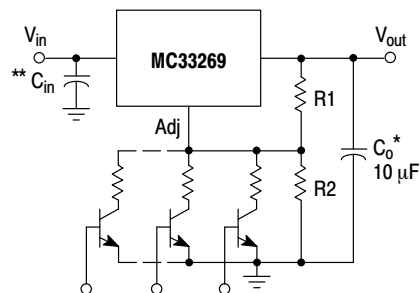

R<sub>2</sub> sets the maximum output voltage. Each transistor reduces the output voltage when turned on.

Figure 15. Digitally Controlled Voltage Regulator

## MC33269, NCV33269

### ORDERING INFORMATION

Device	Package	Shipping Information†
MC33269D	SO-8	98 Units / Rail
MC33269DG	SO-8 (Pb-Free)	
MC33269DR2	SO-8	2500 Units / Tape & Reel
MC33269DR2G	SO-8 (Pb-Free)	
MC33269DT	DPAK	75 Units / Rail
MC33269DTG	DPAK (Pb-Free)	
MC33269DTRK	DPAK	2500 Units / Tape & Reel
MC33269DTRKG	DPAK (Pb-Free)	
MC33269T	TO-220	50 Units / Rail
MC33269TG	TO-220 (Pb-Free)	
MC33269D-3.3	SO-8	98 Units / Rail
MC33269D-3.3G	SO-8 (Pb-Free)	
MC33269DR2-3.3	SO-8	2500 Units / Tape & Reel
MC33269DR2-3.3G	SO-8 (Pb-Free)	
MC33269DT-3.3	DPAK	75 Units / Rail
MC33269DT-3.3G	DPAK (Pb-Free)	
MC33269DTRK-3.3	DPAK	2500 Units / Tape & Reel
MC33269DTRK-3.3G	DPAK (Pb-Free)	
MC33269ST-3.3T3	SOT-223	4000 Units / Tape & Reel
MC33269ST-3.3T3G	SOT-223 (Pb-Free)	
MC33269T-3.3	TO-220	50 Units / Rail
MC33269T-3.3G	TO-220 (Pb-Free)	
MC33269D-5.0	SO-8	98 Units / Rail
MC33269D-5.0G	SO-8 (Pb-Free)	
MC33269DR2-5.0	SO-8	2500 Units / Tape & Reel
MC33269DR2-5.0G	SO-8 (Pb-Free)	
MC33269DT-5.0	DPAK	75 Units / Rail
MC33269DT-5.0G	DPAK (Pb-Free)	
NCV33269DT-5.0G*	DPAK (Pb-Free)	
MC33269DTRK-5.0	DPAK	2500 Units / Tape & Reel
MC33269DTRK-5.0G	DPAK (Pb-Free)	

†For information on tape and reel specifications, including part orientation and tape sizes, please refer to our Tape and Reel Packaging Specifications Brochure, BRD8011/D.

\*NCV prefix is for automotive and other applications requiring site and control changes.

## MC33269, NCV33269

### ORDERING INFORMATION (continued)

Device	Package	Shipping Information†
MC33269T-5.0	TO-220	50 Units / Rail
MC33269T-5.0G	TO-220 (Pb-Free)	
MC33269D-012	SO-8	98 Units / Rail
MC33269D-012G	SO-8 (Pb-Free)	
MC33269DR2-012	SO-8	2500 Units / Tape & Reel
MC33269DR2-012G	SO-8 (Pb-Free)	
MC33269DT-012	DPAK	75 Units / Rail
MC33269DT-012G	DPAK (Pb-Free)	
MC33269DTRK-012	DPAK	2500 Units / Tape & Reel
MC33269DTRK-012G	DPAK (Pb-Free)	
MC33269T-012	TO-220	50 Units / Rail
MC33269T-012G	TO-220 (Pb-Free)	
NCV33269DR2G*	SO-8 (Pb-Free)	2500 Units / Tape & Reel
NCV33269DTRK*	DPAK	
NCV33269DTRKG*	DPAK (Pb-Free)	
NCV33269DTRK-3.3*	DPAK	
NCV33269DTRK3.3G*	DPAK (Pb-Free)	
NCV33269DTRK-5.0*	DPAK	
NCV33269DTRK5.0G*	DPAK (Pb-Free)	
NCV33269DTRK-012*	DPAK	
NCV33269DTRK-12G*	DPAK (Pb-Free)	

†For information on tape and reel specifications, including part orientation and tape sizes, please refer to our Tape and Reel Packaging Specifications Brochure, BRD8011/D.

\*NCV prefix is for automotive and other applications requiring site and control changes.



# MC33269, NCV33269

## MARKING DIAGRAMS

### SO-8 D SUFFIX CASE 751

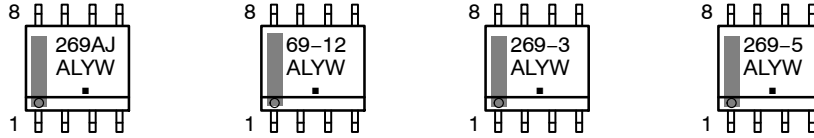

### DPAK DT SUFFIX CASE 369C

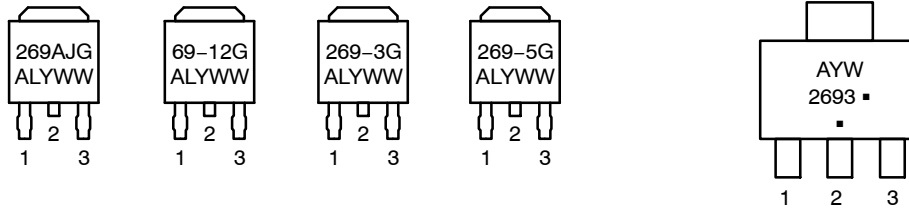

### TO-220AB T SUFFIX CASE 221A

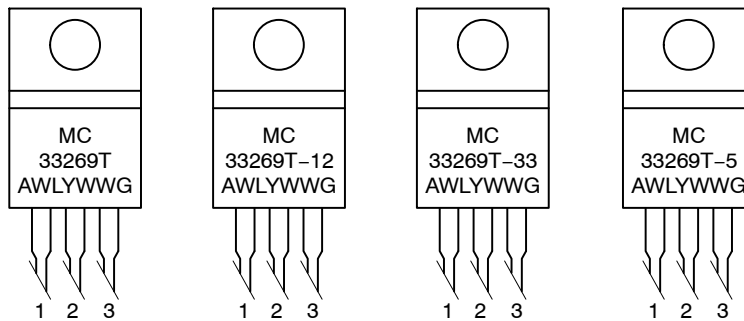

A = Assembly Location  
 L, WL = Wafer Lot  
 Y = Year  
 W, WW = Work Week  
 G = Pb-Free Package  
 ■ = Pb-Free Package  
 (Note: Microdot may be in either location)

# MC33269, NCV33269

## PACKAGE DIMENSIONS

SO-8  
D SUFFIX  
CASE 751-07  
ISSUE AJ

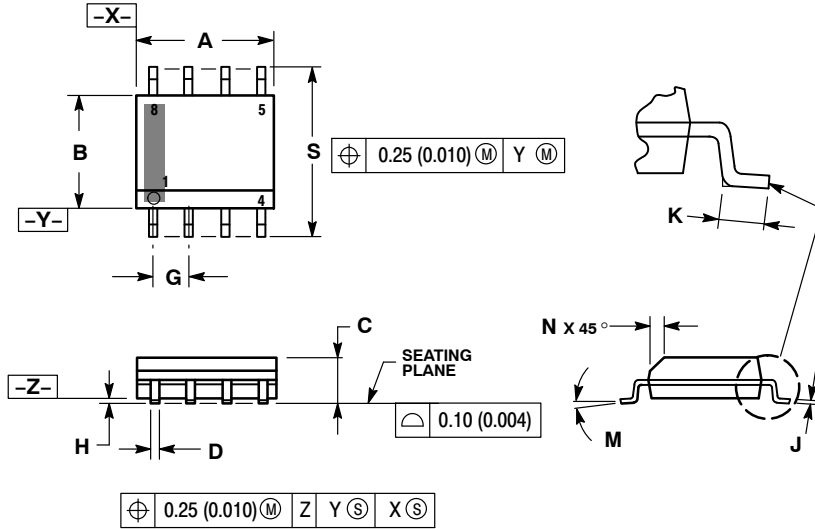

### NOTES:

1. DIMENSIONING AND TOLERANCING PER ANSI Y14.5M, 1982.
2. CONTROLLING DIMENSION: MILLIMETER.
3. DIMENSION A AND B DO NOT INCLUDE MOLD PROTRUSION.
4. MAXIMUM MOLD PROTRUSION 0.15 (0.006) PER SIDE.
5. DIMENSION D DOES NOT INCLUDE DAMBAR PROTRUSION. ALLOWABLE DAMBAR PROTRUSION SHALL BE 0.127 (0.005) TOTAL IN EXCESS OF THE D DIMENSION AT MAXIMUM MATERIAL CONDITION.
6. 751-01 THRU 751-06 ARE OBSOLETE. NEW STANDARD IS 751-07.

DIM	MILLIMETERS		INCHES	
	MIN	MAX	MIN	MAX
A	4.80	5.00	0.189	0.197
B	3.80	4.00	0.150	0.157
C	1.35	1.75	0.053	0.069
D	0.33	0.51	0.013	0.020
G	1.27 BSC		0.050 BSC	
H	0.10	0.25	0.004	0.010
J	0.19	0.25	0.007	0.010
K	0.40	1.27	0.016	0.050
M	0° 8°		0° 8°	
N	0.25	0.50	0.010	0.020
S	5.80	6.20	0.228	0.244

### SOLDERING FOOTPRINT\*

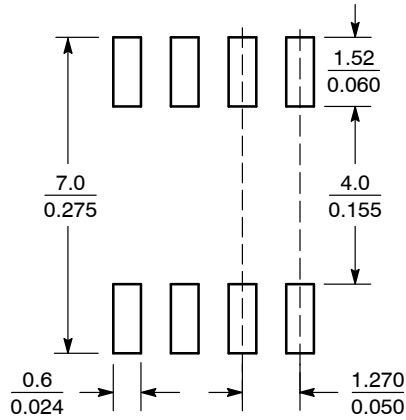

SCALE 6:1  $\left(\frac{\text{mm}}{\text{inches}}\right)$

\*For additional information on our Pb-Free strategy and soldering details, please download the ON Semiconductor Soldering and Mounting Techniques Reference Manual, SOLDERRM/D.

# MC33269, NCV33269

## PACKAGE DIMENSIONS

DPAK  
DT SUFFIX  
CASE 369C-01  
ISSUE D

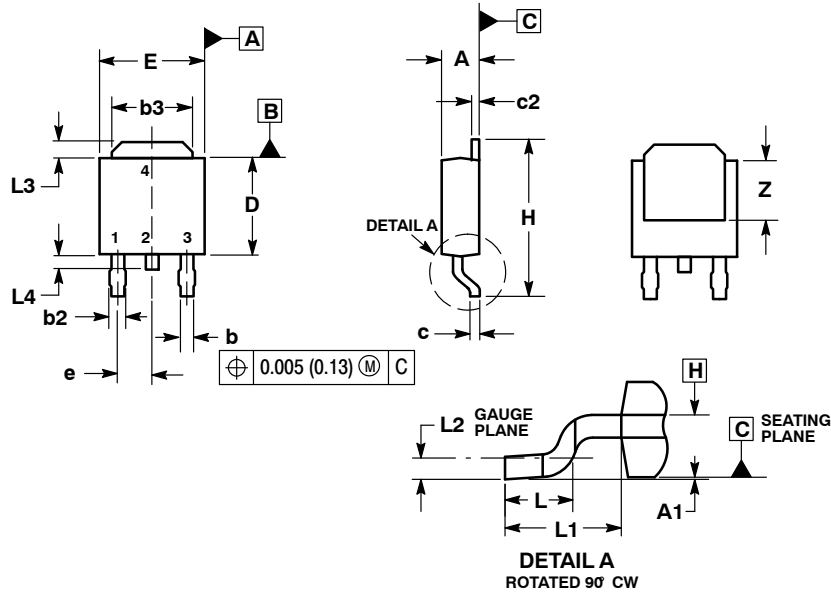

**NOTES:**

1. DIMENSIONING AND TOLERANCING PER ASME Y14.5M, 1994.
2. CONTROLLING DIMENSION: INCHES.
3. THERMAL PAD CONTOUR OPTIONAL WITHIN DIMENSIONS b3, L3 and Z.
4. DIMENSIONS D AND E DO NOT INCLUDE MOLD FLASH, PROTRUSIONS, OR BURRS. MOLD FLASH, PROTRUSIONS, OR GATE BURRS SHALL NOT EXCEED 0.006 INCHES PER SIDE.
5. DIMENSIONS D AND E ARE DETERMINED AT THE OUTERMOST EXTREMES OF THE PLASTIC BODY.
6. DATUMS A AND B ARE DETERMINED AT DATUM PLANE H.

DIM	INCHES		MILLIMETERS	
	MIN	MAX	MIN	MAX
A	0.086	0.094	2.18	2.38
A1	0.000	0.005	0.00	0.13
b	0.025	0.035	0.63	0.89
b2	0.030	0.045	0.76	1.14
b3	0.180	0.215	4.57	5.46
c	0.018	0.024	0.46	0.61
c2	0.018	0.024	0.46	0.61
D	0.235	0.245	5.97	6.22
E	0.250	0.265	6.35	6.73
e	0.090 BSC		2.29 BSC	
H	0.370	0.410	9.40	10.41
L	0.055	0.070	1.40	1.78
L1	0.108 REF		2.74 REF	
L2	0.020 BSC		0.51 BSC	
L3	0.035	0.050	0.89	1.27
L4	---	0.040	---	1.01
Z	0.155	---	3.93	---

### SOLDERING FOOTPRINT\*

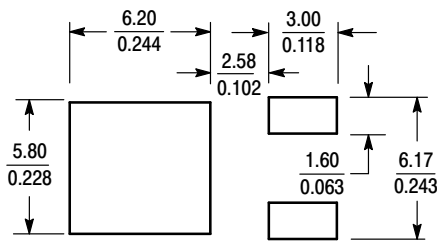

SCALE 3:1  $\left(\frac{\text{mm}}{\text{inches}}\right)$

\*For additional information on our Pb-Free strategy and soldering details, please download the ON Semiconductor Soldering and Mounting Techniques Reference Manual, SOLDERRM/D.

# MC33269, NCV33269

## PACKAGE DIMENSIONS

SOT-223  
ST SUFFIX  
CASE 318E-04  
ISSUE M

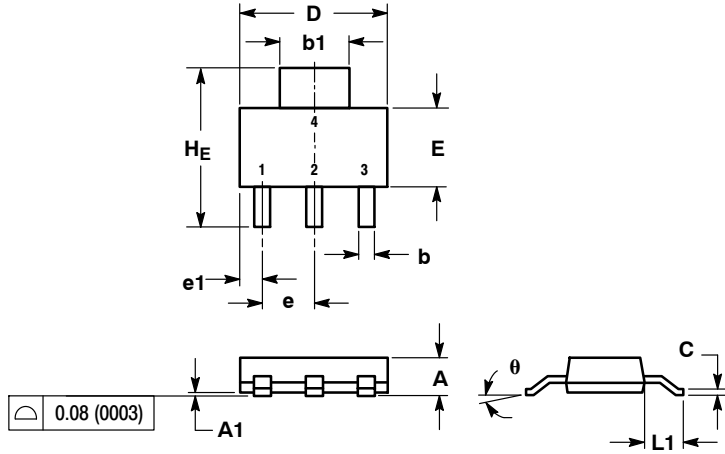

- NOTES:  
1. DIMENSIONING AND TOLERANCING PER ANSI Y14.5M, 1982.  
2. CONTROLLING DIMENSION: INCH.

DIM	MILLIMETERS			INCHES		
	MIN	NOM	MAX	MIN	NOM	MAX
A	1.50	1.63	1.75	0.060	0.064	0.068
A1	0.02	0.06	0.10	0.001	0.002	0.004
b	0.60	0.75	0.89	0.024	0.030	0.035
b1	2.90	3.06	3.20	0.115	0.121	0.126
c	0.24	0.29	0.35	0.009	0.012	0.014
D	6.30	6.50	6.70	0.249	0.256	0.263
E	3.30	3.50	3.70	0.130	0.138	0.145
e	2.20	2.30	2.40	0.087	0.091	0.094
e1	0.85	0.94	1.05	0.033	0.037	0.041
L1	1.50	1.75	2.00	0.060	0.069	0.078
H <sub>E</sub>	6.70	7.00	7.30	0.264	0.276	0.287
θ	0°	-	10°	0°	-	10°

### SOLDERING FOOTPRINT\*

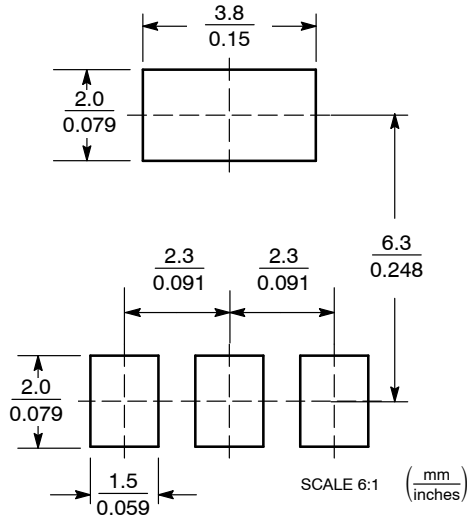

\*For additional information on our Pb-Free strategy and soldering details, please download the ON Semiconductor Soldering and Mounting Techniques Reference Manual, SOLDERRM/D.

# MC33269, NCV33269

## PACKAGE DIMENSIONS

### TO-220AB, SINGLE GAUGE T SUFFIX CASE 221AB-01 ISSUE O

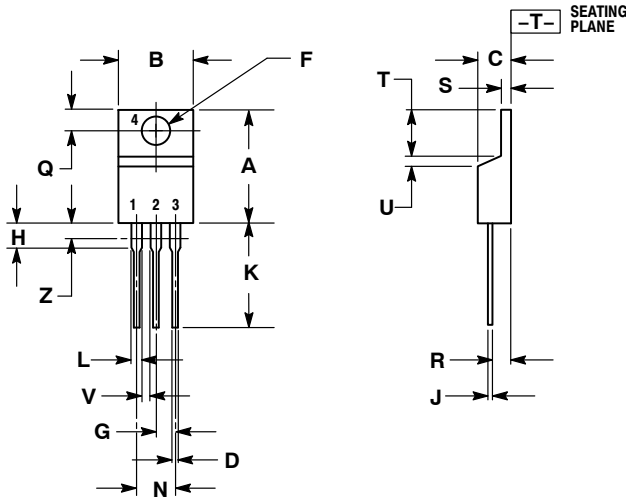

#### NOTES:

1. DIMENSIONING AND TOLERANCING PER ANSI Y14.5M, 1982.
2. CONTROLLING DIMENSION: INCH.
3. DIMENSION Z DEFINES A ZONE WHERE ALL BODY AND LEAD IRREGULARITIES ARE ALLOWED.

DIM	INCHES		MILLIMETERS	
	MIN	MAX	MIN	MAX
A	0.570	0.620	14.48	15.75
B	0.380	0.405	9.66	10.28
C	0.160	0.190	4.07	4.82
D	0.025	0.035	0.64	0.88
F	0.142	0.147	3.61	3.73
G	0.095	0.105	2.42	2.66
H	0.110	0.155	2.80	3.93
J	0.018	0.025	0.46	0.64
K	0.500	0.562	12.70	14.27
L	0.045	0.060	1.15	1.52
N	0.190	0.210	4.83	5.33
Q	0.100	0.120	2.54	3.04
R	0.080	0.110	2.04	2.79
S	0.020	0.055	0.508	1.39
T	0.235	0.255	5.97	6.47
U	0.000	0.050	0.00	1.27
V	0.045	---	1.15	---
Z	---	0.080	---	2.04

ON Semiconductor and are registered trademarks of Semiconductor Components Industries, LLC (SCILLC). SCILLC reserves the right to make changes without further notice to any products herein. SCILLC makes no warranty, representation or guarantee regarding the suitability of its products for any particular purpose, nor does SCILLC assume any liability arising out of the application or use of any product or circuit, and specifically disclaims any and all liability, including without limitation special, consequential or incidental damages. "Typical" parameters which may be provided in SCILLC data sheets and/or specifications can and do vary in different applications and actual performance may vary over time. All operating parameters, including "Typicals" must be validated for each customer application by customer's technical experts. SCILLC does not convey any license under its patent rights nor the rights of others. SCILLC products are not designed, intended, or authorized for use as components in systems intended for surgical implant into the body, or other applications intended to support or sustain life, or for any other application in which the failure of the SCILLC product could create a situation where personal injury or death may occur. Should Buyer purchase or use SCILLC products for any such unintended or unauthorized application, Buyer shall indemnify and hold SCILLC and its officers, employees, subsidiaries, affiliates, and distributors harmless against all claims, costs, damages, and expenses, and reasonable attorney fees arising out of, directly or indirectly, any claim of personal injury or death associated with such unintended or unauthorized use, even if such claim alleges that SCILLC was negligent regarding the design or manufacture of the part. SCILLC is an Equal Opportunity/Affirmative Action Employer. This literature is subject to all applicable copyright laws and is not for resale in any manner.

#### PUBLICATION ORDERING INFORMATION

##### LITERATURE FULFILLMENT:

Literature Distribution Center for ON Semiconductor  
P.O. Box 5163, Denver, Colorado 80217 USA  
Phone: 303-675-2175 or 800-344-3860 Toll Free USA/Canada  
Fax: 303-675-2176 or 800-344-3867 Toll Free USA/Canada  
Email: orderlit@onsemi.com

N. American Technical Support: 800-282-9855 Toll Free  
USA/Canada  
Europe, Middle East and Africa Technical Support:  
Phone: 421 33 790 2910  
Japan Customer Focus Center  
Phone: 81-3-5773-3850

ON Semiconductor Website: [www.onsemi.com](http://www.onsemi.com)

Order Literature: <http://www.onsemi.com/orderlit>

For additional information, please contact your local Sales Representative



Компания «ЭлектроПласт» предлагает заключение долгосрочных отношений при поставках импортных электронных компонентов на взаимовыгодных условиях!

Наши преимущества:

- Оперативные поставки широкого спектра электронных компонентов отечественного и импортного производства напрямую от производителей и с крупнейших мировых складов;
- Поставка более 17-ти миллионов наименований электронных компонентов;
- Поставка сложных, дефицитных, либо снятых с производства позиций;
- Оперативные сроки поставки под заказ (от 5 рабочих дней);
- Экспресс доставка в любую точку России;
- Техническая поддержка проекта, помощь в подборе аналогов, поставка прототипов;
- Система менеджмента качества сертифицирована по Международному стандарту ISO 9001;
- Лицензия ФСБ на осуществление работ с использованием сведений, составляющих государственную тайну;
- Поставка специализированных компонентов (Xilinx, Altera, Analog Devices, Intersil, Interpoint, Microsemi, Aeroflex, Peregrine, Syfer, Eurofarad, Texas Instrument, Miteq, Cobham, E2V, MA-COM, Hittite, Mini-Circuits, General Dynamics и др.);

Помимо этого, одним из направлений компании «ЭлектроПласт» является направление «Источники питания». Мы предлагаем Вам помощь Конструкторского отдела:

- Подбор оптимального решения, техническое обоснование при выборе компонента;
- Подбор аналогов;
- Консультации по применению компонента;
- Поставка образцов и прототипов;
- Техническая поддержка проекта;
- Защита от снятия компонента с производства.



#### Как с нами связаться

**Телефон:** 8 (812) 309 58 32 (многоканальный)

**Факс:** 8 (812) 320-02-42

**Электронная почта:** [org@eplast1.ru](mailto:org@eplast1.ru)

**Адрес:** 198099, г. Санкт-Петербург, ул. Калинина, дом 2, корпус 4, литера А.