

FEATURES

- High precision, 2-channel, isolated AMR angle sensor for redundant systems
- Angular range of 0° to 180°
- Typical angular error of 0.1°
- Analog sine and cosine outputs per channel
- Ratiometric output voltages
- Low thermal and lifetime drift
- Successive approximation register (SAR) analog-to-digital converter (ADC) or Σ - Δ ADC drive capable
- Magnetostrictive (MR) bridge temperature compensation mode
- Temperature range: -40°C to +150°C
- Supply voltage (V_{DD}) from 3 V to 5.5 V
- Minimum phase delay
- Available in a 16-lead SOIC package
- Qualified for automotive applications

APPLICATIONS

- Permanent magnet synchronous motor (PMSM) control and positioning
- Contactless angular measurement and detection
- Magnetic angular position sensing

GENERAL DESCRIPTION

The ADA4571-2 is a 2-channel anisotropic magneto resistive (AMR) sensor with integrated signal conditioning amplifiers and ADC drivers. The device produces analog outputs that indicate the angular position of the surrounding magnetic field.

Each channel consists of two die within one package: an AMR sensor and a variable gain instrumentation amplifier. The ADA4571-2 delivers clean and amplified cosine and sine output signals per channel related to the angle of a rotating magnetic field. The output voltage range is ratiometric to the supply voltage.

Each sensing channel contains two separated wheatstone bridges at a relative angle of 45° to one another. A rotating magnetic field parallel to the plane of the IC package delivers two sinusoidal output signals, with the double frequency of the angle, α , between the sensor and the magnetic field direction. Within a homogeneous field parallel to the plane of the IC package, the output signals are independent of airgap between the sensor and the magnet.

The ADA4571-2 is available in a 16-lead SOIC package.

Rev. 0

[Document Feedback](#)

Information furnished by Analog Devices is believed to be accurate and reliable. However, no responsibility is assumed by Analog Devices for its use, nor for any infringements of patents or other rights of third parties that may result from its use. Specifications subject to change without notice. No license is granted by implication or otherwise under any patent or patent rights of Analog Devices. Trademarks and registered trademarks are the property of their respective owners.

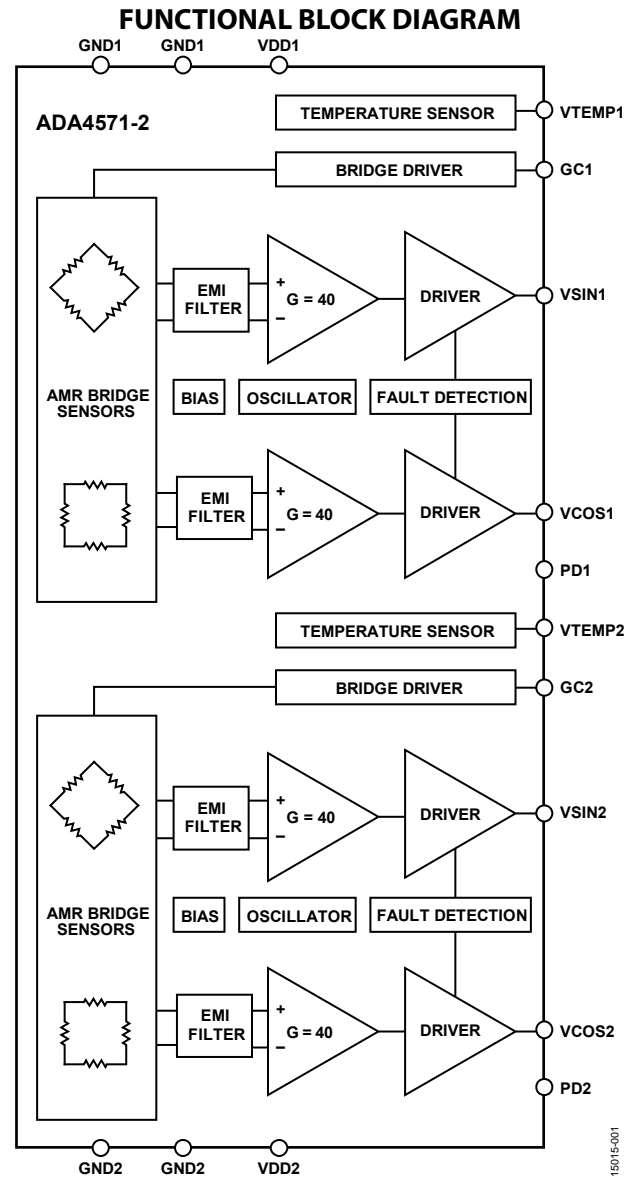

Figure 1.

PRODUCT HIGHLIGHTS

1. Contactless angular measurement.
2. Measures magnetic field direction rather than field intensity.
3. Minimum sensitivity to air gap variations.
4. Large working distance.
5. Excellent accuracy, even for weak saturation fields.
6. Minimal thermal and lifetime drift.
7. Negligible hysteresis.
8. Single-chip solution.

TABLE OF CONTENTS

Features	1	Pin Configuration and Function Descriptions.....	6
Applications.....	1	Typical Performance Characteristics	7
General Description	1	Theory of Operation	9
Functional Block Diagram	1	Applications Information	11
Product Highlights	1	Angle Calculation.....	11
Revision History	2	Connection to ECU	11
Specifications.....	3	Diagnostics.....	12
Magnetic Characteristics	3	Outline Dimensions	13
Electrical Characteristics	3	Ordering Guide	13
Absolute Maximum Ratings.....	5	Automotive Products.....	13
Thermal Resistance	5		
ESD Caution.....	5		

REVISION HISTORY

11/2016—Revision 0: Initial Version

SPECIFICATIONS

MAGNETIC CHARACTERISTICS

Table 1.

Parameter	Symbol	Min	Typ	Max	Unit	Test Conditions/Comments
MINIMUM MAGNETIC FIELD STRENGTH	H _{EXT}	25			kA/m	The stimulating magnetic field in the x-y sensor plane necessary to ensure the minimum error, as specified in this table and in Table 2
MAXIMUM ROTATIONAL FREQUENCY				30,000	rpm	

ELECTRICAL CHARACTERISTICS

−40°C ≤ T_A ≤ +150°C, V_{DD} = 3 V to 5.5 V, C_L = 10 nF to GND_X, R_L = 5 kΩ to GND_X; angle inaccuracies referred to homogenous magnetic field of 25 kA/m; output signals and offset voltages are related to the common-mode level of V_{DD}/2, unless otherwise noted.

Table 2.

Parameter	Symbol	Test Conditions/Comments	Min	Typ	Max	Unit
ANGULAR PERFORMANCE						
Angle Measurement Range			0		180	Degrees
Uncorrected Angular Error ¹	α _{UNCORR}	T _A = −40°C		±2	±7	Degrees
		T _A = 25°C		±2	±7	Degrees
		T _A = 150°C		±2	±7	Degrees
Single-Point Calibration Angular Error ^{2,3}	α _{CAL}	T _A = −40°C to +150°C, GC _X = GND _X		±0.5		Degrees
Dynamic Angular Error ⁴	α _{DYNAMIC}	T _A = −40°C to +150°C, GC _X = V _{DD}		±0.4		Degrees
		V _{DD} = 3 V, T _A = −40°C to +150°C, rotation frequency = 2000 rpm		±0.1	±0.5	Degrees
		V _{DD} = 5 V, T _A = −40°C to +150°C, rotation frequency = 2000 rpm		±0.1	±0.4	Degrees
OUTPUT PARAMETERS						
Peak-to-Peak Voltage	V _{PP}					
GC _X = GND _X		T _A = −40°C	63		75	% V _{DD}
		T _A = 25°C	41		53	% V _{DD}
		T _A = 125°C	21		33	% V _{DD}
		T _A = 150°C	18		30	% V _{DD}
GC _X = V _{DDX}		T _A = −40°C	56		77	% V _{DD}
		T _A = 25°C	52		72	% V _{DD}
		T _A = 125°C	38		57	% V _{DD}
		T _A = 150°C	35		55	% V _{DD}
Output Voltage Range	V _{O_SWING}	VSIN1, VSIN2, VCOS1, and VCOS2; normal operation	7		93	% V _{DD}
Output Voltage Low	V _{OL}	VSIN1, VSIN2, VCOS1, or VCOS2; broken bond wire detected			5	% V _{DD}
Output Referred Offset Voltage	V _{OFFSET}	GC _X = V _{DDX}			3.75	% V _{DD}
		GC _X = GND _X			3.75	% V _{DD}
Amplitude Synchronism Error ⁵	k		−1	±0.1	+1	% peak
Delay Time	t _{DEL}	Rotation frequency = 30,000 rpm		2		μs
Phase Error ⁶	Φ _{ERR}	Rotation frequency = 30,000 rpm		0.8		Degrees
Orthogonality Error ³	OE			0.025		Degrees
Output Noise	V _{NOISE}	Bandwidth (BW) = 80 kHz, referred to output (RTO)		500		μV rms
Output Series Resistance	R _O	Normal operation, PD _X = GND _X		60		Ω
		PD _X = V _{DD}	63			kΩ
Output −3 dB Cutoff Frequency ³	f _{−3 dB}	Amplifier BW, C _L = 10 pF		100		kHz

Parameter	Symbol	Test Conditions/Comments	Min	Typ	Max	Unit
Power Supply Rejection Ratio ³	PSRR	Measured as a dc output variation from $V_{DD}/2$, $V_{DD} = 3\text{ V to }5.5\text{ V}$, $R_L = 200\text{ k}\Omega$ to GNDx, $GCx = GNDx$ or V_{DD}		80		dB
Output Short-Circuit Current Per Channel	I_{SC}	Short to GNDx per pin ($VSINx, VCOSx$) per channel	15	20		mA
		Short to VDDx per pin ($VSINx, VCOSx$) per channel	-15	-18		mA
POWER SUPPLY						
Supply Voltage	V_{DD}		3		5.5	V
Quiescent Supply Current Per Channel	I_{SY}	$PDx = GNDx, GCx = GNDx$, no load, VDD1 and VDD2	3.5	4.5	6.5	mA
		$PDx = GNDx, GCx = V_{DD}$, no load, VDD1 and VDD2			7	mA
Power-Up Time	t_{PWRUP}	$PDx = V_{DD}$, no load, VDD1 and VDD2			15	μA
		To 98% of desired output level after V_{DD} is reached			150	μs
		To 98% of desired output level after PDx cycling			100	μs
DIGITAL INPUTS						
Input Bias Current GC1, GC2	I_{B_GC}	For GCx mode control pin, $GCx = GNDx$			30	μA
		For GCx mode control pin, $GCx = V_{DD}$		3		μA
PD1, PD2	I_{B_PD}	For PDx pin, $PDx = GNDx$		3		μA
		For PDx pin, $PDx = V_{DD}$			30	μA
Input Voltage (GC1, GC2, PD1 and PD2)	V_{IH} V_{IL}	High	1.4			V
		Low			0.35	V
TEMPERATURE SENSOR (VTEMP1, VTEMP2)						
Error Over Temperature	T_{ERR}			5		$^{\circ}\text{C}$
Temperature Voltage Range	T_{RANGE}	$T_A = -40^{\circ}\text{C to }+150^{\circ}\text{C}$	0		82	% V_{DD}
Temperature Coefficient VTEMPx	Tempco			3.173		mV/V/ $^{\circ}\text{C}$
Output Voltage		$T_A = 25^{\circ}\text{C}$	18		40	% V_{DD}
Output Impedance		Buffered output		50		Ω
Load Capacitance		Optional load capacitance	0		22	nF
Short-Circuit Current	I_{SC_VTEMP}	Short-circuit to VDDx or GNDx	2			mA
LOAD CAPACITOR						
External Load Capacitance	C_L	Between $VSINx$ to GNDx and $VCOSx$ to GNDx; solder close to package			10	nF

¹ Q_{UNCORR} is the total mechanical angular error after arctan computation. This parameter is 100% production tested at 25°C and 150°C. This error includes all sources of error over temperature before calibration. Error components such as offset, amplitude synchronism, amplitude synchronism drift, thermal offset drift, phase error, hysteresis, orthogonality error, and noise are included.

² Q_{CAL} is the total mechanical angular error after arctan computation. This error includes all sources of error over temperature after an initial offset (nulling) is performed at $T_A = 25^{\circ}\text{C}$. Error components such as amplitude synchronism drift, amplifier gain matching, thermal offset drift, phase error, hysteresis, orthogonality error, and noise are included.

³ Guaranteed through characterization.

⁴ $Q_{DYNAMIC}$ is the total mechanical angular error after arctan computation. This parameter is 100% production tested. This error includes all sources of error over temperature after a continuous background calibration is performed to correct offset and amplitude synchronism errors. Error components such as phase error, hysteresis, orthogonality error, noise, and lifetime drift are included.

⁵ Peak-to-peak amplitude mismatch. $k = 100 \times VSINx/VCOSx$.

⁶ Rotation frequency dependent phase error, after offset correction, amplitude calibration, and arctan calculation.

ABSOLUTE MAXIMUM RATINGS

Table 3.

Parameter	Rating
Operating Temperature Range	-40°C to +150°C
Storage Temperature Range	-65°C to +150°C
Supply Voltage (V_{DD}) ¹ Range	-0.3 V to +6 V
Output Short-Circuit Duration to GNDx or VDDx	Indefinite
VTEMPx Short Circuit to GNDx or VDDx	Indefinite
ESD	
Human Body Model (HBM) ²	4000 V
Machine Model (MM) ³	300 V
Charge Device Model (CDM) ⁴	1250 V

¹ GCx or PDx at VDDx + 0.3 V.

² The applicable standard is ESDA/JEDEC JS-001-2011.

³ The applicable standard is JESD22-A115.

⁴ The applicable standard is JESD22-C101.

Stresses at or above those listed under Absolute Maximum Ratings may cause permanent damage to the product. This is a stress rating only; functional operation of the product at these or any other conditions above those indicated in the operational section of this specification is not implied. Operation beyond the maximum operating conditions for extended periods may affect product reliability.

THERMAL RESISTANCE

Thermal performance is directly linked to printed circuit board (PCB) design and operating environment. Careful attention to PCB thermal design is required.

θ_{JA} is the natural convection junction to ambient thermal resistance measured in a one cubic foot sealed enclosure.

Table 4. Thermal Resistance

Package Type	θ_{JA}	Unit
R-16-S ¹	105	°C/W

¹ For more information on thermal test methods and environmental conditions, refer to JESD51-2.

ESD CAUTION



ESD (electrostatic discharge) sensitive device. Charged devices and circuit boards can discharge without detection. Although this product features patented or proprietary protection circuitry, damage may occur on devices subjected to high energy ESD. Therefore, proper ESD precautions should be taken to avoid performance degradation or loss of functionality.

PIN CONFIGURATION AND FUNCTION DESCRIPTIONS

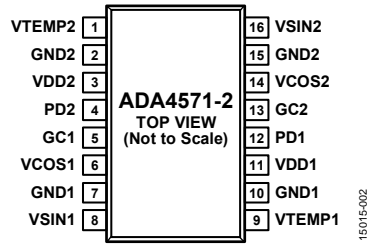

Figure 2. Pin Configuration

Table 5. Pin Function Descriptions

Pin No.	Mnemonic	Description
1	VTEMP2	Temperature Output Channel 2. The VTEMP2 pin must be left open when not in use.
2	GND2	Ground Channel 2.
3	VDD2	Supply, Channel 2.
4	PD2	Power-Down, Active High, Channel 2.
5	GC1	Gain Control Mode, Active High, Channel 1.
6	VCOS1	Analog Cosine Output, Channel 1.
7	GND1	Ground Channel 1.
8	VSIN1	Analog Sine Output, Channel 1.
9	VTEMP1	Temperature Output Channel 1. The VTEMP1 pin must be left open when not in use.
10	GND1	Ground Channel 1.
11	VDD1	Supply, Channel 1.
12	PD1	Power-Down, Active High, Channel 1.
13	GC2	Gain Control Mode, Active High, Channel 2.
14	VCOS2	Analog Cosine Output, Channel 2.
15	GND2	Ground Channel 2.
16	VSIN2	Analog Sine Output, Channel 2.

TYPICAL PERFORMANCE CHARACTERISTICS

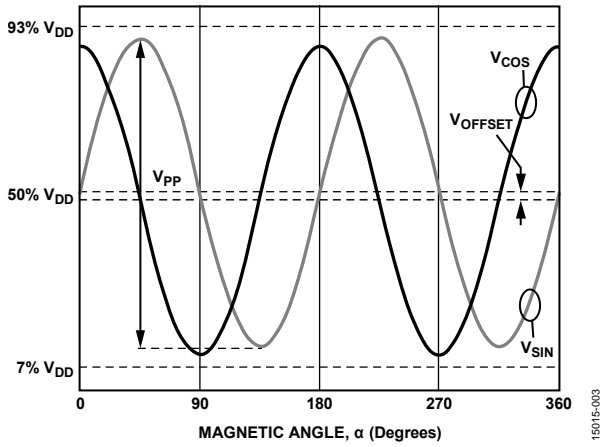

Figure 3. Raw Output Waveforms

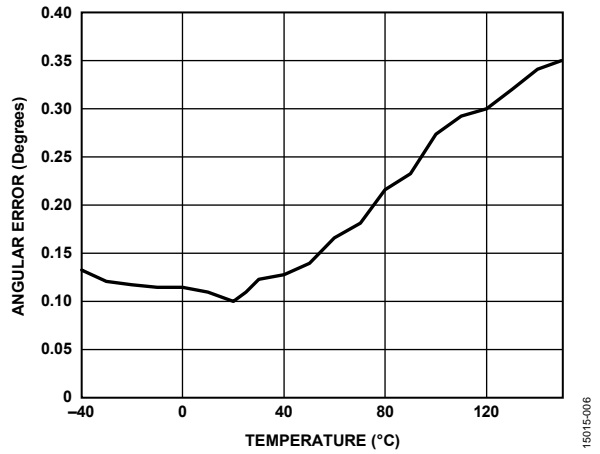

Figure 6. Single-Point Calibration Angular Error, Assuming Homogeneous Aligned Magnetic Field over One Channel

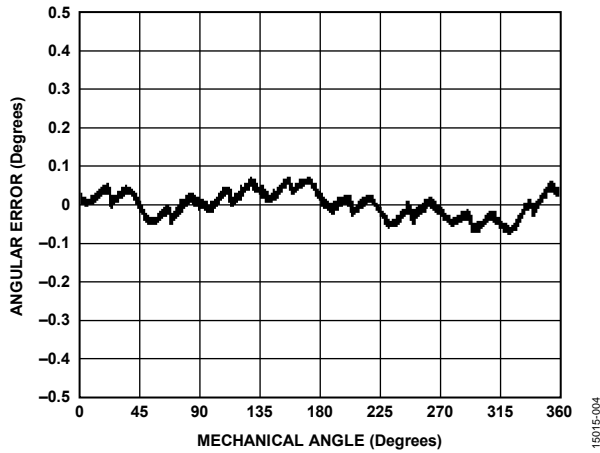

Figure 4. Error Waveform After Offset and Amplitude Correction, Assuming Homogeneous Aligned Magnetic Field Over One Channel

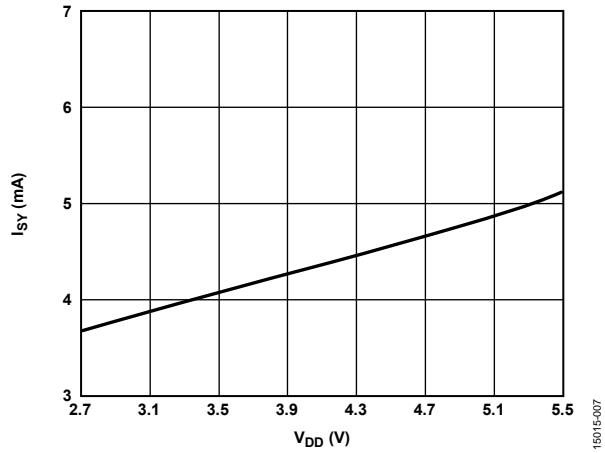

Figure 7. Supply Current (I_{SY}) Per Channel vs. Supply Voltage (V_{DD}), $T_A = 25^\circ\text{C}$

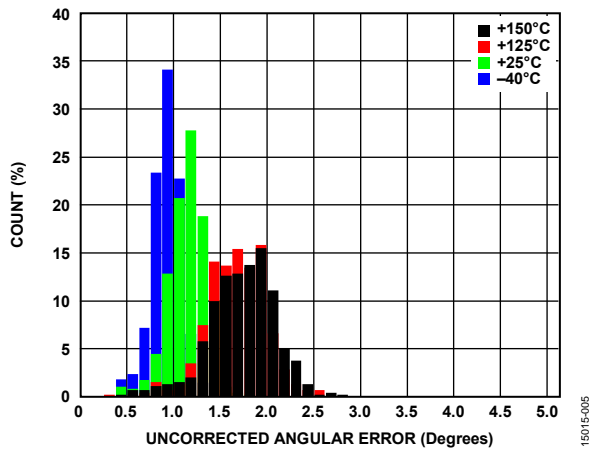

Figure 5. Uncorrected Angular Error

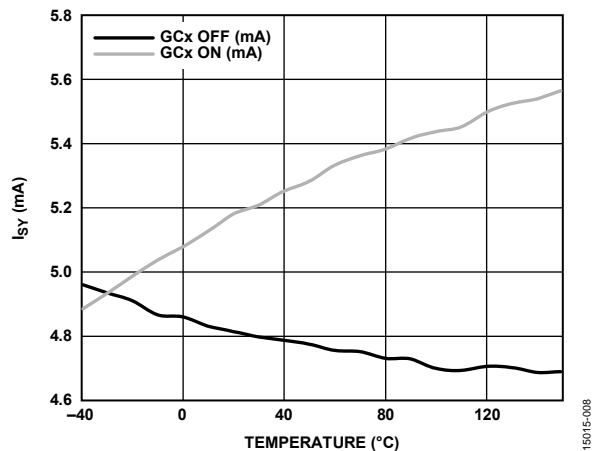

Figure 8. Supply Current (I_{SY}) Per Channel vs. Temperature, $V_{DD} = 5\text{V}$

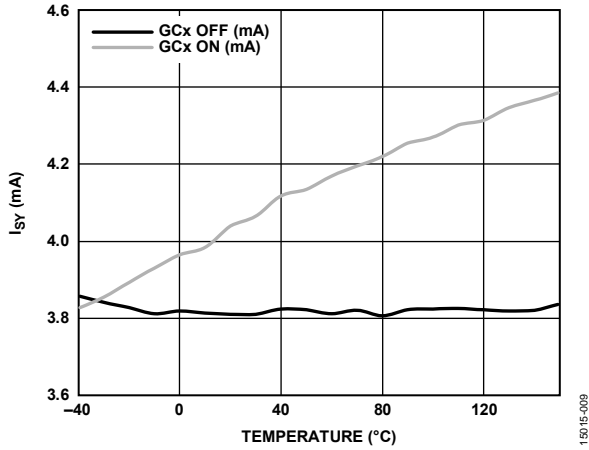

Figure 9. Supply Current (I_{SY}) Per Channel vs. Temperature, $V_{DD} = 3 V$

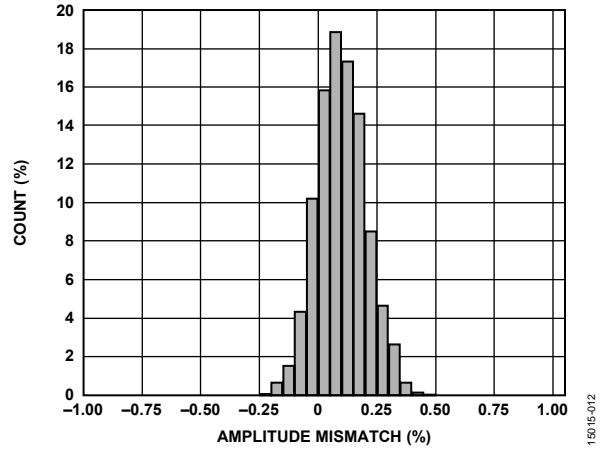

Figure 12. V_{SINx} to V_{COSx} Amplitude Mismatch Per Channel

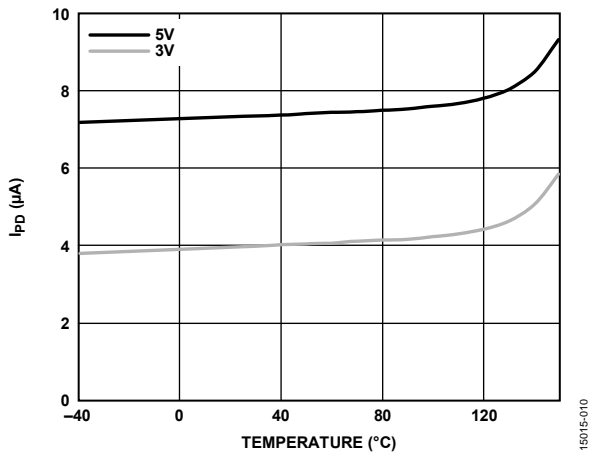

Figure 10. Power-Down Current (I_{PD}) Per Channel vs. Temperature Per Channel

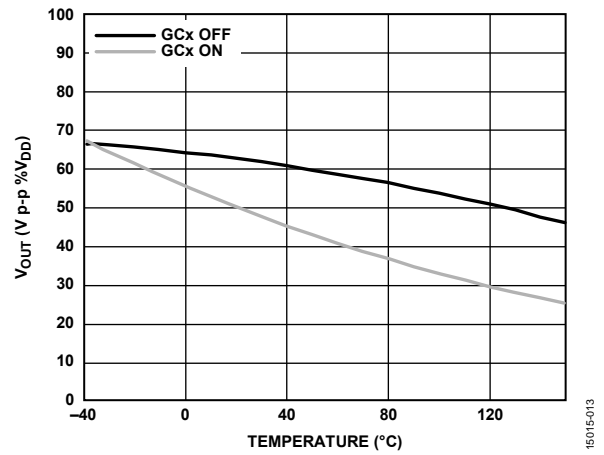

Figure 13. Peak-to-Peak Output Voltage (V_{SIN} and V_{COS}) vs. Temperature

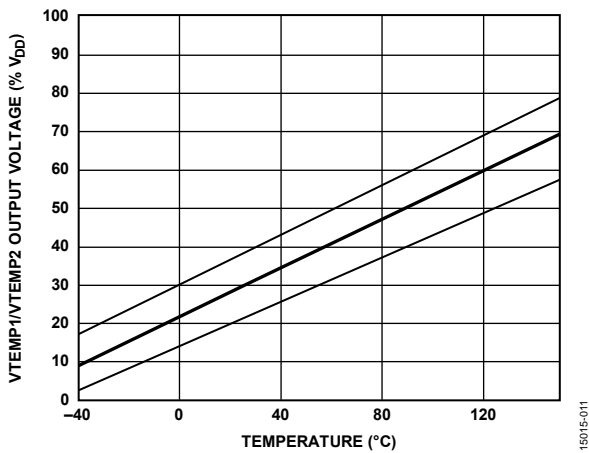

Figure 11. V_{TEMP1}/V_{TEMP2} Output Voltage vs. Temperature

THEORY OF OPERATION

The ADA4571-2 is an AMR sensor with integrated signal conditioning amplifiers and Σ - Δ ADC drivers. The ADA4571-2 produces two analog outputs, sine and cosine, that indicate the angular position of the surrounding magnetic field.

Sensitec GmbH developed the ADA4571-2 AMR technology.



Figure 14 shows the sine channel, consisting of an AMR sensor element and the supporting functions for control, filtering, buffering, and signal amplification. A reference voltage that is proportional to the supply voltage is generated by the device and controls the supply voltage of the sensor bridges. For noise and electromagnetic compatibility (EMC) suppression purposes, the bridge supply is low-pass filtered. The bridge output voltages are amplified by a constant factor ($G = 40$, gain control mode disabled) and buffered. The single-ended outputs are biased around a common-mode voltage of $V_{DD}/2$ and are capable of driving the inputs of an external ADC referenced to the supply voltage.

For optimum use of the ADC input range, the cosine and sine output voltages track the supply voltage, ensuring a ratiometric configuration. To achieve high signal performance, both output

signals are carefully matched in both amplitude and phase. The amplifier bandwidth is sufficient to ensure low phase delay at the maximum specified rotation speed.

Electromagnetic interference (EMI) filters at the sensor outputs and between the first and second stages reject unwanted noise and interference from appearing in the signal band.

The architecture of the instrumentation amplifier consists of precision, low noise, zero drift amplifiers that feature a proprietary chopping technique. This chopping technique offers a low input offset voltage of $0.3 \mu\text{V}$ (typical) and an input offset voltage drift of $0.02 \mu\text{V}/^\circ\text{C}$ (typical). The zero drift design also features chopping ripple suppression circuitry, which removes glitches and other artifacts caused by chopping.

Offset voltage errors caused by common-mode voltage swings and power supply variations are also corrected by the chopping technique, resulting in a dc common-mode rejection ratio that is greater than 150 dB. The amplifiers feature low broadband noise of $22 \text{ nV}/\sqrt{\text{Hz}}$ and no $1/f$ noise component. These features are ideal for amplification of the low level AMR bridge signals for high precision sensing applications.

In addition, extensive diagnostics are integrated on chip to self check sensor and IC conditions.

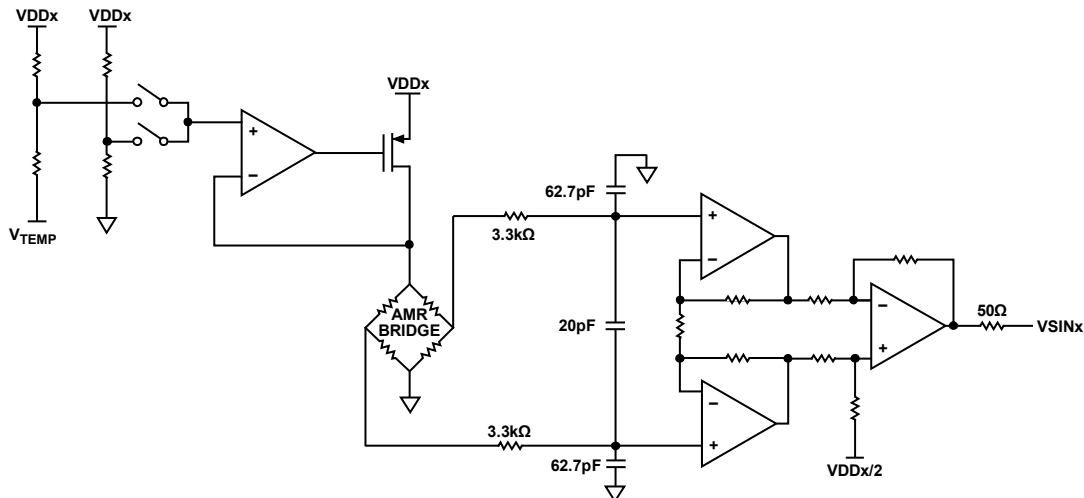

Figure 14. Detailed Internal Diagram of the ADA4571-2, Single Sine Channel

15015-014

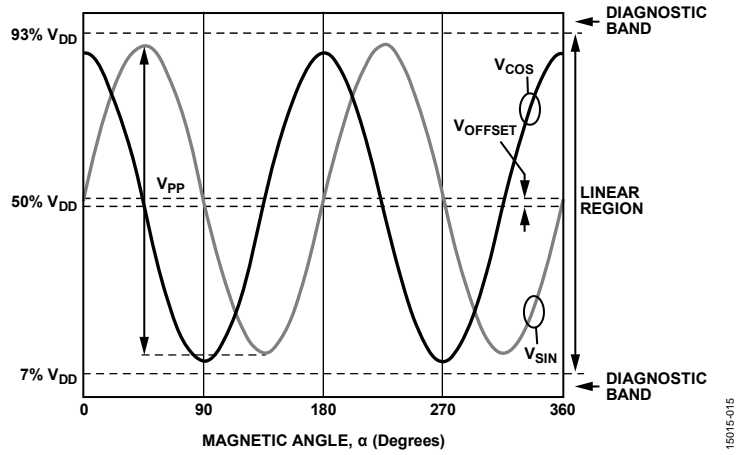

Figure 15. Typical Output Waveforms; Single-Channel Sine and Cosine vs. Magnetic Angle

APPLICATIONS INFORMATION

The integrated AMR sensor is designed for applications with a separate processing IC or electronic control unit (ECU) containing a Σ - Δ ADC with references connected to the supply voltage. With the ADC input resolution related to V_{DD} in the same way as the AMR sensor output, the system is inherently ratiometric and the signal dependency on supply voltage changes is minimized.

ANGLE CALCULATION

To calculate angle from the output of the AMR device, use the trigonometric function, arctangent2. The arctangent2 function is a standard arctangent function with additional quadrant information to extend the output from the magnetic angle range of -90° to $+90^\circ$ to the magnetic angle range of -180° to $+180^\circ$. Because of the sensing range of AMR technology, this calculated magnetic angle repeats over each pole of the magnet. For a simple dipole magnet, the following equation reports absolute angle over 180° mechanical:

$$\alpha = \frac{\arctan\left(\frac{V_{SIN}}{V_{COS}}\right)}{2}$$

CONNECTION TO ECU

Because of the limited driving capability of the ADA4571-2 output, minimize the length of printed circuit board (PCB) traces between the ADA4571-2 and other ICs. Shielding of the signal lines is recommended. Match the load capacitors and resistors for best angular accuracy. Add bandwidth limitation filters related to the sampling frequency of the system in front of the ADC inputs to reduce noise bandwidth.

The load resistors on $VCOSx$ and $VSINx$ are the same as the input filter of the ADC. Use the processor for arctan and offset calculations, offset storage, and additional calibration.

VTEMPx Output Pin

A proportional to absolute temperature circuit provides a voltage output at the VTEMPx pin for temperature monitoring or temperature calibration purposes. The output voltage is ratiometric to the supply voltage, enabling the interface with an ADC that uses the supply voltage to generate the reference voltage. The VTEMPx pin must be left open when not in use.

To achieve maximum accuracy from the VTEMPx output voltage, perform an initial calibration at a known, controlled temperature. Then, use the following equation to extract temperature information:

$$T_{VTEMP} = \frac{\left(\frac{V_{TEMP}}{V_{DD}}\right) - \left(\left(\frac{V_{CAL}}{V_{DD}}\right) - T_{CAL} \times Tempco\right)}{TC_{VTEMP}}$$

where:

T_{VTEMP} is the calculated temperature ($^\circ\text{C}$) from the VTEMPx output voltage.

V_{TEMP} is the VTEMPx output voltage during device operation.

V_{DD} is the supply voltage.

V_{CAL} is the VTEMPx output voltage during calibration at a controlled temperature.

T_{CAL} is the controlled temperature during calibration.

$Tempco$ is the temperature coefficient of the internal circuit; see the Specifications section for the exact value.

Gain Control Mode

Activate gain control (GCx) enable mode by connecting the GCx pin to the VDDx pin. In this mode, the AMR bridge sensor amplitude outputs are compensated to reduce temperature variation. This compensation results in higher and controlled output voltage levels, boosts the system dynamic range, and eases the system design task. If the GCx pin is left floating, a weak pull-up resistor ensures that the GC mode is enabled as a default condition. The GC mode can also be used as a sensor self diagnostic by comparing the sine and cosine amplitude outputs when enabled and disabled, such as a radius check. Device failure is indicated by the radius remaining unchanged.

Power-Down Mode

Activate power-down mode by connecting the PDx pin to the VDDx pin. In this mode, the device shuts down and the output pins are set to high impedance to avoid current consumption across the load resistors. The VTEMPx output is connected to GNDx through a pull-down resistor. Enter power-down mode with $GCx = V_{DD}$ or $GCx = GNDx$. An internal pull-down resistor ensures that the device remains active if the PDx pin is left floating.

Power Consumption

Worst case quiescent power occurs when the supply current runs at the specified maximum of 14 mA and when the ADA4571-2 is run at the maximum V_{DD} of 5.5 V, resulting in a worst case quiescent power of 77 mW.

The power consumption is dependent on V_{DD}, temperature, load resistance (R_L), load capacitance (C_L), and frequency of the rotating magnetic field. It is recommended to connect R_L and C_L to ground. The output voltages are protected against short circuits to the VDDx pin or ground by current limitation within the given time duration. Placing the device 180° rotated into the socket may lead to damage if the supply current is not limited to 100 mA.

Offset of Signal Outputs

The single-ended output signals are referenced to V_{DD}/2 and are generated internally on chip. Offsets originate from matching inaccuracies and other imperfections during the production process. For tight tolerances, it is required to match the external loads for VSINx and VCOSx to each other. For ESD and EMC protection, the outputs contain a series resistance of 60 Ω. A large output load resistance minimizes the influence of this series resistance.

Signal Dependence on Air Gap Distance

The device measures the direction of the external magnetic field within the x-y plane. This measurement result is widely independent of the field strength, if it is greater than the specified minimum value of 25 kA/m. Within a homogeneous field in the x-y direction, the result is independent of the placement in the z direction (air gap). The nominal z distance of the internal x-y plane to the top surface of the plastic package is 0.400 mm.

DIAGNOSTICS

Broken Bond Wire Detection

The ADA4571-2 includes circuitry to detect broken bond wire conditions between the AMR sensor and the instrumentation amplifier. The detection circuitry consists of current sources and window comparators placed on the signal connections between the AMR sensor and the ASIC. The purpose of the current sources is to pull the signal node outside of the normal operating region in the event of an open bond wire between the AMR sensor and

the ASIC. The purpose of the window comparators is to detect when the signal from the AMR sensor is outside of the normal operating region. When the comparators detect that the signal nodes are outside of the normal operating region, the circuit pulls the VSINx and/or VCOSx node to ground to indicate the fault to the host controller.

In addition to the active circuitry, there are applications recommendations, such as the use of pull-up and pull-down resistors, which detect broken bond wires by pulling nodes outside of the defined operating regions. A broken bond wire at VTEMPx, VCOSx, or VSINx interrupts the corresponding outputs. To ensure that the output enters into a known state if there is a broken bond wire on these pins, connect a 200 kΩ pull-down resistor at these pins. Pulling these nodes outside of the normal operating region signals a fault to the host controller.

Short-Circuit Condition to GNDx or VDDx

In the event of a short-circuit condition, the output voltages are pulled to the GNDx pin or the VDDx pin.

Short Circuit Between Sine and Cosine Sensor Outputs

In the event of a short circuit between sensor outputs, the device output voltages are tied to the output common-mode voltage. A gross angular error is detected in the microcontroller.

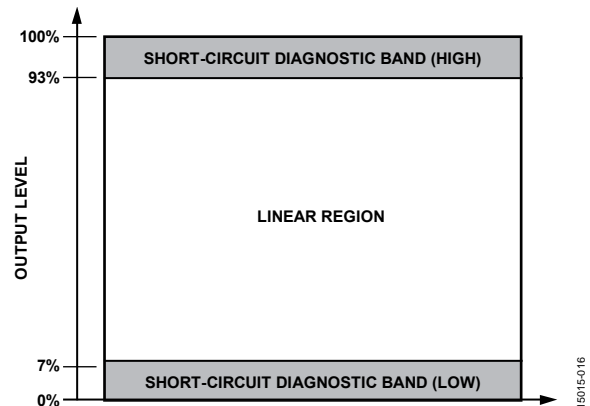

Figure 16. Output Span Classification During Short-Circuit Diagnostic Condition

Table 6. Diagnostic Cases

Fault Description	Output Conditions	Alert
Broken Bond Wire Between the Internal MR Sensor and the ASIC	Broken bond wire detection is activated; the broken channel(s), VSINx or VCOSx, are pulled to GNDx	Diagnostic region violation
Broken Bond Wire at the PDx Pin	Device remains functional	No alert
Broken Bond Wire at the GCx Pin	Gain control is activated	Possible change in output amplitude
Output Short Circuit to GNDx	Shorted channel is pulled to GNDx	Diagnostic region violation
Output Short Circuit to VDDx	Shorted channel is pulled to VDDx	Diagnostic region violation

OUTLINE DIMENSIONS

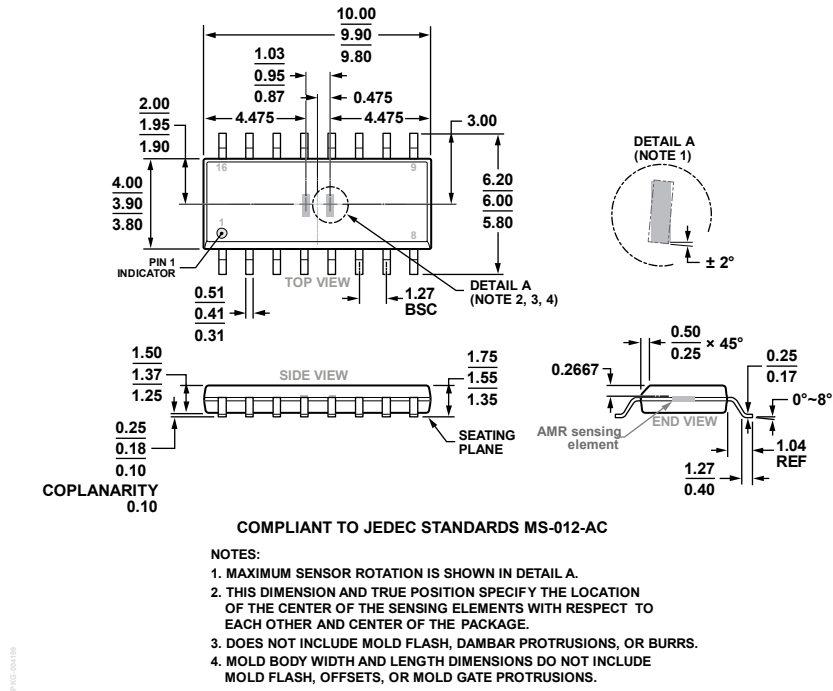

Figure 17. 16-Lead Standard Small Outline Package [SOIC_N]
Narrow Body
(R-16-S)
Dimensions shown in millimeters

ORDERING GUIDE

Model ^{1,2}	Temperature Range	Package Description	Package Option
ADA4571-2WHRZ-RL	-40°C to +150°C	16-Lead Standard Small Outline Package [SOIC_N]	R-16-S
EVAL-ADA4571-2EBZ		Evaluation Board	

¹ Z = RoHS Compliant Part.
² W = Qualified for Automotive Applications.

AUTOMOTIVE PRODUCTS

The ADA4571-2W model is available with controlled manufacturing to support the quality and reliability requirements of automotive applications. Note that this automotive model may have specifications that differ from the commercial models; therefore, designers should review the Specifications section of this data sheet carefully. Only the automotive grade products shown are available for use in automotive applications. Contact your local Analog Devices account representative for specific product ordering information and to obtain the specific Automotive Reliability reports for this model.



Компания «ЭлектроПласт» предлагает заключение долгосрочных отношений при поставках импортных электронных компонентов на взаимовыгодных условиях!

Наши преимущества:

- Оперативные поставки широкого спектра электронных компонентов отечественного и импортного производства напрямую от производителей и с крупнейших мировых складов;
- Поставка более 17-ти миллионов наименований электронных компонентов;
- Поставка сложных, дефицитных, либо снятых с производства позиций;
- Оперативные сроки поставки под заказ (от 5 рабочих дней);
- Экспресс доставка в любую точку России;
- Техническая поддержка проекта, помощь в подборе аналогов, поставка прототипов;
- Система менеджмента качества сертифицирована по Международному стандарту ISO 9001;
- Лицензия ФСБ на осуществление работ с использованием сведений, составляющих государственную тайну;
- Поставка специализированных компонентов (Xilinx, Altera, Analog Devices, Intersil, Interpoint, Microsemi, Aeroflex, Peregrine, Syfer, Eurofarad, Texas Instrument, Miteq, Cobham, E2V, MA-COM, Hittite, Mini-Circuits, General Dynamics и др.);

Помимо этого, одним из направлений компании «ЭлектроПласт» является направление «Источники питания». Мы предлагаем Вам помощь Конструкторского отдела:

- Подбор оптимального решения, техническое обоснование при выборе компонента;
- Подбор аналогов;
- Консультации по применению компонента;
- Поставка образцов и прототипов;
- Техническая поддержка проекта;
- Защита от снятия компонента с производства.



Как с нами связаться

Телефон: 8 (812) 309 58 32 (многоканальный)

Факс: 8 (812) 320-02-42

Электронная почта: org@eplast1.ru

Адрес: 198099, г. Санкт-Петербург, ул. Калинина, дом 2, корпус 4, литера А.