

■ OUTLINE

The R1160N Series are voltage regulator ICs with high output voltage accuracy, low supply current, and low ON-resistance by CMOS process. Each of these voltage regulator ICs consists of a voltage reference unit, an error amplifier, resistors for setting Output Voltage, a current limit circuit, and a chip enable circuit.

These ICs perform with low dropout voltage and a chip enable function. To prevent the destruction by over current, current limit circuit is included. The R1160N Series have 3-mode. One is standby mode with CE or standby control pin. Other two modes are realized with ECO pin™. Fast Transient Mode (FT mode) and Low Power Mode (LP mode) are alternative with ECO pin™. Consumption current is reduced to 1/10 at Low Power Mode compared with Fast Transient Mode. Output voltage is maintained between FT mode and LP mode.

The output voltage of these ICs is internally fixed with high accuracy. Since the package for these ICs is SOT-23-5 package, high density mounting of the ICs on boards is possible.

■ FEATURES

- Ultra-Low Supply Current..... TYP. 3.5μA(Low Power Mode, V_{OUT}≤1.5V),
..... TYP. 40μA (Fast Transient Mode)
- Standby Mode TYP. 0.1μA
- Low Dropout Voltage TYP. 0.30V(I_{OUT}=200mA Output Voltage=1.0V Type)
..... TYP. 0.20V(I_{OUT}=200mA Output Voltage=1.5V Type)
..... TYP. 0.14V(I_{OUT}=200mA Output Voltage=3.0V Type)
- High Ripple Rejection TYP. 70dB(f=1kHz, FT Mode)
- Low Temperature-Drift Coefficient of Output Voltage TYP. ±100ppm/°C
- Excellent Line Regulation TYP. 0.05%/V
- High Output Voltage Accuracy..... ±2.0%(±3.0% at LP Mode)
- Small Package SOT-23-5(Super Mini-mold)
- Output Voltage..... Stepwise setting with a step of 0.1V in the range of 0.8V to 3.3V is possible
- Input Voltage MIN. 1.4V
- Built-in fold-back protection circuit.....TYP. 50mA (Current at short mode)

■ APPLICATIONS

- Precision Voltage References.
- Power source for electrical appliances such as cameras, VCRs and hand-held communication equipment.
- Power source for battery-powered equipment.

■ BLOCK DIAGRAM

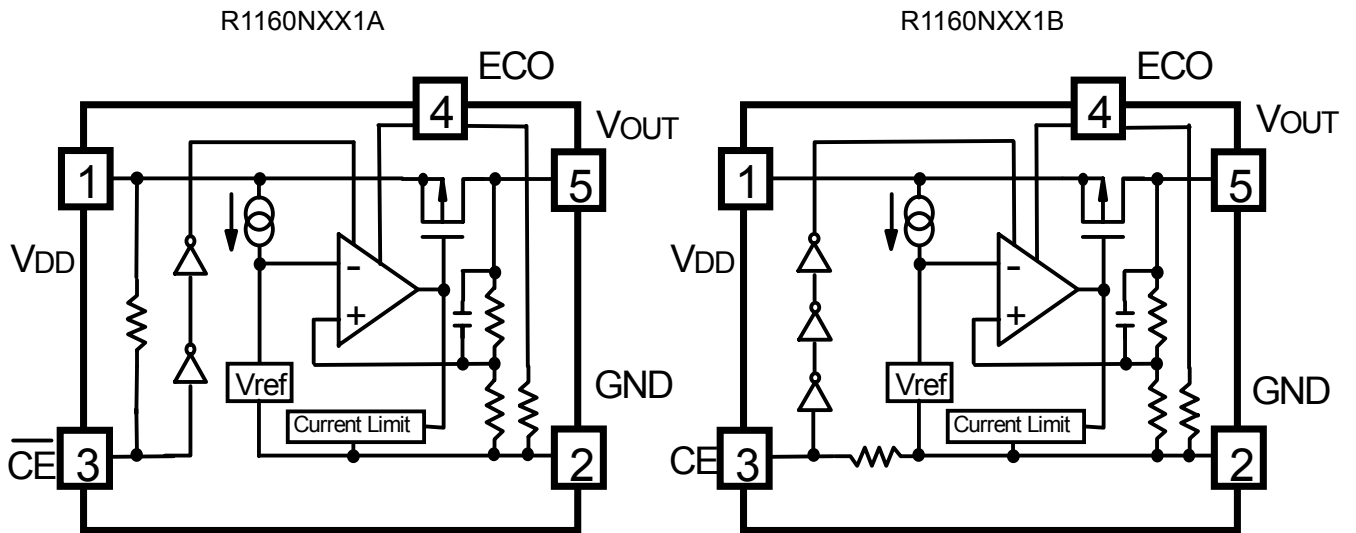

■ SELECTION GUIDE

The output voltage, chip enable polarity, and the taping type for the ICs can be selected at the user's request. The selection can be available by designating the part number as shown below;

R1160NXX1X-XX ←Part Number
 ↑ ↑ ↑ ↑
 a b c d

Code	Contents
a	Designation of Package Type : N:SOT-23-5 (Mini-mold)
b	Setting Output Voltage (V_{OUT}) : Stepwise setting with a step of 0.1V in the range of 0.8V to 3.3V is possible.
c	Designation of Chip Enable Option : A: "L" active type. B: "H" active type.
d	Designation of Taping Type : Refer to Taping Specifications; TR type is the standard direction.

■ PIN CONFIGURATION

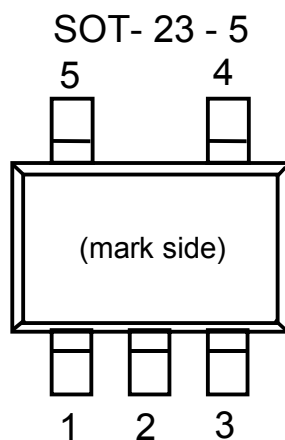

■ PIN DESCRIPTION

Pin No.	Symbol	Description
1	V _{DD}	Input Pin
2	GND	Ground Pin
3	$\overline{\text{CE}}$ or CE	Chip Enable Pin
4	ECO	MODE alternative pin
5	V _{OUT}	Output pin

■ ABSOLUTE MAXIMUM RATINGS

Item	Symbol	Rating	Unit
Input Voltage	V _{IN}	6.5	V
Input Voltage(ECO Pin)	V _{ECO}	-0.3 ~ V _{IN} +0.3	V
Input Voltage($\overline{\text{CE}}$ /CE Pin)	V _{CE}	-0.3 ~ V _{IN} +0.3	V
Output Voltage	V _{OUT}	-0.3 ~ V _{IN} +0.3	V
Output Current	I _{OUT}	250	mA
Power Dissipation	P _D	250	mW
Operating Temperature Range	T _{opt}	-40 ~ 85	°C
Storage Temperature Range	T _{stg}	-55 ~ 125	°C

■ ELECTRICAL CHARACTERISTICS

● R1160NXX1A

TopT=25°C

Symbol	Item	Conditions	MIN.	TYP.	MAX.	Unit
V _{OUT}	Output Voltage	V _{IN} = Set V _{OUT} +1V V _{ECO} =V _{IN} 1μA ≤ I _{OUT} ≤ 30mA(Note 1)	V _{OUT} ×0.98 (-30mV)		V _{OUT} ×1.02 (30mV)	V
		V _{IN} = Set V _{OUT} +1V V _{ECO} =GND 1μA ≤ I _{OUT} ≤ 30mA(Note 2)	V _{OUT} ×0.97 (-45mV)		V _{OUT} ×1.03 (45mV)	V
I _{OUT}	Output Current	V _{IN} - V _{OUT} = 0.5V V _{IN} ≥ 1.5V, V _{OUT} ≤ 1.0V	200			mA
ΔV _{OUT} /ΔI _{OUT}	Load Regulation(FT Mode)	V _{IN} = Set V _{OUT} +1V, V _{ECO} =V _{IN} 1mA ≤ I _{OUT} ≤ 200mA		20	40	mV
ΔV _{OUT} /ΔI _{OUT}	Load Regulation(LP Mode)	V _{IN} = Set V _{OUT} +1V, V _{ECO} =GND 1mA ≤ I _{OUT} ≤ 100mA		10	40	mV
V _{DIF}	Dropout Voltage	Refer to the ELECTRICAL CHARACTERISTICS by OUTPUT VOLTAGE				
I _{SS1}	Supply Current(FT Mode)	V _{IN} = Set V _{OUT} +1V V _{ECO} =V _{IN}		40	70	μA
I _{SS2}	Supply Current(LP Mode)	V _{IN} = Set V _{OUT} +1V, V _{OUT} ≤ 1.5V, V _{ECO} =GND		3.5	6.0	μA
		V _{IN} = Set V _{OUT} +1V V _{OUT} ≥ 1.6V, V _{ECO} =GND		4.5	8.0	μA
I _{standby}	Supply Current (Standby)	V _{IN} = V _{CE} = Set V _{OUT} +1V		0.1	1.0	μA
ΔV _{OUT} /ΔV _{IN}	Line Regulation(FT Mode)	Set V _{OUT} +0.5V ≤ V _{IN} ≤ 6V I _{OUT} = 30mA, V _{ECO} =V _{IN}		0.05	0.20	%/V
ΔV _{OUT} /ΔV _{IN}	Line Regulation(LP Mode)	Set V _{OUT} +0.5V ≤ V _{IN} ≤ 6V I _{OUT} = 30mA, V _{ECO} =GND		0.10	0.30	%/V
RR	Ripple Rejection(FT Mode)	f = 1kHz, Ripple 0.2Vp-p V _{IN} = Set V _{OUT} +1V I _{OUT} = 30mA, V _{ECO} =V _{IN}		70		dB
V _{IN}	Input Voltage		1.4		6.0	V
ΔV _{OUT} /ΔT	Output Voltage Temperature Coefficient	I _{OUT} = 30mA -40°C ≤ TopT ≤ 85°C		±100		ppm /°C
I _{lim}	Short Current Limit	V _{OUT} = 0V		50		mA
R _{PU}	CE Pull-up Resistance		2.0	5.0	14.0	MΩ
R _{PD}	ECO Pull-down Resistance		1.5	5.0	14.0	MΩ
V _{CEH}	CE, ECO Input Voltage "H"		1.0		V _{IN}	V
V _{CEL}	CE, ECO Input Voltage "L"		0.0		0.3	V

Note1: ±30mV tolerance for V_{OUT} ≤ 1.5V.

Note2: ±45mV tolerance for V_{OUT} ≤ 1.5V.

● R1160NXX1B

Topt=25°C

Symbol	Item	Conditions	MIN.	TYP.	MAX.	Unit
V _{OUT}	Output Voltage	V _{IN} = Set V _{OUT} +1V V _{ECO} =V _{IN} 1μA ≤ I _{OUT} ≤ 30mA(Note 1)	V _{OUT} ×0.98 (-30mV)		V _{OUT} ×1.02 (30mV)	V
		V _{IN} = Set V _{OUT} +1V V _{ECO} =GND 1μA ≤ I _{OUT} ≤ 30mA(Note 2)	V _{OUT} ×0.97 (-45mV)		V _{OUT} ×1.03 (45mV)	V
I _{OUT}	Output Current	V _{IN} - V _{OUT} = 0.5V V _{IN} ≥1.5V, V _{OUT} ≤1.0V	200			mA
ΔV _{OUT} /ΔI _{OUT}	Load Regulation(FT Mode)	V _{IN} = Set V _{OUT} +1V, V _{ECO} =V _{IN} 1mA ≤ I _{OUT} ≤ 200mA		20	40	mV
ΔV _{OUT} /ΔI _{OUT}	Load Regulation(LP Mode)	V _{IN} = Set V _{OUT} +1V, V _{ECO} =GND 1mA ≤ I _{OUT} ≤ 100mA		10	40	mV
V _{DIF}	Dropout Voltage	Refer to the ELECTRICAL CHARACTERISTICS by OUTPUT VOLTAGE				
I _{SS1}	Supply Current(FT Mode)	V _{IN} = Set V _{OUT} +1V V _{ECO} =V _{IN}		40	70	μA
I _{SS2}	Supply Current(LP Mode)	V _{IN} = Set V _{OUT} +1V, V _{OUT} ≤ 1.5V, V _{ECO} =GND		3.5	6.0	μA
		V _{IN} = Set V _{OUT} +1V, V _{OUT} ≥ 1.6V, V _{ECO} =GND		4.5	8.0	μA
I _{standby}	Supply Current (Standby)	V _{IN} = Set V _{OUT} +1V, V _{CE} =GND		0.1	1.0	μA
ΔV _{OUT} /ΔV _{IN}	Line Regulation(FT Mode)	Set V _{OUT} +0.5V ≤ V _{IN} ≤ 6V I _{OUT} = 30mA, V _{ECO} =V _{IN}		0.05	0.20	%/V
ΔV _{OUT} /ΔV _{IN}	Line Regulation(LP Mode)	Set V _{OUT} +0.5V ≤ V _{IN} ≤ 6V I _{OUT} = 30mA, V _{ECO} =GND		0.10	0.30	%/V
RR	Ripple Rejection(FT Mode)	f = 1kHz, Ripple 0.2Vp-p V _{IN} = Set V _{OUT} +1V I _{OUT} = 30mA, V _{ECO} =V _{IN}		70		dB
V _{IN}	Input Voltage		1.4		6.0	V
ΔV _{OUT} /ΔT	Output Voltage Temperature Coefficient	I _{OUT} = 30mA -40°C ≤ Topt ≤ 85°C		±100		ppm /°C
I _{lim}	Short Current Limit	V _{OUT} = 0V		50		mA
R _{PDC}	CE Pull-down Resistance		2.0	5.0	14.0	MΩ
R _{PDE}	ECO Pull-down Resistance		1.5	5.0	14.0	MΩ
V _{CEH}	CE, ECO Input Voltage "H"		1.0		V _{IN}	V
V _{CEL}	CE, ECO Input Voltage "L"		0.0		0.3	V

Note1: ±30mV tolerance for V_{OUT}≤1.5V.

Note2: ±45mV tolerance for V_{OUT}≤1.5V.

● ELECTRICAL CHARACTERISTICS by OUTPUT VOLTAGE

Topt = 25°C

Output Voltage V _{OUT} (V)	Dropout Voltage		
	V _{DIF} (V)		
	Condition	TYP.	MAX.
0.8 ≤ V _{OUT} ≤ 0.9	I _{OUT} = 200mA	0.40	0.70
1.0 ≤ V _{OUT} ≤ 1.4		0.30	0.50
1.5 ≤ V _{OUT} ≤ 2.5		0.20	0.30
2.6 ≤ V _{OUT}		0.14	0.20 (V _{ECO} ="H") 0.25(V _{ECO} ="L")

TECHNICAL NOTES

When using these ICs, consider the following points:

Phase Compensation

In these ICs, phase compensation is made for securing stable operation even if the load current is varied. For this purpose, be sure to use a 2.2 μ F or more capacitor C_{OUT} with good frequency characteristics and ESR (Equivalent Series Resistance). (Note: When the additional ceramic capacitors are connected to the Output Pin with Output capacitor for phase compensation, the operation might be unstable. Because of this, test these ICs with as same external components as ones to be used on the PCB.)

PCB Layout

Make VDD and GND line sufficient. When the impedance of these is high, it would be a cause of picking up the noise or unstable operation. Connect a capacitor with as much as 1.0 μ F capacitor between VDD and GND pin as close as possible. Set external components, especially output capacitor as close as possible to the ICs and make wiring shortest.

TEST CIRCUITS

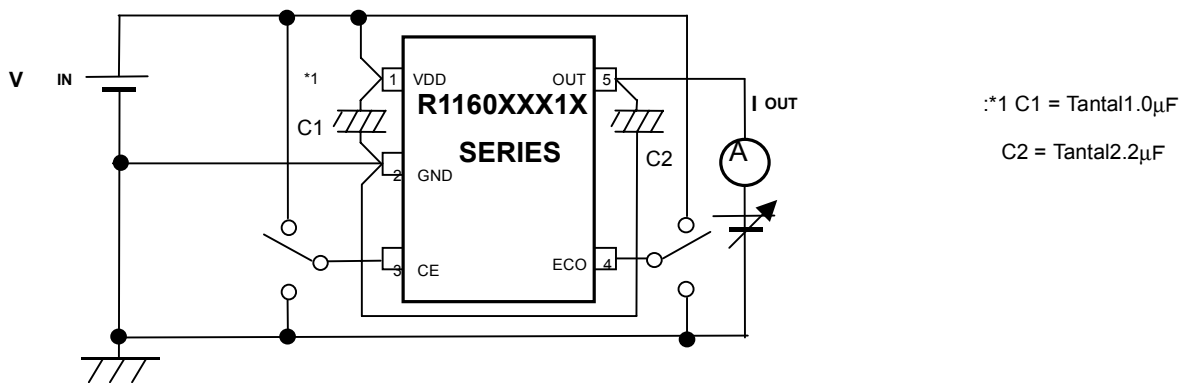

Fig.1 Output Voltage vs. Output Current Test Circuit

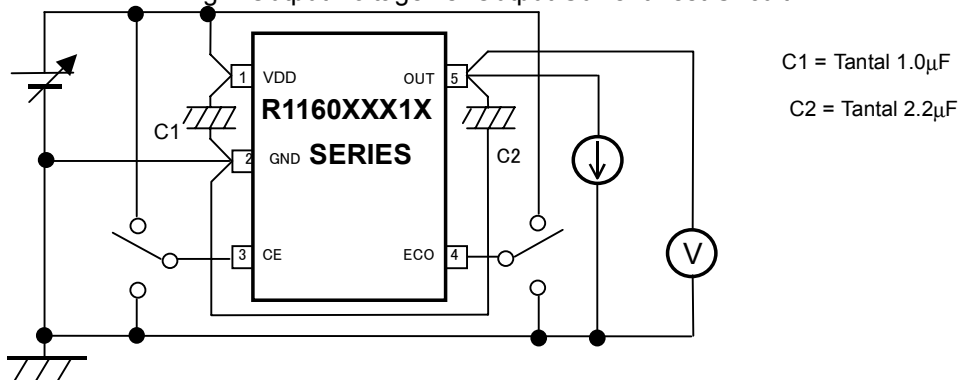

Fig.2 Output Voltage vs. Input Voltage Test Circuit

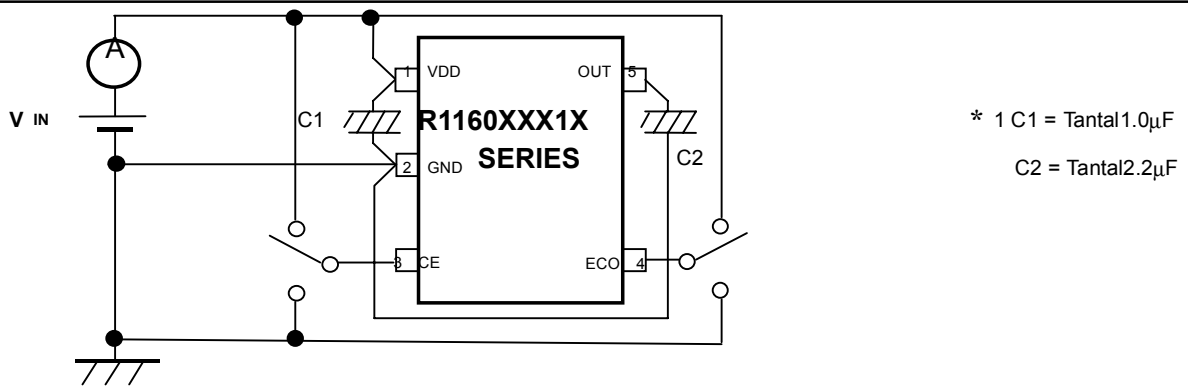

Fig.3 Supply Current vs. Input Voltage Test Circuit

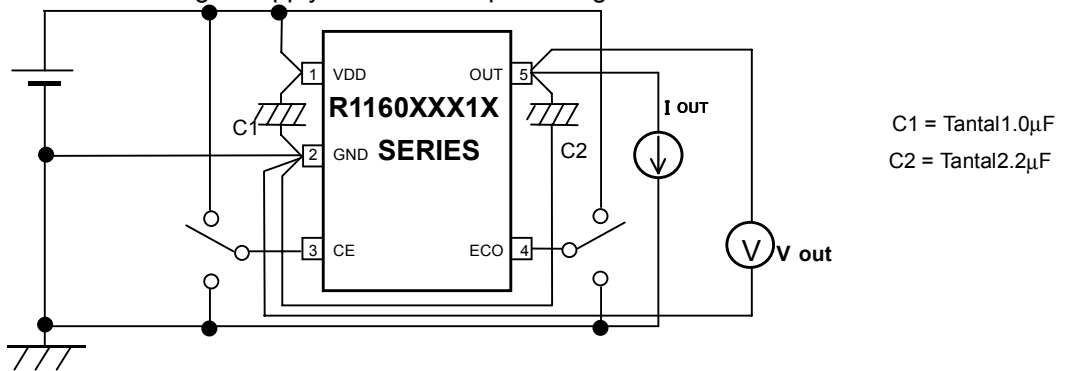

Fig.4 Output Voltage vs. Temperature Test Circuit

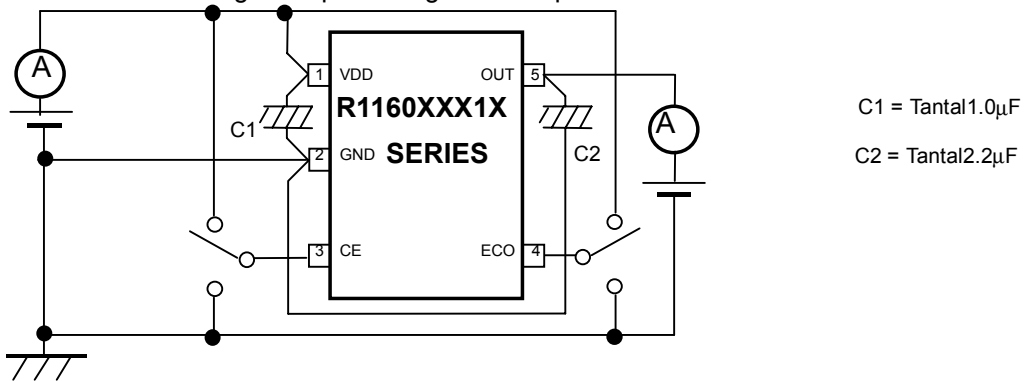

Fig.5 Supply Current vs. Temperature Test Circuit

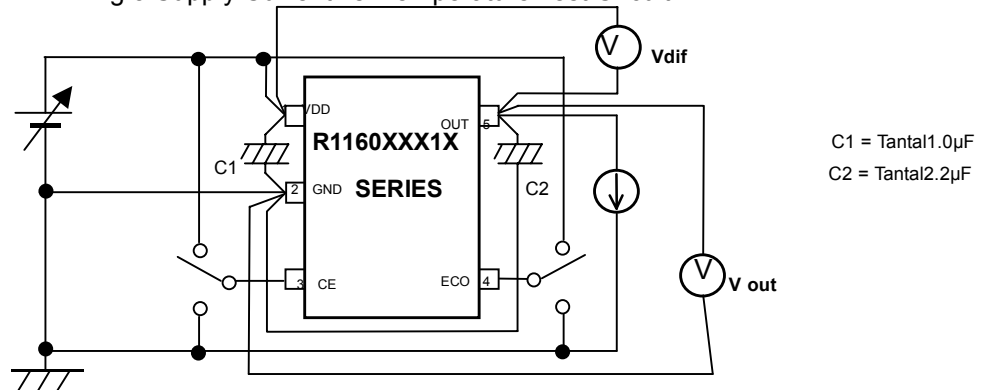

Fig. 6 Dropout Voltage vs. Output Current/ Set Output Voltage Test Circuit

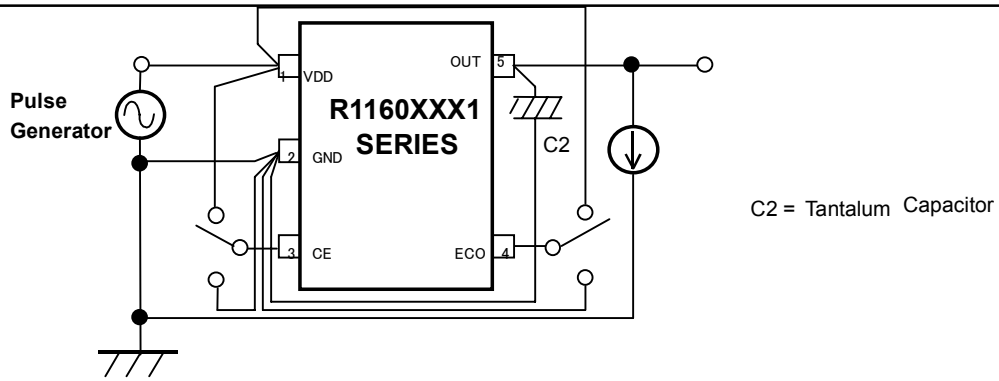

Fig. 7 Ripple Rejection Test Circuit

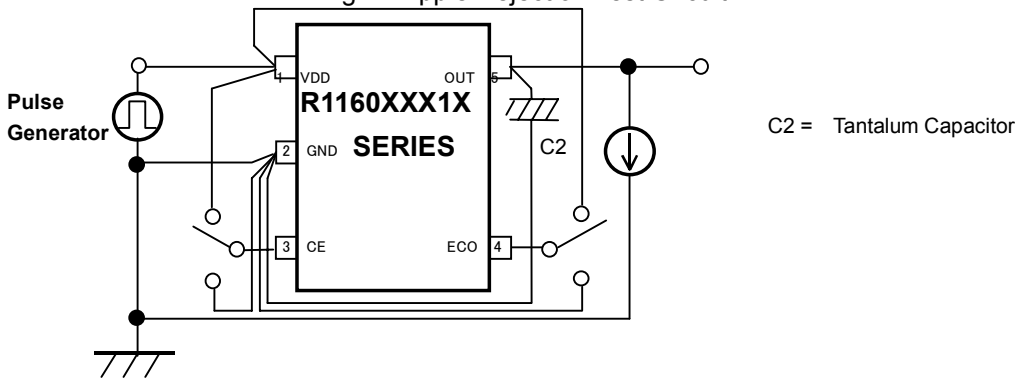

Fig.8 Input Transient Response Test Circuit

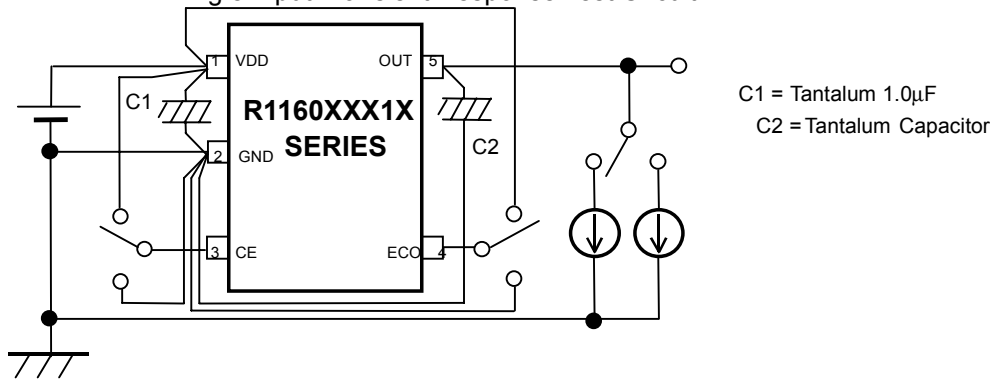

Fig.9 Load Transient Response Test Circuit

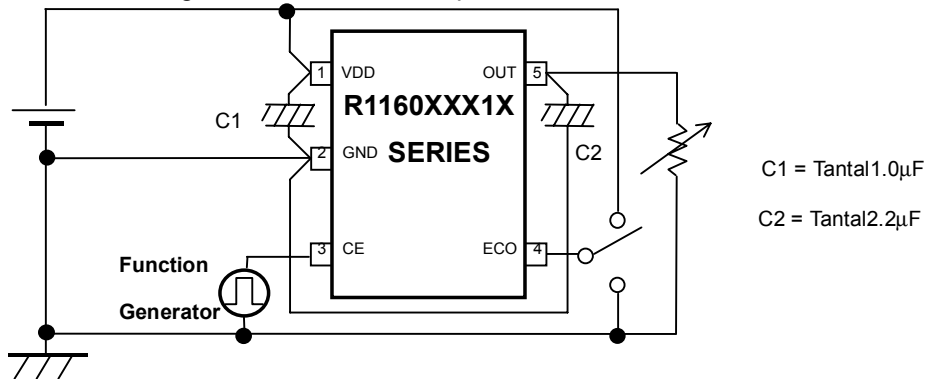

Fig.10 Turn on Speed with CE pin Test Circuit

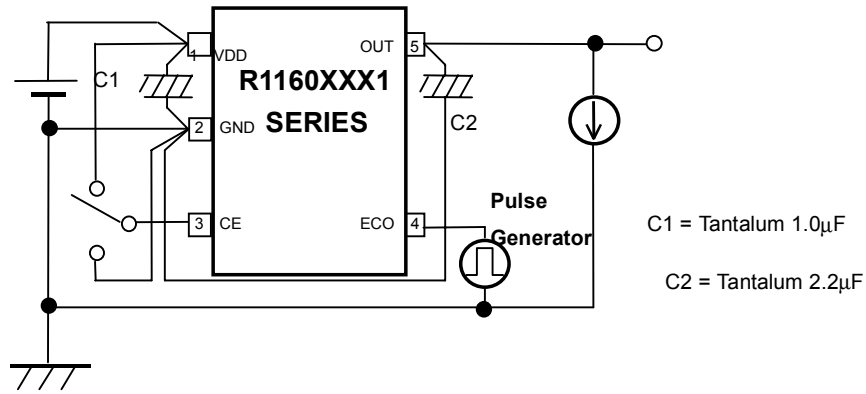

Fig.11 MODE Transient Response Test Circuit

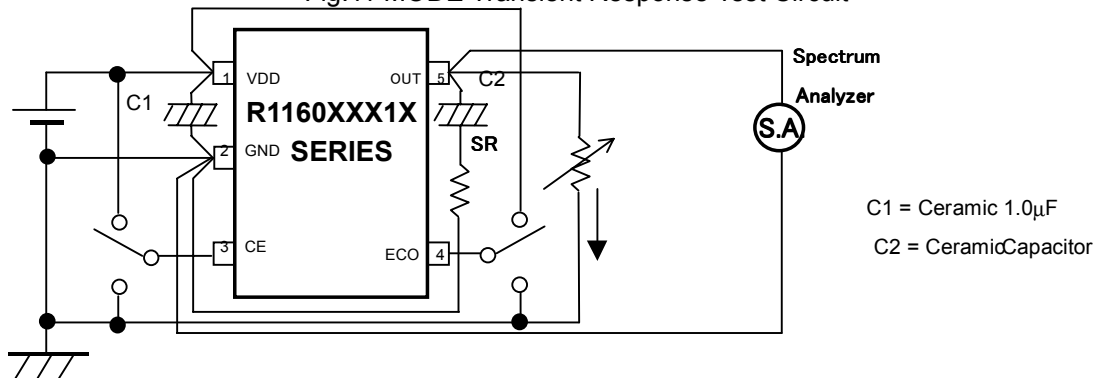
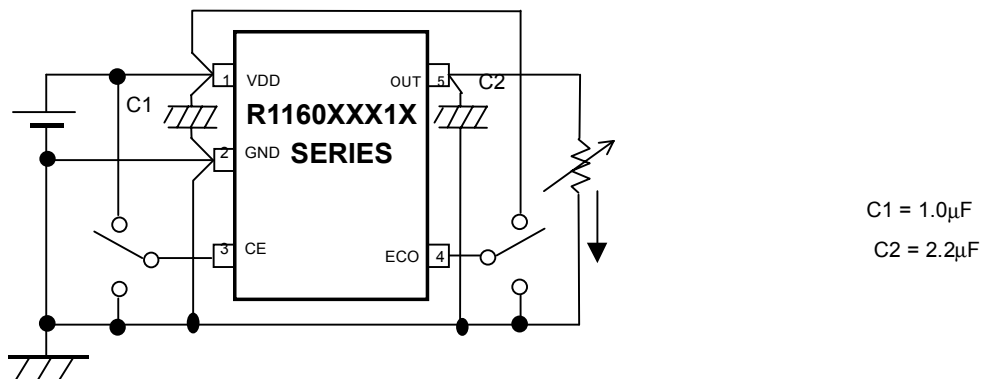

Fig.12 Output Noise Test Circuit(I_{OUT} vs. ESR)

■ TYPICAL APPLICATION



(External Components)
Output Capacitor; Tantalum Type

TYPICAL CHARACTERISTICS

1) Output Voltage vs. Output Current

R1160N081X ECO=H

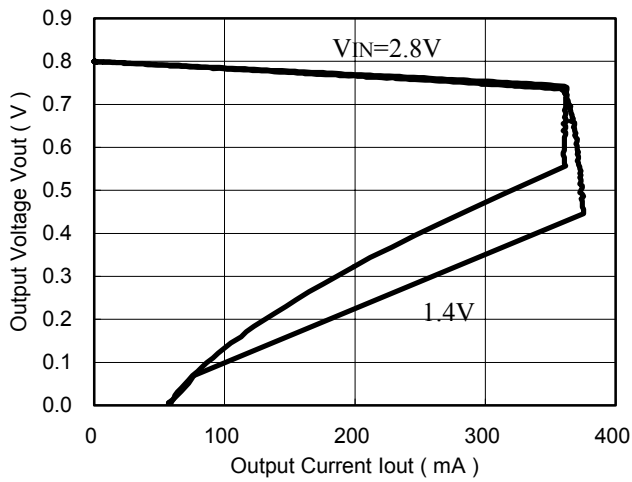

R1160N081X ECO=L

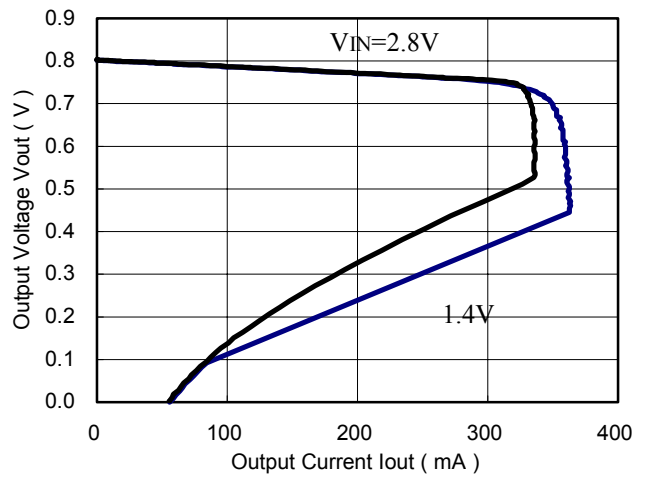

R1160N151X ECO=H

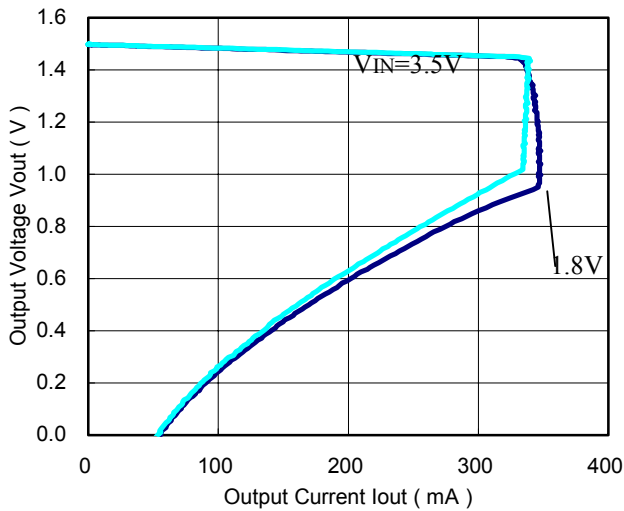

R1160N151X ECO=L

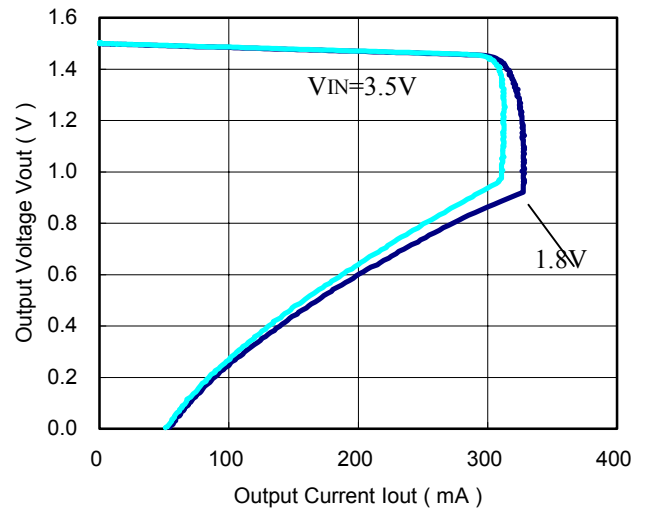

R1160N261X ECO=H

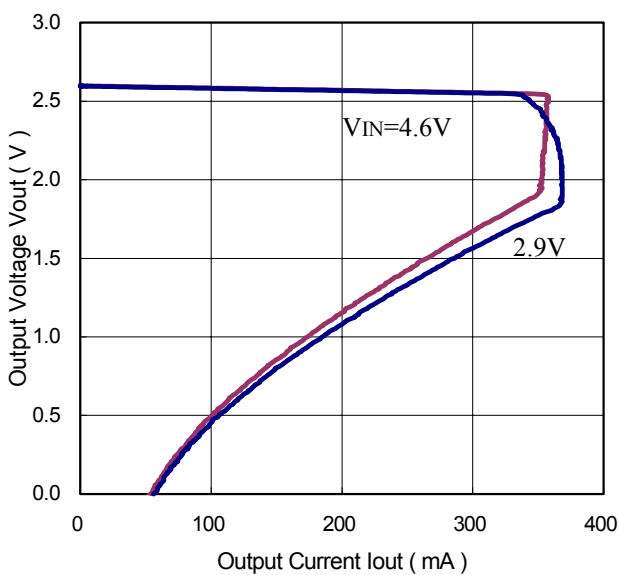

R1160N261X ECO=L

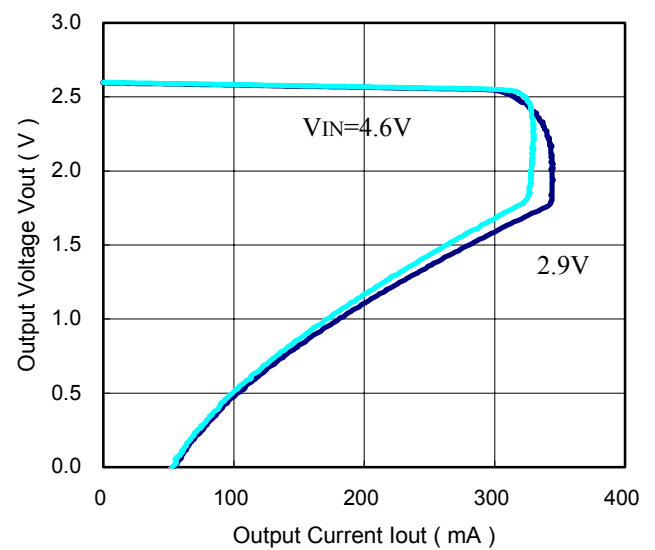

R1160N331X ECO=H

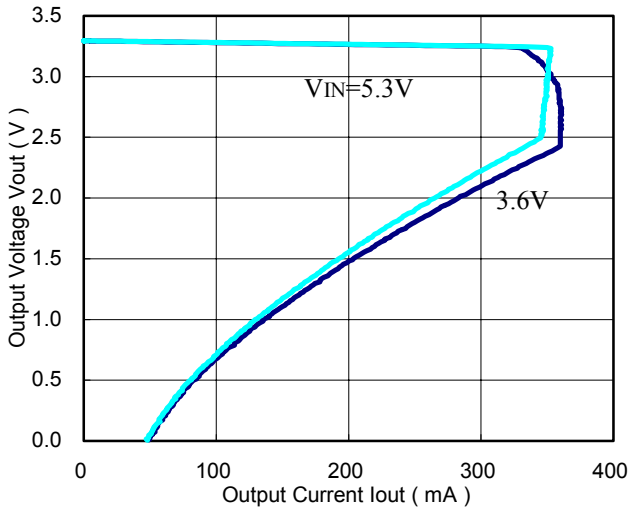

R1160N331X ECO=L

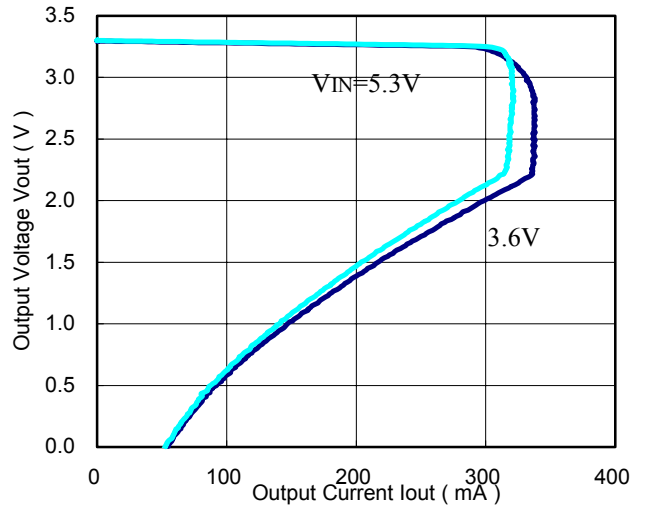

2) Output Voltage vs. Input Voltage

R1160N081X ECO=H

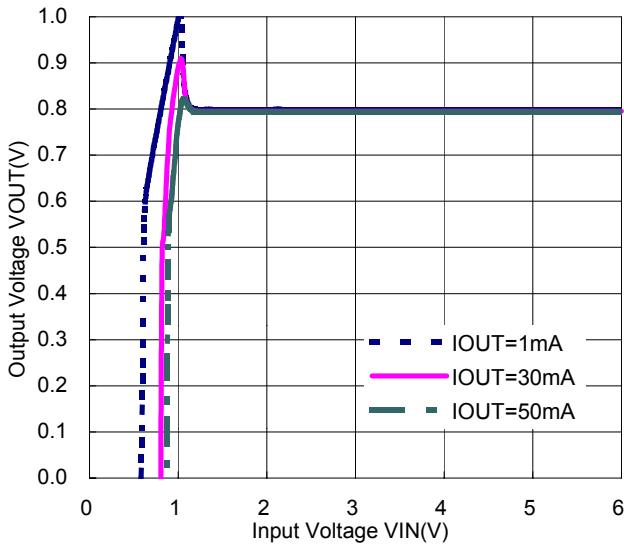

R1160N081X ECO=L

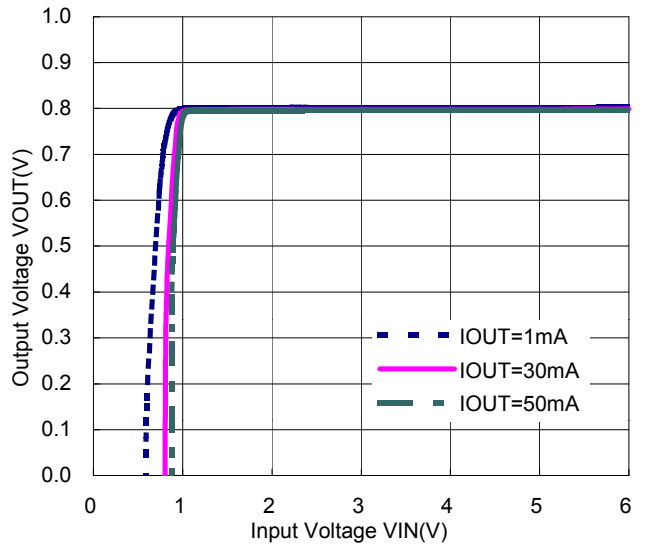

R1160N151X ECO=H

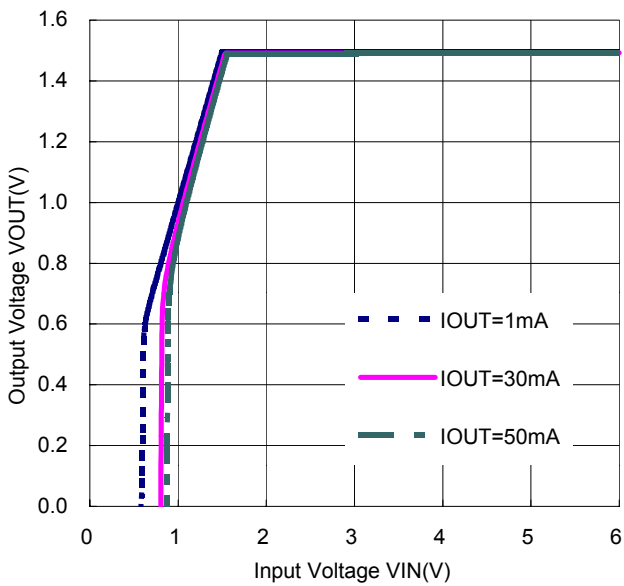

R1160N151X ECO=L

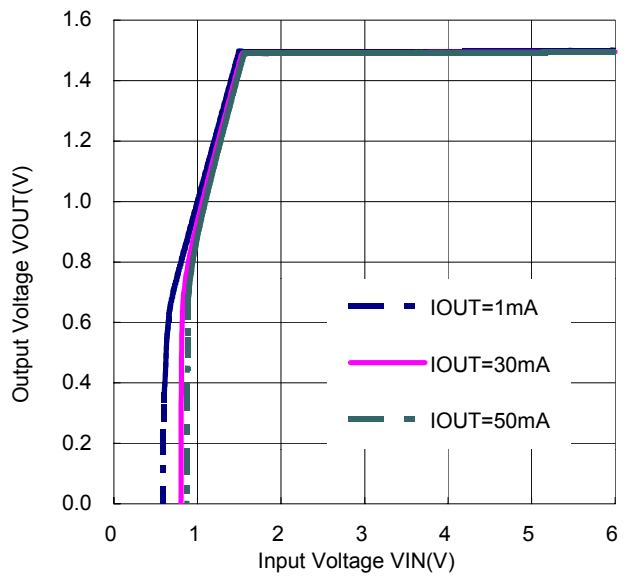

R1160N261X ECO=H

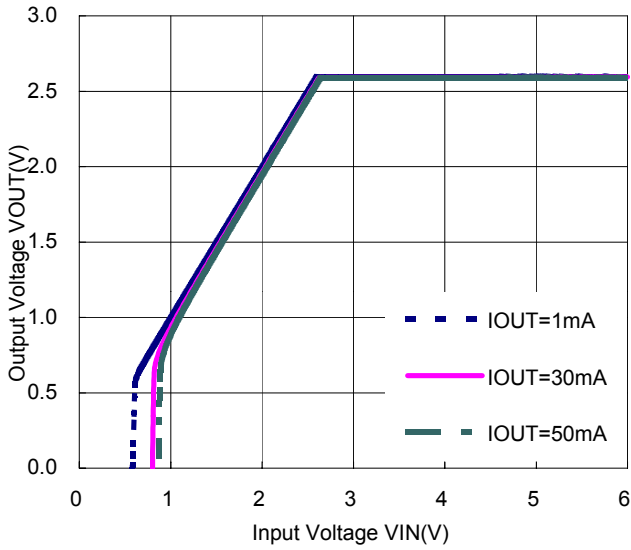

R1160N261X ECO=L

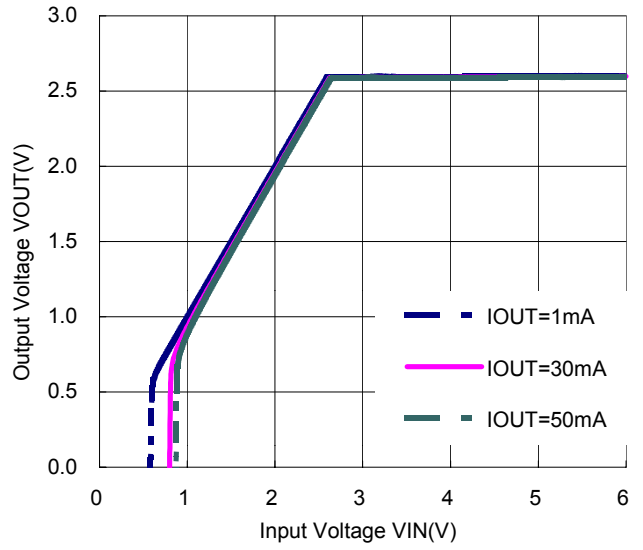

R1160N331X ECO=H

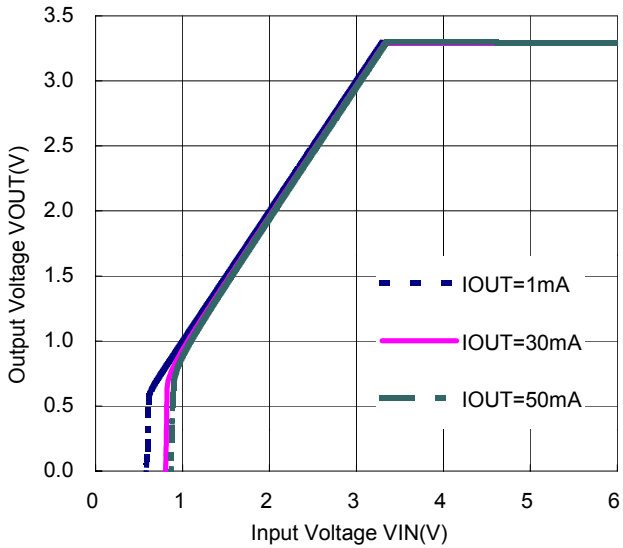

R1160N331X ECO=L

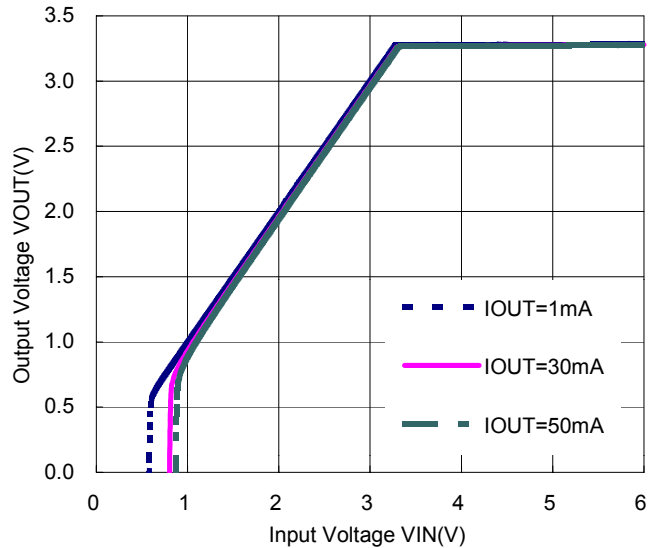

3) Supply Current vs. Input Voltage

R1160N081X ECO=H

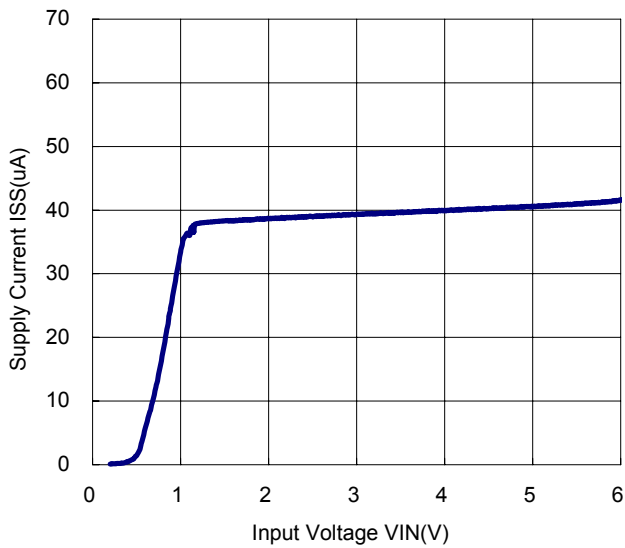

R1160N081X ECO=L

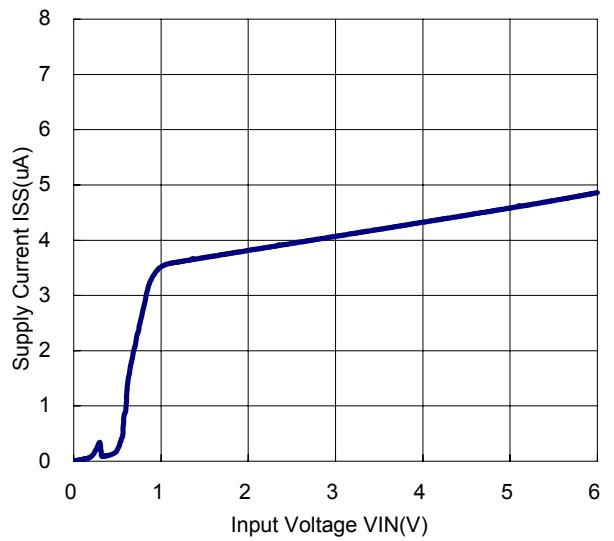

R1160N151X ECO=H

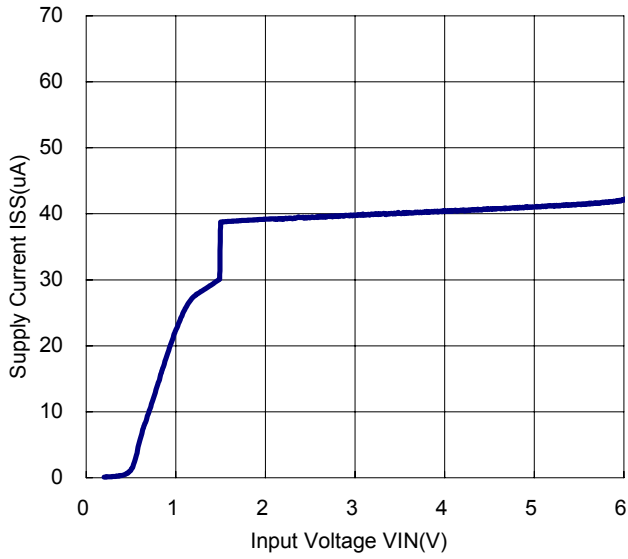

R1160N151X ECO=L

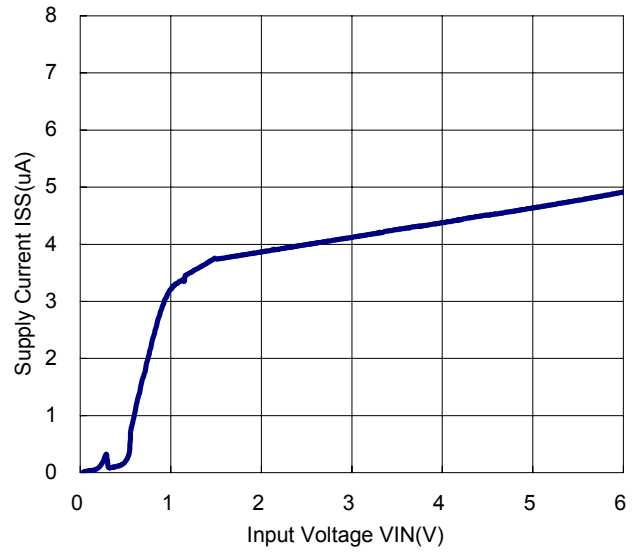

R1160N261X ECO=H

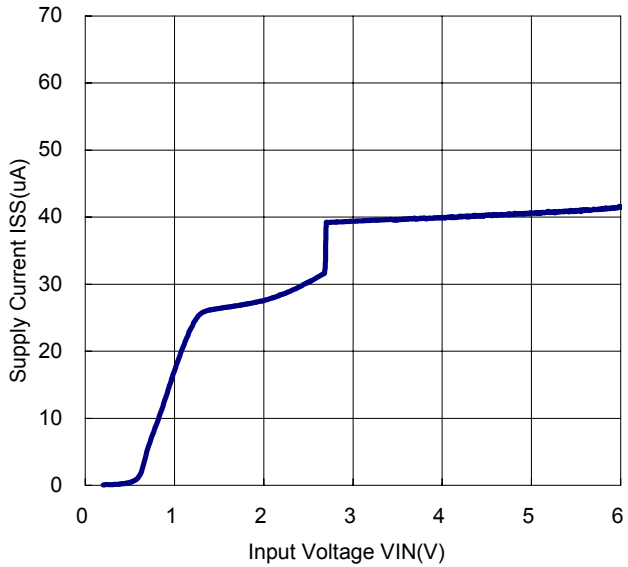

R1160N261X ECO=L

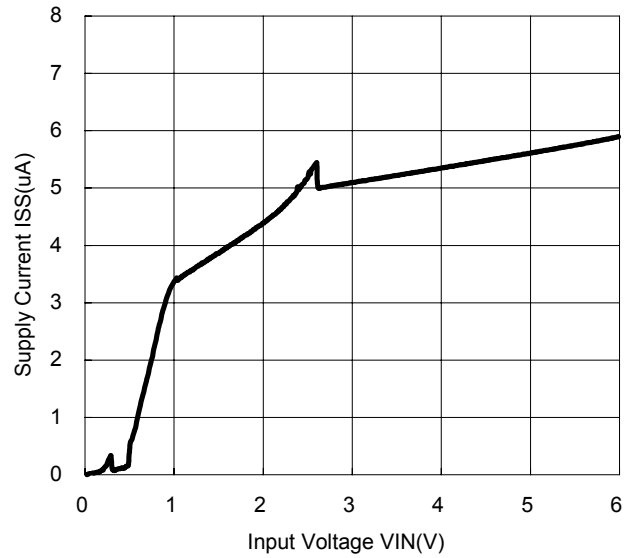

R1160N331X ECO=H

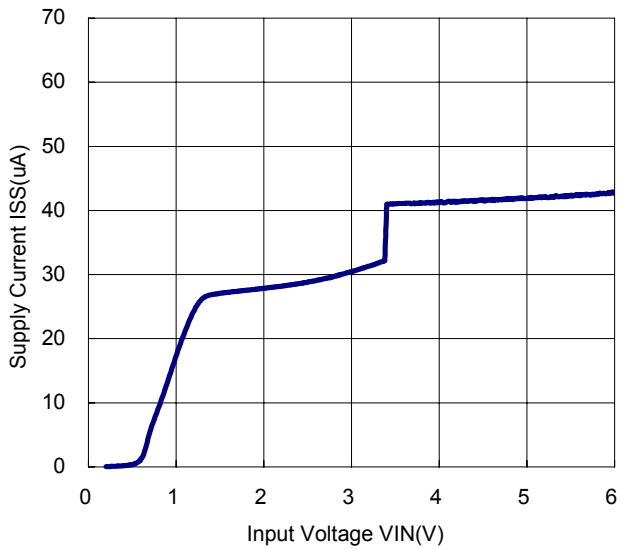

R1160N331X ECO=L

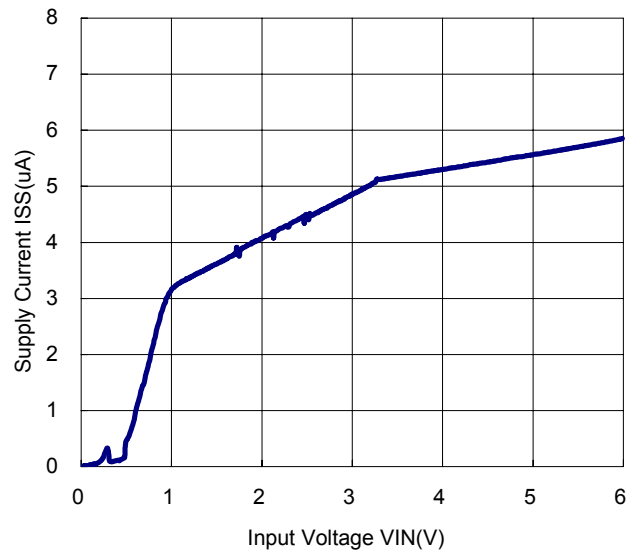

4) Output Voltage vs. Temperature

R1160N081X ECO=H

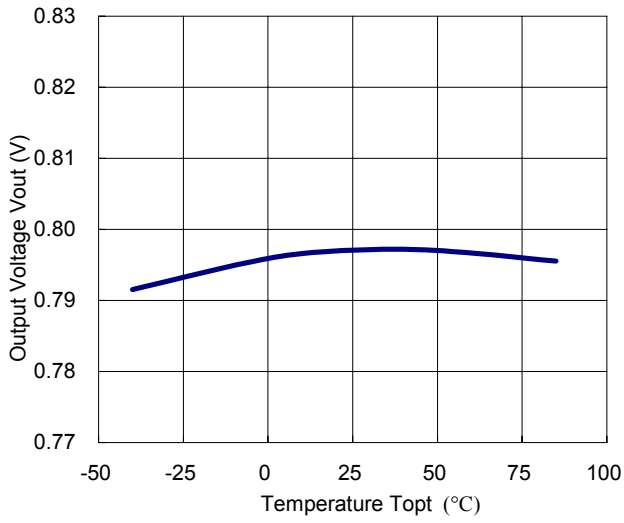

R1160N081X ECO=L

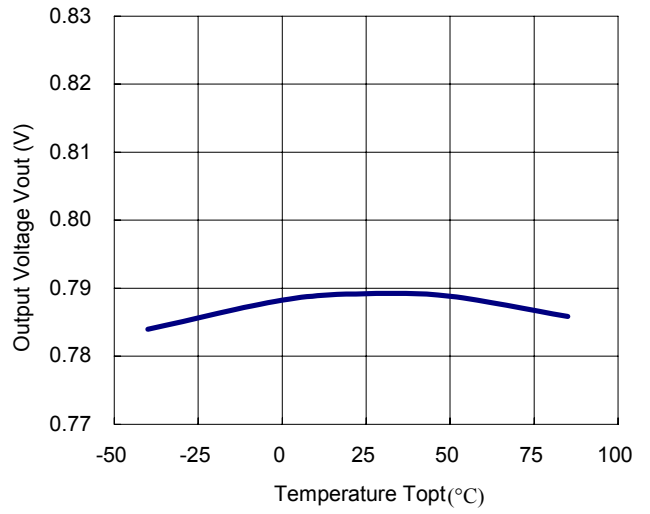

R1160N151X ECO=H

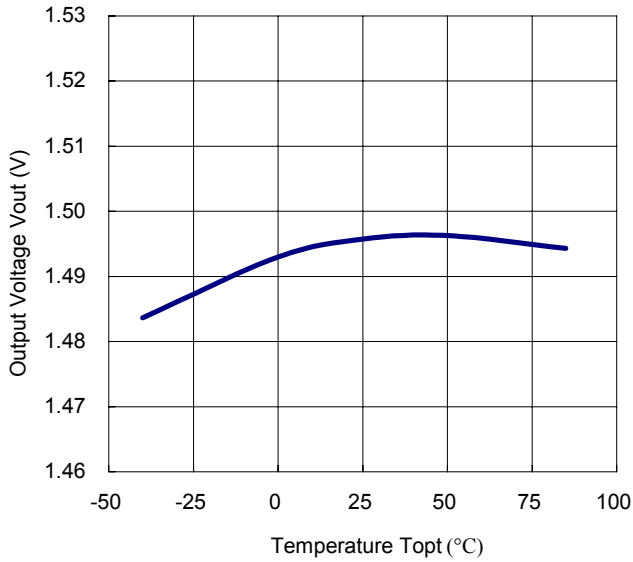

R1160N151X ECO=L

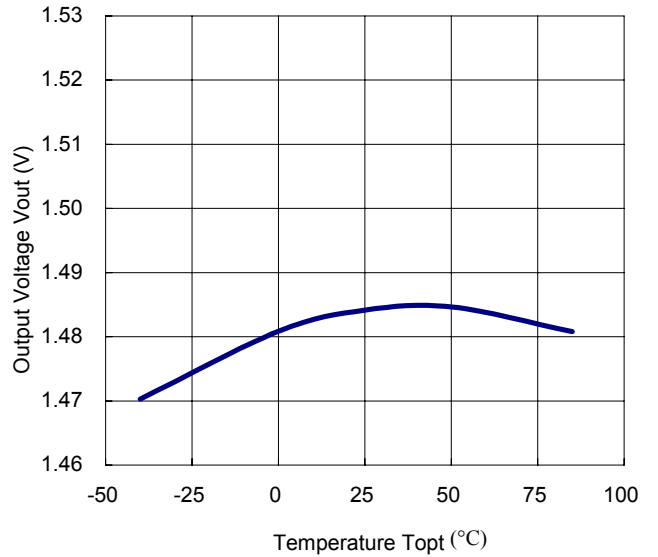

R1160N261X ECO=H

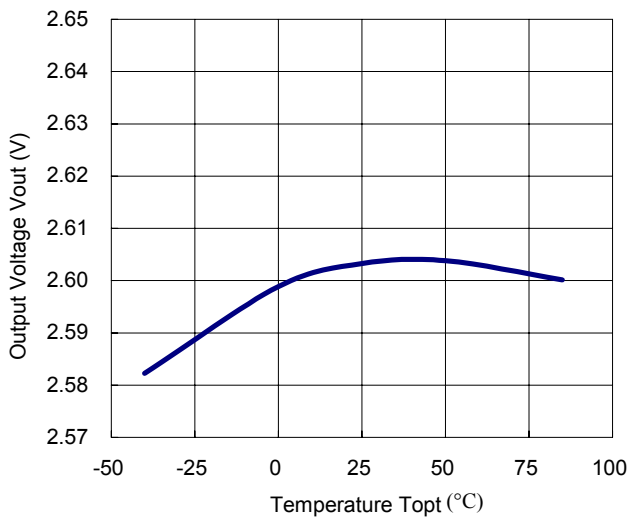

R1160N261X ECO=L

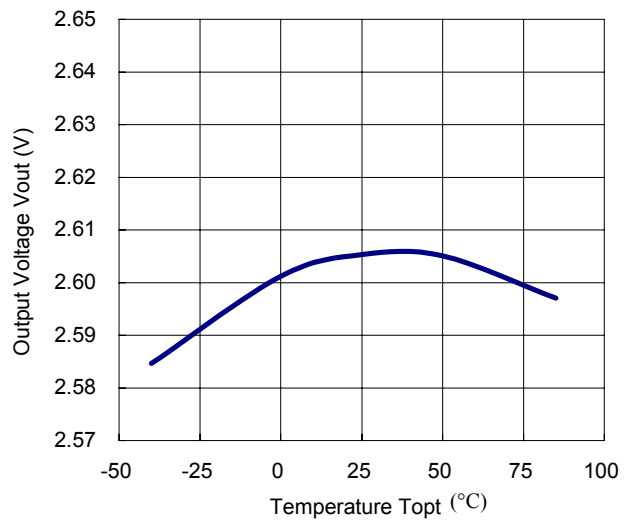

R1160N331X ECO=H

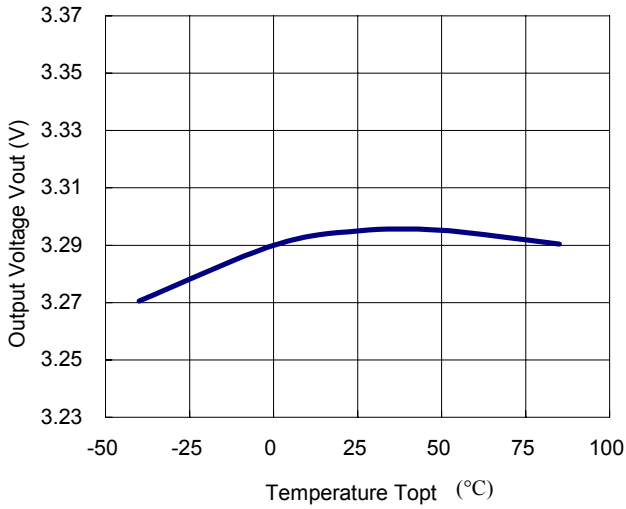

R1160N331X ECO=L

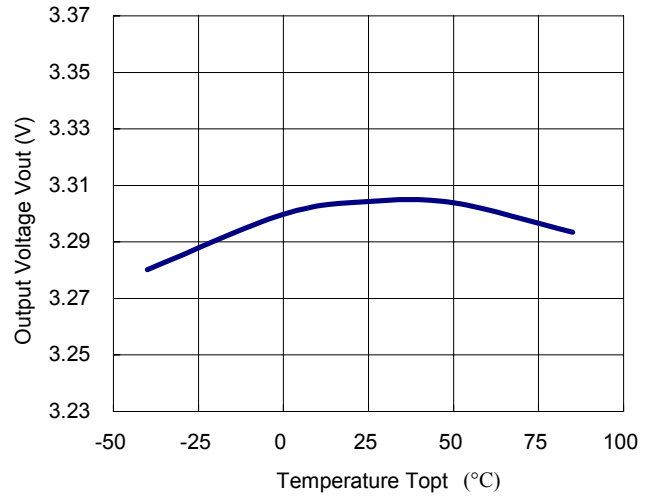

5) Supply Current vs. Temperature

R1160N081X ECO=H

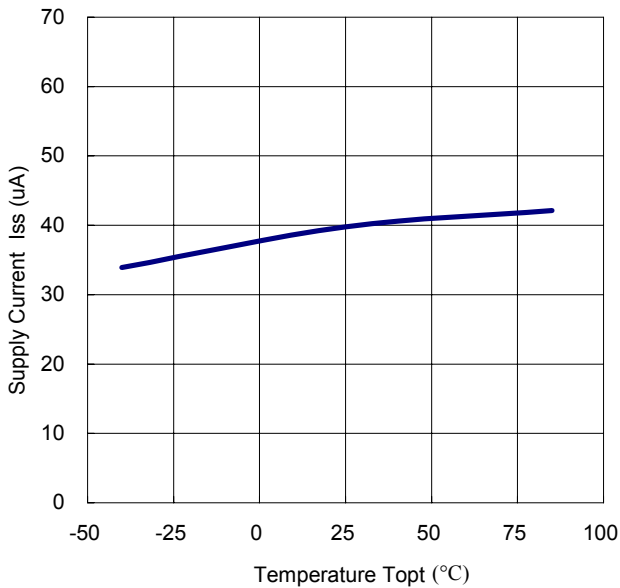

R1160N081X ECO=L

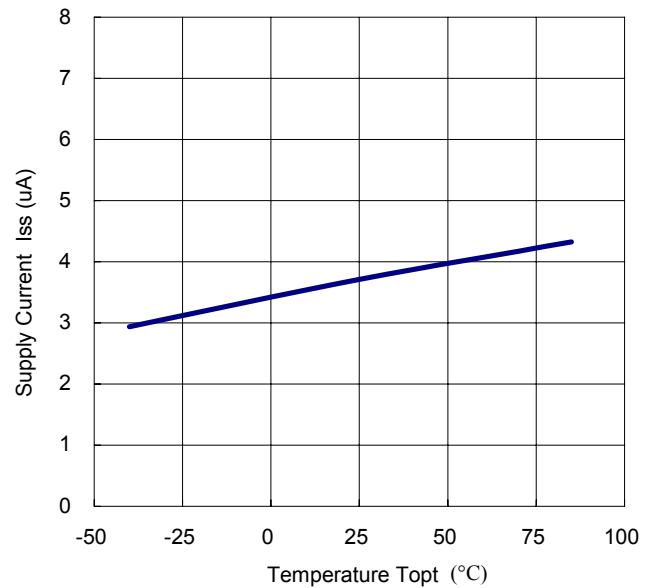

R1160N151X ECO=H

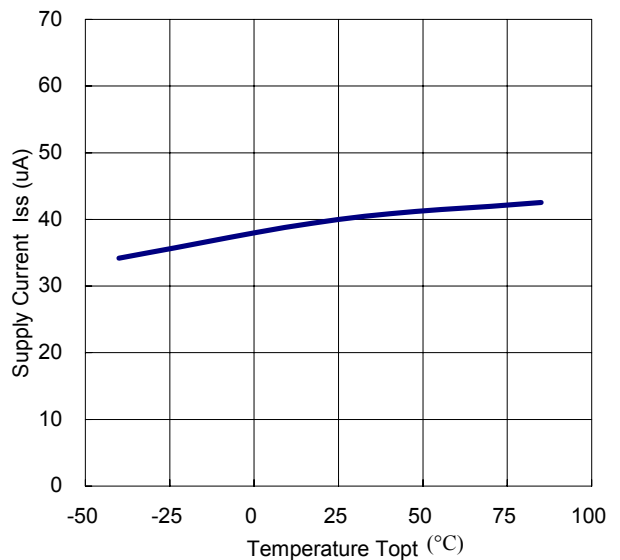

R1160N151X ECO=L

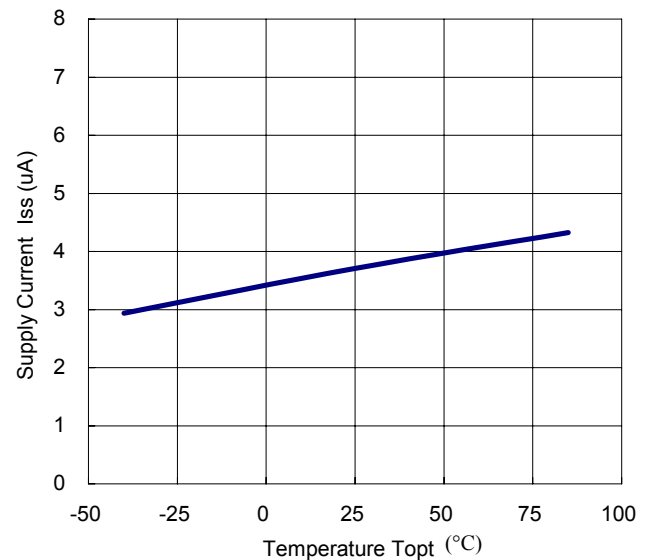

R1160N261X ECO=H

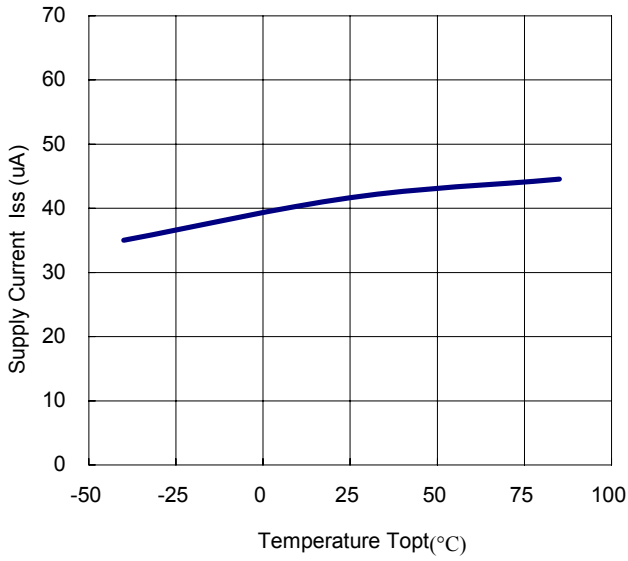

R1160N261X ECO=L

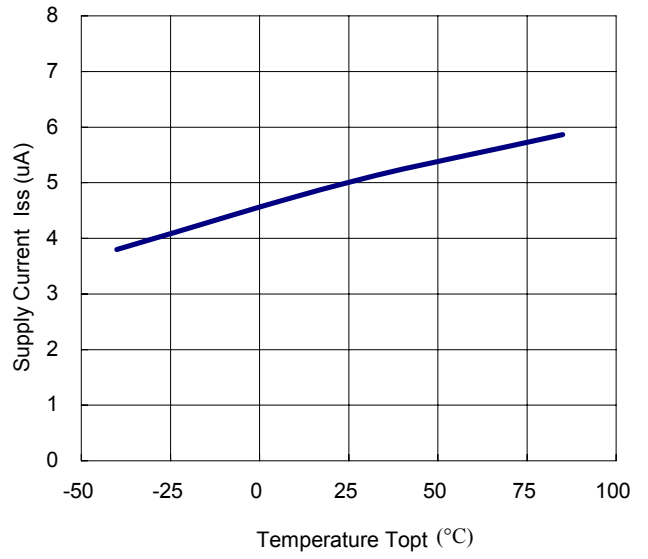

R1160N331X ECO=H

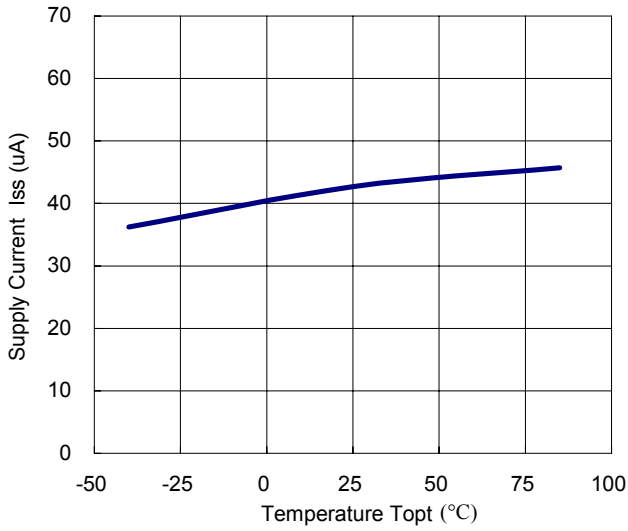

R1160N331X ECO=L

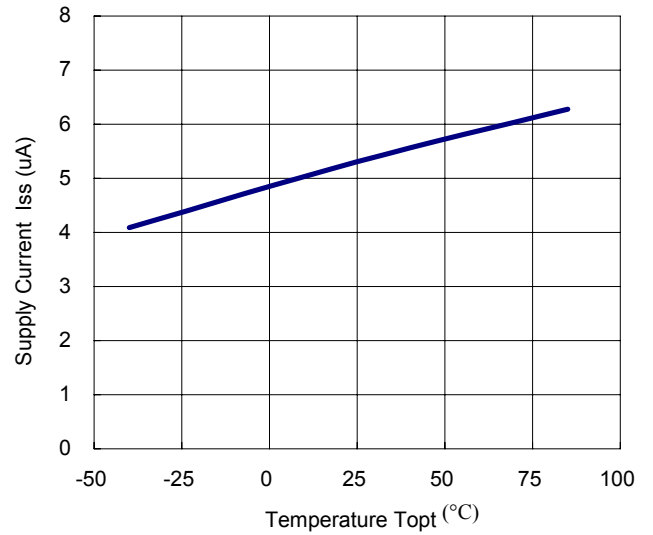

6) Dropout Voltage vs. Output Current

R1160N081X ECO=H

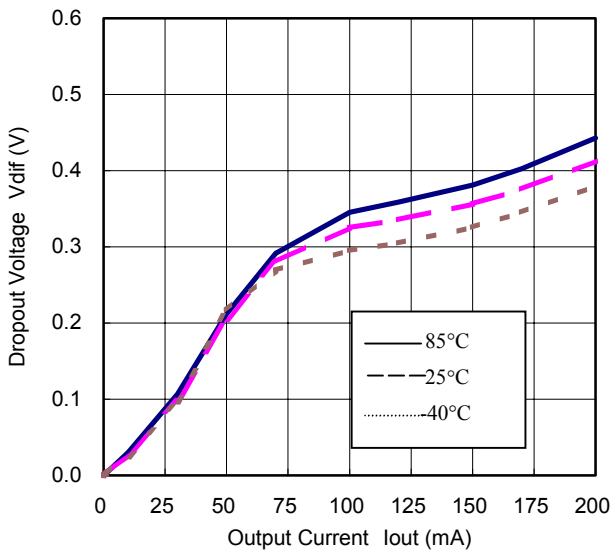

R1160N081X ECO=L

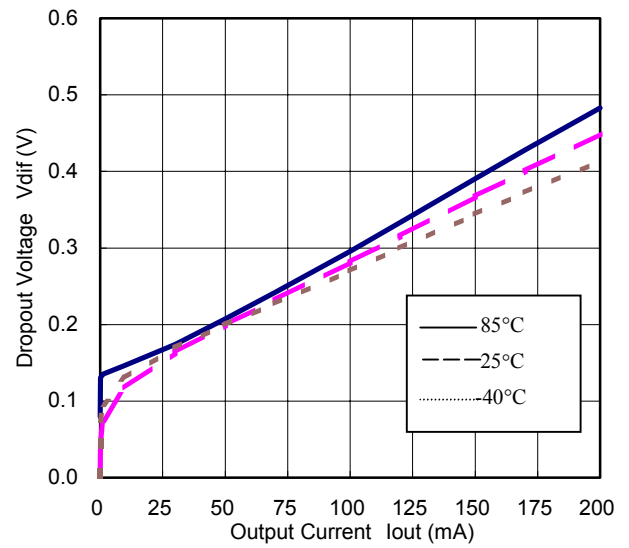

R1160N101X ECO=H

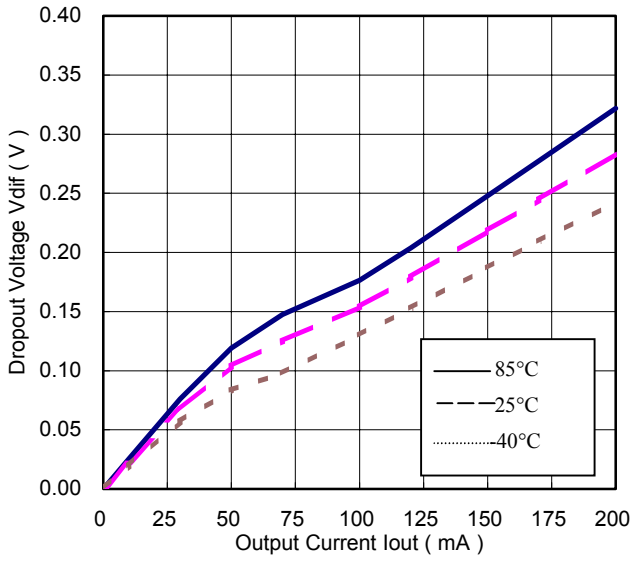

R1160N101X ECO=L

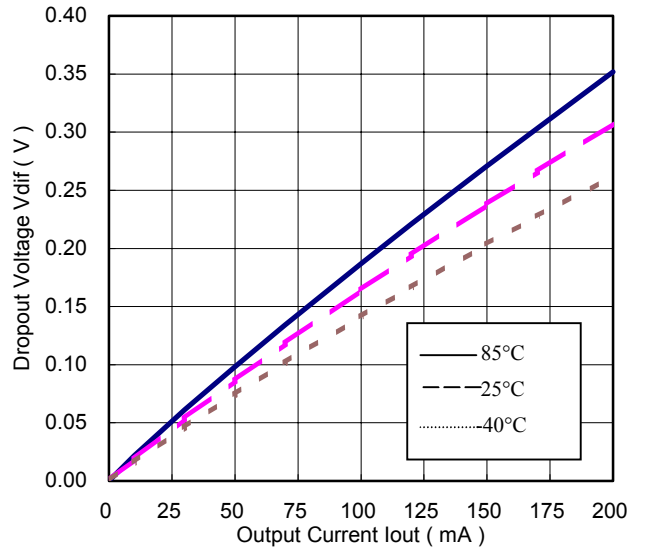

R1160N151X ECO=H

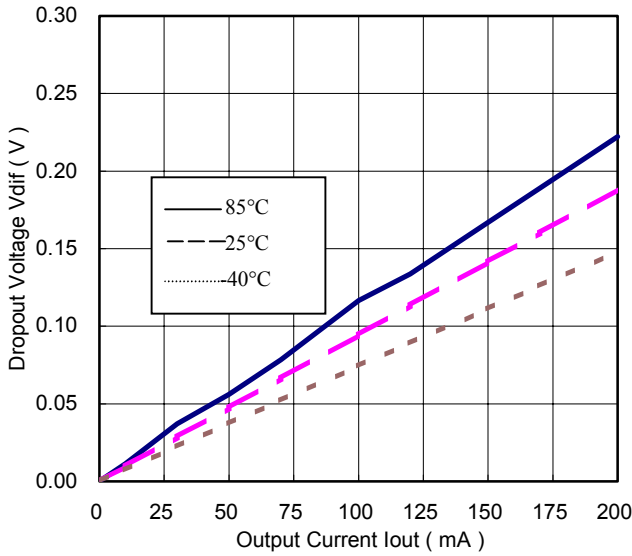

R1160N151X ECO=L

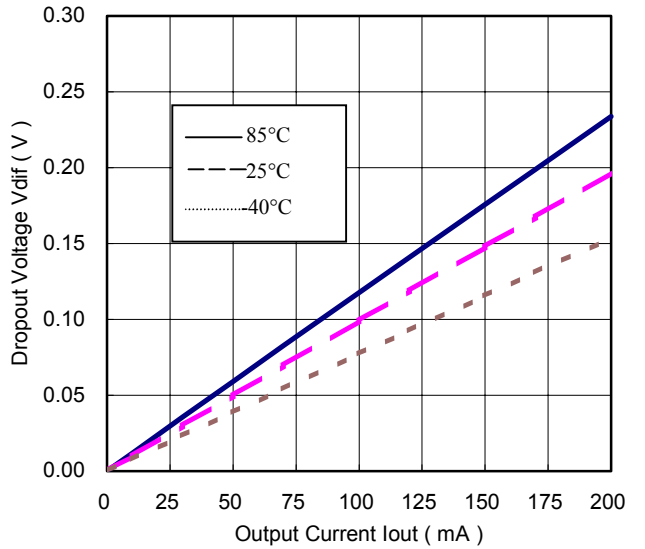

R1160N261X ECO=H

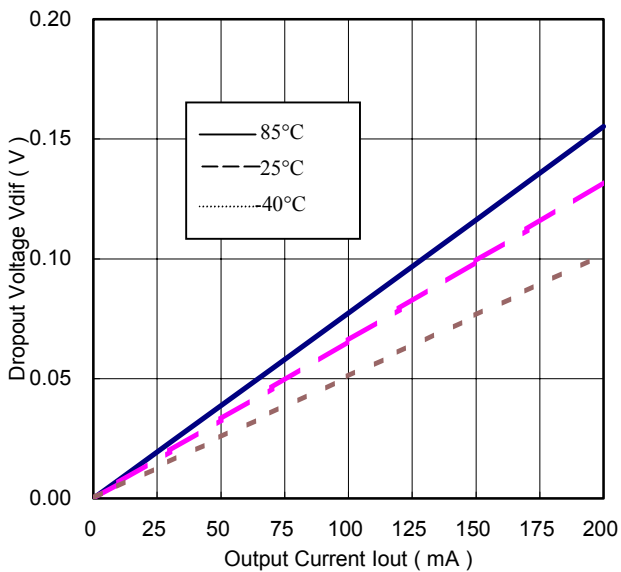

R1160N261X ECO=L

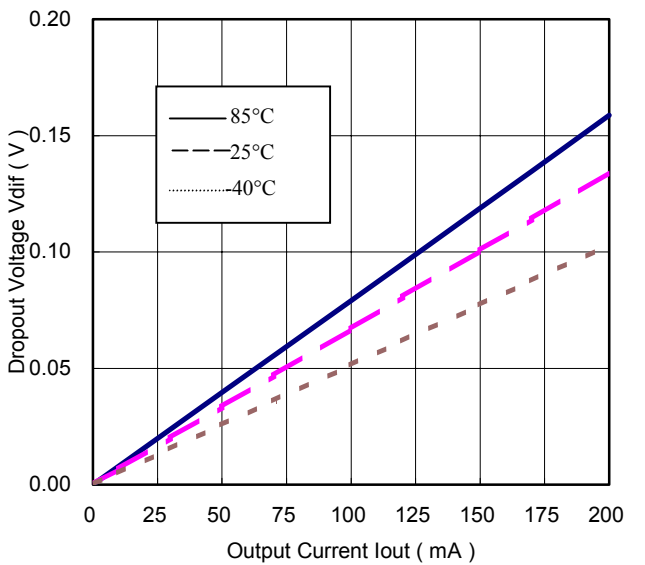

R1160N331X ECO=H

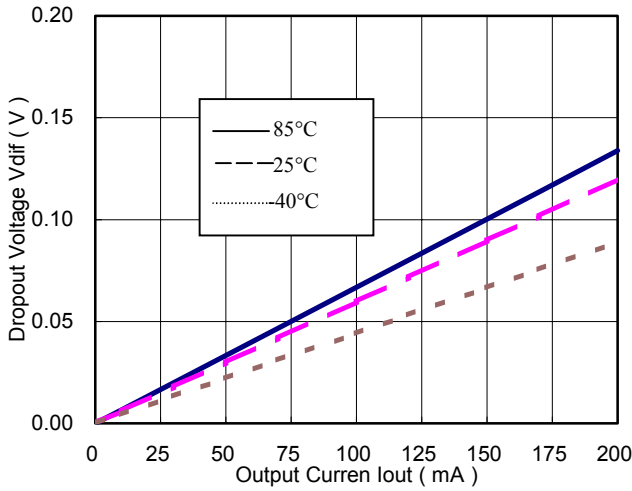

R1160N331X ECO=L

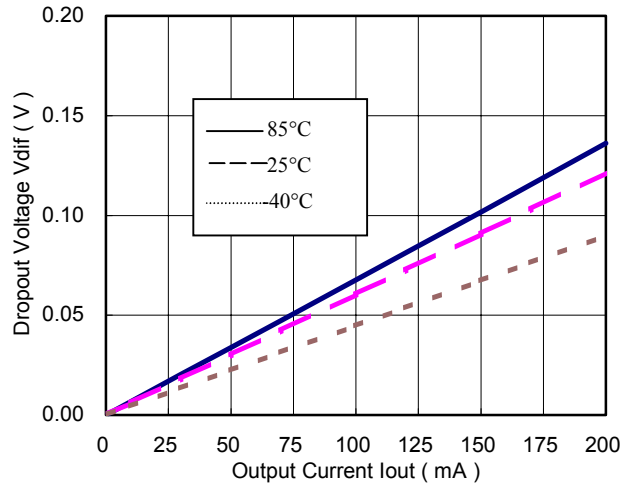

7) Dropout Voltage vs. Set Output Voltage ($T_{opt}=25^{\circ}\text{C}$)

R1160NXX1X ECO=H

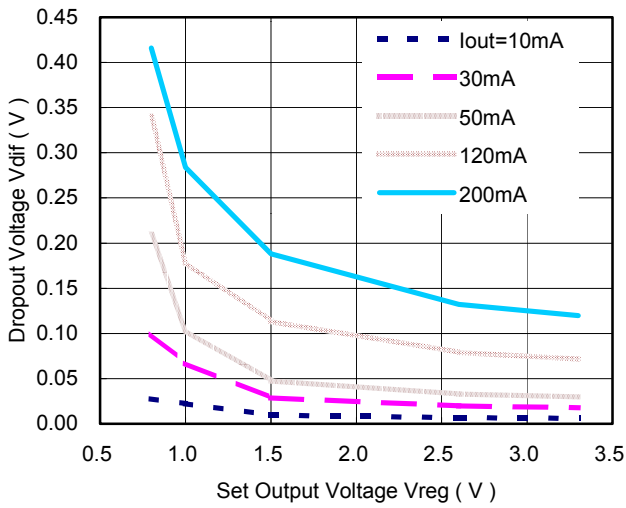

R1160NXX1X ECO=L

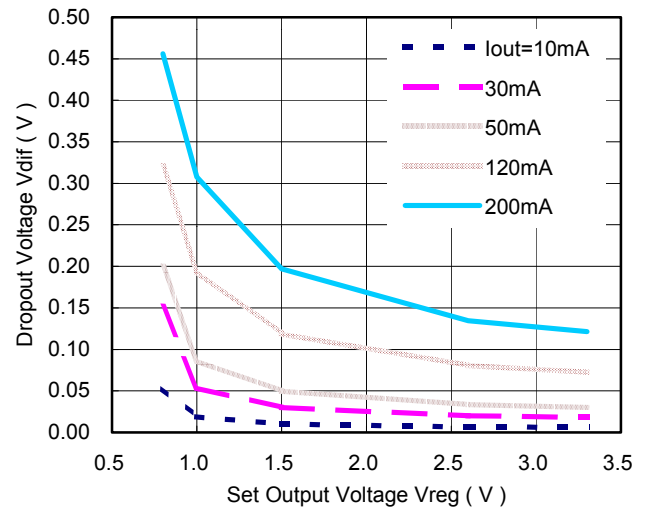

8) Ripple Rejection vs. Input Bias ($T_{opt}=25^{\circ}\text{C}$)

R1160N261X Ripple 0.2Vp-p
 $I_{out}=1\text{mA}$ C_{in} ; none $C_{out}=\text{Tantal}2.2\mu\text{F}$

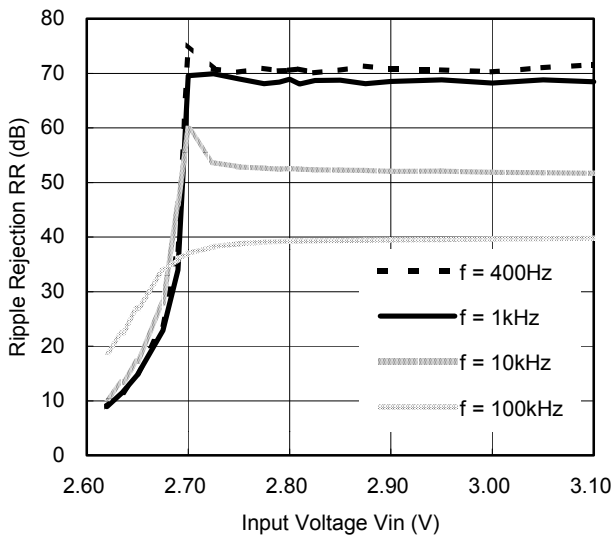

R1160N261X Ripple 0.5Vp-p
 $I_{out}=1\text{mA}$ C_{in} ; none $C_{out}=\text{Tantal}2.2\mu\text{F}$

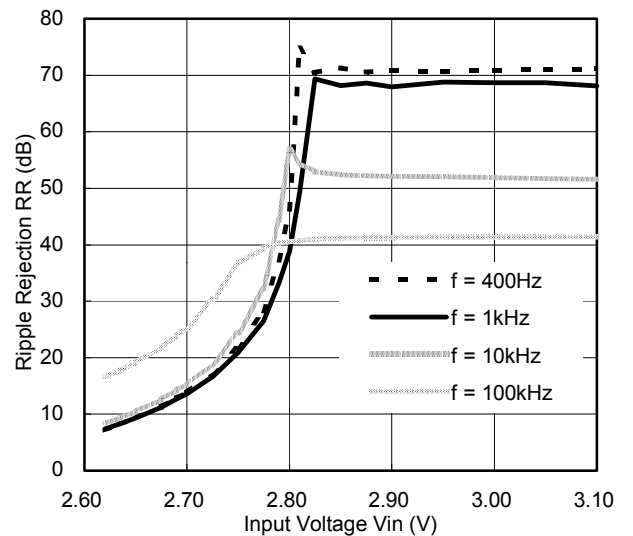

R1160N261X Ripple 0.2Vp-p
 $I_{out}=30mA$ C_{IN}; none C_{OUT}=Tantal2.2 μ F

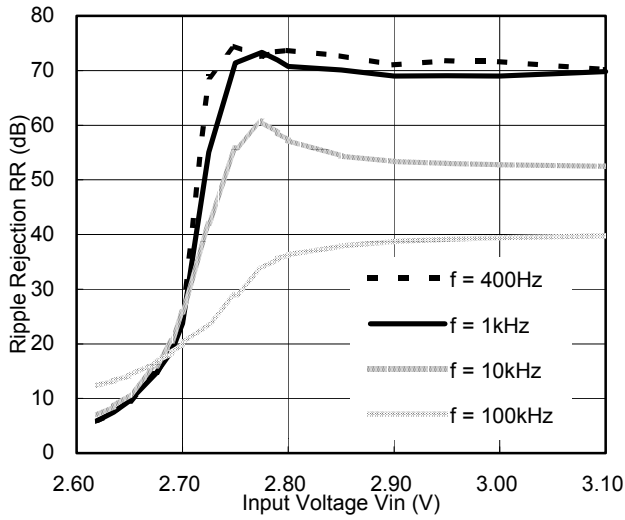

R1160N261X Ripple 0.5Vp-p
 $I_{out}=30mA$ C_{IN}; none C_{OUT}=Tantal2.2 μ F

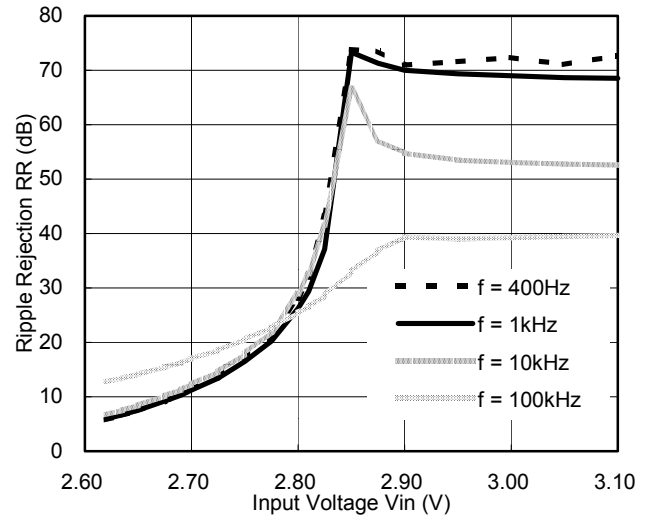

R1160N261X Ripple 0.2Vp-p
 $I_{out}=50mA$ C_{IN}; none C_{OUT}=Tantal2.2 μ F

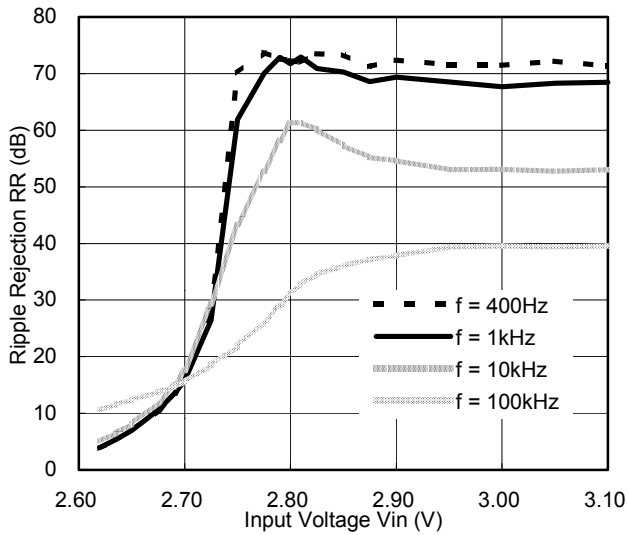

R1160N261X Ripple 0.5Vp-p
 $I_{out}=50mA$ C_{IN}; none C_{OUT}=Tantal2.2 μ F

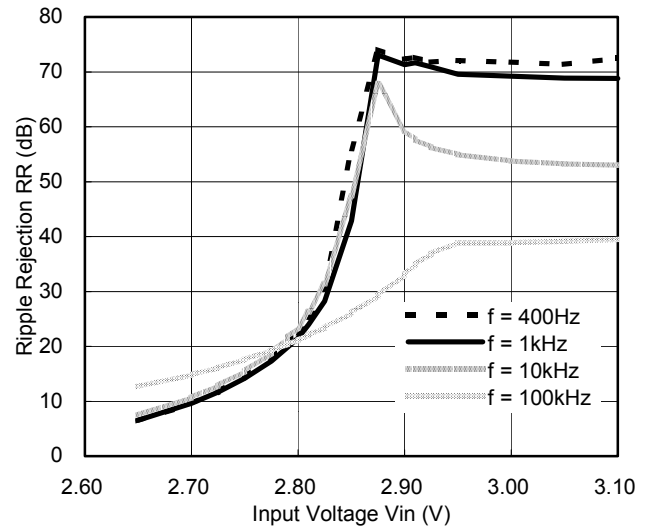

9) Ripple Rejection vs. Frequency

R1160N081X ECO=H

$V_{IN}=1.8V_{DC}+0.2V_{p-p}$, C_{IN}; none, C_{OUT}=tantal2.2 μ F

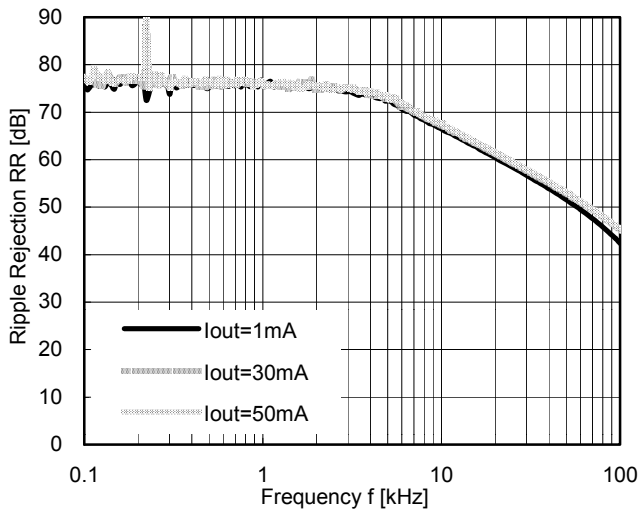

R1160N081X ECO=L

$V_{IN}=1.8V_{DC}+0.2V_{p-p}$, C_{IN}; none, C_{OUT}=tantal2.2 μ F

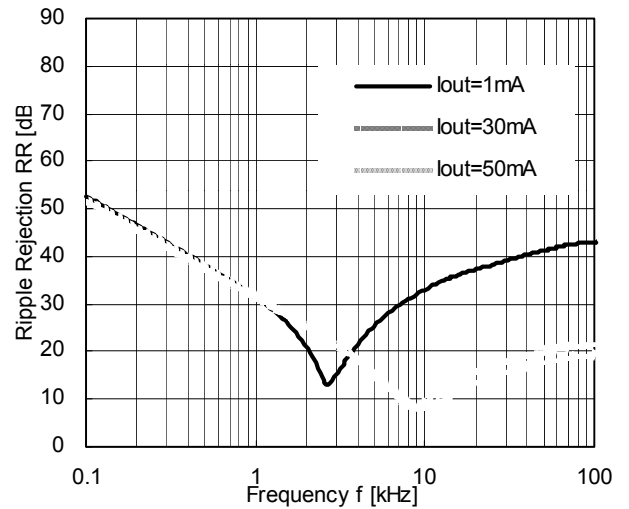

R1160N151X ECO=H

V_{IN}=2.5VDC+0.2Vp-p, C_{IN}; none, C_{OUT}=tantal2.2μF

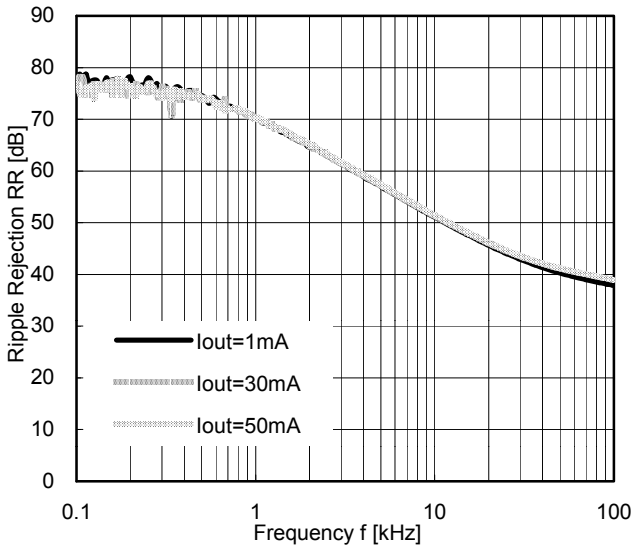

R1160N151X ECO=L

V_{IN}=2.5VDC+0.2Vp-p, C_{IN}; none, C_{OUT}=tantal2.2μF

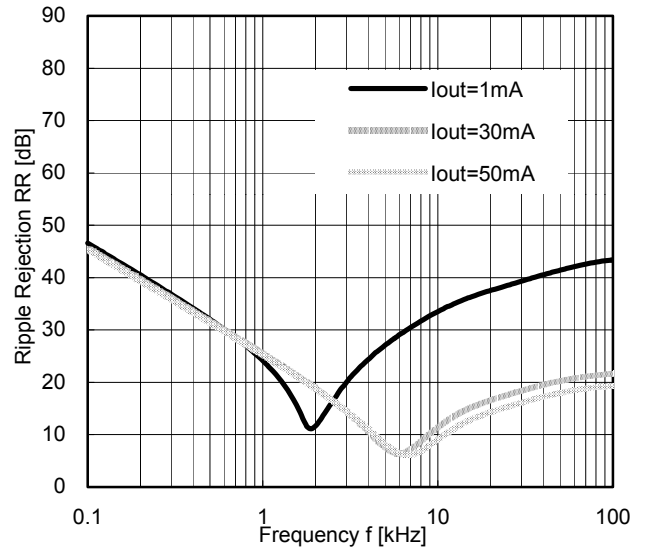

R1160N261X ECO=H

V_{IN}=3.6VDC+0.2Vp-p, C_{IN}; none, C_{OUT}=tantal1.0μF

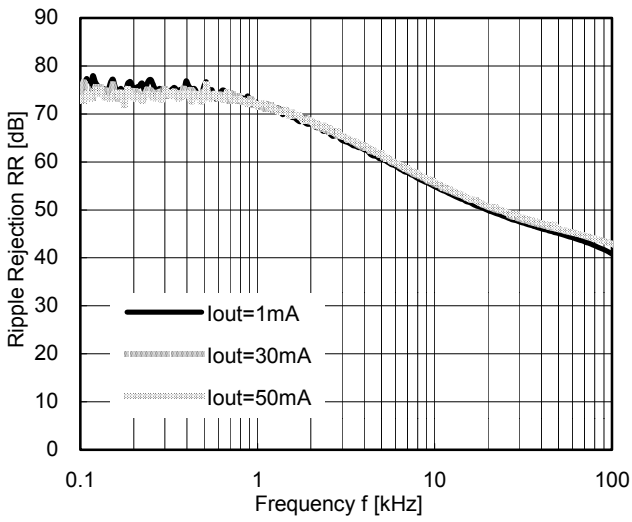

R1160N261X ECO=L

V_{IN}=3.6VDC+0.2Vp-p, C_{IN}; none, C_{OUT}=tantal1.0μF

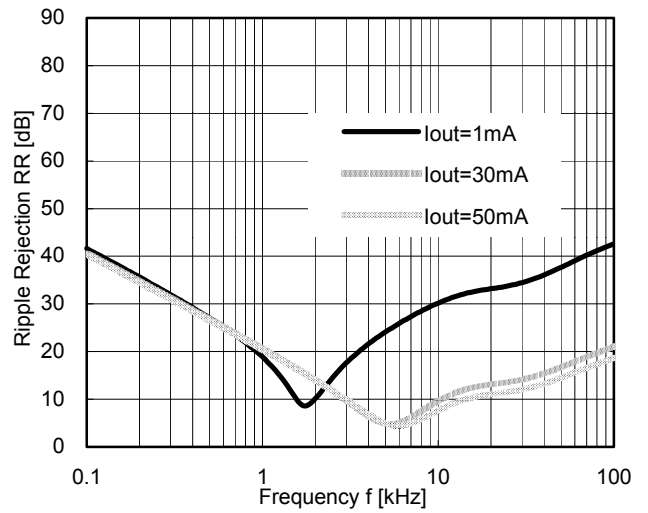

R1160N261X ECO=H

V_{IN}=3.6VDC+0.2Vp-p, C_{IN}; none, C_{OUT}=tantal2.2μF

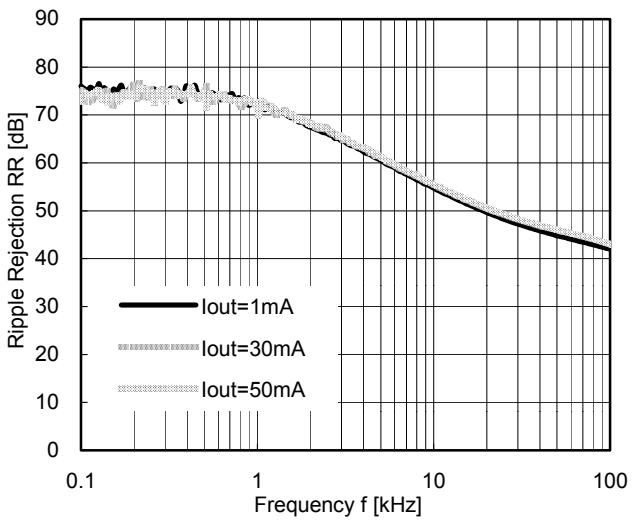

R1160N261X ECO=L

V_{IN}=3.6VDC+0.2Vp-p, C_{IN}; none, C_{OUT}=tantal2.2μF

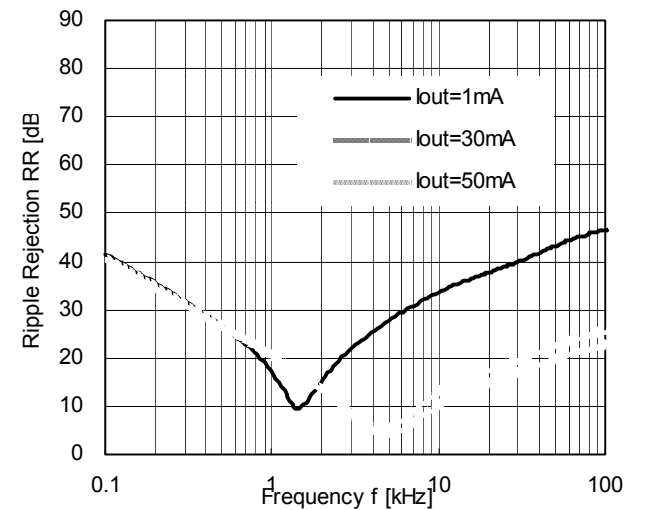

R1160N331X ECO=H

V_{IN}=4.3VDC+0.2Vp-p, C_{IN}; none, C_{OUT}=tantal1.0μF

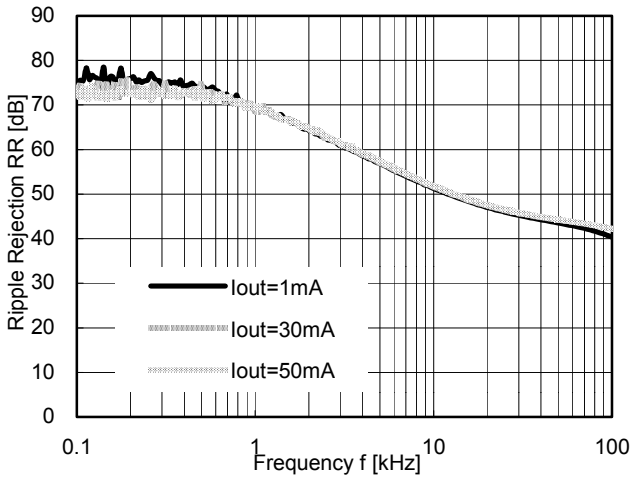

R1160N331X ECO=L

V_{IN}=4.3VDC+0.2Vp-p, C_{IN}; none, C_{OUT}=tantal1.0μF

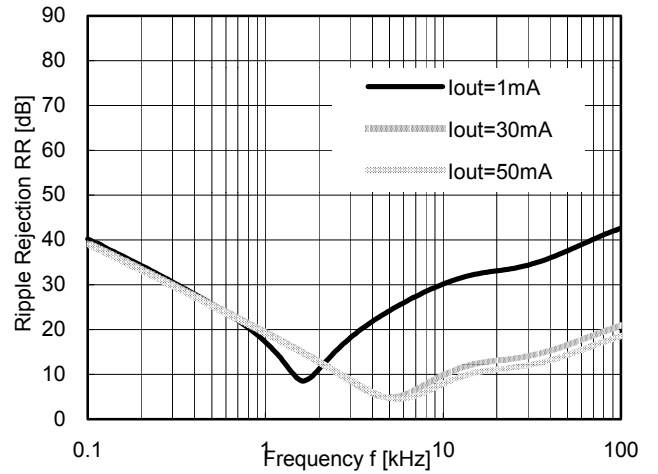

R1160N331X ECO=H

V_{IN}=4.3VDC+0.2Vp-p, C_{IN}; none, C_{OUT}=tantal2.2μF

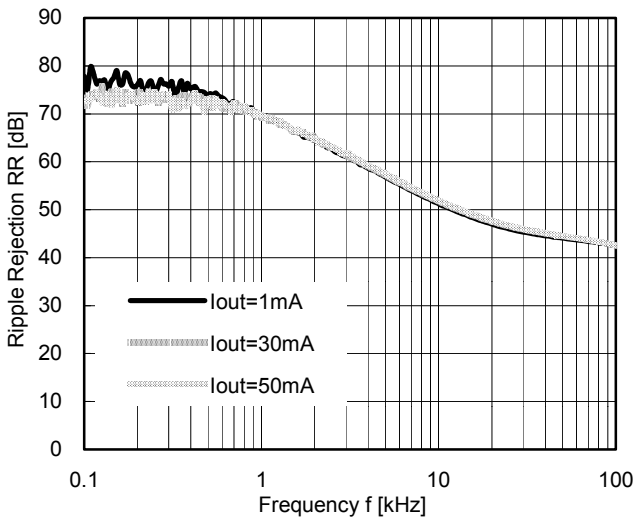

R1160N331X ECO=L

V_{IN}=4.3VDC+0.2Vp-p, C_{IN}; none, C_{OUT}=tantal2.2μF

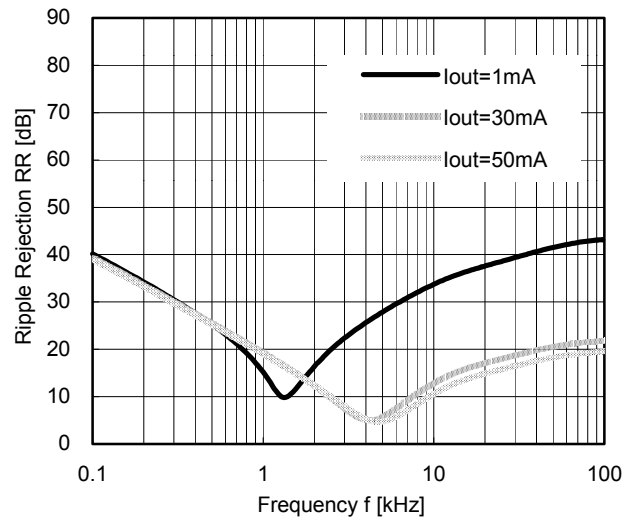

10) Input Transient Response

R1160N261X ECO=H

I_{OUT}=30mA, t_r=t_f=5μs, C_{OUT}=tantal1.0μF

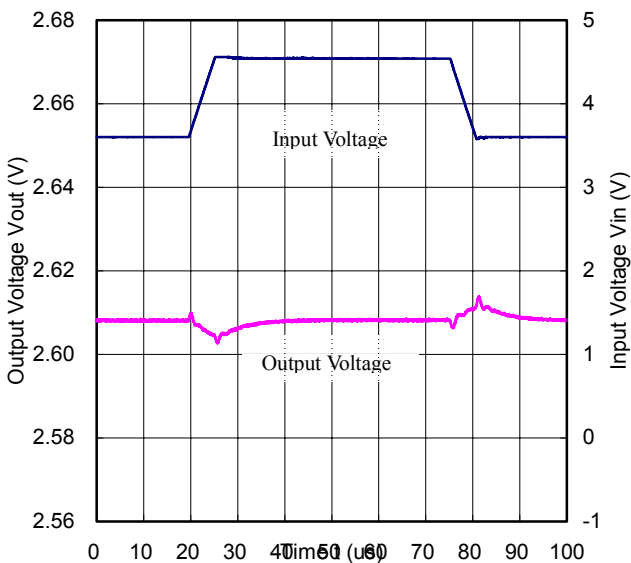

R1160N261X ECO=L

I_{OUT}=10mA, t_r=t_f=5μs, C_{OUT}=tantal1.0μF

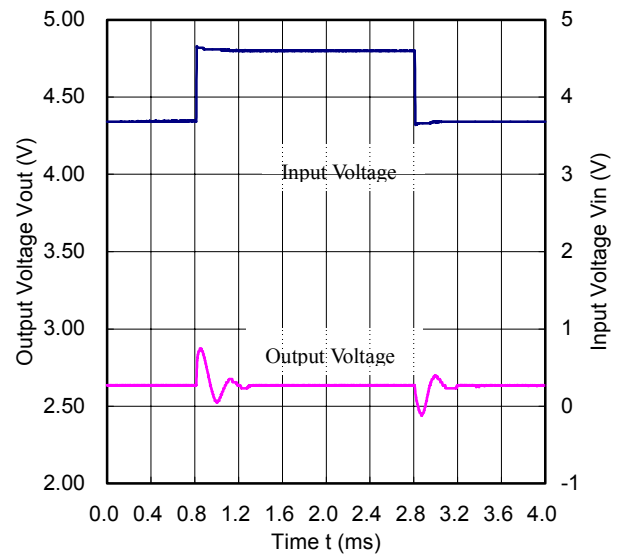

R1160N261X ECO=H

I_{OUT}=30mA, tr=tf=5μs, C_{OUT}= tantal 2.2μF

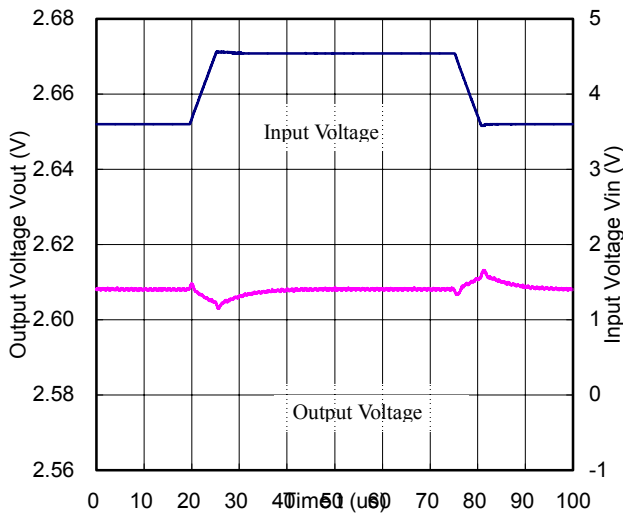

R1160N261X ECO=L

I_{OUT}=10mA, tr=tf=5μs, C_{OUT}= tantal 2.2μF

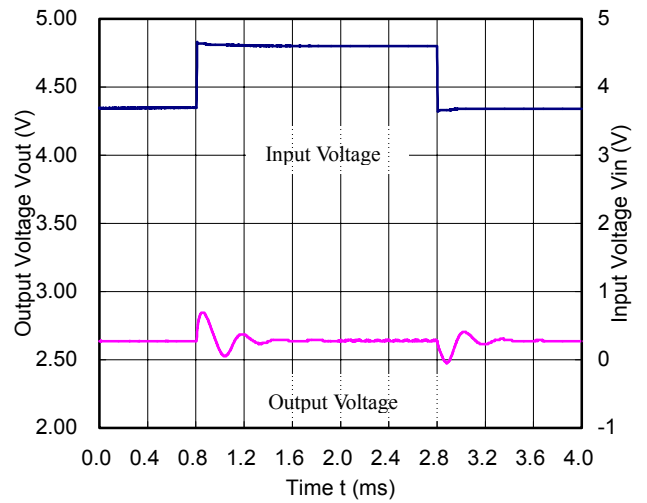

R1160N261X ECO=H

I_{OUT}=30mA, tr=tf=5μs, C_{OUT}= tantal 4.7μF

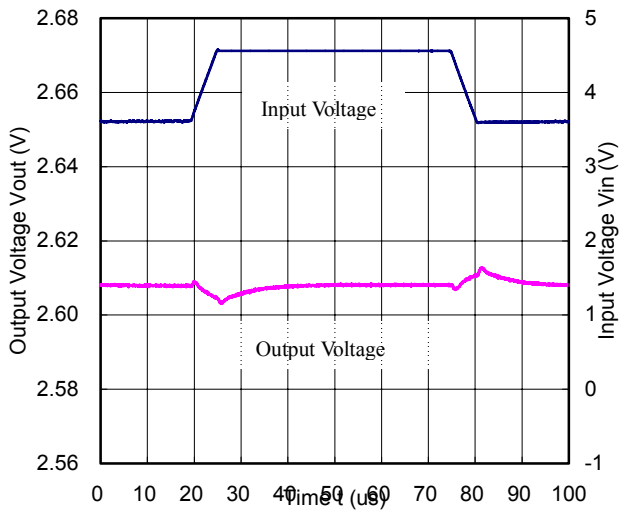

R1160N261X ECO=L

I_{OUT}=10mA, tr=tf=5μs, C_{OUT}= tantal 4.7μF

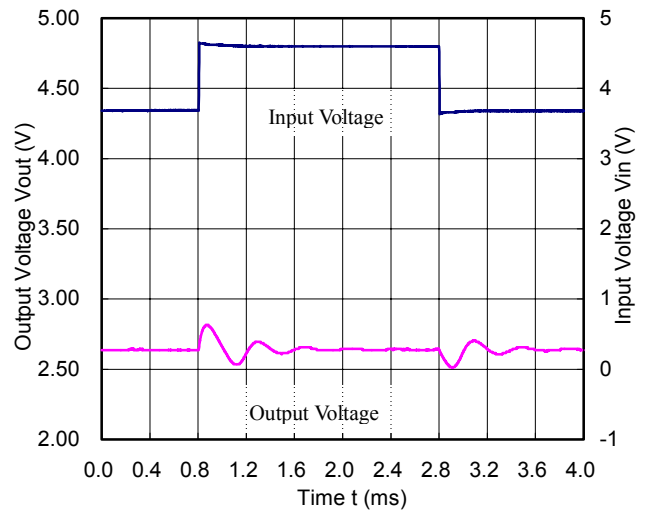

11) Load Transient Response

R1160n261x Eco=H

V_{IN}=3.6V, C_{IN}=Tantal 1.0μF, C_{OUT}= Tantal 1.0μF

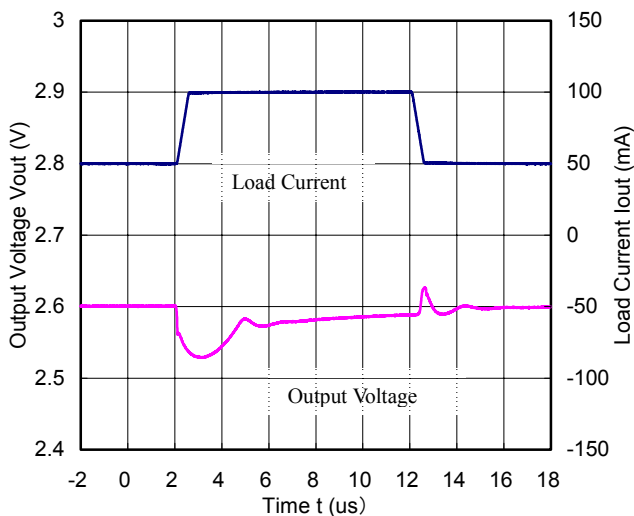

R1160n261x Eco=L

V_{IN}=3.6V, C_{IN}=Tantal 1.0μF, C_{OUT}= Tantal 1.0μF

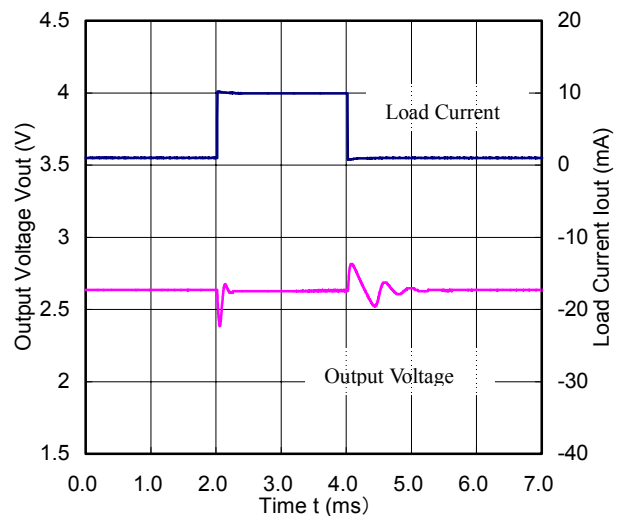

R1160N261X ECO=H

V_{IN}=3.6V, C_{IN}=tantal 1.0μF, C_{OUT}= tantal 2.2μF

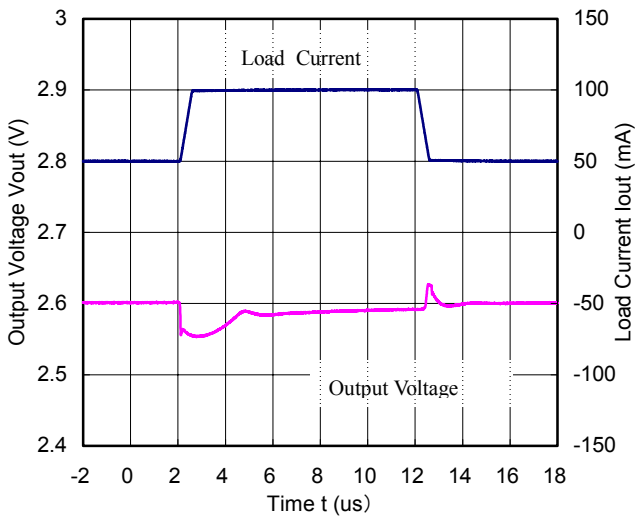

R1160N261X ECO=L

V_{IN}=3.6V, C_{IN}=tantal 1.0μF, C_{OUT}= tantal 2.2μF

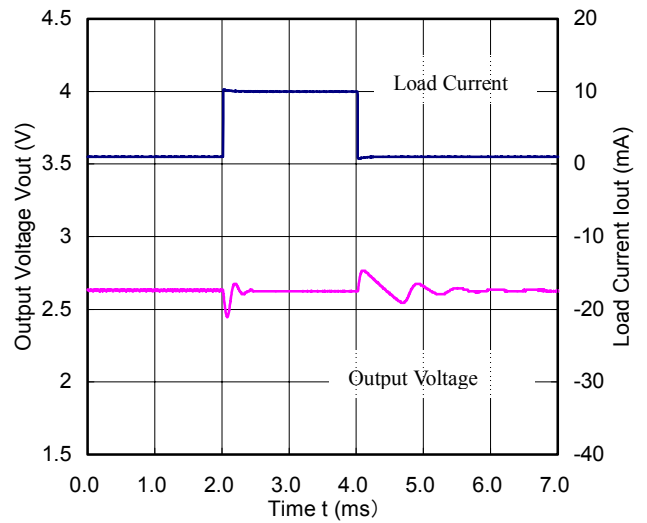

R1160N261X ECO=H

V_{IN}=3.6V, C_{IN}=tantal 1.0μF, C_{OUT}= tantal 4.7μF

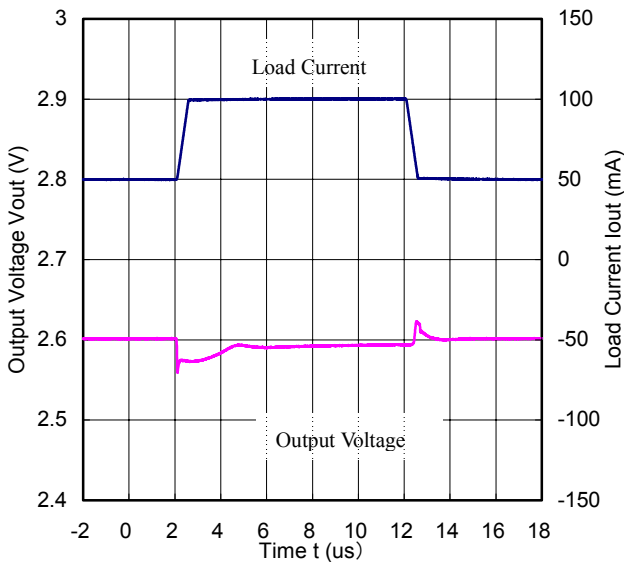

R1160N261X ECO=L

V_{IN}=3.6V, C_{IN}=tantal 1.0μF, C_{OUT}= tantal 4.7μF

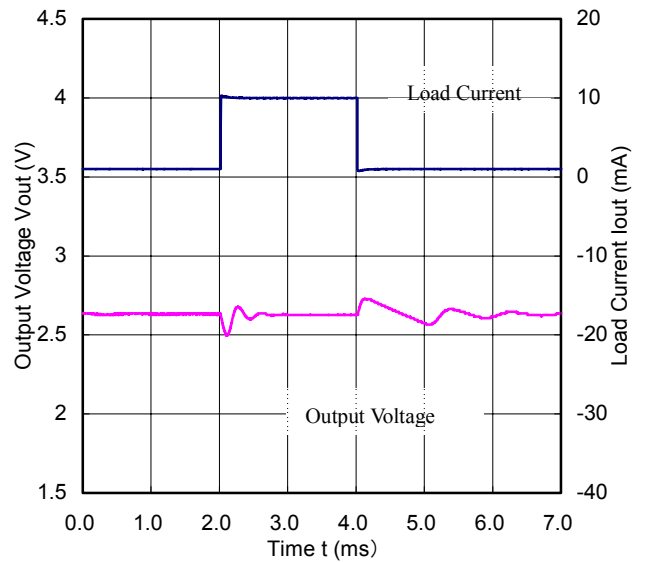

12) Turn on speed with CE pin

R1160N081B ECO=H

V_{IN}=1.8V, C_{IN}=tantal 1.0μF, C_{OUT}= tantal 2.2μF

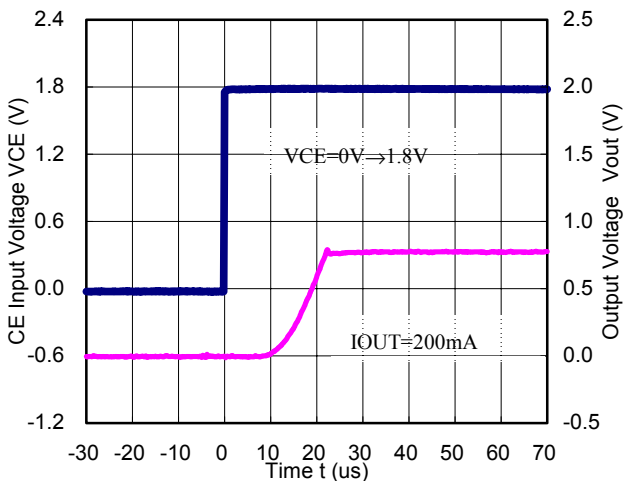

R1160N081B ECO=L

V_{IN}=1.8V, C_{IN}=tantal 1.0μF, C_{OUT}= tantal 2.2μF

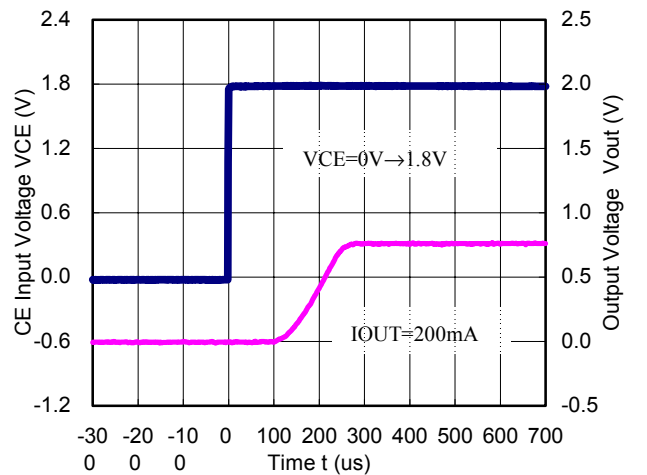

R1160N151B ECO=H

V_{IN}=2.5V, C_{IN}=tantal 1.0μF, C_{OUT}= tantal 2.2μF

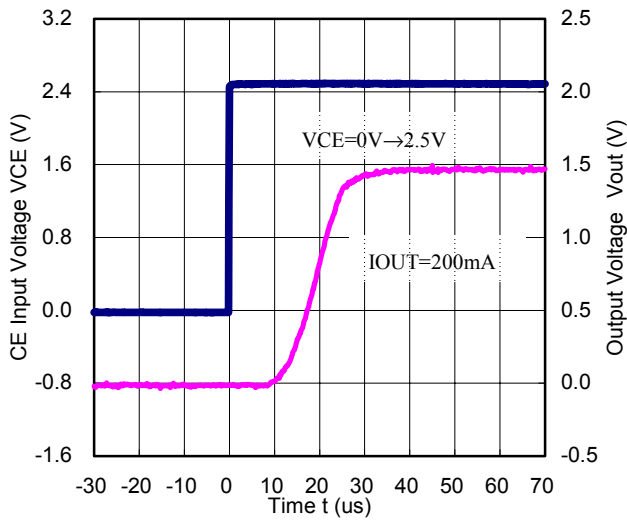

R1160N151B ECO=L

V_{IN}=2.5V, C_{IN}=tantal 1.0μF, C_{OUT}= tantal 2.2μF

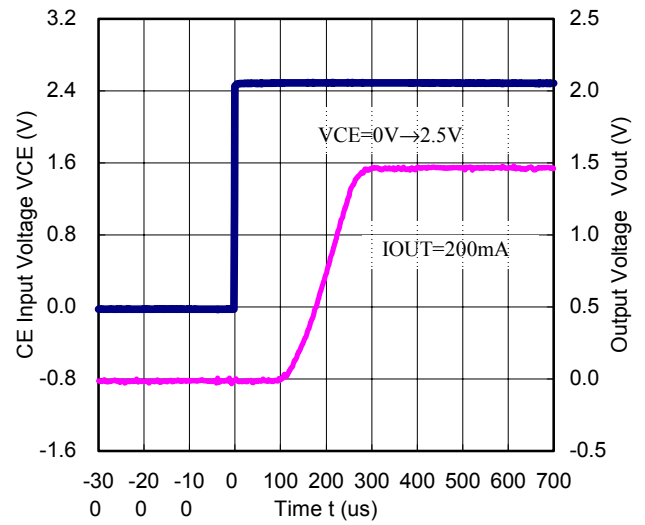

R1160N261B ECO=H

V_{IN}=3.6V, C_{IN}=tantal 1.0μF, C_{OUT}= tantal 2.2μF

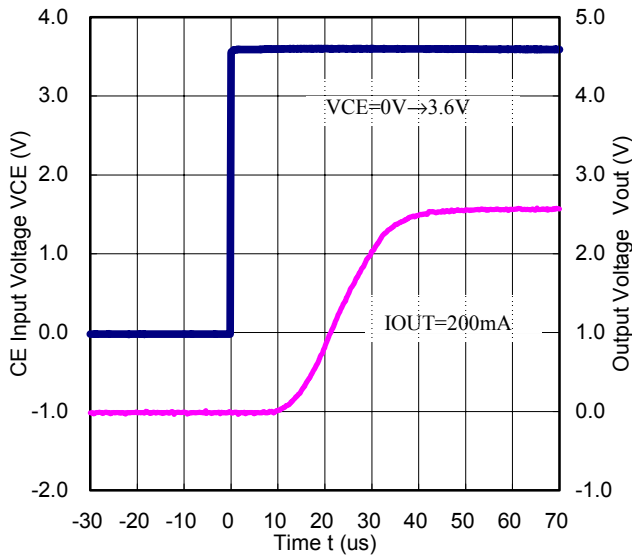

R1160N261B ECO=L

V_{IN}=3.6V, C_{IN}=tantal 1.0μF, C_{OUT}= tantal 2.2μF

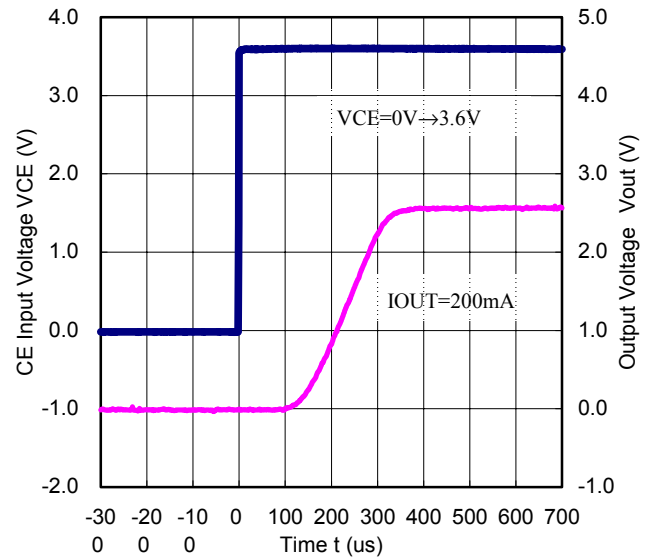

R1160N331B ECO=H

V_{IN}=4.3V, C_{IN}=tantal 1.0μF, C_{OUT}= tantal 2.2μF

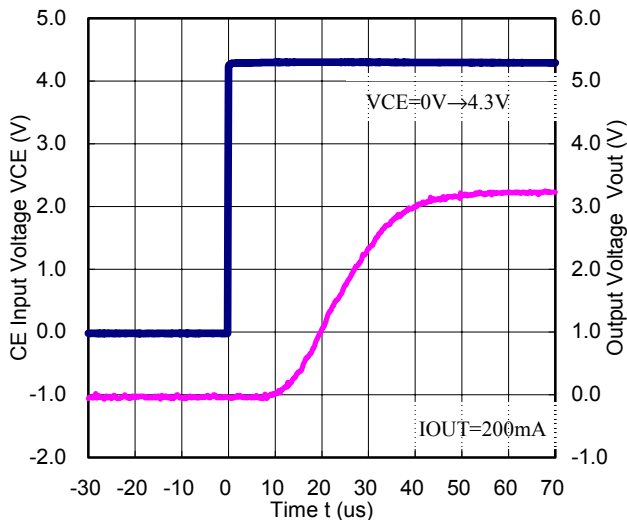

R1160N331B ECO=L

V_{IN}=4.3V, C_{IN}=tantal 1.0μF, C_{OUT}= tantal 2.2μF

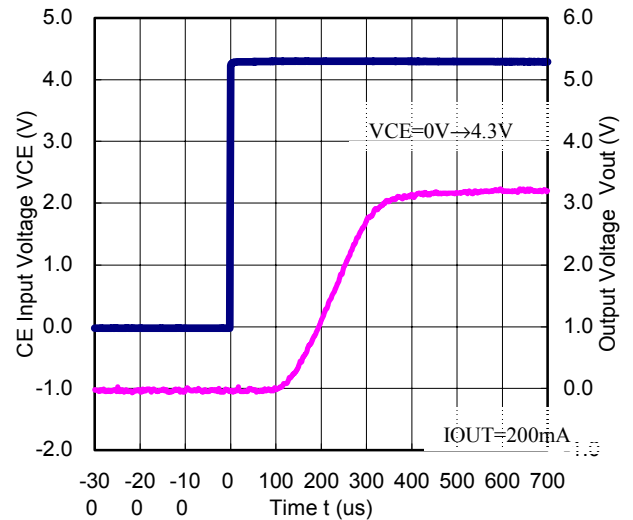

13) Output Voltage at Mode alternative point

R1160N101X

VIN=1.3V, CIN=tantal 1.0μF, COUT= tantal 2.2μF

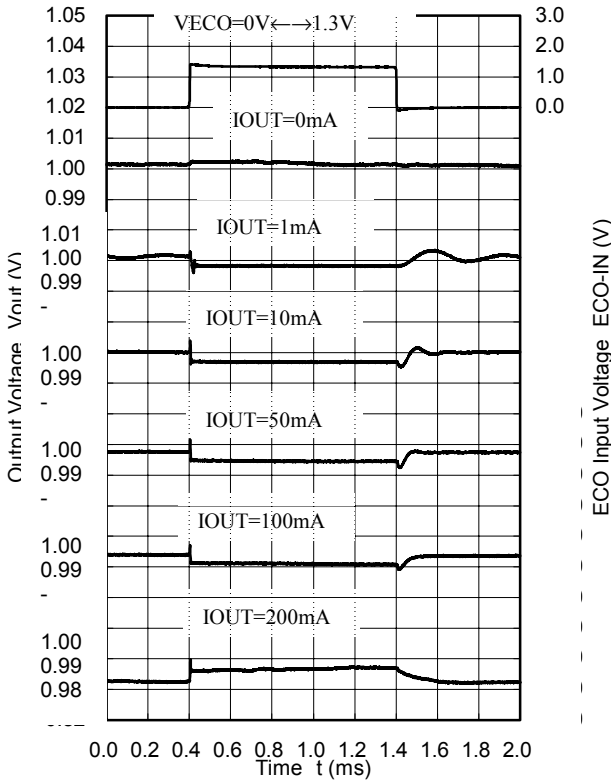

R1160N101X

VIN=2.0V, CIN=tantal 1.0μF, COUT= tantal 2.2μF

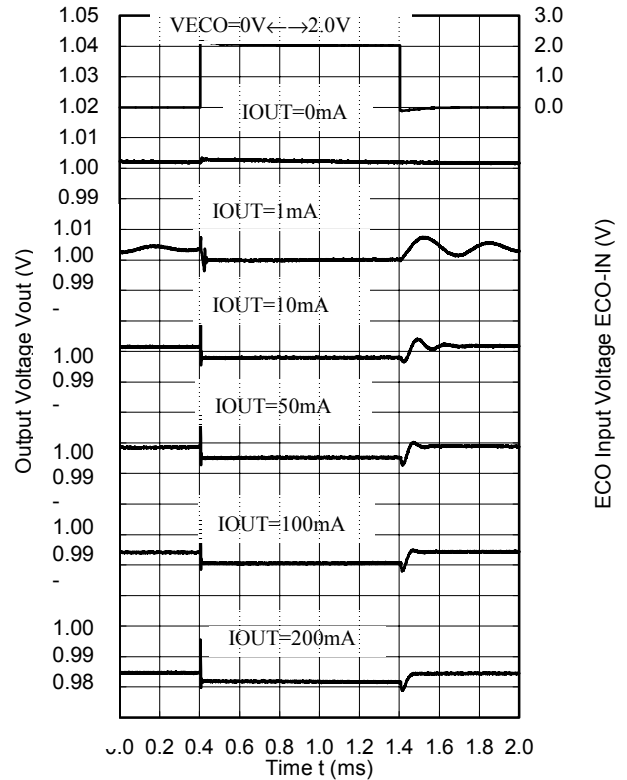

R1160N261X

VIN=2.9V, CIN=tantal 1.0μF, COUT= tantal 2.2μF

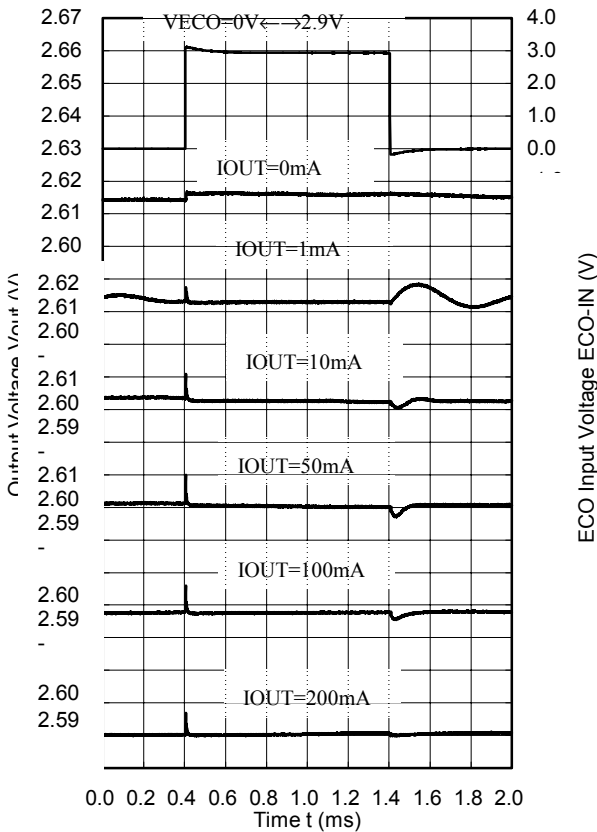

R1160N261X

VIN=3.6V, CIN=tantal 1.0μF, COUT= tantal 2.2μF

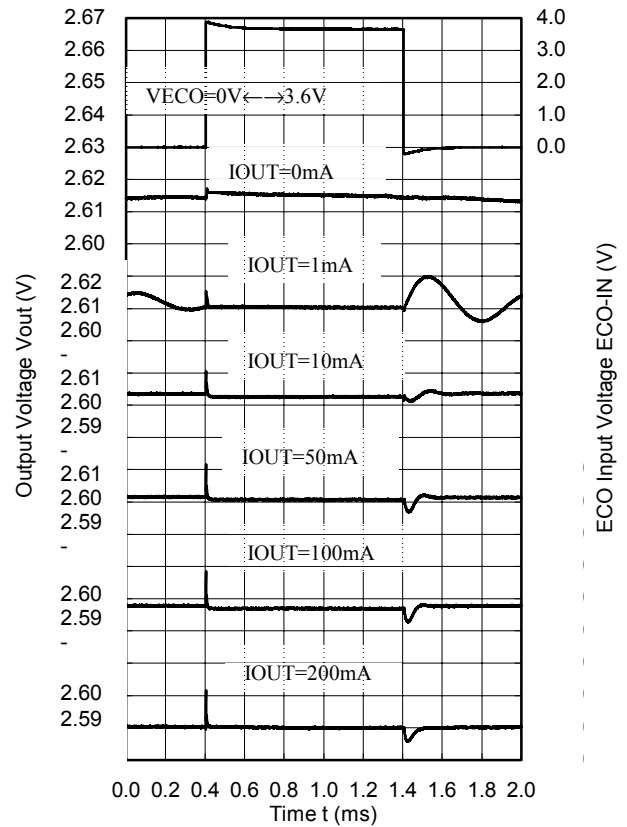

TECHNICAL NOTES

When using these ICs, consider the following points:

In these ICs, phase compensation is made for securing stable operation even if the load current is varied. For this purpose, be sure to use a capacitor C_{OUT} with good frequency characteristics and ESR (Equivalent Series Resistance) of which is in the range described as follows:

The relations between I_{OUT} (Output Current) and ESR of Output Capacitor are shown below. The conditions when the white noise level is under $40\mu V(Avg.)$ are marked as the hatched area in the graph.

<Test conditions>

- (1) Frequency band: 10Hz to 2MHz
- (2) Temperature: 25°C

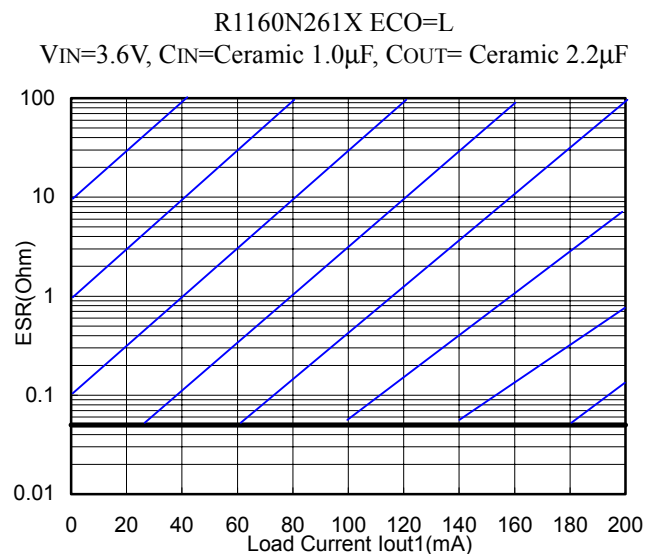
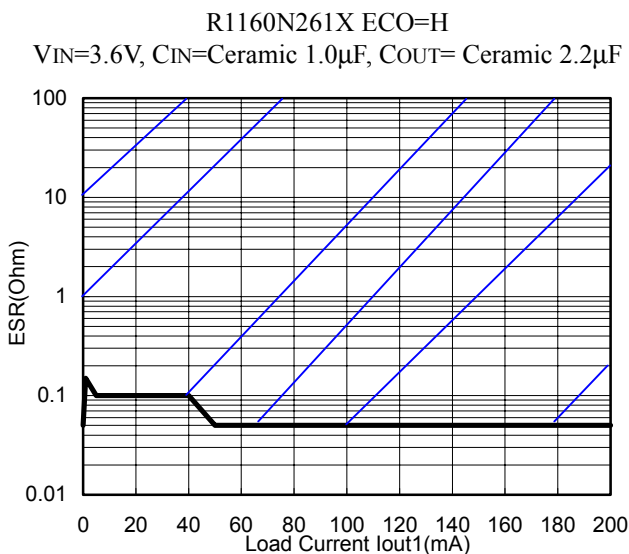
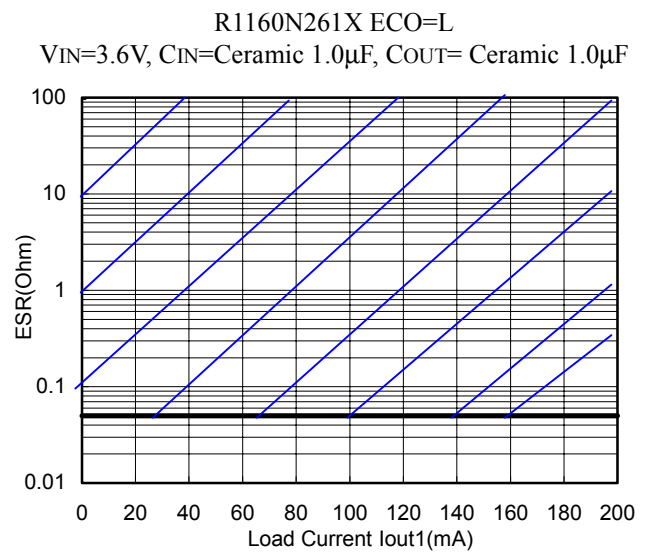
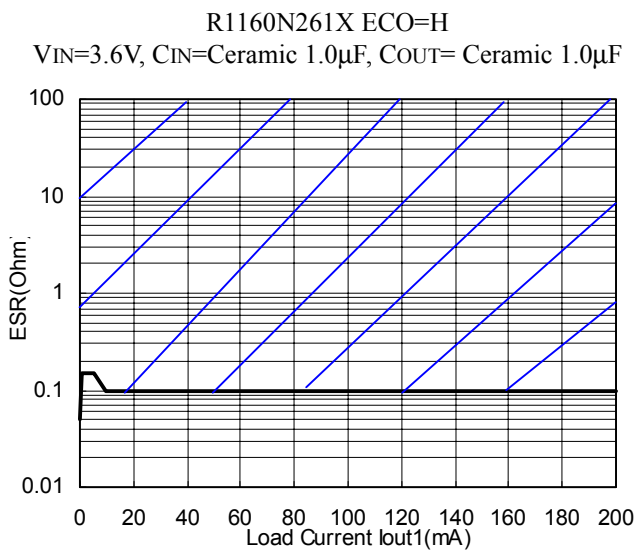

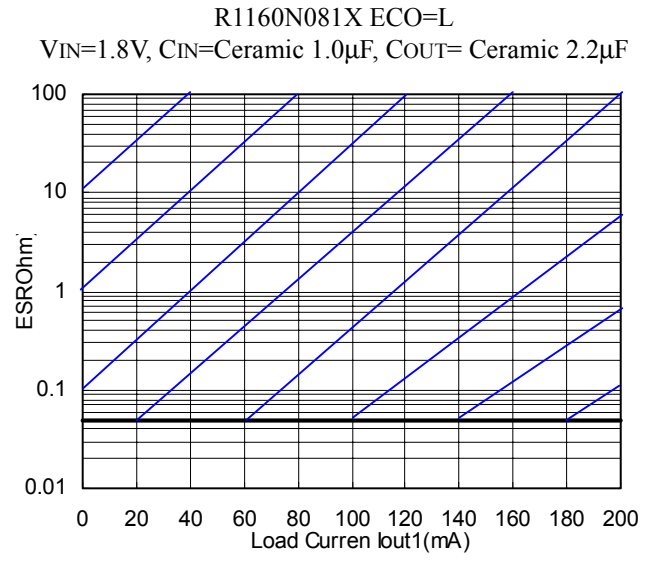
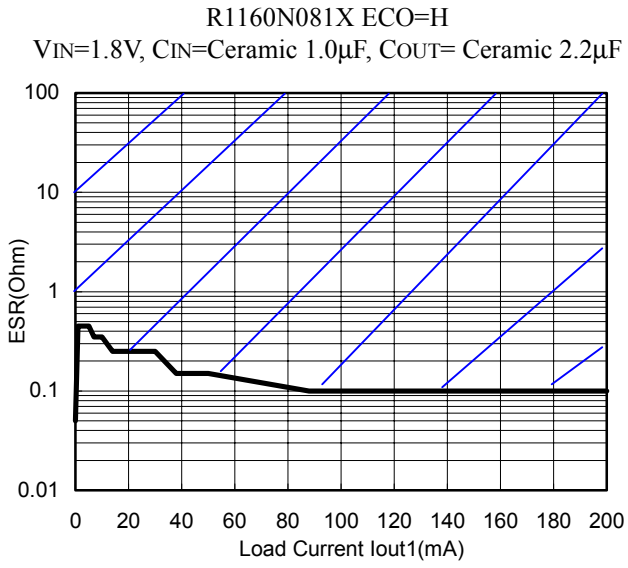



Компания «ЭлектроПласт» предлагает заключение долгосрочных отношений при поставках импортных электронных компонентов на взаимовыгодных условиях!

Наши преимущества:

- Оперативные поставки широкого спектра электронных компонентов отечественного и импортного производства напрямую от производителей и с крупнейших мировых складов;
- Поставка более 17-ти миллионов наименований электронных компонентов;
- Поставка сложных, дефицитных, либо снятых с производства позиций;
- Оперативные сроки поставки под заказ (от 5 рабочих дней);
- Экспресс доставка в любую точку России;
- Техническая поддержка проекта, помощь в подборе аналогов, поставка прототипов;
- Система менеджмента качества сертифицирована по Международному стандарту ISO 9001;
- Лицензия ФСБ на осуществление работ с использованием сведений, составляющих государственную тайну;
- Поставка специализированных компонентов (Xilinx, Altera, Analog Devices, Intersil, Interpoint, Microsemi, Aeroflex, Peregrine, Syfer, Eurofarad, Texas Instrument, Miteq, Cobham, E2V, MA-COM, Hittite, Mini-Circuits, General Dynamics и др.);

Помимо этого, одним из направлений компании «ЭлектроПласт» является направление «Источники питания». Мы предлагаем Вам помощь Конструкторского отдела:

- Подбор оптимального решения, техническое обоснование при выборе компонента;
- Подбор аналогов;
- Консультации по применению компонента;
- Поставка образцов и прототипов;
- Техническая поддержка проекта;
- Защита от снятия компонента с производства.



Как с нами связаться

Телефон: 8 (812) 309 58 32 (многоканальный)

Факс: 8 (812) 320-02-42

Электронная почта: org@eplast1.ru

Адрес: 198099, г. Санкт-Петербург, ул. Калинина, дом 2, корпус 4, литера А.