

## ISL6236A

High-Efficiency, Quad-Output, Main Power Supply Controllers for Notebook Computers

FN6453  
Rev 3.00  
March 18, 2008

The ISL6236A dual step-down, switch-mode power-supply (SMPS) controller generates logic-supply voltages in battery-powered systems. The ISL6236A includes two pulse-width modulation (PWM) controllers, 5V/3.3V and 1.5V/1.05V. The output of SMPS1 can also be adjusted from 0.7V to 5.5V. The SMPS2 output can be adjusted from 0V to 2.5V by setting REFIN2 voltage. An optional external charge pump can be monitored through SECFB. This device features a linear regulator providing 3.3V/5V, or adjustable from 0.7V to 4.5V output via LDOREFIN. The linear regulator provides up to 100mA output current with automatic linear-regulator bootstrapping to the BYP input. When in switchover, the LDO output can source up to 200mA. The ISL6236A includes on-board power-up sequencing, the power-good (POK) outputs, digital soft-start, and internal soft-stop output discharge that prevents negative voltages on shutdown.

A constant on-time PWM control scheme operates without sense resistors and provides 100ns response to load transients while maintaining a relatively constant switching frequency. The unique ultrasonic pulse-skipping mode maintains the switching frequency above 25kHz, which eliminates noise in audio applications. Other features include pulse skipping, which maximizes efficiency in light-load applications, and fixed-frequency PWM mode, which reduces RF interference in sensitive applications.

### Ordering Information

PART NUMBER (Note)	PART MARKING	TEMP RANGE (°C)	PACKAGE (Pb-free)	PKG. DWG. #
ISL6236AIRZ	ISL6236 AIRZ	-40 to +100	32 Ld 5x5 QFN	L32.5x5B
ISL6236AIRZ-T*	ISL6236 AIRZ	-40 to +100	32 Ld 5x5 QFN (Tape and Reel)	L32.5x5B

\*Please refer to TB347 for details on reel specifications.

NOTE: These Intersil Pb-free plastic packaged products employ special Pb-free material sets; molding compounds/die attach materials and 100% matte tin plate PLUS ANNEAL - e3 termination finish, which is RoHS compliant and compatible with both SnPb and Pb-free soldering operations. Intersil Pb-free products are MSL classified at Pb-free peak reflow temperatures that meet or exceed the Pb-free requirements of IPC/JEDEC J STD-020.

### Features

- Wide Input Voltage Range 4.5V to 25V
- Dual Fixed 1.05V/3.3V and 1.5V/5.0V Outputs or Adjustable 0.7V to 5.5V (SMPS1) and 0V to 2.5V (SMPS2),  $\pm 1.5\%$  Accuracy
- Secondary Feedback Input (Maintains Charge Pump Voltage)
- 1.7ms Digital Soft-Start and Independent Shutdown
- Fixed 3.3V/5.0V, or Adjustable Output 0.7V to 4.5V,  $\pm 1.5\%$  (LDO): 200mA
- 3.3V Reference Voltage  $\pm 2.0\%$ : 5mA
- 2.0V Reference Voltage  $\pm 1.0\%$ : 50 $\mu$ A
- Constant ON-TIME Control with 100ns Load-Step Response
- Frequency Selectable
- $r_{DS(ON)}$  Current Sensing
- Programmable Current Limit with Foldback Capability
- Selectable PWM, Skip or Ultrasonic Mode
- BOOT Voltage Monitor with Automatic Refresh
- Independent POK1 and POK2 Comparators
- Soft-Start with Pre-Biased Output and Soft-Stop
- Independent ENABLE
- High Efficiency - up to 97%
- Very High Light Load Efficiency (Skip Mode)
- 5mW Quiescent Power Dissipation
- Thermal Shutdown
- Extremely Low Component Count
- Pb-Free (RoHS Compliant)

### Applications

- Notebook and Sub-Notebook Computers
- PDAs and Mobile Communication Devices
- 3-Cell and 4-Cell Li+ Battery-Powered Devices
- DDR1, DDR2, and DDR3 Power Supplies
- Graphic Cards
- Game Consoles
- Telecommunications

**Pinout**

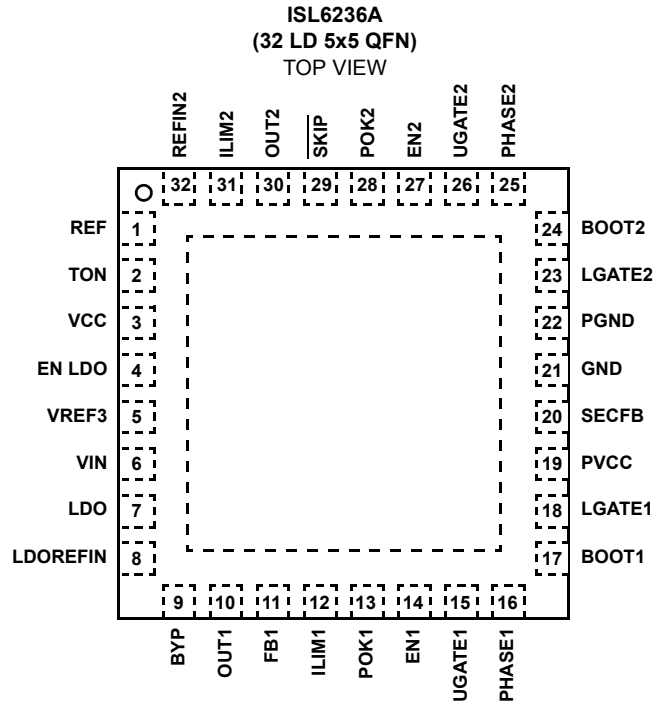

**Absolute Voltage Ratings**

VIN, EN LDO to GND	-0.3V to +27V
BOOT to GND	-0.3V to +33V
BOOT to PHASE	-0.3V to +6V
VCC, EN, SKIP, TON, PVCC, POK to GND	-0.3V to +6V
LDO, FB1, REFIN2, LDOREFIN to GND	-0.3V to (VCC + 0.3V)
OUT, SECFB, VREF3, REF to GND	-0.3V to (VCC + 0.3V)
UGATE to PHASE	-0.3V to (PVCC + 0.3V)
ILIM to GND	-0.3V to (VCC + 0.3V)
LGATE, BYP to GND	-0.3V to (PVCC + 0.3V)
PGND to GND	-0.3V to +0.3V
LDO, REF, VREF3 Short Circuit to GND	Continuous
VCC Short Circuit to GND	1s
LDO Current (Internal Regulator) Continuous	100mA
LDO Current (Switched Over to OUT1) Continuous	+200mA

**Thermal Information**

Thermal Resistance (Typical)	$\theta_{JA}$ (°C/W)	$\theta_{JC}$ (°C/W)
32 Ld QFN (Notes 1, 2)	32	3.0
Operating Temperature Range	-40°C to +100°C	
Junction Temperature	+150°C	
Storage Temperature Range	-65°C to +150°C	
Pb-free reflow profile	see link below	
<a href="http://www.intersil.com/pbfree/Pb-FreeReflow.asp">http://www.intersil.com/pbfree/Pb-FreeReflow.asp</a>		

**CAUTION:** Do not operate at or near the maximum ratings listed for extended periods of time. Exposure to such conditions may adversely impact product reliability and result in failures not covered by warranty.

**NOTES:**

- $\theta_{JA}$  is measured in free air with the component mounted on a high effective thermal conductivity test board with "direct attach" features. See Tech Brief TB379.
- For  $\theta_{JC}$ , the "case temp" location is the center of the exposed metal pad on the package underside.
- Limits established by characterization and are not production tested.
- Parts are 100% tested at +25°C. Temperature limits established by characterization and are not production tested.

**Electrical Specifications** No load on LDO, OUT1, OUT2,  $V_{REF3}$ , and REF,  $V_{IN} = 12V$ ,  $EN2 = EN1 = VCC$ ,  $VBYP = 5V$ ,  $PVCC = 5V$ ,  $VEN\_LDO = 5V$ ,  $T_A = -40^\circ C$  to  $+100^\circ C$ , unless otherwise noted. Typical values are at  $T_A = +25^\circ C$ .

PARAMETER	CONDITIONS	MIN (Note 4)	TYP	MAX (Note 4)	UNITS
<b>MAIN SMPS CONTROLLERS</b>					
$V_{IN}$ Input Voltage Range	LDO in regulation	5.5		25	V
	$V_{IN} = LDO$ , $V_{OUT1} < 4.43V$	4.5		5.5	V
3.3V Output Voltage in Fixed Mode	$V_{IN} = 4.5V$ to 25V, $REFIN2 > (VCC - 1V)$ , $\overline{SKIP} = 5V$	3.285	3.330	3.375	V
1.05V Output Voltage in Fixed Mode	$V_{IN} = 4.5V$ to 25V, $3.0 < REFIN2 < (VCC - 1.1V)$ , $\overline{SKIP} = 5V$	1.038	1.05	1.062	V
1.5V Output Voltage in Fixed Mode	$V_{IN} = 4.5V$ to 25V, $FB1 = VCC$ , $\overline{SKIP} = 5V$	1.482	1.500	1.518	V
5V Output Voltage in Fixed Mode	$V_{IN} = 5.5V$ to 25V, $FB1 = GND$ , $\overline{SKIP} = 5V$	4.975	5.050	5.125	V
FB1 in Output Adjustable Mode	$V_{IN} = 4.5V$ to 25V	0.693	0.700	0.707	V
REFIN2 in Output Adjustable Mode	$V_{IN} = 4.5V$ to 25V	0.7		2.50	V
SECFB Voltage	$V_{IN} = 4.5V$ to 25V	1.920	2.00	2.080	V
SMPS1 Output Voltage Adjust Range	SMPS1	0.70		5.50	V
SMPS2 Output Voltage Adjust Range	SMPS2	0.50		2.50	V
SMPS2 Output Voltage Accuracy (Referred for REFIN2)	$REFIN2 = 0.7V$ to 2.5V, $\overline{SKIP} = VCC$	-1.0		1.0	%
DC Load Regulation	Either SMPS, $\overline{SKIP} = VCC$ , 0A to 5A		-0.1		%
	Either SMPS, $\overline{SKIP} = REF$ , 0A to 5A		-1.7		%
	Either SMPS, $\overline{SKIP} = GND$ , 0A to 5A		-1.5		%
Line Regulation	Either SMPS, $6V < V_{IN} < 24V$		0.005		%/V
Current-Limit Current Source	Temperature = +25°C	4.75	5	5.25	μA
ILIM Adjustment Range		0.2		2	V

**Electrical Specifications** No load on LDO, OUT1, OUT2,  $V_{REF3}$ , and REF,  $V_{IN} = 12V$ , EN2 = EN1 = VCC, VBYP = 5V, PVCC = 5V, VEN\_LDO = 5V,  $T_A = -40^{\circ}C$  to  $+100^{\circ}C$ , unless otherwise noted. Typical values are at  $T_A = +25^{\circ}C$ . (Continued)

PARAMETER	CONDITIONS		MIN (Note 4)	TYP	MAX (Note 4)	UNITS
Current-Limit Threshold (Positive, Default)	ILIM = VCC, GND - PHASE (No temperature compensation)		93	100	107	mV
Current-Limit Threshold (Positive, Adjustable)	GND - PHASE	$V_{ILIM} = 0.5V$	40	50	60	mV
		$V_{ILIM} = 1V$	93	100	107	mV
		$V_{ILIM} = 2V$	185	200	215	mV
Zero-Current Threshold	$\overline{SKIP} = GND, REF, \text{ or } OPEN, GND - PHASE$			3		mV
Current-Limit Threshold (Negative, Default)	$\overline{SKIP} = VCC, GND - PHASE$			-120		mV
Soft-Start Ramp Time	Zero to full limit			1.7		ms
Operating Frequency	$(V_{tON} = GND), \overline{SKIP} = VCC$	SMPS 1		400		kHz
		SMPS 2		500		kHz
	$(V_{tON} = REF \text{ or } OPEN), \overline{SKIP} = VCC$	SMPS 1		400		kHz
		SMPS 2		300		kHz
	$(V_{tON} = VCC), \overline{SKIP} = VCC$	SMPS 1		200		kHz
		SMPS 2		300		kHz
On-Time Pulse Width	$V_{tON} = GND (400kHz/500kHz)$	$V_{OUT1} = 5.00V$	0.895	1.052	1.209	$\mu s$
		$V_{OUT2} = 3.33V$	0.475	0.555	0.635	$\mu s$
	$V_{tON} = REF \text{ or } OPEN (400kHz/300kHz)$	$V_{OUT1} = 5.05V$	0.895	1.052	1.209	$\mu s$
		$V_{OUT2} = 3.33V$	0.833	0.925	1.017	$\mu s$
	$V_{tON} = VCC (200kHz/300kHz)$	$V_{OUT1} = 5.05V$	1.895	2.105	2.315	$\mu s$
		$V_{OUT2} = 3.33V$	0.833	0.925	1.017	$\mu s$
Minimum Off-Time	$T_A = -40^{\circ}C \text{ to } +100^{\circ}C$		200	300	425	ns
	$T_A = -40^{\circ}C \text{ to } +85^{\circ}C$		200	300	410	ns
Maximum Duty Cycle	$V_{tON} = GND$	$V_{OUT1} = 5.05V$		88		%
		$V_{OUT2} = 3.33V$		85		%
	$V_{tON} = REF \text{ or } OPEN$	$V_{OUT1} = 5.05V$		88		%
		$V_{OUT2} = 3.33V$		91		%
	$V_{tON} = VCC$	$V_{OUT1} = 5.05V$		94		%
		$V_{OUT2} = 3.33V$		91		%
Ultrasonic SKIP Operating Frequency	$\overline{SKIP} = REF \text{ or } OPEN$		25	37		kHz
<b>INTERNAL REGULATOR AND REFERENCE</b>						
LDO Output Voltage	BYP = GND, $5.5V < V_{IN} < 25V$ , LDOREFIN < 0.3V, $0 < ILDO < 100mA$		4.925	5.000	5.075	V
	BYP = GND, $4.5V < V_{IN} < 25V$ , LDOREFIN > (VCC - 1V), $0 < ILDO < 100mA$		3.250	3.300	3.350	V
	BYP = GND, $4.5V < V_{IN} < 25V$ , LDOREFIN = 2V, $0 < ILDO < 100mA$		3.94	4.00	4.06	V
LDO Output Accuracy in Adjustable Mode	$V_{IN} = 4.5V \text{ to } 25V, V_{LDOREFIN} = 0.35V \text{ to } 0.5V$				$\pm 2.5$	%
	$V_{IN} = 4.5V \text{ to } 25V, V_{LDOREFIN} = 0.5V \text{ to } 2V$				$\pm 1.5$	%
	$V_{IN} = 5.5V \text{ to } 25V, V_{LDOREFIN} = 2V \text{ to } 2.25V$				$\pm 1.5$	%
LDOREFIN Input Range	$V_{LDO} = 2 \times V_{LDOREFIN}$		0.35		2.25	V

**Electrical Specifications** No load on LDO, OUT1, OUT2,  $V_{REF3}$ , and REF,  $V_{IN} = 12V$ ,  $EN2 = EN1 = VCC$ ,  $VBYP = 5V$ ,  $PVCC = 5V$ ,  $VEN\_LDO = 5V$ ,  $T_A = -40^{\circ}C$  to  $+100^{\circ}C$ , unless otherwise noted. Typical values are at  $T_A = +25^{\circ}C$ . (Continued)

PARAMETER	CONDITIONS	MIN (Note 4)	TYP	MAX (Note 4)	UNITS
LDO Output Current	BYP = GND, $V_{IN} = 4.5V$ to $25V$ (Note 3)			100	mA
LDO Output Current During Switchover to 5V	BYP = 5V, $V_{IN} = 5.5V$ to $25V$ , $LDOREFIN < 0.3V$			200	mA
LDO Output Current During Switchover to 3.3V	BYP = 3.3V, $V_{IN} = 4.5V$ to $25V$ , $LDOREFIN > (VCC - 1V)$			100	mA
LDO Short-Circuit Current	LDO = GND, BYP = GND		200	400	mA
Undervoltage-Lockout Fault Threshold	Rising edge of PVCC		4.35	4.5	V
	Falling edge of PVCC	3.9	4.05		V
LDO 5V Bootstrap Switch Threshold to BYP	Rising edge at BYP regulation point $LDOREFIN = GND$	4.53	4.68	4.83	V
LDO 3.3V Bootstrap Switch Threshold to BYP	Rising edge at BYP regulation point $LDOREFIN = VCC$	3.0	3.1	3.2	V
LDO 5V Bootstrap Switch Equivalent Resistance	LDO to BYP, BYP = 5V, $LDOREFIN > (VCC - 1V)$ (Note 3)		0.7	1.5	$\Omega$
LDO 3.3V Bootstrap Switch Equivalent Resistance	LDO to BYP, BYP = 3.3V, $LDOREFIN < 0.3V$ (Note 3)		1.5	3.0	$\Omega$
VREF3 Output Voltage	No external load, $VCC > 4.5V$	3.235	3.300	3.365	V
	No external load, $VCC < 4.0V$	3.220	3.300	3.380	V
VREF3 Load Regulation	$0 < I_{LOAD} < 5mA$		10		mV
VREF3 Current Limit	VREF3 = GND		10	17	mA
REF Output Voltage	No external load	1.980	2.000	2.020	V
REF Load Regulation	$0 < I_{LOAD} < 50\mu A$		10		mV
REF Sink Current	REF in regulation	10			$\mu A$
VIN Operating Supply Current	Both SMPSs on, $FB1 = \overline{SKIP} = GND$ , $REFIN2 = VCC$ $V_{OUT1} = BYP = 5.3V$ , $V_{OUT2} = 3.5V$		25	50	$\mu A$
VIN Standby Supply Current	$V_{IN} = 5.5V$ to $25V$ , both SMPSs off, EN LDO = VCC		180	250	$\mu A$
VIN Shutdown Supply Current	$V_{IN} = 4.5V$ to $25V$ , $EN1 = EN2 = EN$ LDO = 0V		20	30	$\mu A$
Quiescent Power Consumption	Both SMPSs on, $FB1 = \overline{SKIP} = GND$ , $REFIN2 = VCC$ , $V_{OUT1} = BYP = 5.3V$ , $V_{OUT2} = 3.5V$		5	7	mW
<b>FAULT DETECTION</b>					
Overvoltage Trip Threshold	FB1 with respect to nominal regulation point	+8	+11	+14	%
	REFIN2 with respect to nominal regulation point	+12	+16	+20	%
Overvoltage Fault Propagation Delay	FB1 or REFIN2 delay with 50mV overdrive		10		$\mu s$
POK_ Threshold	FB1 or REFIN2 with respect to nominal output, falling edge, typical hysteresis = 1%	-12	-9	-6	%
POK_ Propagation Delay	Falling edge, 50mV overdrive		10		$\mu s$
POK_ Output Low Voltage	$I_{SINK} = 4mA$			0.2	V
POK_ Leakage Current	High state, forced to 5.5V			1	$\mu A$
Thermal-Shutdown Threshold			+150		$^{\circ}C$
Out-Of-Bound Threshold	FB1 or REFIN2 with respect to nominal output voltage		5		%
Output Undervoltage Shutdown Threshold	FB1 or REFIN2 with respect to nominal output voltage	65	70	75	%
Output Undervoltage Shutdown Blanking Time	From EN signal	10	20	30	ms

**Electrical Specifications** No load on LDO, OUT1, OUT2,  $V_{REF3}$ , and REF,  $V_{IN} = 12V$ ,  $EN2 = EN1 = VCC$ ,  $VBYP = 5V$ ,  $PVCC = 5V$ ,  $VEN\_LDO = 5V$ ,  $T_A = -40^{\circ}C$  to  $+100^{\circ}C$ , unless otherwise noted. Typical values are at  $T_A = +25^{\circ}C$ . (Continued)

PARAMETER	CONDITIONS	MIN (Note 4)	TYP	MAX (Note 4)	UNITS
<b>INPUTS AND OUTPUTS</b>					
FB1 Input Voltage	Low level			0.3	V
	High level	VCC - 1.0			V
REFIN2 Input Voltage	OUT2 Dynamic Range, $V_{OUT2} = V_{REFIN2}$	0.5		2.50	V
	Fixed OUT2 = 1.05V	3.0		VCC - 1.1	V
	Fixed OUT2 = 3.3V	VCC - 1.0			V
LDOREFIN Input Voltage	Fixed LDO = 5V			0.30	V
	LDO Dynamic Range, $V_{LDO} = 2 \times V_{LDOREFIN}$	0.35		2.25	V
	Fixed LDO = 3.3V	VCC - 1.0			V
SKIP Input Voltage	Low level (SKIP)			0.8	V
	Float level (ULTRASONIC SKIP)	1.7		2.3	V
	High level (PWM)	2.4			V
TON Input Voltage	Low level			0.8	V
	Float level	1.7		2.3	V
	High level	2.4			V
EN1, EN2 Input Voltage	Clear fault level/SMPS off level			0.8	V
	Delay start level	1.7		2.3	V
	SMPS on level	2.4			V
EN LDO Input Voltage	Rising edge	1.2	1.6	2.0	V
	Falling edge	0.94	1.00	1.06	V
Input Leakage Current	$V_{tON} = 0V$ or $5V$	-1		+1	$\mu A$
	$V_{EN} = V_{EN\_LDO} = 0V$ or $5V$	-0.1		+0.1	$\mu A$
	$V_{SKIP} = 0V$ or $5V$	-1		+1	$\mu A$
	$V_{FB1} = V_{SECFB} = 0V$ or $5V$	-0.2		+0.2	$\mu A$
	$V_{REFIN} = 0V$ or $2.5V$	-0.2		+0.2	$\mu A$
	$V_{LDOREFIN} = 0V$ or $2.75V$	-0.2		+0.2	$\mu A$
<b>INTERNAL BOOT DIODE</b>					
$V_D$ Forward Voltage	$PVCC - V_{BOOT}$ , $I_F = 10mA$		0.65	0.8	V
I <sub>BOOT LEAKAGE</sub> Leakage Current	$V_{BOOT} = 30V$ , PHASE = 25V, $PVCC = 5V$			500	nA
<b>MOSFET DRIVERS</b>					
UGATE Gate-Driver Sink/Source Current	UGATE1, UGATE2 forced to 2V		2		A
LGATE Gate-Driver Source Current	LGATE1 (source), LGATE2 (source), forced to 2V		1.7		A
LGATE Gate-Driver Sink Current	LGATE1 (sink), LGATE2 (sink), forced to 2V		3.3		A
UGATE Gate-Driver ON-resistance	BOOT_ - PHASE_ forced to 5V (Note 3)		1.5	4.0	$\Omega$
LGATE Gate-Driver ON-resistance	LGATE, high state (pull-up) (Note 3)		2.2	5.0	$\Omega$
	LGATE, low state (pull-down) (Note 3)		0.6	1.5	$\Omega$
Dead Time	LGATE Rising	15	20	35	ns
	UGATE Rising	20	30	50	ns
OUT1, OUT2 Discharge ON-resistance			25	40	$\Omega$

## Pin Descriptions

PIN	NAME	FUNCTION
1	REF	2V Reference Output. Bypass to GND with a 0.1 $\mu$ F (min) capacitor. REF can source up to 50 $\mu$ A for external loads. Loading REF degrades FB and output accuracy according to the REF load-regulation error.
2	TON	Frequency Select Input. Connect to GND for 400kHz/500kHz operation. Connect to REF (or leave OPEN) for 400kHz/300kHz operation. Connect to VCC for 200kHz/300kHz operation (5V/3.3V SMPS switching frequencies, respectively).
3	VCC	Analog Supply Voltage Input for PWM Core. Bypass to GND with a 1 $\mu$ F ceramic capacitor.
4	EN LDO	LDO Enable Input. The LDO is enabled if EN LDO is within logic high level and disabled if EN LDO is less than the logic low level.
5	VREF3	3.3V Reference Output. VREF3 can source up to 5mA for external loads. Bypass to GND with a 0.01 $\mu$ F capacitor if loaded. Leave open if there is no load.
6	VIN	Power-Supply Input. VIN is used for the constant-on-time PWM on-time one-shot circuits. VIN is also used to power the linear regulators. The linear regulators are powered by SMPS1 if OUT1 is set greater than 4.78V and BYP is tied to OUT1. Connect VIN to the battery input and bypass with a 1 $\mu$ F capacitor.
7	LDO	Linear-Regulator Output. LDO can provide a total of 100mA external loads. The LDO regulates at 5V if LDOREFIN is connected to GND. When the LDO is set at 5V and BYP is within 5V switchover threshold, the internal regulator shuts down and the LDO output pin connects to BYP through a 0.7 $\Omega$ switch. The LDO regulates at 3.3V if LDOREFIN is connected to VCC. When the LDO is set at 3.3V and BYP is within the 3.3V switchover threshold, the internal regulator shuts down and the LDO output pin connects to BYP through a 1.5 $\Omega$ switch. Bypass LDO output with a minimum of 4.7 $\mu$ F ceramic.
8	LDOREFIN	LDO Reference Input. Connect LDOREFIN to GND for fixed 5V operation. Connect LDOREFIN to VCC for fixed 3.3V operation. LDOREFIN can be used to program LDO output voltage from 0.7V to 4.5V. LDO output is two times the voltage of LDOREFIN. There is no switchover in adjustable mode.
9	BYP	BYP is the switchover source voltage for the LDO when LDOREFIN is connected to GND or VCC. Connect BYP to 5V if LDOREFIN is tied to GND. Connect BYP to 3.3V if LDOREFIN is tied to VCC.
10	OUT1	SMPS1 Output Voltage-Sense Input. Connect to the SMPS1 output. OUT1 is an input to the Constant on-time-PWM on-time one-shot circuit. It also serves as the SMPS1 feedback input in fixed-voltage mode.
11	FB1	SMPS1 Feedback Input. Connect FB1 to GND for fixed 5V operation. Connect FB1 to VCC for fixed 1.5V operation. Connect FB1 to a resistive voltage-divider from OUT1 to GND to adjust the output from 0.7V to 5.5V.
12	ILIM1	SMPS1 Current-Limit Adjustment. The GND-PHASE1 current-limit threshold is 1/10th the voltage seen at ILIM1 over a 0.2V to 2V range. There is an internal 5 $\mu$ A current source from VCC to ILIM1. Connect ILIM1 to REF for a fixed 200mV threshold. The logic current limit threshold is default to 100mV value if ILIM1 is higher than VCC - 1V.
13	POK1	SMPS1 Power-Good Open-Drain Output. POK1 is low when the SMPS1 output voltage is more than 10% below the normal regulation point or during soft-start. POK1 is high impedance when the output is in regulation and the soft-start circuit has terminated. POK1 is low in shutdown.
14	EN1	SMPS1 Enable Input. The SMPS1 is enabled if EN1 is greater than the logic high level and disabled if EN1 is less than the logic low level. If EN1 is connected to REF, the SMPS1 starts after the SMPS2 reaches regulation (delay start). Drive EN1 below 0.8V to clear fault level and reset the fault latches.
15	UGATE1	High-Side MOSFET Floating Gate-Driver Output for SMPS1. UGATE1 swings between PHASE1 and BOOT1.
16	PHASE1	Inductor Connection for SMPS1. PHASE1 is the internal lower supply rail for the UGATE1 high-side gate driver. PHASE1 is the current-sense input for the SMPS1.
17	BOOT1	Boost Flying Capacitor Connection for SMPS1. Connect to an external capacitor according to the "Typical Application Circuits" on page 19 (Figures 66, 67 and 68). See "MOSFET Gate Drivers (UGATE, LGATE)" on page 29.
18	LGATE1	SMPS1 Synchronous-Rectifier Gate-Drive Output. LGATE1 swings between GND and PVCC.
19	PVCC	PVCC is the supply voltage for the low-side MOSFET driver LGATE. Connect a 5V power source to the PVCC pin and bypass to PGND with a 1 $\mu$ F MLCC ceramic capacitor. Refer to Figure 70 - A switch connects PVCC to VCC with 10 $\Omega$ when in normal operation and is disconnected when in shutdown mode. An external 10 $\Omega$ resistor from PVCC to VCC is prohibited as it will create a leakage path from VIN to GND in shutdown mode.
20	SECFB	The SECFB is used to monitor the optional external 14V charge pump. Connect a resistive voltage-divider from 14V charge pump output to GND to detect the output. If SECFB drops below the threshold voltage, LGATE1 turns on for 300ns. This will refresh the external charge pump driven by LGATE1 without over-discharging the output voltage.

**Pin Descriptions** (Continued)

PIN	NAME	FUNCTION
21	GND	Analog Ground for both SMPS and LDO. Connect externally to the underside of the exposed pad.
22	PGND	Power Ground for SMPS controller. Connect PGND externally to the underside of the exposed pad.
23	LGATE2	SMPS2 Synchronous-Rectifier Gate-Drive Output. LGATE2 swings between GND and PVCC.
24	BOOT2	Boost Flying Capacitor Connection for SMPS2. Connect to an external capacitor according to the "Typical Application Circuits" on page 19 (Figures 66, 67 and 68). See "MOSFET Gate Drivers (UGATE, LGATE)" on page 29.
25	PHASE2	Inductor Connection for SMPS2. PHASE2 is the internal lower supply rail for the UGATE2 high-side gate driver. PHASE2 is the current-sense input for the SMPS2.
26	UGATE2	High-Side MOSFET Floating Gate-Driver Output for SMPS2. UGATE1 swings between PHASE2 and BOOT2.
27	EN2	SMPS2 Enable Input. The SMPS2 is enabled if EN2 is greater than the logic high level and disabled if EN2 is less than the logic low level. If EN2 is connected to REF, the SMPS2 starts after the SMPS1 reaches regulation (delay start). Drive EN2 below 0.8V to clear fault level and reset the fault latches.
28	POK2	SMP2 Power-Good Open-Drain Output. POK2 is low when the SMPS2 output voltage is more than 10% below the normal regulation point or during soft-start. POK2 is high impedance when the output is in regulation and the soft-start circuit has terminated. POK2 is low in shutdown.
29	$\overline{\text{SKIP}}$	Low-Noise Mode Control. Connect $\overline{\text{SKIP}}$ to GND for normal Idle-Mode (pulse-skipping) operation or to VCC for PWM mode (fixed frequency). Connect to REF or leave floating for ultrasonic skip mode operation.
30	OUT2	SMPS2 Output Voltage-Sense Input. Connect to the SMPS2 output. OUT2 is an input to the Constant on-time-PWM on-time one-shot circuit. It also serves as the SMPS2 feedback input in fixed-voltage mode.
31	ILIM2	SMPS2 Current-Limit Adjustment. The GND-PHASE1 current-limit threshold is 1/10th the voltage seen at ILIM2 over a 0.2V to 2V range. There is an internal 5 $\mu$ A current source from VCC to ILIM2. Connect ILIM2 to REF for a fixed 200mV. The logic current limit threshold is default to 100mV value if ILIM2 is higher than VCC - 1V.
32	REFIN2	Output voltage control for SMPS2. Connect REFIN2 to VCC for fixed 3.3V. Connect REFIN2 to VREF3 for fixed 1.05V. REFIN2 can be used to program SMPS2 output voltage from 0.5V to 2.50V. SMPS2 output voltage is 0V if REFIN2 < 0.5V.

**Typical Performance Curves**

Circuit of Figures 66, 67 and 68, no load on LDO, OUT1, OUT2, VREF3, and REF, V<sub>IN</sub> = 12V, EN2 = EN1 = VCC, V<sub>BYP</sub> = 5V, PVCC = 5V, V<sub>EN\_LDO</sub> = 5V, T<sub>A</sub> = -40°C to +100°C, unless otherwise noted. Typical values are at T<sub>A</sub> = +25°C.

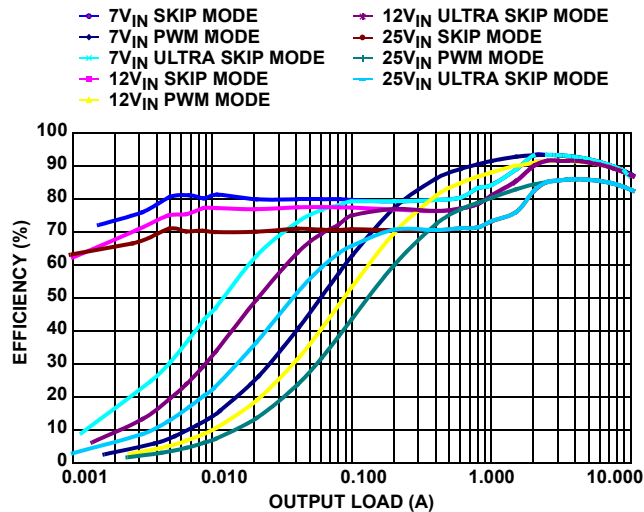

FIGURE 1. V<sub>OUT2</sub> = 1.05V EFFICIENCY vs LOAD (300kHz)

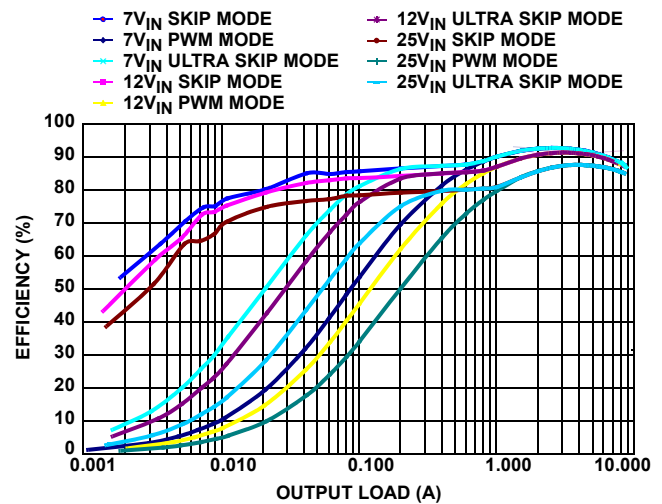

FIGURE 2. V<sub>OUT1</sub> = 1.5V EFFICIENCY vs LOAD (200kHz)



**Typical Performance Curves**

Circuit of Figures 66, 67 and 68, no load on LDO, OUT1, OUT2,  $V_{REF3}$ , and REF,  $V_{IN} = 12V$ ,  $EN2 = EN1 = VCC$ ,  $V_{BYP} = 5V$ ,  $PVCC = 5V$ ,  $V_{EN\_LDO} = 5V$ ,  $T_A = -40^{\circ}C$  to  $+100^{\circ}C$ , unless otherwise noted. Typical values are at  $T_A = +25^{\circ}C$ . (Continued)

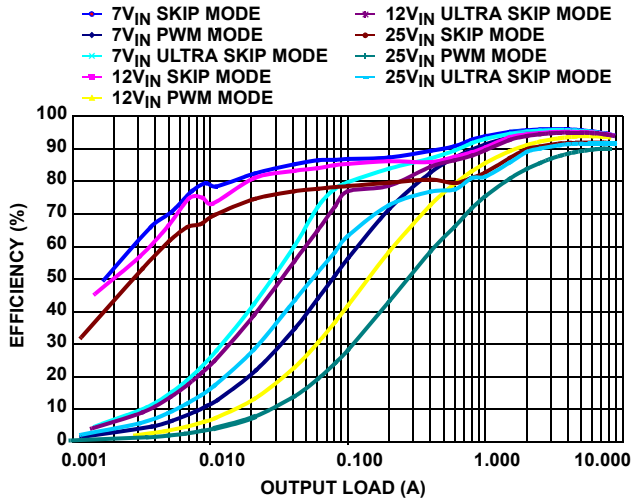

FIGURE 3.  $V_{OUT2} = 3.3V$  EFFICIENCY vs LOAD (500kHz)

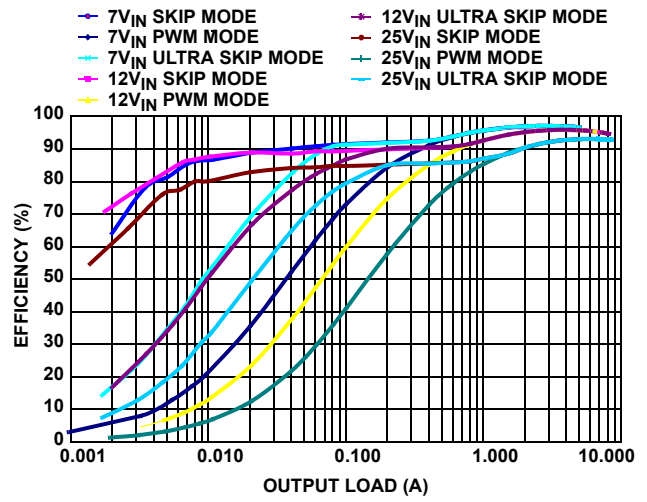

FIGURE 4.  $V_{OUT1} = 5V$  EFFICIENCY vs LOAD (400kHz)

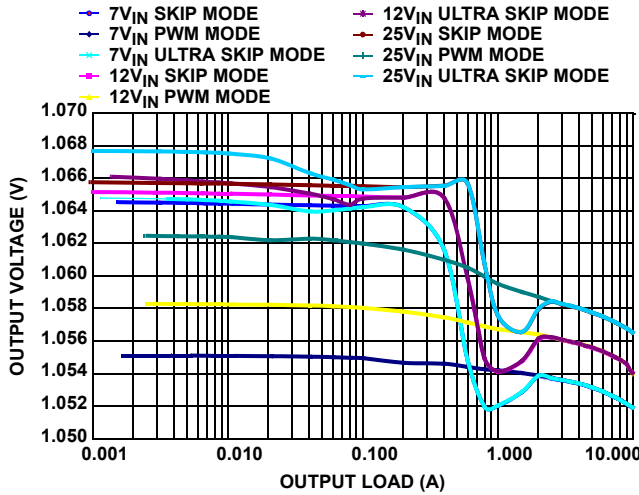

FIGURE 5.  $V_{OUT2} = 1.05V$  REGULATION vs LOAD (300kHz)

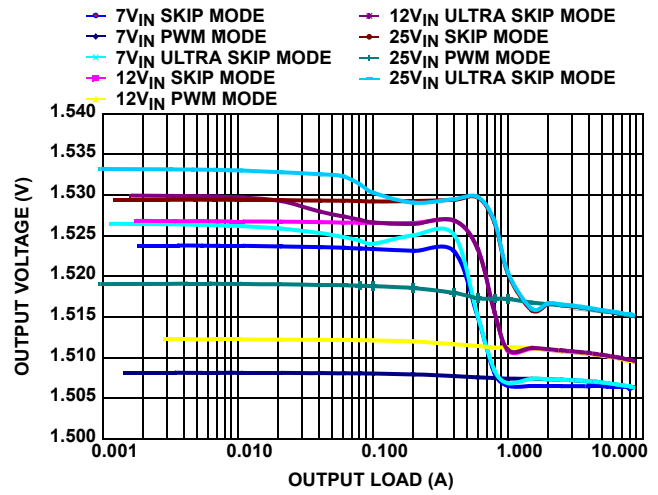

FIGURE 6.  $V_{OUT1} = 1.5V$  REGULATION vs LOAD (200kHz)

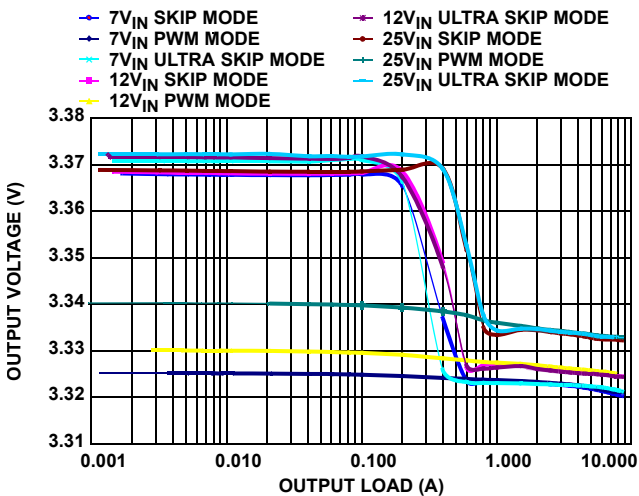

FIGURE 7.  $V_{OUT2} = 3.3V$  REGULATION vs LOAD (500kHz)

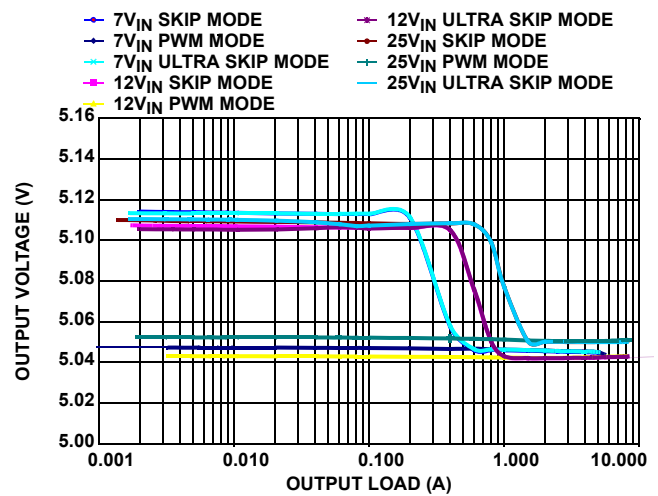

FIGURE 8.  $V_{OUT1} = 5V$  REGULATION vs LOAD (400kHz)

**Typical Performance Curves**

Circuit of Figures 66, 67 and 68, no load on LDO, OUT1, OUT2,  $V_{REF3}$ , and REF,  $V_{IN} = 12V$ ,  $EN2 = EN1 = VCC$ ,  $V_{BYP} = 5V$ ,  $PVCC = 5V$ ,  $V_{EN\_LDO} = 5V$ ,  $T_A = -40^{\circ}C$  to  $+100^{\circ}C$ , unless otherwise noted. Typical values are at  $T_A = +25^{\circ}C$ . (Continued)

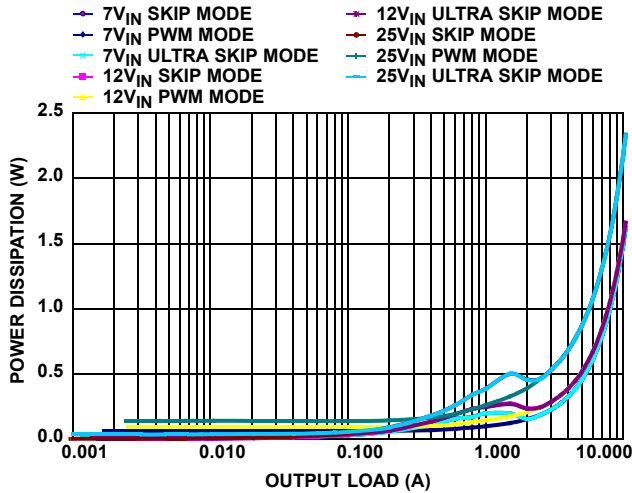

FIGURE 9.  $V_{OUT2} = 1.05V$  POWER DISSIPATION vs LOAD (300kHz)

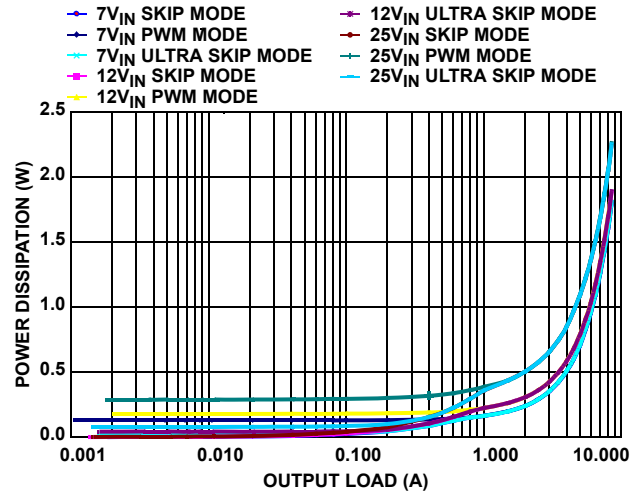

FIGURE 10.  $V_{OUT1} = 1.5V$  POWER DISSIPATION vs LOAD (200kHz)

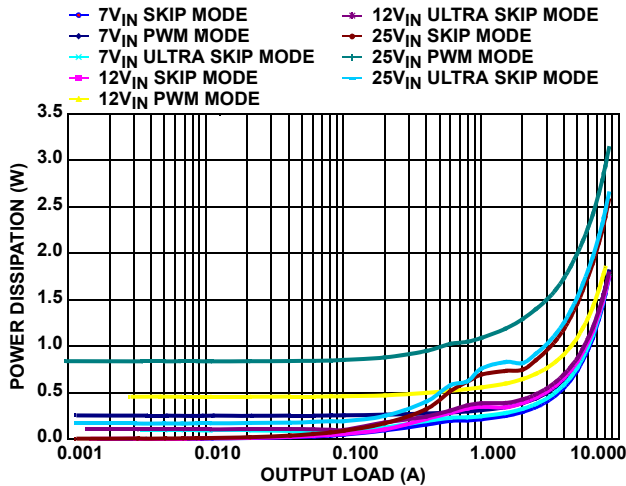

FIGURE 11.  $V_{OUT2} = 3.3V$  POWER DISSIPATION vs LOAD (500kHz)

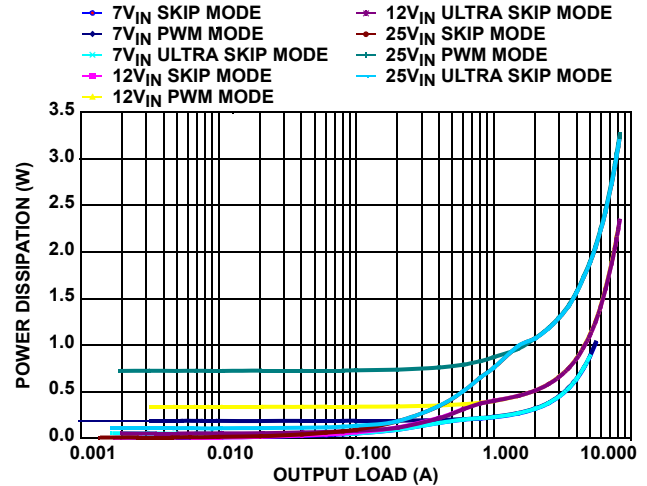

FIGURE 12.  $V_{OUT1} = 5V$  POWER DISSIPATION vs LOAD (400kHz)

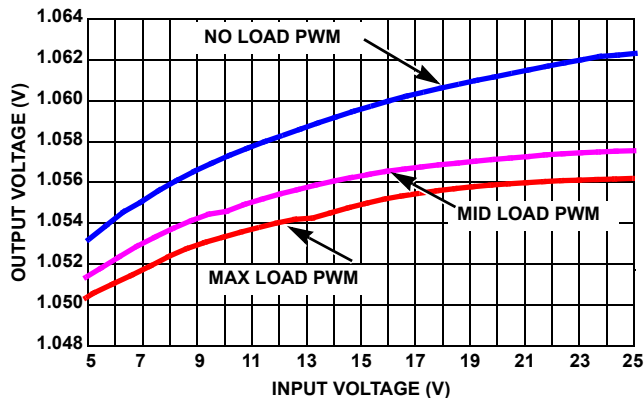

FIGURE 13.  $V_{OUT2} = 1.05V$  OUTPUT VOLTAGE REGULATION vs  $V_{IN}$  (PWM MODE)

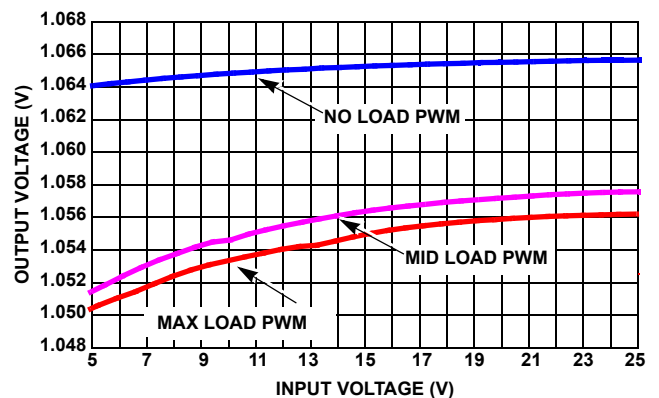

FIGURE 14.  $V_{OUT2} = 1.05V$  OUTPUT VOLTAGE REGULATION vs  $V_{IN}$  (SKIP MODE)

**Typical Performance Curves**

Circuit of Figures 66, 67 and 68, no load on LDO, OUT1, OUT2,  $V_{REF3}$ , and REF,  $V_{IN} = 12V$ ,  $EN2 = EN1 = VCC$ ,  $V_{BYP} = 5V$ ,  $PVCC = 5V$ ,  $V_{EN\_LDO} = 5V$ ,  $T_A = -40^{\circ}C$  to  $+100^{\circ}C$ , unless otherwise noted. Typical values are at  $T_A = +25^{\circ}C$ . (Continued)

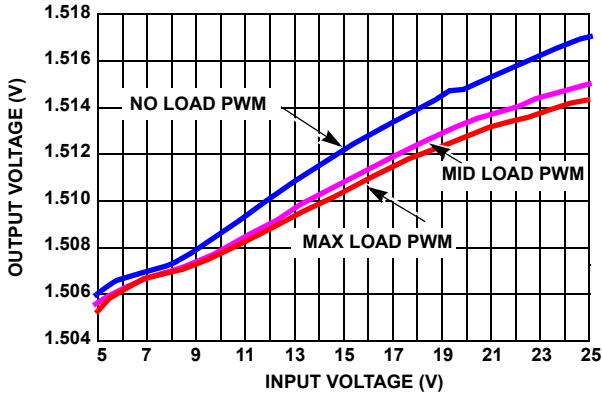

FIGURE 15.  $V_{OUT1} = 1.5V$  OUTPUT VOLTAGE REGULATION vs  $V_{IN}$  (PWM MODE)

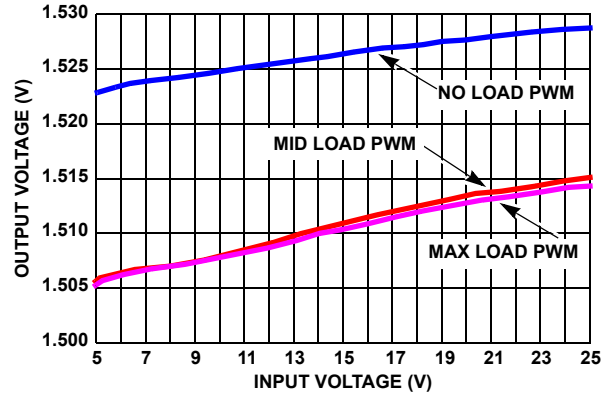

FIGURE 16.  $V_{OUT1} = 1.5V$  OUTPUT VOLTAGE REGULATION vs  $V_{IN}$  (SKIP MODE)

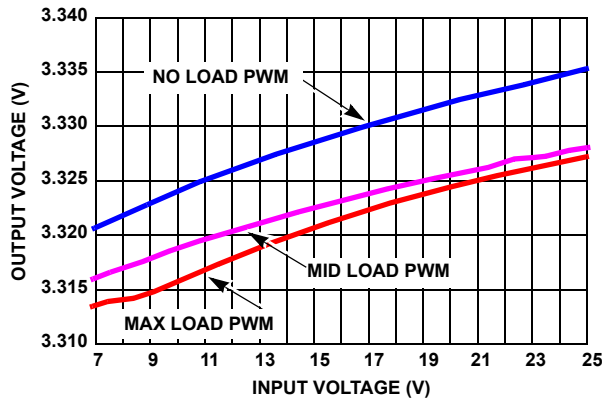

FIGURE 17.  $V_{OUT2} = 3.3V$  OUTPUT VOLTAGE REGULATION vs  $V_{IN}$  (PWM MODE)

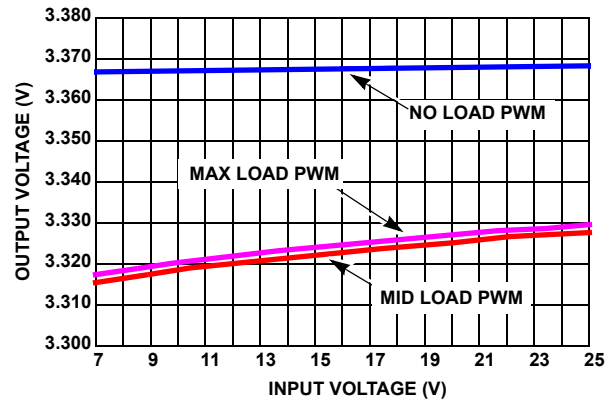

FIGURE 18.  $V_{OUT2} = 3.3V$  OUTPUT VOLTAGE REGULATION vs  $V_{IN}$  (SKIP MODE)

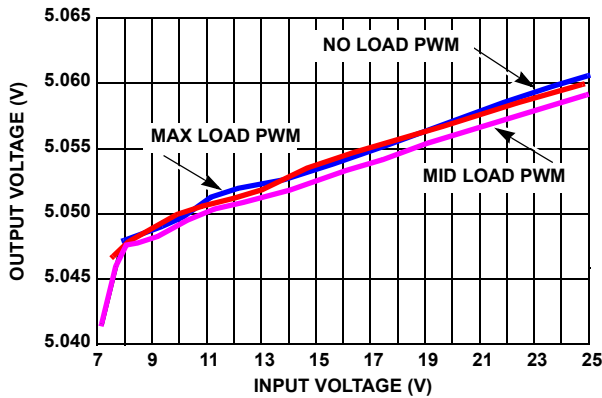

FIGURE 19.  $V_{OUT1} = 5V$  OUTPUT VOLTAGE REGULATION vs  $V_{IN}$  (PWM MODE)

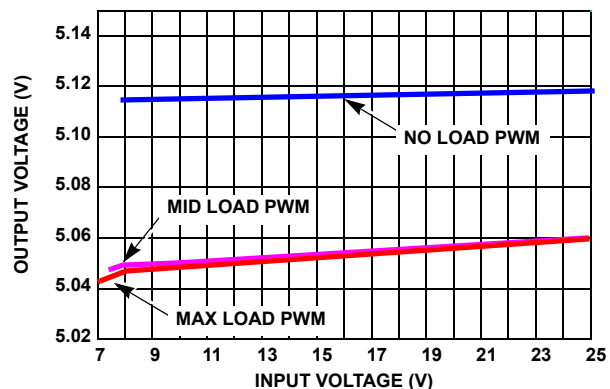

FIGURE 20.  $V_{OUT1} = 5V$  OUTPUT VOLTAGE REGULATION vs  $V_{IN}$  (SKIP MODE)

**Typical Performance Curves**

Circuit of Figures 66, 67 and 68, no load on LDO, OUT1, OUT2,  $V_{REF3}$ , and REF,  $V_{IN} = 12V$ ,  $EN2 = EN1 = VCC$ ,  $V_{BYP} = 5V$ ,  $PVCC = 5V$ ,  $V_{EN\_LDO} = 5V$ ,  $T_A = -40^{\circ}C$  to  $+100^{\circ}C$ , unless otherwise noted. Typical values are at  $T_A = +25^{\circ}C$ . (Continued)

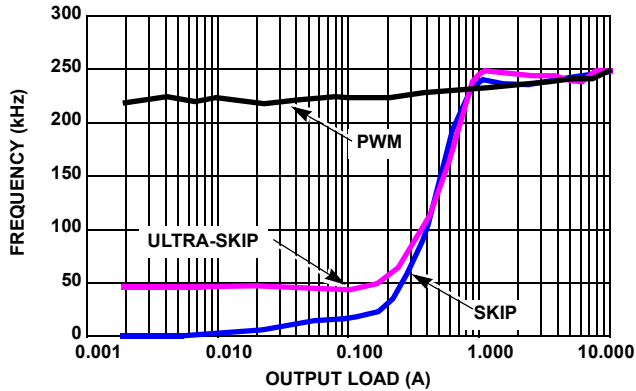

FIGURE 21.  $V_{OUT2} = 1.05V$  FREQUENCY vs LOAD

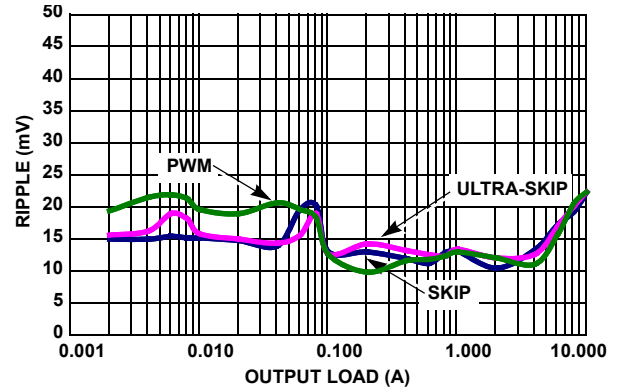

FIGURE 22.  $V_{OUT2} = 1.05V$  RIPPLE vs LOAD

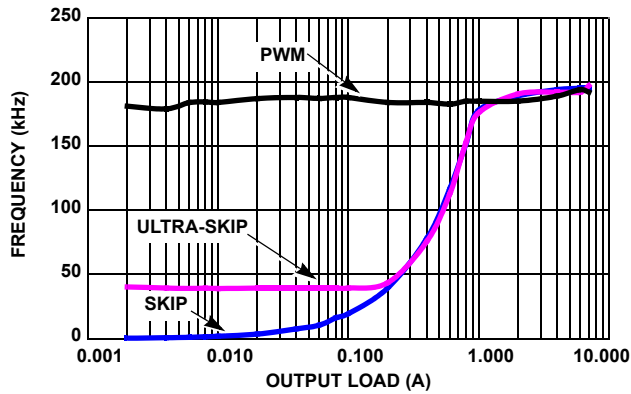

FIGURE 23.  $V_{OUT1} = 1.5V$  FREQUENCY vs LOAD

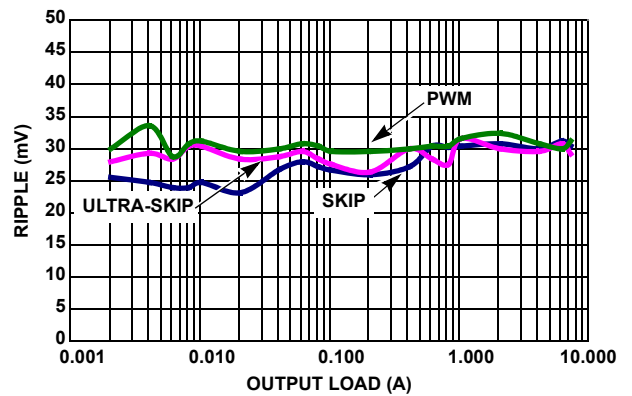

FIGURE 24.  $V_{OUT1} = 1.5V$  RIPPLE vs LOAD

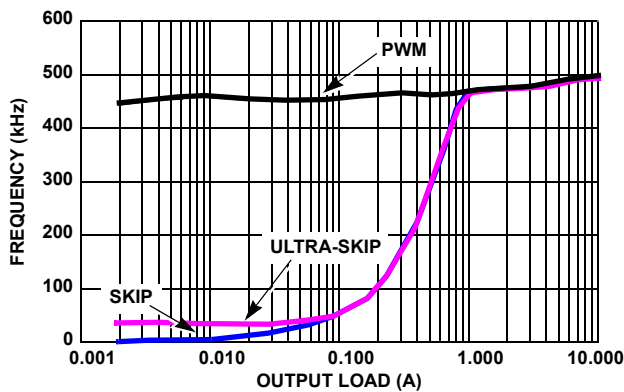

FIGURE 25.  $V_{OUT2} = 3.3V$  FREQUENCY vs LOAD

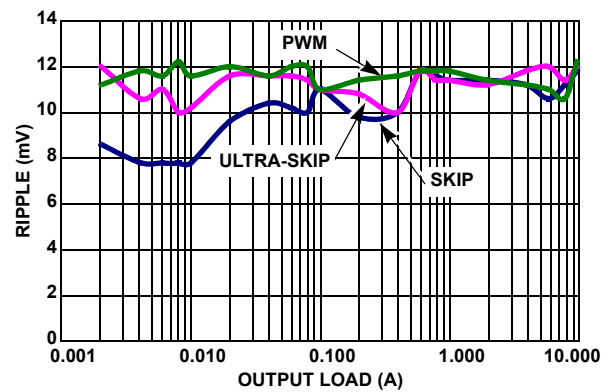

FIGURE 26.  $V_{OUT2} = 3.3V$  RIPPLE vs LOAD

**Typical Performance Curves**

Circuit of Figures 66, 67 and 68, no load on LDO, OUT1, OUT2,  $V_{REF3}$ , and REF,  $V_{IN} = 12V$ ,  $EN2 = EN1 = VCC$ ,  $V_{BYP} = 5V$ ,  $PVCC = 5V$ ,  $V_{EN\_LDO} = 5V$ ,  $T_A = -40^{\circ}C$  to  $+100^{\circ}C$ , unless otherwise noted. Typical values are at  $T_A = +25^{\circ}C$ . (Continued)

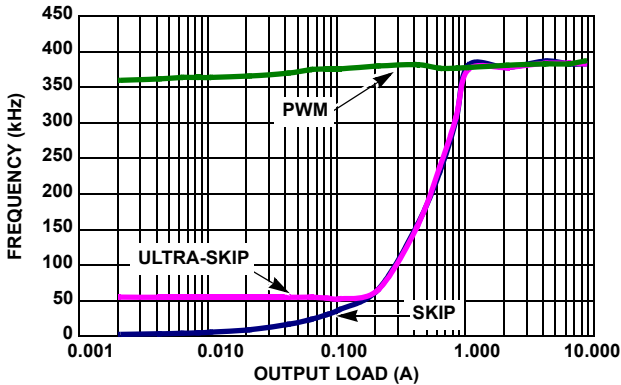

FIGURE 27.  $V_{OUT1} = 5V$  FREQUENCY vs LOAD

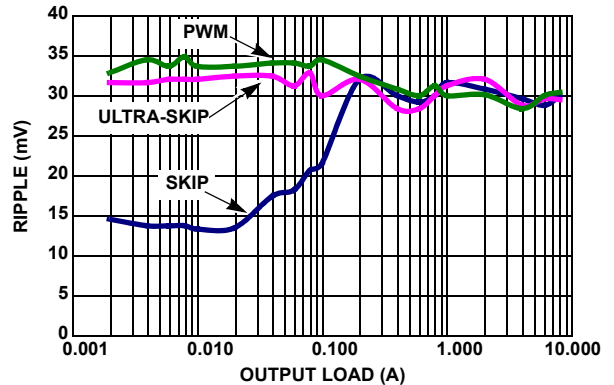

FIGURE 28.  $V_{OUT1} = 5V$  RIPPLE vs LOAD

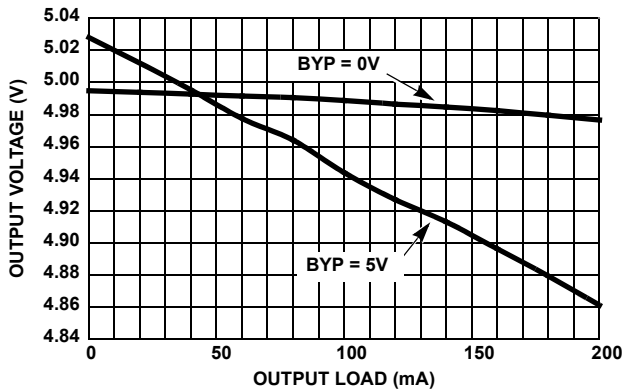

FIGURE 29. LDO OUTPUT 5V vs LOAD

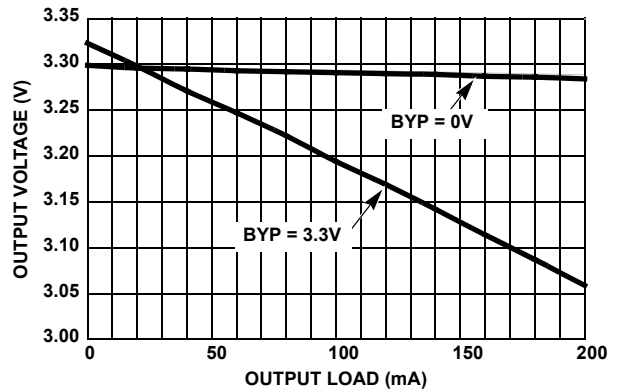

FIGURE 30. LDO OUTPUT 3.3V vs LOAD

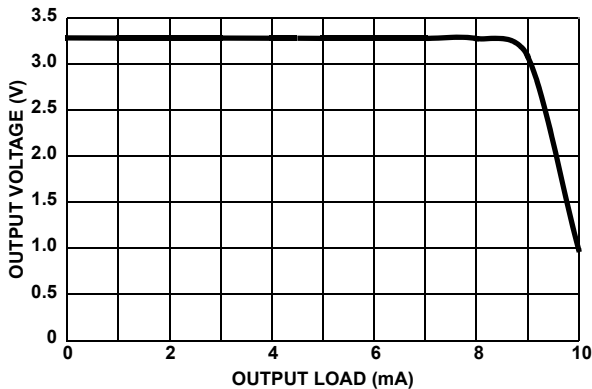

FIGURE 31.  $V_{REF3}$  vs LOAD

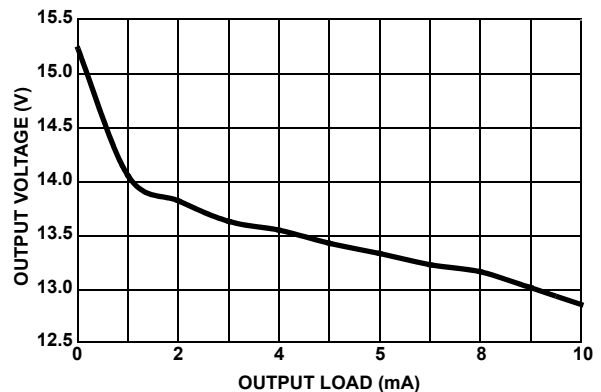

FIGURE 32. CHARGE PUMP vs LOAD (PWM)

**Typical Performance Curves**

Circuit of Figures 66, 67 and 68, no load on LDO, OUT1, OUT2,  $V_{REF3}$ , and REF,  $V_{IN} = 12V$ ,  $EN2 = EN1 = VCC$ ,  $V_{BYP} = 5V$ ,  $PVCC = 5V$ ,  $V_{EN\_LDO} = 5V$ ,  $T_A = -40^{\circ}C$  to  $+100^{\circ}C$ , unless otherwise noted. Typical values are at  $T_A = +25^{\circ}C$ . (Continued)

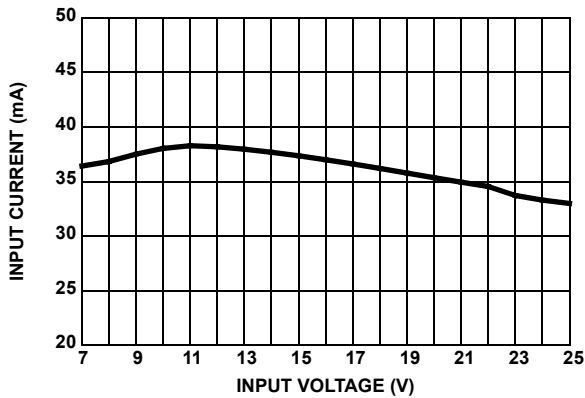

FIGURE 33. PWM NO LOAD INPUT CURRENT vs  $V_{IN}$   
( $EN = EN2 = EN\_LDO = VCC$ )

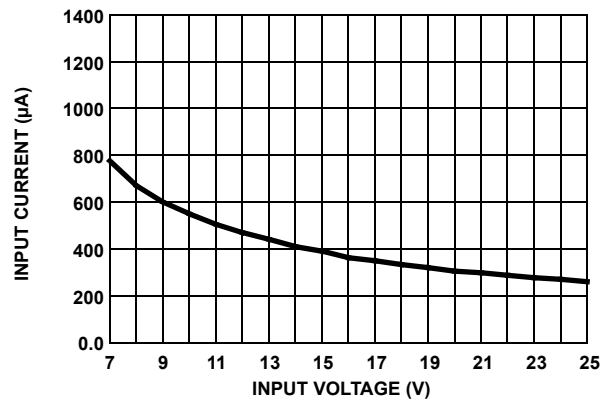

FIGURE 34. SKIP NO LOAD INPUT CURRENT vs  $V_{IN}$   
( $EN1 = EN2 = EN\_LDO = VCC$ )

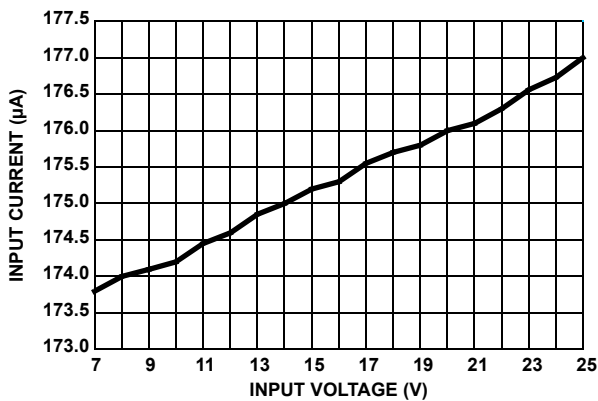

FIGURE 35. STANDBY INPUT CURRENT vs  $V_{IN}$   
( $EN = EN2 = 0, EN\_LDO = VCC$ )

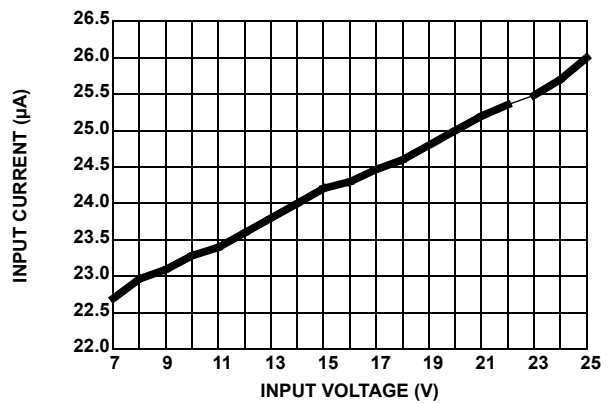

FIGURE 36. SHUTDOWN INPUT CURRENT vs  $V_{IN}$   
( $EN = EN2 = EN\_LDO = 0$ )

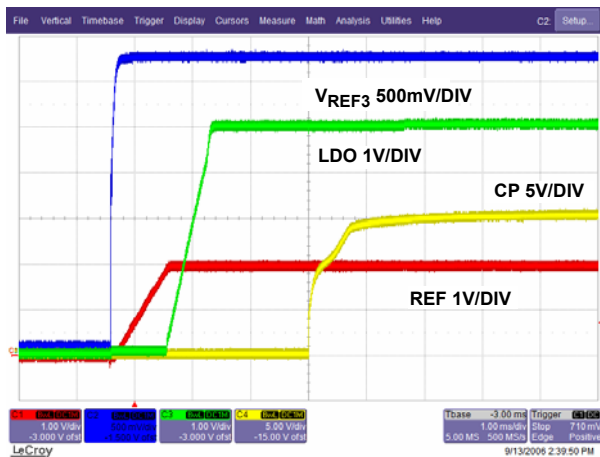

FIGURE 37. REF,  $V_{REF3}$ , LDO = 5V, CP, NO LOAD

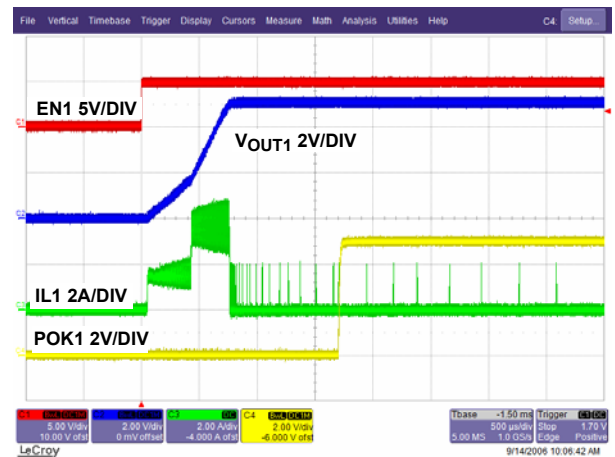

FIGURE 38. START-UP  $V_{OUT1} = 5V$  (NO LOAD, SKIP MODE)

**Typical Performance Curves**

Circuit of Figures 66, 67 and 68, no load on LDO, OUT1, OUT2,  $V_{REF3}$ , and REF,  $V_{IN} = 12V$ ,  $EN2 = EN1 = VCC$ ,  $V_{BYP} = 5V$ ,  $PVCC = 5V$ ,  $V_{EN\_LDO} = 5V$ ,  $T_A = -40^{\circ}C$  to  $+100^{\circ}C$ , unless otherwise noted. Typical values are at  $T_A = +25^{\circ}C$ . (Continued)

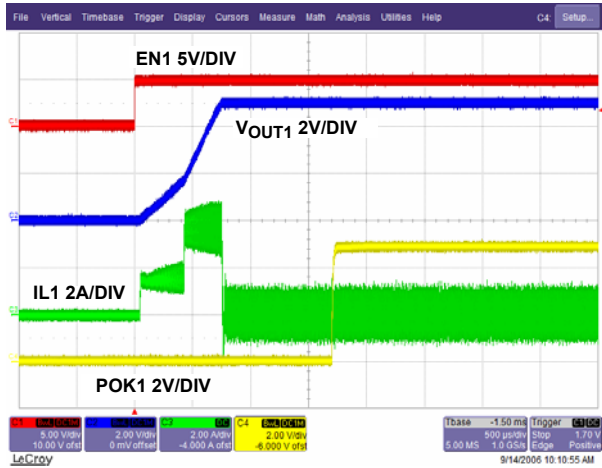

FIGURE 39. START-UP  $V_{OUT1} = 5V$  (NO LOAD, PWM MODE)

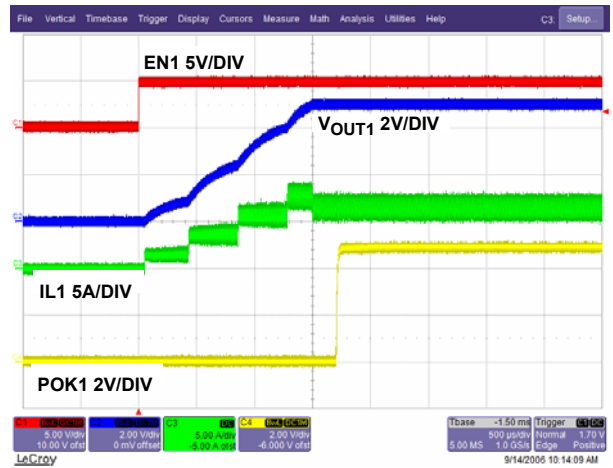

FIGURE 40. START-UP  $V_{OUT1} = 5V$  (FULL LOAD, PWM MODE)

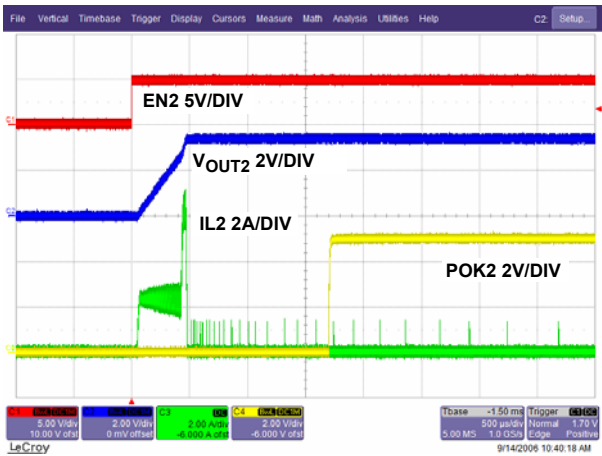

FIGURE 41. START-UP  $V_{OUT2} = 3.3V$  (NO LOAD, SKIP MODE)

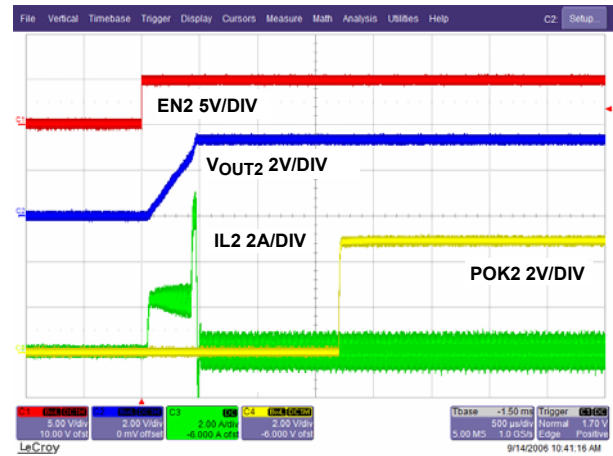

FIGURE 42. START-UP  $V_{OUT1} = 3.3V$  (NO LOAD, PWM MODE)

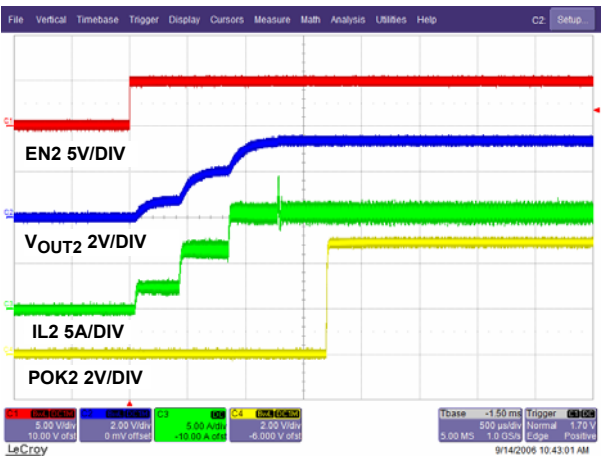

FIGURE 43. START-UP  $V_{OUT1} = 3.3V$  (FULL LOAD, PWM MODE)

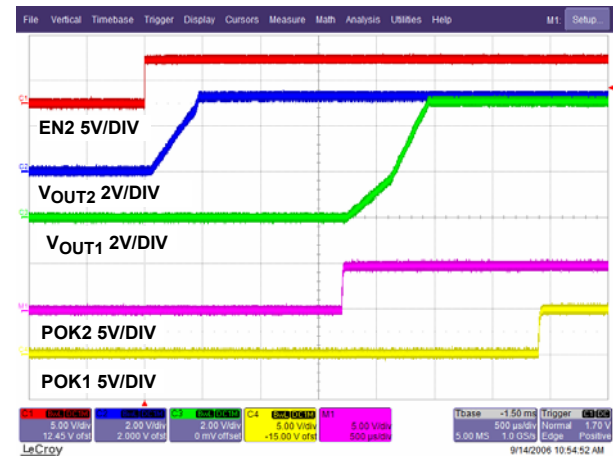

FIGURE 44. DELAYED START-UP ( $V_{OUT1} = 5V$ ,  $V_{OUT2} = 3.3V$ ,  $EN1 = REF$ )

**Typical Performance Curves**

Circuit of Figures 66, 67 and 68, no load on LDO, OUT1, OUT2,  $V_{REF3}$ , and REF,  $V_{IN} = 12V$ ,  $EN2 = EN1 = VCC$ ,  $V_{BYP} = 5V$ ,  $PVCC = 5V$ ,  $V_{EN\_LDO} = 5V$ ,  $T_A = -40^{\circ}C$  to  $+100^{\circ}C$ , unless otherwise noted. Typical values are at  $T_A = +25^{\circ}C$ . (Continued)

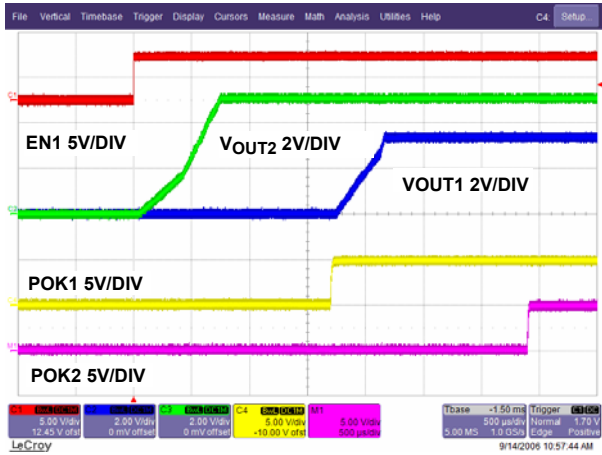

FIGURE 45. DELAYED START-UP ( $V_{OUT1} = 5V$ ,  $V_{OUT2} = 3.3V$ ,  $EN2 = REF$ )

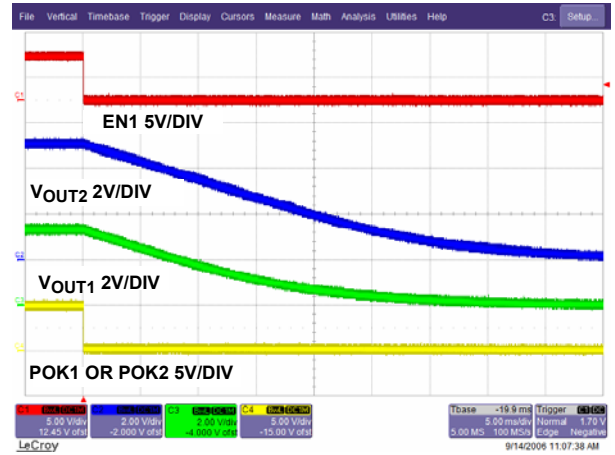

FIGURE 46. SHUTDOWN ( $V_{OUT1} = 5V$ ,  $V_{OUT2} = 3.3V$ ,  $EN2 = REF$ )

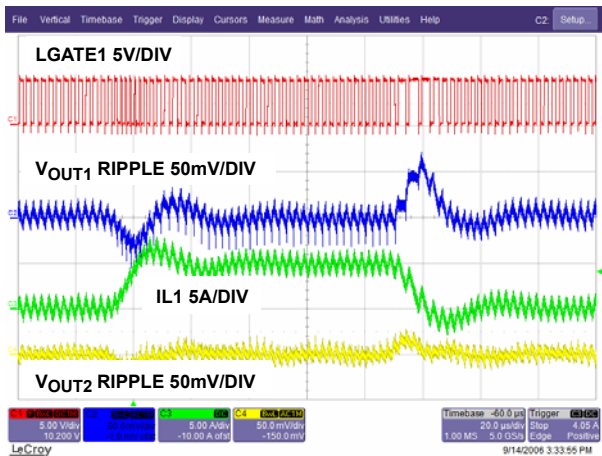

FIGURE 47. LOAD TRANSIENT  $V_{OUT1} = 5V$

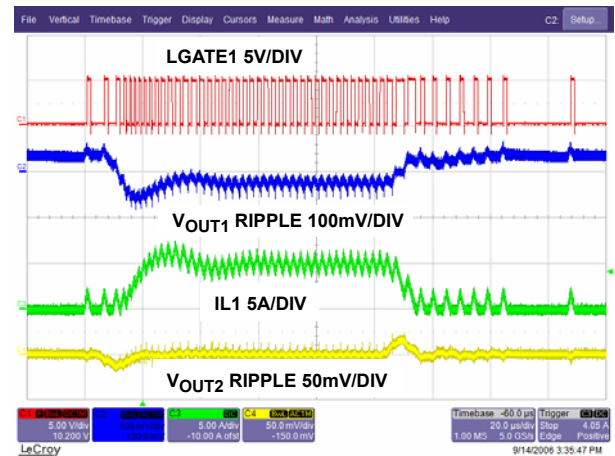

FIGURE 48. LOAD TRANSIENT  $V_{OUT1} = 5V$  (SKIP)

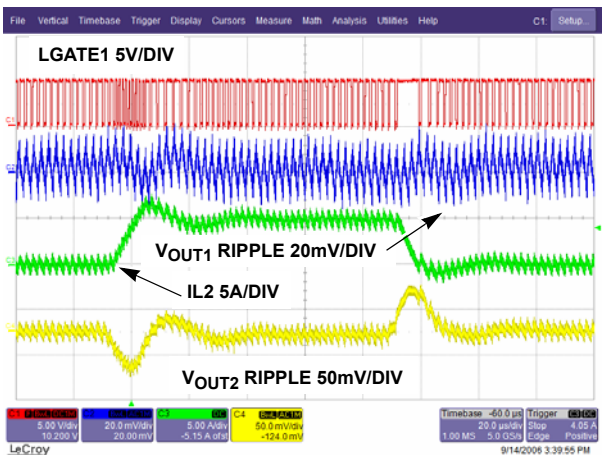

FIGURE 49. LOAD TRANSIENT  $V_{OUT1} = 3.3V$  (PWM)

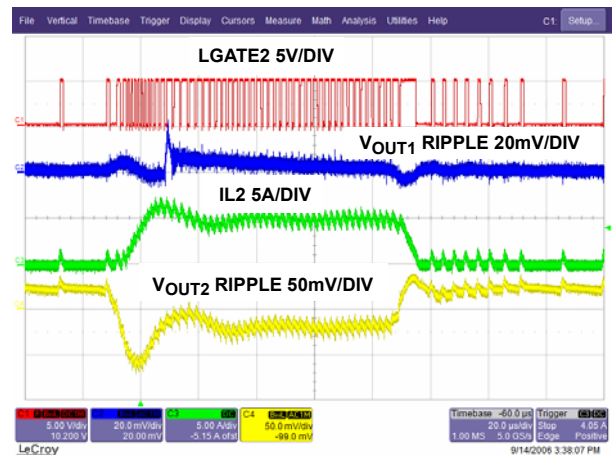

FIGURE 50. LOAD TRANSIENT  $V_{OUT1} = 3.3V$  (SKIP)



**Typical Performance Curves**

Circuit of Figures 66, 67 and 68, no load on LDO, OUT1, OUT2,  $V_{REF3}$ , and REF,  $V_{IN} = 12V$ ,  $EN2 = EN1 = VCC$ ,  $V_{BYP} = 5V$ ,  $PVCC = 5V$ ,  $V_{EN\_LDO} = 5V$ ,  $T_A = -40^{\circ}C$  to  $+100^{\circ}C$ , unless otherwise noted. Typical values are at  $T_A = +25^{\circ}C$ . (Continued)

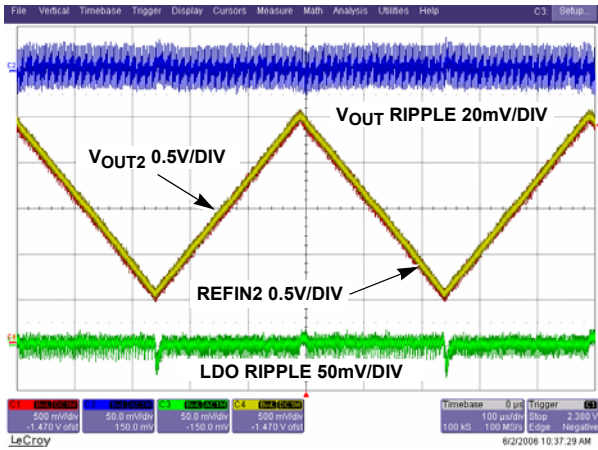

FIGURE 51.  $V_{OUT2}$  TRACKING TO REFIN2

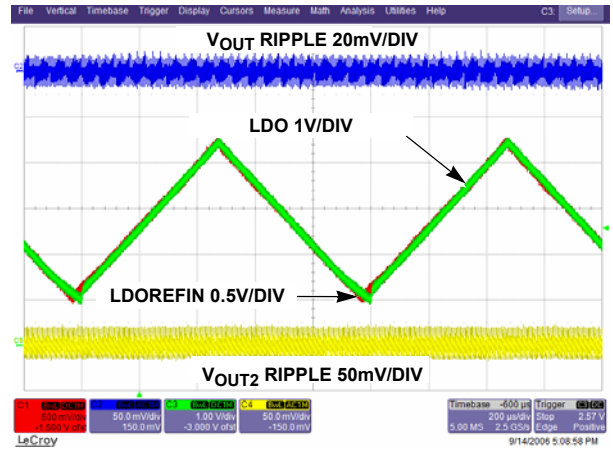

FIGURE 52. LDO TRACKING TO LDOREFIN

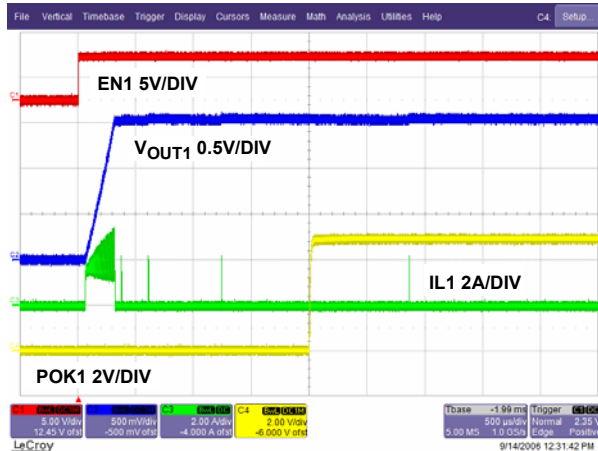

FIGURE 53. START-UP  $V_{OUT1} = 1.5V$  (NO LOAD, SKIP MODE)

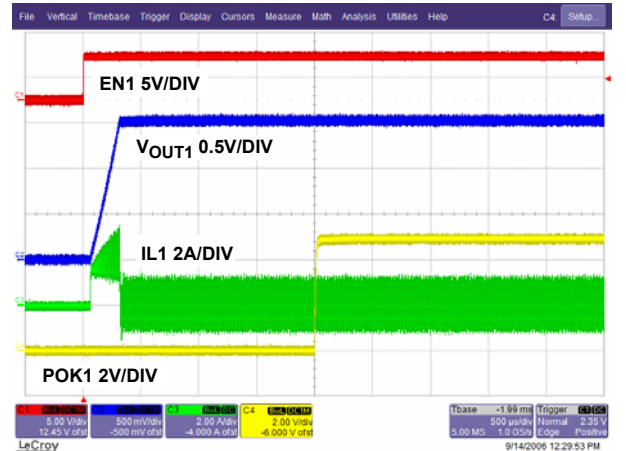

FIGURE 54. START-UP  $V_{OUT1} = 1.5V$  (NO LOAD, PWM MODE)

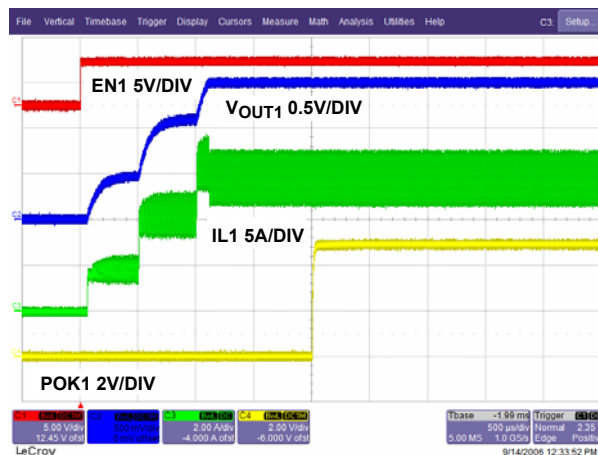

FIGURE 55. START-UP  $V_{OUT1} = 1.5V$  (FULL LOAD, PWM MODE)

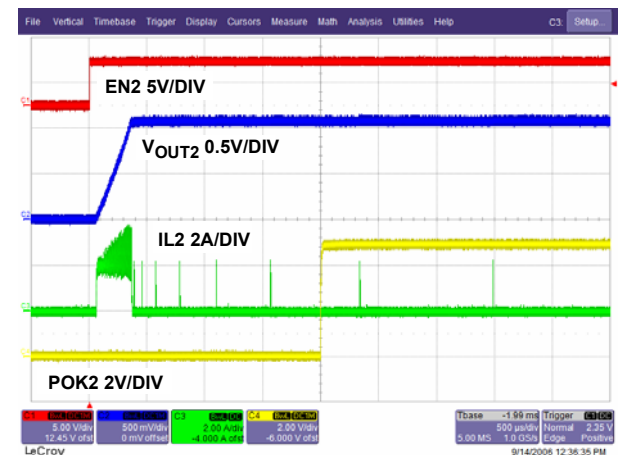

FIGURE 56. START-UP  $V_{OUT2} = 1.05V$  (NO LOAD, SKIP MODE)

**Typical Performance Curves**

Circuit of Figures 66, 67 and 68, no load on LDO, OUT1, OUT2,  $V_{REF3}$ , and REF,  $V_{IN} = 12V$ ,  $EN2 = EN1 = VCC$ ,  $V_{BYP} = 5V$ ,  $PVCC = 5V$ ,  $V_{EN\_LDO} = 5V$ ,  $T_A = -40^{\circ}C$  to  $+100^{\circ}C$ , unless otherwise noted. Typical values are at  $T_A = +25^{\circ}C$ . (Continued)

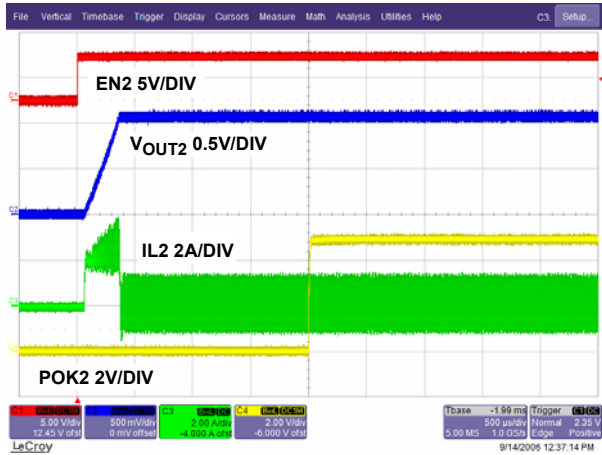

FIGURE 57. START-UP  $V_{OUT1} = 1.05V$  (NO LOAD, PWM MODE)

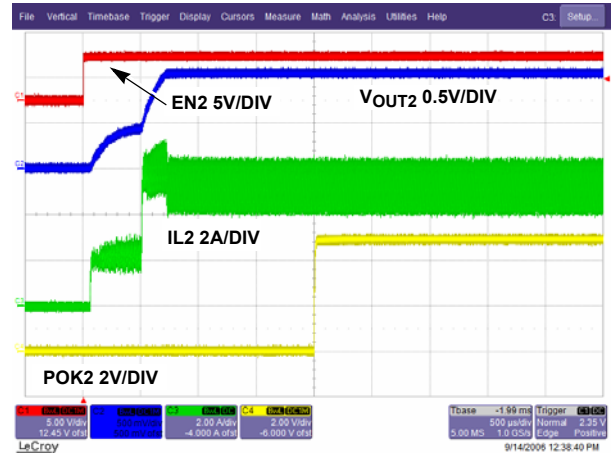

FIGURE 58. START-UP  $V_{OUT1} = 1.05V$  (FULL LOAD, PWM MODE)

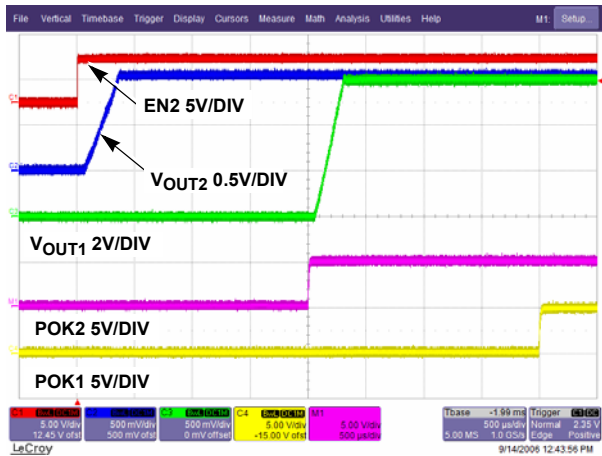

FIGURE 59. DELAYED START-UP ( $V_{OUT1} = 1.5V$ ,  $V_{OUT2} = 1.05V$ ,  $EN1 = REF$ )

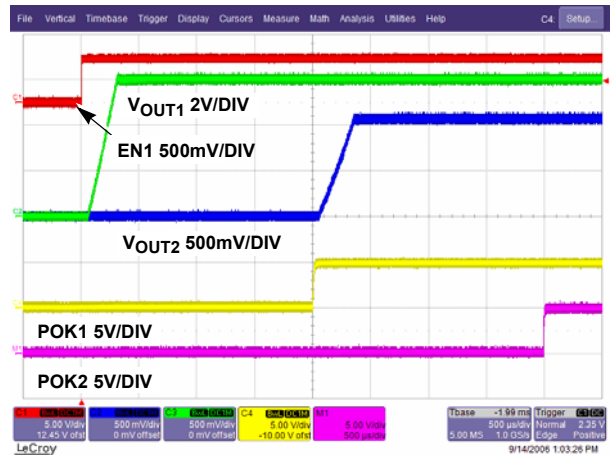

FIGURE 60. DELAYED START-UP ( $V_{OUT1} = 1.5V$ ,  $V_{OUT2} = 1.05V$ ,  $EN2 = REF$ )

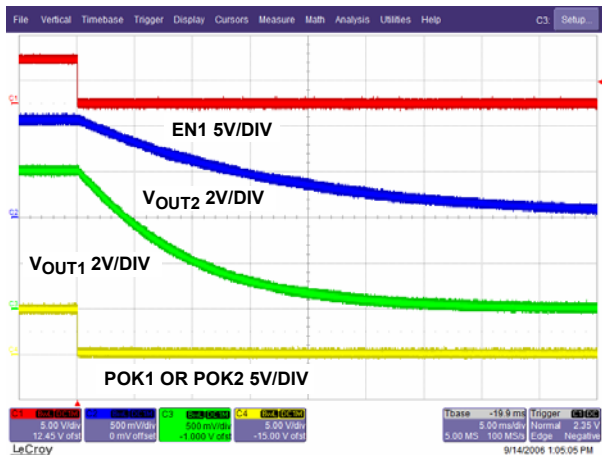

FIGURE 61. SHUTDOWN ( $V_{OUT1} = 1.5V$ ,  $V_{OUT2} = 1.05V$ ,  $EN2 = REF$ )

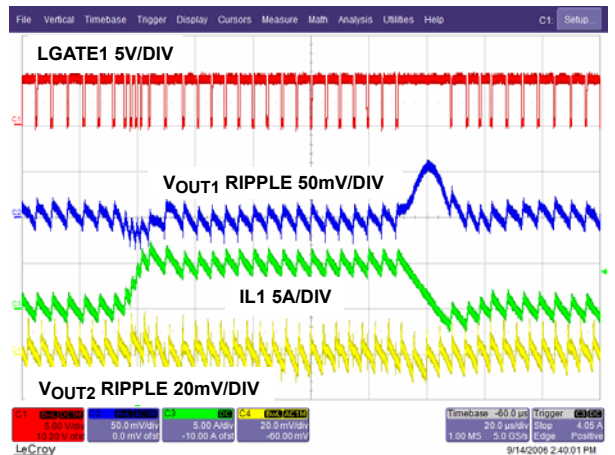

FIGURE 62. LOAD TRANSIENT  $V_{OUT1} = 1.5V$  (PWM)

## Typical Performance Curves

Circuit of Figures 66, 67 and 68, no load on LDO, OUT1, OUT2, V<sub>REF3</sub>, and REF, V<sub>IN</sub> = 12V, EN2 = EN1 = VCC, V<sub>BYP</sub> = 5V, PVCC = 5V, V<sub>EN\_LDO</sub> = 5V, T<sub>A</sub> = -40°C to +100°C, unless otherwise noted. Typical values are at T<sub>A</sub> = +25°C. (Continued)

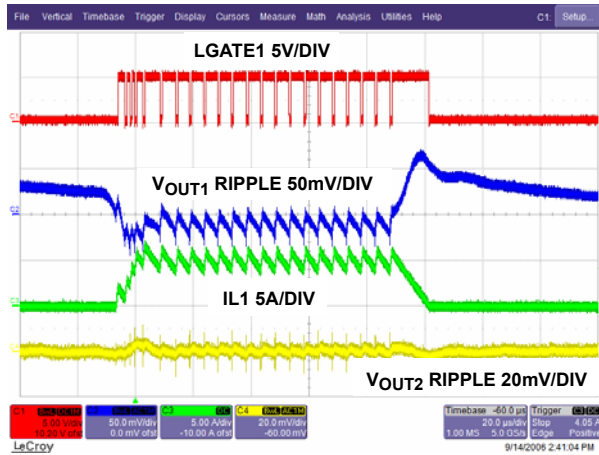

FIGURE 63. LOAD TRANSIENT V<sub>OUT1</sub> = 1.5V (SKIP)

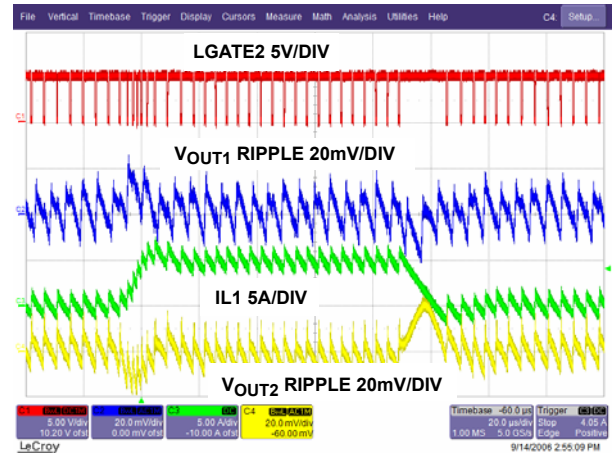

FIGURE 64. LOAD TRANSIENT V<sub>OUT1</sub> = 1.05V (PWM)

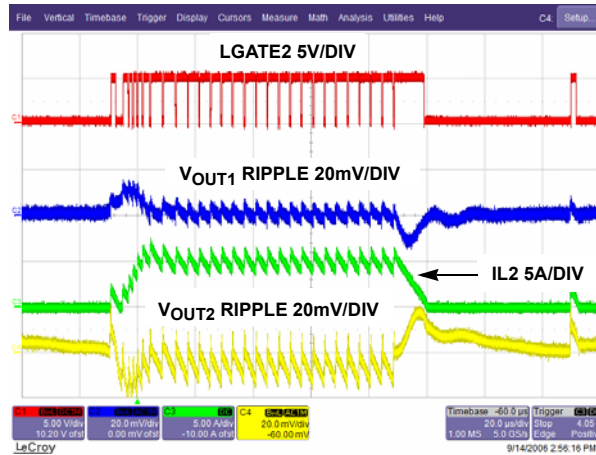

FIGURE 65. LOAD TRANSIENT V<sub>OUT1</sub> = 1.05V (SKIP)

## Typical Application Circuits

The typical application circuits (Figures 66, 67 and 68) generate the 5V/7A, 3.3V/11A, 1.25V/5A, dynamic voltage/10A, 1.5V/5A, 1.05V/5A and external 14V charge pump main supplies in a notebook computer. The ISL6236A is also equipped with a secondary feedback, SECFB, used to monitor the output of the 14V charge pump. In an event when the 14V drops below its threshold voltage, SECFB comparator will turn on LGATE1 for 300ns. This will refresh an external 14V charge pump without overcharging the output voltage. The input supply range is 5.5V to 25V.

## Detailed Description

The ISL6236A dual-buck, BiCMOS, switch-mode power supply controller generates logic supply voltages for notebook computers. The ISL6236A is designed primarily for battery-powered applications where high efficiency and low quiescent supply current are critical. The ISL6236A provides

a pin-selectable switching frequency, allowing operation for 200kHz/300kHz, 400kHz/300kHz, or 400kHz/500kHz on the SMPSs.

Light-load efficiency is enhanced by automatic Idle-Mode operation, a variable-frequency pulse-skipping mode that reduces transition and gate-charge losses. Each step-down, power-switching circuit consists of 2 N-Channel MOSFETs, a rectifier, and an LC output filter. The output voltage is the average AC voltage at the switching node, which is regulated by changing the duty cycle of the MOSFET switches. The gate-drive signal to the N-Channel high-side MOSFET must exceed the battery voltage, and is provided by a flying-capacitor boost circuit that uses a 100nF capacitor connected to BOOT.

Both SMPS1 and SMPS2 PWM controllers consist of a triple mode feedback network and multiplexer, a multi-input PWM comparator, high-side and low-side gate drivers and logic. In

addition, SMPS2 can also use REFIN2 to track its output from 0.5V to 2.50V. The ISL6236A contains fault-protection circuits that monitor the main PWM outputs for undervoltage and overvoltage conditions. A power-on sequence block controls the power-up timing of the main PWMs and monitors the outputs for undervoltage faults. The ISL6236A includes an adjustable low drop-out linear regulator. The bias generator blocks include the linear regulator, 3.3V precision reference, 2V precision reference and automatic bootstrap switchover circuit.

The synchronous-switch gate drivers are directly powered from PVCC, while the high-side switch gate drivers are indirectly powered from PVCC through an external capacitor and an internal Schottky diode boost circuit.

An automatic bootstrap circuit turns off the LDO linear regulator and powers the device from BYP if LDOREFIN is set to GND or VCC. See Table 1.

**TABLE 1. LDO OUTPUT VOLTAGE TABLE**

LDO VOLTAGE	CONDITIONS	COMMENT
VOLTAGE at BYP	LDOREFIN < 0.3V, BYP > 4.63V	Internal LDO is disabled.
VOLTAGE at BYP	LDOREFIN > VCC - 1V, BYP > 3V	Internal LDO is disabled.
5V	LDOREFIN < 0.3V, BYP < 4.63V	Internal LDO is active.
3.3V	LDOREFIN > VCC - 1V, BYP < 3V	Internal LDO is active.
2 x LDOREFIN	0.35V < LDOREFIN < 2.25V	Internal LDO is active.

### FREE-RUNNING, CONSTANT ON-TIME PWM CONTROLLER WITH INPUT FEED-FORWARD

The constant on-time PWM control architecture is a pseudo-fixed-frequency, constant on-time, current-mode type with voltage feed forward. The constant on-time PWM control architecture relies on the output ripple voltage to provide the PWM ramp signal; thus the output filter capacitor's ESR acts as a current-feedback resistor. The high-side switch on-time is determined by a one-shot whose period is inversely proportional to input voltage and directly proportional to output voltage. Another one-shot sets a minimum off-time (300ns typ). The on-time one-shot triggers when the following conditions are met: the error comparator's output is high, the synchronous rectifier current is below the current-limit threshold, and the minimum off time one-shot has timed out. The controller utilizes the valley point of the output ripple to regulate and determine the off-time.

### ON-TIME ONE-SHOT ( $t_{ON}$ )

Each PWM core includes a one-shot that sets the high-side switch on-time for each controller. Each fast, low-jitter, adjustable one-shot includes circuitry that varies the on-time in response to battery and output voltage. The high-side switch on-time is inversely proportional to the battery voltage as

measured by the VIN input and proportional to the output voltage. This algorithm results in a nearly constant switching frequency despite the lack of a fixed-frequency clock generator. The benefit of a constant switching frequency is that the frequency can be selected to avoid noise-sensitive frequency regions, as shown in Equation 1:

$$t_{ON} = \frac{K(V_{OUT} + I_{LOAD} \cdot r_{DS(ON)(LOWERQ)})}{V_{IN}} \quad (\text{EQ. 1})$$

See Table 2 for approximate K- factors. Switching frequency increases as a function of load current due to the increasing drop across the synchronous rectifier, which causes a faster inductor-current discharge ramp. On-times translate only roughly to switching frequencies. The on-times established in the "Electrical Specifications" table on page 4 are influenced by switching delays in the external high-side power MOSFET. Also, the dead-time effect increases the effective on-time, reducing the switching frequency. It occurs only in PWM mode ( $\overline{\text{SKIP}} = \text{VCC}$ ) and during dynamic output voltage transitions when the inductor current reverses at light or negative load currents. With reversed inductor current, the inductor's EMF causes PHASE to go high earlier than normal, extending the on-time by a period equal to the UGATE-rising dead time.

**TABLE 2. APPROXIMATE K-FACTOR ERRORS**

SMPS	SWITCHING FREQUENCY (kHz)	K-FACTOR ( $\mu\text{s}$ )	APPROXIMATE K-FACTOR ERROR (%)
( $t_{ON} = \text{GND, REF, or OPEN}$ ), VOUT1	400	2.5	$\pm 10$
( $t_{ON} = \text{GND}$ ), VOUT2	500	2.0	$\pm 10$
( $t_{ON} = \text{VCC}$ ), VOUT1	200	5.0	$\pm 10$
( $t_{ON} = \text{VCC, REF, or OPEN}$ ), VOUT2	300	3.3	$\pm 10$

For loads above the critical conduction point, the actual switching frequency is:

$$f = \frac{V_{OUT} + V_{DROPP1}}{t_{ON}(V_{IN} + V_{DROPP2})} \quad (\text{EQ. 2})$$

where:

- $V_{DROPP1}$  is the sum of the parasitic voltage drops in the inductor discharge path, including synchronous rectifier, inductor and PC board resistances
- $V_{DROPP2}$  is the sum of the parasitic voltage drops in the charging path, including high-side switch, inductor and PC board resistances
- $t_{ON}$  is the on-time calculated by the ISL6236A



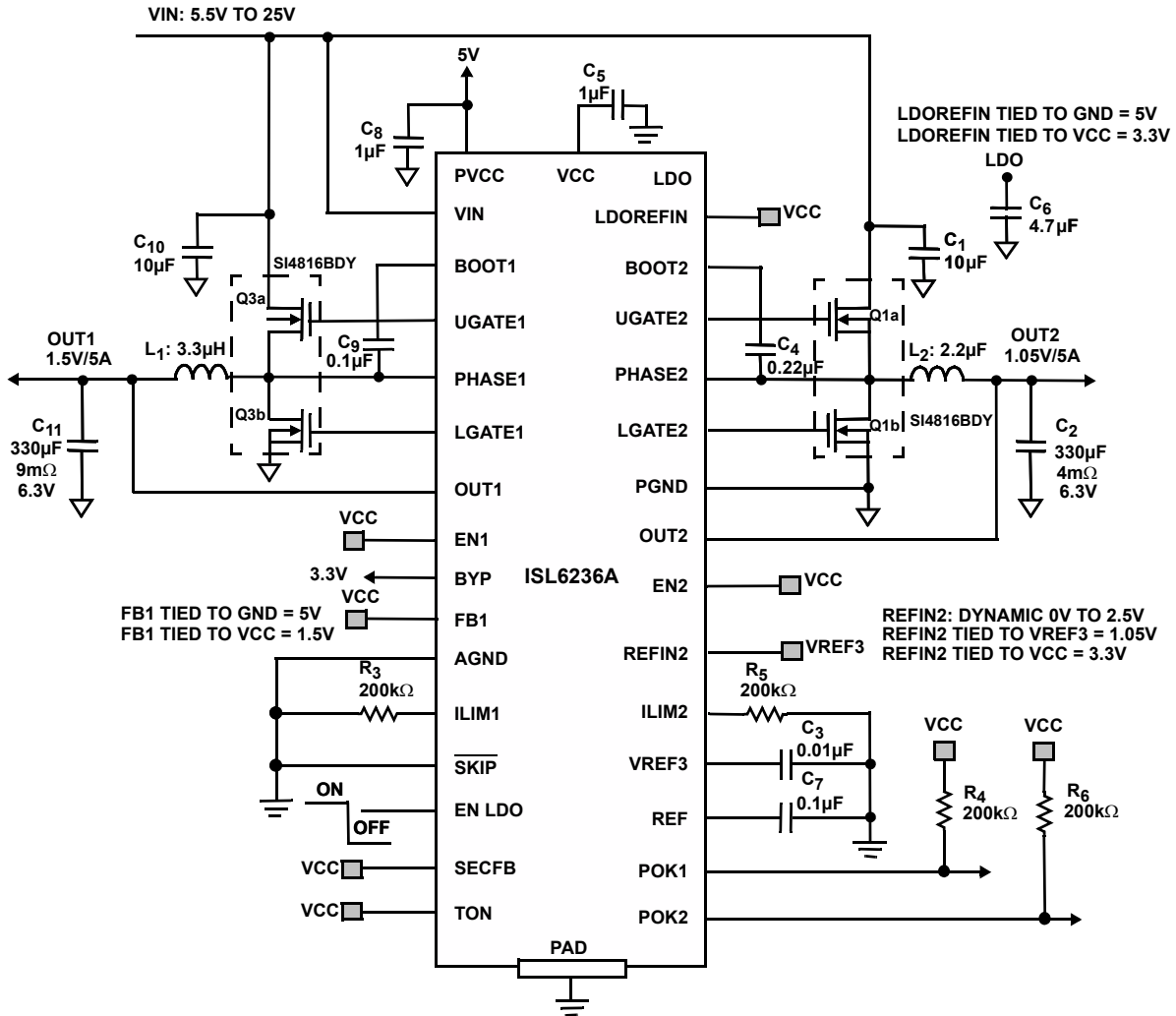

FREQUENCY-DEPENDENT COMPONENTS	
1.5V/1.05V SMPS SWITCHING FREQUENCY	$t_{ON} = VCC$
	200kHz/300kHz
L <sub>1</sub>	3.3µH
L <sub>2</sub>	2.7µH
C <sub>2</sub>	330µF
C <sub>11</sub>	330µF

FIGURE 67. ISL6236A TYPICAL SYSTEM REGULATOR APPLICATION CIRCUIT WITHOUT CHARGE PUMP

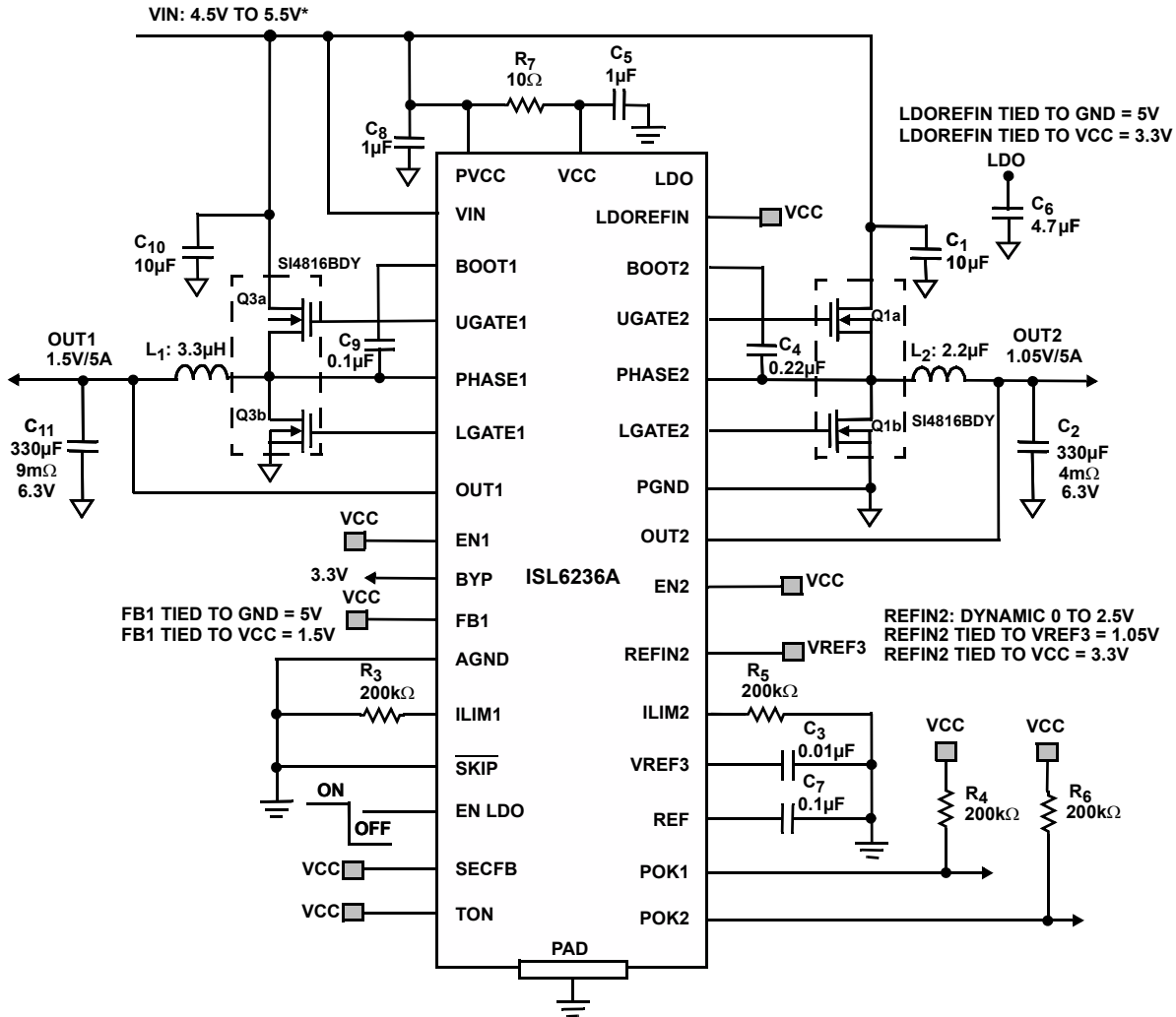

\*NOTE: To prevent noise in high loading conditions, place a 10Ω resistor between VIN and PVCC. Additional electrolytic bulk decoupling can also be used for this purpose

FREQUENCY-DEPENDENT COMPONENTS	
1.5V/1.05V SMPS SWITCHING FREQUENCY	$t_{ON} = VCC$
	200kHz/300kHz
L <sub>1</sub>	3.3µH
L <sub>2</sub>	2.7µH
C <sub>2</sub>	330µF
C <sub>11</sub>	330µF

FIGURE 68. ISL6236A TYPICAL LOW INPUT VOLTAGE SYSTEM REGULATOR APPLICATION CIRCUIT WITHOUT CHARGE PUMP

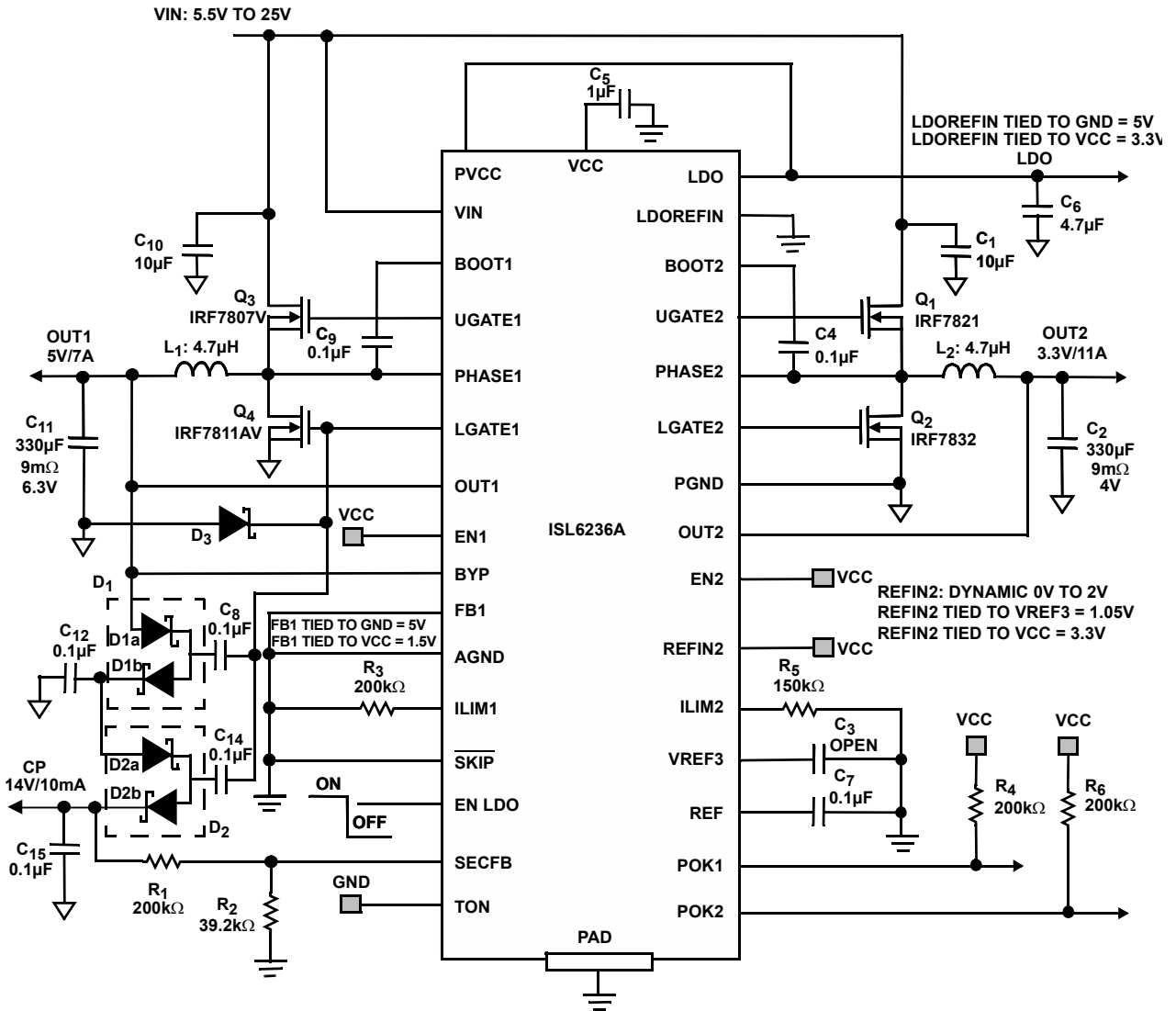

FREQUENCY-DEPENDENT COMPONENTS			
5V/3.3V SMPS SWITCHING FREQUENCY	$t_{ON} = VCC$	$t_{ON} = REF$ (OR OPEN)	$t_{ON} = GND$
	200kHz/300kHz	400kHz/300kHz	400kHz/500kHz
L <sub>1</sub>	6.8μH	6.8μH	4.7μH
L <sub>2</sub>	7.6μH	4.7μH	4.7μH
C <sub>2</sub>	2x470μF	2x330μF	2x330μF
C <sub>11</sub>	330μF	330μF	330μF

FIGURE 69. ISL6236A TYPICAL SYSTEM REGULATOR APPLICATION CIRCUIT WITH 14V CHARGE PUMP



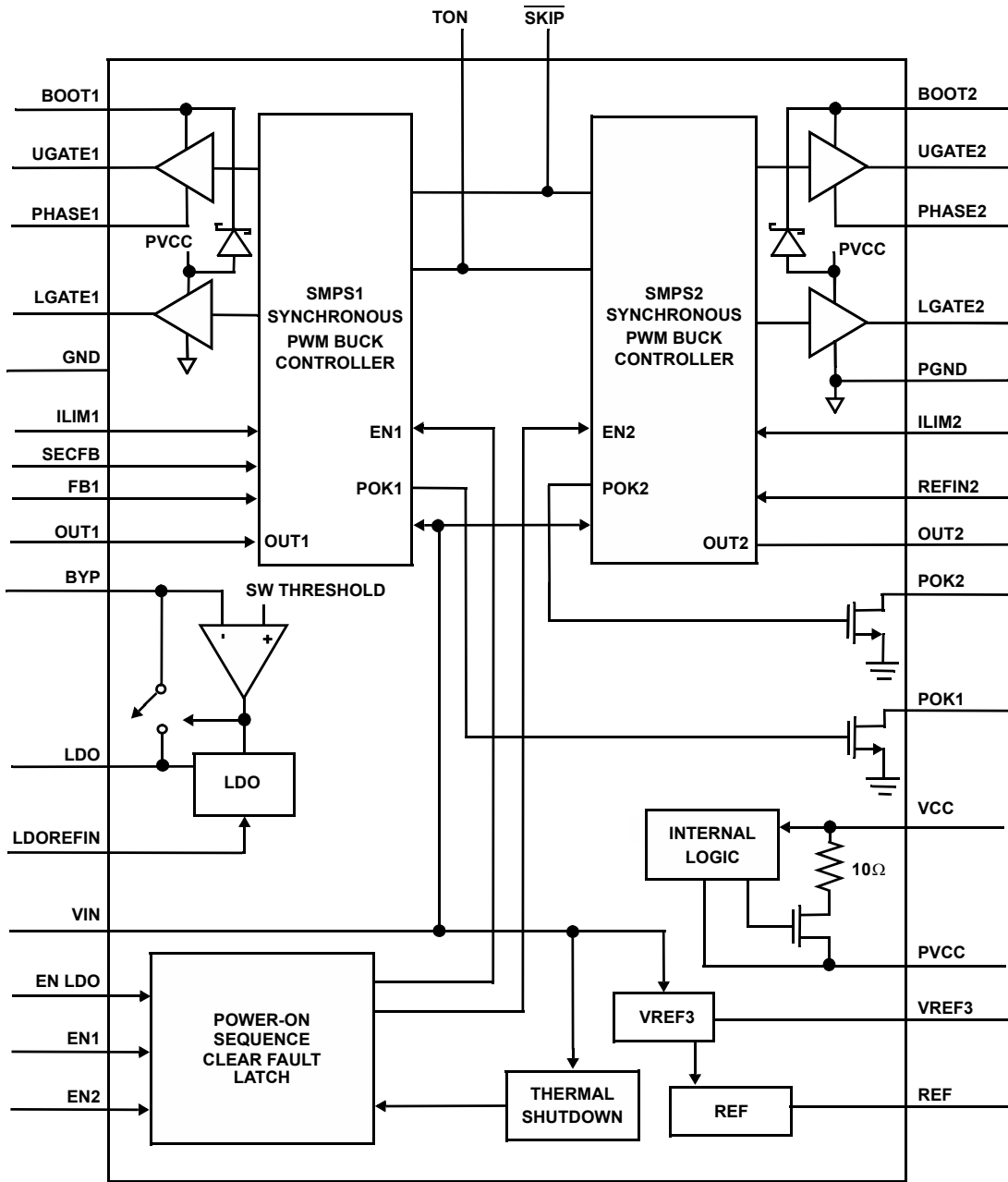

FIGURE 70. DETAILED FUNCTIONAL DIAGRAM ISL6236A

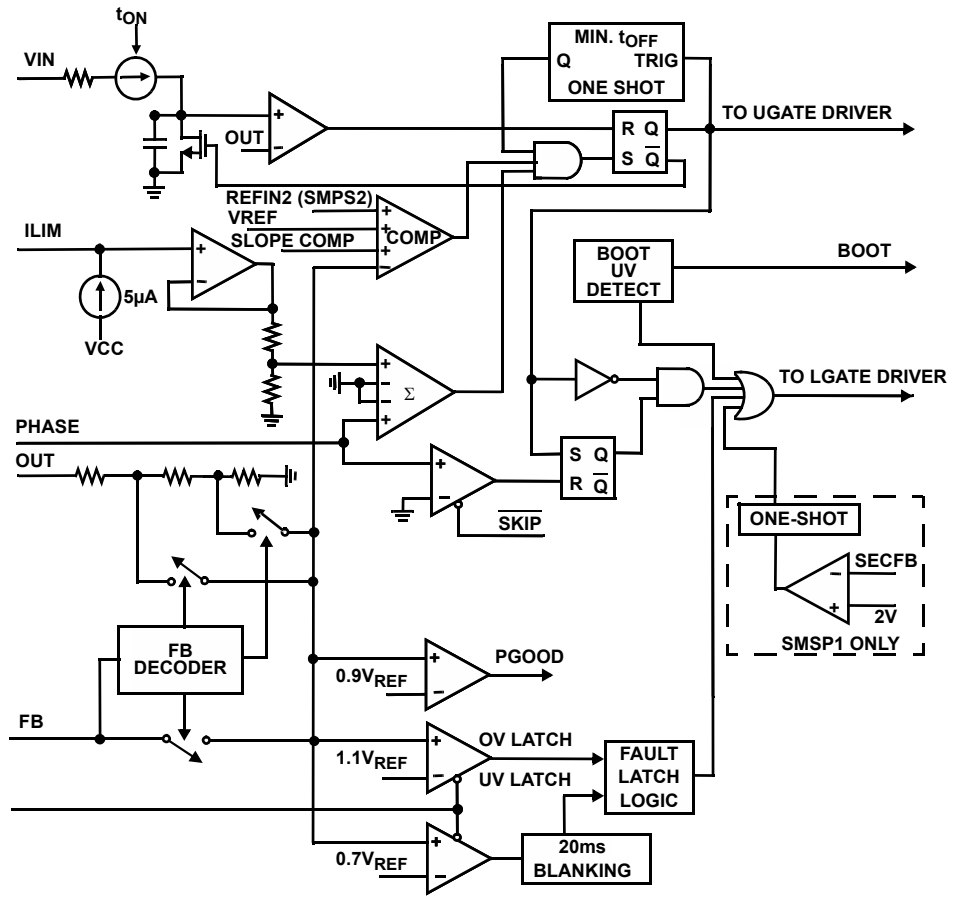

FIGURE 71. PWM CONTROLLER (ONE SIDE ONLY)

## Automatic Pulse-Skipping Switchover (Idle Mode)

In Idle Mode ( $\overline{\text{SKIP}} = \text{GND}$ ), an inherent automatic switchover to PFM takes place at light loads. This switchover is affected by a comparator that truncates the low-side switch on-time at the inductor current's zero crossing. This mechanism causes the threshold between pulse-skipping PFM and nonskipping PWM operation to coincide with the boundary between continuous and discontinuous inductor-current operation (also known as the critical conduction point):

$$I_{\text{LOAD(SKIP)}} = \frac{K \cdot V_{\text{OUT}} V_{\text{IN}} - V_{\text{OUT}}}{2 \cdot L \cdot V_{\text{IN}}} \quad (\text{EQ. 3})$$

where K is the on-time scale factor (see "ON-TIME ONE-SHOT ( $t_{\text{ON}}$ )" on page 20). The load-current level at which PFM/PWM crossover occurs,  $I_{\text{LOAD(SKIP)}}$ , is equal to half the peak-to-peak ripple current, which is a function of the inductor value (Figure 72). For example, in the ISL6236A typical application circuit with  $V_{\text{OUT1}} = 5\text{V}$ ,  $V_{\text{IN}} = 12\text{V}$ ,  $L = 7.6\mu\text{H}$ , and  $K = 5\mu\text{s}$ , switchover to pulse-skipping operation occurs at  $I_{\text{LOAD}} = 0.96\text{A}$  or about on-fifth full load. The crossover point occurs at an even lower value if a swinging (soft-saturation) inductor is used.

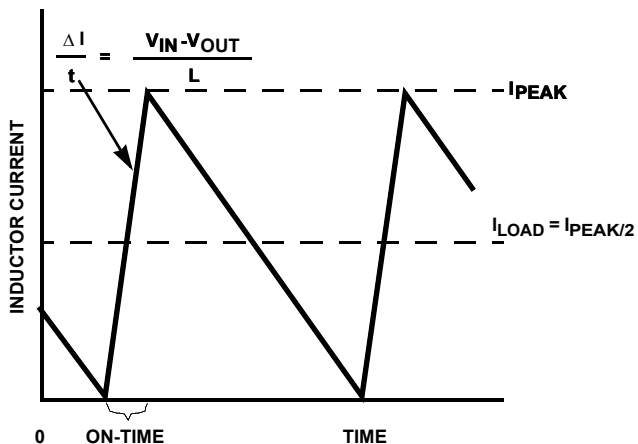

FIGURE 72. ULTRASONIC CURRENT WAVEFORMS

The switching waveforms may appear noisy and asynchronous when light loading causes pulse-skipping operation, but this is a normal operating condition that results in high light-load efficiency. Trade-offs in PFM noise vs light-load efficiency are made by varying the inductor value. Generally, low inductor values produce a broader efficiency vs load curve, while higher values result in higher full-load efficiency (assuming that the coil resistance remains fixed) and less output voltage ripple. Penalties for using higher inductor values include larger physical size and degraded load-transient response (especially at low input-voltage levels).

DC output accuracy specifications refer to the trip level of the error comparator. When the inductor is in continuous conduction, the output voltage has a DC regulation higher than the trip level by 50% of the ripple. In discontinuous conduction

( $\overline{\text{SKIP}} = \text{GND}$ , light load), the output voltage has a DC regulation higher than the trip level by approximately 1.0% due to slope compensation.

## Forced-PWM Mode

The low-noise, forced-PWM ( $\overline{\text{SKIP}} = \text{VCC}$ ) mode disables the zero-crossing comparator, which controls the low-side switch on-time. Disabling the zero-crossing detector causes the low-side, gate-drive waveform to become the complement of the high-side, gate-drive waveform. The inductor current reverses at light loads as the PWM loop strives to maintain a duty ratio of  $V_{\text{OUT}}/V_{\text{IN}}$ . The benefit of forced-PWM mode is to keep the switching frequency fairly constant, but it comes at a cost: the no-load battery current can be 10mA to 50mA, depending on switching frequency and the external MOSFETs.

Forced-PWM mode is most useful for reducing audio-frequency noise, improving load-transient response, providing sink-current capability for dynamic output voltage adjustment, and improving the cross-regulation of multiple-output applications that use a flyback transformer or coupled inductor.

## Enhanced Ultrasonic Mode (25kHz (min) Pulse Skipping)

Leaving  $\overline{\text{SKIP}}$  unconnected or connecting  $\overline{\text{SKIP}}$  to REF activates a unique pulse-skipping mode with a minimum switching frequency of 25kHz. This ultrasonic pulse-skipping mode eliminates audio-frequency modulation that would otherwise be present when a lightly loaded controller automatically skips pulses. In ultrasonic mode, the controller automatically transitions to fixed-frequency PWM operation when the load reaches the same critical conduction point ( $I_{\text{LOAD(SKIP)}}$ ).

An ultrasonic pulse occurs when the controller detects that no switching has occurred within the last 20 $\mu\text{s}$ . Once triggered, the ultrasonic controller pulls LGATE high, turning on the low-side MOSFET to induce a negative inductor current. After FB drops below the regulation point, the controller turns off the low-side MOSFET (LGATE pulled low) and triggers a constant on-time (UGATE driven high). When the on-time has expired, the controller re-enables the low-side MOSFET until the controller detects that the inductor current dropped below the zero-crossing threshold. Starting with a LGATE pulse greatly reduces the peak output voltage when compared to starting with a UGATE pulse, as long as  $V_{\text{FB}} < V_{\text{REF}}$ , LGATE is off and UGATE is on, similar to pure SKIP mode.

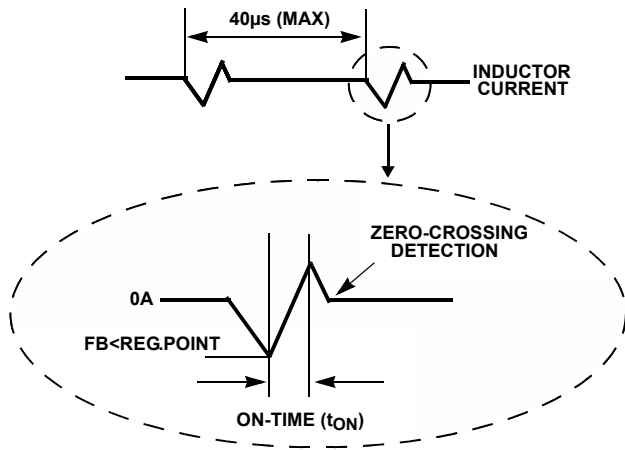

FIGURE 73. ULTRASONIC CURRENT WAVEFORMS

**Reference and Linear Regulators (VREF3, REF, LDO and 14V Charge Pump)**

The 3.3V reference (VREF3) is accurate to ±1.5% over-temperature, making VREF3 useful as a precision system reference. VREF3 can supply up to 5mA for external loads. Bypass VREF3 to GND with a 0.01µF capacitor. Leave it open if there is no load.

The 2V reference (REF) is accurate to ±1% over- temperature, also making REF useful as a precision system reference. Bypass REF to GND with a 0.1µF (min) capacitor. REF can supply up to 50µA for external loads.

An internal regulator produces a fixed 5V (LDOREFIN < 0.2V) or 3.3V (LDOREFIN > VCC - 1V). In an adjustable mode, the LDO output can be set from 0.7V to 4.5V. The LDO output voltage is equal to two times the LDOREFIN voltage. The LDO regulator can supply up to 100mA for external loads. Bypass LDO with a minimum 4.7µF ceramic capacitor. When the LDOREFIN < 0.2V and BYP voltage is 5V, the LDO bootstrap-switchover to an internal 0.7Ω P-Channel MOSFET switch connects BYP to LDO pin while simultaneously shutting down the internal linear regulator. These actions bootstrap the device, powering the loads from the BYP input voltages, rather than through internal linear regulators from the battery. Similarly, when the BYP = 3.3V and LDOREFIN = VCC, the LDO bootstrap-switchover to an internal 1.5Ω P-Channel MOSFET switch connects BYP to LDO pin while simultaneously shutting down the internal linear regulator. No switchover action in adjustable mode.

In Figure 68, the external 14V charge pump is driven by LGATE1. When LGATE1 is low, D1a charged C8 sourced from OUT1. C8 voltage is equal to OUT1 minus a diode drop. When LGATE1 transitions to high, the charges from C8 will transfer to C12 through D1b and charge it to VLGATE1 plus VC8. As LGATE1 transitions low on the next cycle, C12 will charge C14 to its voltage minus a diode drop through D2a. Finally, C14

charges C15 thru D2b when LGATE1 switched to high. CP output voltage is shown in Equation 4:

$$CP = V_{OUT1} + 2 \cdot V_{LGATE1} - 4 \cdot V_D \tag{EQ. 4}$$

where:

- V<sub>LGATE1</sub> is the peak voltage of the LGATE1 driver
- V<sub>D</sub> is the forward diode dropped across the Schottkys

SECFB is used to monitor the charge pump through the resistive divider. In an event when SECFB dropped below 2V, the detection circuit force the highside MOSFET (SMPS1) off and the lowside MOSFET (SMPS1) on for 300ns to allow CP to recharge and SECFB rise above 2V. In the event of an overload on CP where SECFB cannot reach more than 2V, the monitor will be deactivated. Special care should be taken to ensure enough normal voltage ripple on each cycle as to prevent CP shut-down. The SECFB pin has ~17mV of hysteresis, so the ripple should be enough to bring the SECFB voltage above the threshold by ~3x the hysteresis, or (2V + 3\*17mV) = 2.051V. Reducing the CP decoupling capacitor and placing a small ceramic capacitor (10pF to 47pF) in parallel with the upper leg of the SECFB resistor feedback network (R<sub>1</sub> of Figure 68), will also increase the robustness of the charge pump.

**Current-Limit Circuit (ILIM ) with r<sub>DS(ON)</sub> Temperature Compensation**

The current-limit circuit employs a "valley" current-sensing algorithm. The ISL6236A uses the ON-resistance of the synchronous rectifier as a current-sensing element. If the magnitude of the current-sense signal at PHASE is above the current-limit threshold, the PWM is not allowed to initiate a new cycle. The actual peak current is greater than the current-limit threshold by an amount equal to the inductor ripple current. Therefore, the exact current-limit characteristic and maximum load capability are a function of the current-limit threshold, inductor value and input and output voltage.

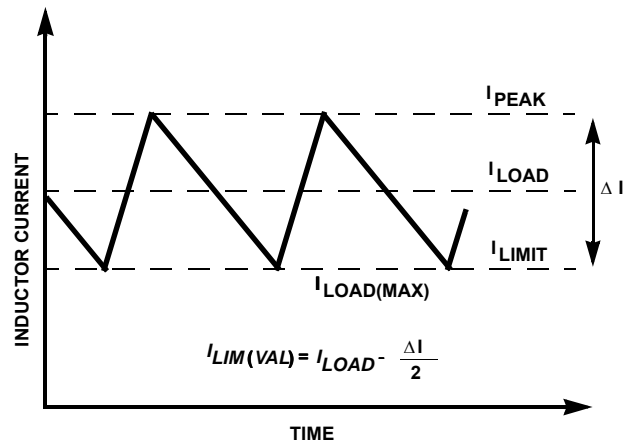

FIGURE 74. "VALLEY" CURRENT LIMIT THRESHOLD POINT

For lower power dissipation, the ISL6236A uses the ON-resistance of the synchronous rectifier as the current-sense element. Use the worst-case maximum value for  $r_{DS(ON)}$  from the MOSFET data sheet. Add some margin for the rise in  $r_{DS(ON)}$  with temperature. A good general rule is to allow 0.5% additional resistance for each °C of temperature rise. The ISL6236A controller has a built-in 5µA current source as shown in Figure 75. Place the hottest power MOSFETs as close to the IC as possible for best thermal coupling. The current limit varies with the ON-resistance of the synchronous rectifier. When combined with the undervoltage-protection circuit, this current-limit method is effective in almost every circumstance.

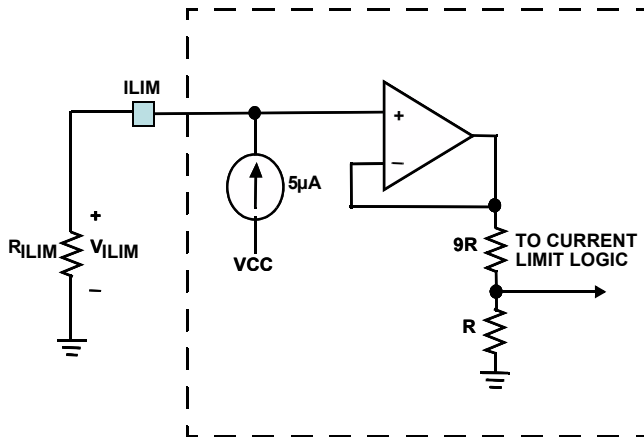

FIGURE 75. CURRENT LIMIT BLOCK DIAGRAM

A negative current limit prevents excessive reverse inductor currents when VOUT sinks current. The negative current-limit threshold is set to approximately 120% of the positive current limit and therefore tracks the positive current limit when ILIM is adjusted. The current-limit threshold is adjusted with an external resistor for ISL6236A at ILIM. The current-limit threshold adjustment range is from 20mV to 200mV. In the adjustable mode, the current-limit threshold voltage is 1/10th the voltage at ILIM. The voltage at ILIM pin is the product of  $5\mu\text{A} \cdot R_{ILIM}$ . The threshold defaults to 100mV when ILIM is connected to VCC. The logic threshold for switch-over to the 100mV default value is approximately  $V_{CC} - 1\text{V}$ .

The PC board layout guidelines should be carefully observed to ensure that noise and DC errors do not corrupt the current-sense signals at PHASE.

### MOSFET Gate Drivers (UGATE, LGATE)

The UGATE and LGATE gate drivers sink 2.0A and 3.3A respectively of gate drive, ensuring robust gate drive for high-current applications. The UGATE floating high-side MOSFET drivers are powered by diode-capacitor charge pumps at BOOT. The LGATE synchronous-rectifier drivers are powered by PVCC.

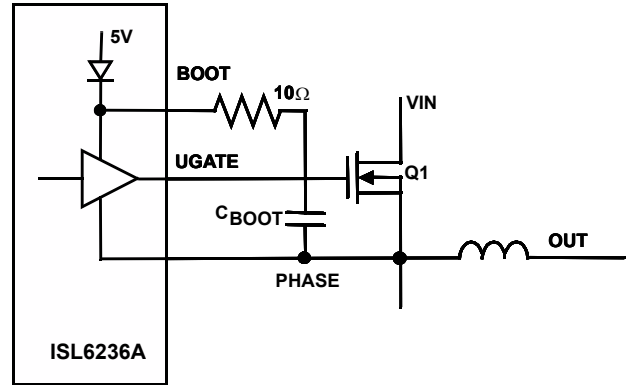

FIGURE 76. REDUCING THE SWITCHING-NODE RISE TIME

The internal pull-down transistors that drive LGATE low have a 0.6Ω typical ON-resistance. These low ON-resistance pull-down transistors prevent LGATE from being pulled up during the fast rise time of the inductor nodes due to capacitive coupling from the drain to the gate of the low-side synchronous-rectifier MOSFETs. However, for high-current applications, some combinations of high- and low-side MOSFETs may cause excessive gate-drain coupling, which leads to poor efficiency and EMI-producing shoot-through currents. Adding a 1Ω resistor in series with BOOT increases the turn-on time of the high-side MOSFETs at the expense of efficiency, without degrading the turn-off time (see Figure 76).

Adaptive dead-time circuits monitor the LGATE and UGATE drivers and prevent either FET from turning on until the other is fully off. This algorithm allows operation without shoot-through with a wide range of MOSFETs, minimizing delays and maintaining efficiency. There must be low-resistance, low-inductance paths from the gate drivers to the MOSFET gates for the adaptive dead-time circuit to work properly. Otherwise, the sense circuitry interprets the MOSFET gate as "off" when there is actually charge left on the gate. Use very short, wide traces measuring 10 to 20 squares (50 mils to 100 mils wide if the MOSFET is 1" from the device).

### Boost-Supply Capacitor Selection (Buck)

The boost capacitor should be 0.1µF to 4.7µF, depending on the input and output voltages, external components, and PC board layout. The boost capacitance should be as large as possible to prevent it from charging to excessive voltage, but small enough to adequately charge during the minimum low-side MOSFET conduction time, which happens at maximum operating duty cycle (this occurs at minimum input voltage). The minimum gate to source voltage ( $V_{GS(MIN)}$ ) is determined by:

$$V_{GS(MIN)} = PV_{CC} \cdot \frac{C_{BOOT}}{C_{BOOT} + C_{GS}} \quad (\text{EQ. 5})$$

where:

- PVCC is 5V
- $C_{GS}$  is the gate capacitance of the high-side MOSFET

### **Boost-Supply Refresh Monitor**

In pure skip mode, the converter frequency can be very low with little to no output loading. This produces very long off times, where leakage can bleed down the BOOT capacitor voltage. If the voltage falls too low, the converter may not be able to turn on UGATE when the output voltage falls to the reference. To prevent this, the ISL6236A monitors the BOOT capacitor voltage, and if it falls below 3V, it initiates an LGATE pulse, which will refresh the BOOT voltage.

### **POR, UVLO and Internal Digital Soft-Start**

Power-on reset (POR) occurs when  $V_{IN}$  rises above approximately 3V, resetting the undervoltage, overvoltage, and thermal-shutdown fault latches. PVCC undervoltage lockout (UVLO) circuitry inhibits switching when PVCC is below 4V. LGATE is low during UVLO. The output voltages begin to ramp up once PVCC exceeds its 4V UVLO and REF is in regulation. The internal digital soft-start timer begins to ramp up the maximum-allowed current limit during start-up. The 1.7ms ramp occurs in five steps. The step size are 20%, 40%, 60%, 80% and 100% of the positive current limit value.

### **Power-Good Output (POK)**

The POK comparator continuously monitors both output voltages for undervoltage conditions. POK is actively held low in shutdown, standby, and soft-start. POK1 releases and digital soft-start terminates when VOUT1 outputs reach the error-comparator threshold. POK1 goes low if VOUT1 output turns off or is 10% below its nominal regulation point. POK1 is a true open-drain output. Likewise, POK2 is used to monitor VOUT2.

### **Fault Protection**

The ISL6236A provides overvoltage/undervoltage fault protection in the buck controllers. Once activated, the controller continuously monitors the output for undervoltage and overvoltage fault conditions.

### **OUT-OF-BOUND CONDITION**

When the output voltage is 5% above the set voltage, the out-of-bound condition activates. LGATE turns on until output reaches within regulation. Once the output is within regulation, the controller will operate as normal. It is the "first line of defense" before OVP. The output voltage ripple must be sized low enough as to not nuisance trip the OOB threshold. The equations in "Output Capacitor Selection" on page 33 should be used to size the output voltage ripple below 3% of the nominal output voltage set point.

### **OVERVOLTAGE PROTECTION**

When the output voltage of VOUT1 is 11% (16% for VOUT2) above the set voltage, the overvoltage fault protection

activates. This latches on the synchronous rectifier MOSFET with 100% duty cycle, rapidly discharging the output capacitor until the negative current limit is achieved. Once negative current limit is met, UGATE is turned on for a minimum on-time, followed by another LGATE pulse until negative current limit. This effectively regulates the discharge current at the negative current limit in an effort to prevent excessively large negative currents that cause potentially damaging negative voltages on the load. Once an overvoltage fault condition is set, it can only be reset by toggling SHDN, EN, or cycling VIN (POR).

### **UNDERVOLTAGE PROTECTION**

When the output voltage drops below 70% of its regulation voltage for at least 100 $\mu$ s, the controller sets the fault latch and begins the discharge mode (see "Shutdown Mode" and "Discharge Mode" on page 30). UVP is ignored for at least 20ms (typical), after start-up or after a rising edge on EN. Toggle EN or cycle VIN (POR) to clear the undervoltage fault latch and restart the controller. UVP only applies to the buck outputs.

### **THERMAL PROTECTION**

The ISL6236A has thermal shutdown to protect the devices from overheating. Thermal shutdown occurs when the die temperature exceeds +150°C. All internal circuitry shuts down during thermal shutdown. The ISL6236A may trigger thermal shutdown if LDO is not bootstrapped from OUT while applying a high input voltage on VIN and drawing the maximum current (including short circuit) from LDO. Even if LDO is bootstrapped from OUT, overloading the LDO causes large power dissipation on the bootstrap switches, which may result in thermal shutdown. Cycling EN, EN LDO, or VIN (POR) ends the thermal-shutdown state.

### **Discharge Mode (Soft-Stop)**

When a transition to standby or shutdown mode occurs, or the output undervoltage fault latch is set, the outputs discharge to GND through an internal 25 $\Omega$  switch. The reference remains active to provide an accurate threshold and to provide overvoltage protection.

### **Shutdown Mode**

The ISL6236A SMPS1, SMPS2 and LDO have independent enabling control. Drive EN1, EN2 and EN LDO below the precise input falling-edge trip level to place the ISL6236A in its low-power shutdown state. The ISL6236A consumes only 20 $\mu$ A of quiescent current while in shutdown. When shutdown mode activates, the 3.3V VREF3 remain on. Both SMPS outputs are discharged to 0V through a 25 $\Omega$  switch.

### **Power-Up Sequencing and On/Off Controls (EN)**

EN1 and EN2 control SMPS power-up sequencing. EN1 or EN2 rising above 2.4V enables the respective outputs. EN1 or EN2 falling below 1.6V disables the respective outputs.

Connecting EN1 or EN2 to REF will force its outputs off while the other output is below regulation. The sequenced SMPS will

start once the other SMPS reaches regulation. The second SMPS remains on until the first SMPS turns off, the device shuts down, a fault occurs or PVCC goes into undervoltage lockout. Both supplies begin their power-down sequence

immediately when the first supply turns off. Driving EN below 0.8V clears the overvoltage, undervoltage and thermal fault latches.

**TABLE 3. OPERATING-MODE TRUTH TABLE**

MODE	CONDITION	COMMENT
Power-Up	PVCC < UVLO threshold.	Transitions to discharge mode after a VIN POR and after REF becomes valid. LDO, VREF3 and REF remain active.
Run	EN LDO = high, EN1 or EN2 enabled.	Normal operation
Overvoltage Protection	Either output > 111% (VOUT1) or 116% (VOUT2) of nominal level.	LGATE is forced high. LDO, VREF3 and REF active. Exited by a VIN POR, or by toggling EN1 or EN2.
Undervoltage Protection	Either output < 70% of nominal after 20ms time-out expires and output is enabled.	The internal 25Ω switch turns on. LDO, VREF3 and REF are active. Exited by a VIN POR or by toggling EN1 or EN2.
Discharge	Either SMPS output is still high in either standby mode or shutdown mode	Discharge switch (25Ω) connects OUT to GND. One output may still run while the other is in discharge mode. Activates when PVCC is in UVLO, or transition to UVLO, standby, or shutdown has begun. LDO, VREF3 and REF active.
Standby	EN1, EN2 < start-up threshold, EN LDO = High	LDO, VREF3 and REF active.
Shutdown	EN1, EN2, EN LDO = low	Discharge switch (25Ω) connects OUT to PGND. All circuitry off except VREF3.
Thermal Shutdown	TJ > +150°C	All circuitry off. Exited by VIN POR or cycling EN. VREF3 remain active.

**TABLE 4. SHUTDOWN AND STANDBY CONTROL LOGIS**

VEN LDO	VEN1 (V)	VEN2 (V)	LDO	SMPS1	SMPS2
Low	Low	Low	Off	Off	Off
">2.5" → High	Low	Low	On	Off	Off
">2.5" → High	High	High	On	On	On
">2.5" → High	High	Low	On	On	Off
">2.5" → High	Low	High	On	Off	On
">2.5" → High	High	REF	On	On	On (after SMPS1 is up)
">2.5" → High	REF	High	On	On (after SMPS2 is up)	On

### Adjustable-Output Feedback (Dual-Mode FB)

Connect FB1 to GND to enable the fixed 5V or tie FB1 to VCC to set the fixed 1.5V output. Connect a resistive voltage-divider at FB1 between OUT1 and GND to adjust the respective output voltage between 0.7V and 5.5V (see Figure 77). Choose  $R_2$  to be approximately 10k and solve for  $R_1$  using Equation 6.

$$R_1 = R_2 \cdot \left( \frac{V_{OUT1}}{V_{FB1}} - 1 \right) \quad (\text{EQ. 6})$$

where  $V_{FB1} = 0.7V$  nominal.

Likewise, connect REFIN2 to VCC to enable the fixed 3.3V or tie REFIN2 to VREF3 to set the fixed 1.05V output. Set REFIN2 from 0V to 2.50V for SMPS2 tracking mode (see Figure 78).

$$R_3 = R_4 \cdot \left( \frac{VR}{V_{OUT2}} - 1 \right) \quad (\text{EQ. 7})$$

where:

- $VR = 2V$  nominal (if tied to REF)

or

- $VR = 3.3V$  nominal (if tied to VREF3)

### Design Procedure

Establish the input voltage range and maximum load current before choosing an inductor and its associated ripple current ratio (LIR). The following four factors dictate the rest of the design:

1. **Input Voltage Range.** The maximum value ( $V_{IN(MAX)}$ ) must accommodate the maximum AC adapter voltage. The minimum value ( $V_{IN(MIN)}$ ) must account for the lowest input voltage after drops due to connectors, fuses and battery selector switches. Lower input voltages result in better efficiency.
2. **Maximum Load Current.** The peak load current ( $I_{LOAD(MAX)}$ ) determines the instantaneous component stress and filtering requirements and thus drives output capacitor selection, inductor saturation rating and the design of the current-limit circuit. The continuous load current ( $I_{LOAD}$ ) determines the thermal stress and drives the selection of input capacitors, MOSFETs and other critical heat-contributing components.
3. **Switching Frequency.** This choice determines the basic trade-off between size and efficiency. The optimal frequency is largely a function of maximum input voltage and MOSFET switching losses.
4. **Inductor Ripple Current Ratio (LIR).** LIR is the ratio of the peak-peak ripple current to the average inductor current. Size and efficiency trade-offs must be considered when setting the inductor ripple current ratio. Low inductor values cause large ripple currents, resulting in the smallest size, but poor efficiency and high output noise. Also, total output ripple above 3.5% of the output regulation will cause controller to trigger out-of-bound condition. The minimum

practical inductor value is one that causes the circuit to operate at critical conduction (where the inductor current just touches zero with every cycle at maximum load). Inductor values lower than this grant no further size-reduction benefit.

The ISL6236A pulse-skipping algorithm ( $\overline{SKIP} = GND$ ) initiates skip mode at the critical conduction point, so the inductor's operating point also determines the load current at which PWM/PFM switchover occurs. The optimum LIR point is usually found between 25% and 50% ripple current.

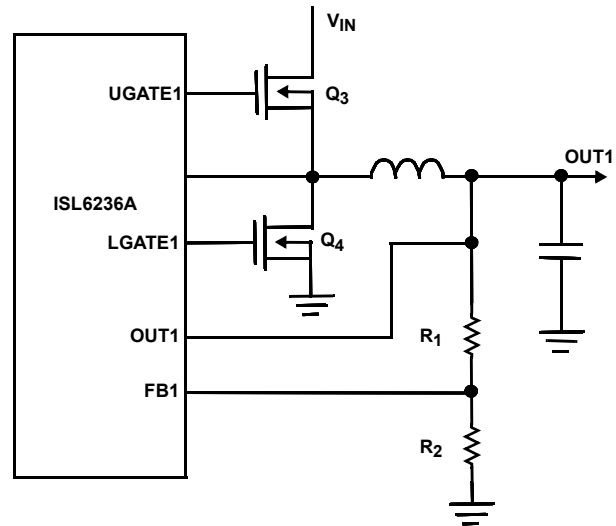

FIGURE 77. SETTING  $V_{OUT1}$  WITH A RESISTOR DIVIDER

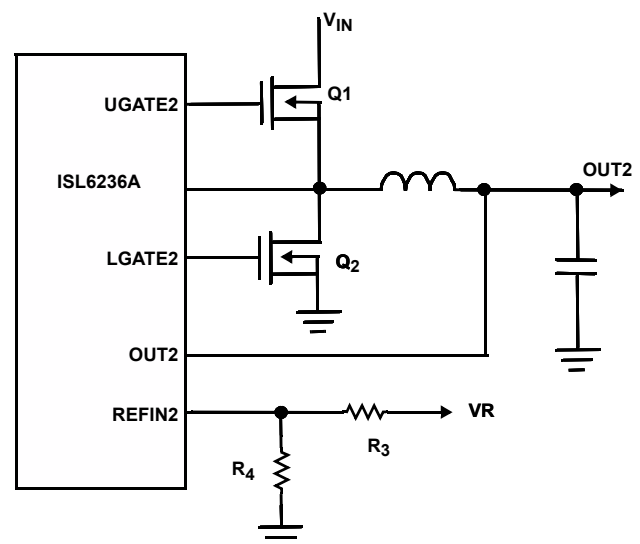

FIGURE 78. SETTING  $V_{OUT2}$  WITH A VOLTAGE DIVIDER FOR TRACKING



### Inductor Selection

The switching frequency (on-time) and operating point (% ripple or LIR) determine the inductor value using Equation 8:

$$L = \frac{V_{OUT} \cdot (V_{IN} + V_{OUT})}{V_{IN} \cdot f \cdot LIR \cdot I_{LOAD(MAX)}} \quad (\text{EQ. 8})$$

Example:  $I_{LOAD(MAX)} = 5A$ ,  $V_{IN} = 12V$ ,  $V_{OUT} = 5V$ ,  $f = 200kHz$ , 35% ripple current or  $LIR = 0.35$ :

$$L = \frac{5V(12V - 5V)}{12V \cdot 200kHz \cdot 0.35 \cdot 5A} = 8.3\mu H \quad (\text{EQ. 9})$$

Find a low-loss inductor having the lowest possible DC resistance that fits in the allotted dimensions. Ferrite cores are often the best choice. The core must be large enough not to saturate at the peak inductor current ( $I_{PEAK}$ ) shown in Equation 10:

$$I_{PEAK} = I_{LOAD(MAX)} + [(LIR/2) \cdot I_{LOAD(MAX)}] \quad (\text{EQ. 10})$$

The inductor ripple current also impacts transient response performance, especially at low  $V_{IN} - V_{OUT}$  differences. Low inductor values allow the inductor current to slew faster, replenishing charge removed from the output filter capacitors by a sudden load step. The peak amplitude of the output transient ( $V_{SAG}$ ) is also a function of the maximum duty factor, which can be calculated from the on-time and minimum off-time:

$$V_{SAG} = \frac{(\Delta I_{LOAD(MAX)})^2 \cdot L \left( K \left( \frac{V_{OUT}}{V_{IN}} + t_{OFF(MIN)} \right) \right)}{2 \cdot C_{OUT} \cdot V_{OUT} \left[ K \left( \frac{V_{IN} - V_{OUT}}{V_{IN}} \right) - t_{OFF(MIN)} \right]} \quad (\text{EQ. 11})$$

where minimum off-time =  $0.35\mu s$  (max) and  $K$  is from Table 2.

### Determining the Current Limit

The minimum current-limit threshold must be great enough to support the maximum load current when the current limit is at the minimum tolerance value. The valley of the inductor current occurs at  $I_{LOAD(MAX)}$  minus half of the ripple current; therefore:

$$I_{LIMIT(LOW)} > I_{LOAD(MAX)} - [(LIR/2) \cdot I_{LOAD(MAX)}] \quad (\text{EQ. 12})$$

where:  $I_{LIMIT(LOW)}$  = minimum current-limit threshold voltage divided by the  $r_{DS(ON)}$  of  $Q_2/Q_4$ .

Use the worst-case maximum value for  $r_{DS(ON)}$  from the MOSFET  $Q_2/Q_4$  data sheet and add some margin for the rise in  $r_{DS(ON)}$  with temperature. A good general rule is to allow 0.2% additional resistance for each °C of temperature rise.

Examining the 5A circuit example with a maximum  $r_{DS(ON)} = 5m\Omega$  at room temperature. At +125°C reveals the following:

$$I_{LIMIT(LOW)} = (25mV) / ((5m\Omega \times 1.2) > 5A - (0.35/2)5A) \quad (\text{EQ. 13})$$

$$4.17A > 4.12A \quad (\text{EQ. 14})$$

4.17A is greater than the valley current of 4.12A, so the circuit can easily deliver the full-rated 5A using the 30mV nominal current-limit threshold voltage.

### Output Capacitor Selection

The output filter capacitor must have low enough equivalent series resistance (ESR) to meet output ripple and load-transient requirements, yet have high enough ESR to satisfy stability requirements. The output capacitance must also be high enough to absorb the inductor energy while transitioning from full-load to no-load conditions without tripping the overvoltage fault latch. In applications where the output is subject to large load transients, the output capacitor's size depends on how much ESR is needed to prevent the output from dipping too low under a load transient. Ignoring the sag due to finite capacitance:

$$R_{SER} \leq \frac{V_{DIP}}{I_{LOAD(MAX)}} \quad (\text{EQ. 15})$$

where  $V_{DIP}$  is the maximum-tolerable transient voltage drop. In non-CPU applications, the output capacitor's size depends on how much ESR is needed to maintain an acceptable level of output voltage ripple:

$$R_{ESR} \leq \frac{V_{P-P}}{I_{IR} \cdot I_{LOAD(MAX)}} \quad (\text{EQ. 16})$$

where  $V_{P-P}$  is the peak-to-peak output voltage ripple. The actual capacitance value required relates to the physical size needed to achieve low ESR, as well as to the chemistry of the capacitor technology. Thus, the capacitor is usually selected by ESR and voltage rating rather than by capacitance value (this is true of tantalum, OS-CON, and other electrolytic-type capacitors).

When using low-capacity filter capacitors such as polymer types, capacitor size is usually determined by the capacity required to prevent  $V_{SAG}$  and  $V_{SOAR}$  from tripping the undervoltage and overvoltage fault latches during load transients in ultrasonic mode.

For low input-to-output voltage differentials ( $V_{IN}/V_{OUT} < 2$ ), additional output capacitance is required to maintain stability and good efficiency in ultrasonic mode. The amount of overshoot due to stored inductor energy can be calculated as shown in Equation 17:

$$V_{SOAR} = \frac{I_{PEAK}^2 \cdot L}{2 \cdot C_{OUT} \cdot V_{OUT}} \quad (\text{EQ. 17})$$

where  $I_{PEAK}$  is the peak inductor current.

### Input Capacitor Selection

The input capacitors must meet the input-ripple-current ( $I_{RMS}$ ) requirement imposed by the switching current. The ISL6236A dual switching regulator operates at different frequencies. This interleaves the current pulses drawn by the two switches and reduces the overlap time where they add together. The input RMS current is much smaller in comparison than with both SMPSs operating in phase. The input RMS current varies with load and the input voltage.

The maximum input capacitor RMS current for a single SMPS is given by Equation 18:

$$I_{RMS} \approx I_{LOAD} \left( \frac{\sqrt{V_{OUT}(V_{IN} - V_{OUT})}}{V_{IN}} \right) \quad (\text{EQ. 18})$$

When  $V_{IN} = 2 \cdot V_{OUT}$  ( $D = 50\%$ ),  $I_{RMS}$  has maximum current of  $I_{LOAD}/2$ .

The ESR of the input-capacitor is important for determining capacitor power dissipation. All the power ( $I_{RMS}^2 \times \text{ESR}$ ) heats up the capacitor and reduces efficiency. Nontantalum chemistries (ceramic or OS-CON) are preferred due to their low ESR and resilience to power-up surge currents. Choose input capacitors that exhibit less than  $+10^\circ\text{C}$  temperature rise at the RMS input current for optimal circuit longevity. Place the drains of the high-side switches close to each other to share common input bypass capacitors.

### Power MOSFET Selection

Most of the following MOSFET guidelines focus on the challenge of obtaining high load-current capability ( $>5\text{A}$ ) when using high-voltage ( $>20\text{V}$ ) AC adapters. Low-current applications usually require less attention.

Choose a high-side MOSFET ( $Q_1/Q_3$ ) that has conduction losses equal to the switching losses at the typical battery voltage for maximum efficiency. Ensure that the conduction losses at the minimum input voltage do not exceed the package thermal limits or violate the overall thermal budget. Ensure that conduction losses plus switching losses at the maximum input voltage do not exceed the package ratings or violate the overall thermal budget.

Choose a synchronous rectifier ( $Q_2/Q_4$ ) with the lowest possible  $r_{DS(ON)}$ . Ensure the gate is not pulled up by the high-side switch turning on due to parasitic drain-to-gate capacitance, causing cross-conduction problems. Switching losses are not an issue for the synchronous rectifier in the buck topology since it is a zero-voltage switched device when using the buck topology.

### MOSFET Power Dissipation

Worst-case conduction losses occur at the duty-factor extremes. For the high-side MOSFET, the worst-case power dissipation (PD) due to the MOSFET's  $r_{DS(ON)}$  occurs at the minimum battery voltage, as shown in Equation 19:

$$PD(Q_H \text{ Resistance}) = \left( \frac{V_{OUT}}{V_{IN(MIN)}} \right) (I_{LOAD})^2 \cdot r_{DS(ON)} \quad (\text{EQ. 19})$$

Generally, a small high-side MOSFET reduces switching losses at high input voltage. However, the  $r_{DS(ON)}$  required to stay within package power-dissipation limits often limits how small the MOSFET can be. The optimum situation occurs when the switching (AC) losses equal the conduction ( $r_{DS(ON)}$ ) losses.

Switching losses in the high-side MOSFET can become an insidious heat problem when maximum battery voltage is applied, due to the squared term in the  $CV^2f$  switching-loss equation. Reconsider the high-side MOSFET chosen for adequate  $r_{DS(ON)}$  at low battery voltages if it becomes extraordinarily hot when subjected to  $V_{IN(MAX)}$ .

Calculating the power dissipation in NH ( $Q_1/Q_3$ ) due to switching losses is difficult since it must allow for quantifying factors that influence the turn-on and turn-off times. These factors include the internal gate resistance, gate charge, threshold voltage, source inductance, and PC board layout characteristics. The following switching-loss calculation provides only a very rough estimate and is no substitute for bench evaluation, preferably including verification using a thermocouple mounted on NH ( $Q_1/Q_3$ ):

$$PD(Q_H \text{ Switching}) = (V_{IN(MAX)})^2 \left( \frac{C_{RSS} \cdot f_{SW} \cdot I_{LOAD}}{I_{GATE}} \right)^2 \quad (\text{EQ. 20})$$

where  $C_{RSS}$  is the reverse transfer capacitance of  $Q_H$  ( $Q_1/Q_3$ ) and  $I_{GATE}$  is the peak gate-drive source/sink current.

For the synchronous rectifier, the worst-case power dissipation always occurs at maximum battery voltage:

$$PD(Q_L) = \left( 1 - \frac{V_{OUT}}{V_{IN(MAX)}} \right) I_{LOAD}^2 \cdot r_{DS(ON)} \quad (\text{EQ. 21})$$

The absolute worst case for MOSFET power dissipation occurs under heavy overloads that are greater than  $I_{LOAD(MAX)}$  but are not quite high enough to exceed the current limit and cause the fault latch to trip. To protect against this possibility, "overdesign" the circuit to tolerate:

$$I_{LOAD} = I_{LIMIT(HIGH)} + ((LIR)/2) \cdot I_{LOAD(MAX)} \quad (\text{EQ. 22})$$

where  $I_{LIMIT(HIGH)}$  is the maximum valley current allowed by the current-limit circuit, including threshold tolerance and resistance variation.

### Rectifier Selection

Current circulates from ground to the junction of both MOSFETs and the inductor when the high-side switch is off. As a consequence, the polarity of the switching node is negative with respect to ground. This voltage is approximately  $-0.7\text{V}$  (a diode drop) at both transition edges while both switches are off

(dead time). The drop is  $I_L \cdot r_{DS(ON)}$  when the low-side switch conducts.

The rectifier is a clamp across the synchronous rectifier that catches the negative inductor swing during the dead time between turning the high-side MOSFET off and the synchronous rectifier on. The MOSFETs incorporate a high-speed silicon body diode as an adequate clamp diode if efficiency is not of primary importance. Place a Schottky diode in parallel with the body diode to reduce the forward voltage drop and prevent the Q<sub>2</sub>/Q<sub>4</sub> MOSFET body diodes from turning on during the dead time. Typically, the external diode improves the efficiency by 1% to 2%. Use a Schottky diode with a DC current rating equal to one-third of the load current. For example, use an MBR0530 (500mA-rated) type for loads up to 1.5A, a 1N5817 type for loads up to 3A, or a 1N5821 type for loads up to 10A. The rectifier's rated reverse breakdown voltage must be at least equal to the maximum input voltage, preferably with a 20% derating factor.

## Applications Information

### Dropout Performance

The output voltage-adjust range for continuous-conduction operation is restricted by the nonadjustable 350ns (max) minimum off-time one-shot. Use the slower 5V SMPS for the higher of the two output voltages for best dropout performance in adjustable feedback mode. The duty-factor limit must be calculated using worst-case values for on- and off-times, when working with low input voltages. Manufacturing tolerances and internal propagation delays introduce an error to the  $t_{ON}$  K-factor. Also, keep in mind that transient-response performance of buck regulators operated close to dropout is poor, and bulk output capacitance must often be added (see Equation 11 on page 33).

The absolute point of dropout occurs when the inductor current ramps down during the minimum off-time ( $\Delta I_{DOWN}$ ) as much as it ramps up during the on-time ( $\Delta I_{UP}$ ). The ratio  $h = \Delta I_{UP} / \Delta I_{DOWN}$  indicates the ability to slew the inductor current higher in response to increased load, and must always be greater than 1. As  $h$  approaches 1, the absolute minimum dropout point, the inductor current is less able to increase during each switching cycle and  $V_{SAG}$  greatly increases unless additional output capacitance is used.

A reasonable minimum value for  $h$  is 1.5, but this can be adjusted up or down to allow trade-offs between  $V_{SAG}$ , output capacitance and minimum operating voltage. For a given value of  $h$ , the minimum operating voltage can be calculated in Equation 23:

$$V_{IN(MIN)} = \frac{(V_{OUT} + V_{DROP})}{1 - \left(\frac{t_{OFF(MIN)} \cdot h}{K}\right)} + V_{DROP2} - V_{DROP1} \quad (\text{EQ. 23})$$

where  $V_{DROP1}$  and  $V_{DROP2}$  are the parasitic voltage drops in the discharge and charge paths (see "ON-TIME ONE-SHOT

( $t_{ON}$ )" on page 20),  $t_{OFF(MIN)}$  is from "Electrical Specifications" table on page 6 and  $K$  is taken from Table 2. The absolute minimum input voltage is calculated with  $h = 1$ .

Operating frequency must be reduced or  $h$  must be increased and output capacitance added to obtain an acceptable  $V_{SAG}$  if calculated  $V_{IN(MIN)}$  is greater than the required minimum input voltage. Calculate  $V_{SAG}$  to be sure of adequate transient response if operation near dropout is anticipated.

Dropout Design Example:

ISL6236A: With  $V_{OUT2} = 5V$ ,  $f_{sw} = 400kHz$ ,  $K = 2.25\mu s$ ,  $t_{OFF(MIN)} = 350ns$ ,  $V_{DROP1} = V_{DROP2} = 100mV$ , and  $h = 1.5$ , the minimum  $V_{IN}$  is:

$$V_{IN(MIN)} = \frac{(5V + 0.1V)}{1 - \left(\frac{0.35\mu s \cdot 1.5}{2.25\mu s}\right)} + 0.1V - 0.1V = 6.65V \quad (\text{EQ. 24})$$

Calculating with  $h = 1$  yields:

$$V_{IN(MIN)} = \frac{(5V + 0.1V)}{1 - \left(\frac{0.35\mu s \cdot 1}{2.25\mu s}\right)} + 0.1V - 0.1V = 6.04V \quad (\text{EQ. 25})$$

Therefore,  $V_{IN}$  must be greater than 6.65V. A practical input voltage with reasonable output capacitance would be 7.5V.

### PC Board Layout Guidelines

Careful PC board layout is critical to achieve minimal switching losses and clean, stable operation. This is especially true when multiple converters are on the same PC board where one circuit can affect the other. Refer to the ISL6236 Evaluation Kit Application Notes (AN1271 and AN1272) for a specific layout example.

Mount all of the power components on the top side of the board with their ground terminals flush against one another, if possible. Follow these guidelines for good PC board layout:

- Isolate the power components on the top side from the sensitive analog components on the bottom side with a ground shield. Use a separate PGND plane under the OUT1 and OUT2 sides (called PGND1 and PGND2). Avoid the introduction of AC currents into the PGND1 and PGND2 ground planes. Run the power plane ground currents on the top side only, if possible.
- Use a star ground connection on the power plane to minimize the crosstalk between OUT1 and OUT2.
- Keep the high-current paths short, especially at the ground terminals. This practice is essential for stable, jitter-free operation.
- Keep the power traces and load connections short. This practice is essential for high efficiency. Using thick copper PC boards (2oz vs 1oz) can enhance full-load efficiency by 1% or more. Correctly routing PC board traces must be approached in terms of fractions of centimeters, where a

single  $m\Omega$  of excess trace resistance causes a measurable efficiency penalty.

- PHASE (ISL6236A) and GND connections to the synchronous rectifiers for current limiting must be made using Kelvin-sense connections to guarantee the current-limit accuracy with 8 Ld SO MOSFETs. This is best done by routing power to the MOSFETs from outside using the top copper layer, while connecting PHASE traces inside (underneath) the MOSFETs.
- When trade-offs in trace lengths must be made, it is preferable to allow the inductor charging path to be made longer than the discharge path. For example, it is better to allow some extra distance between the input capacitors and the high-side MOSFET than to allow distance between the inductor and the synchronous rectifier or between the inductor and the output filter capacitor.
- Ensure that the OUT connection to  $C_{OUT}$  is short and direct. However, in some cases it may be desirable to deliberately introduce some trace length between the OUT connector node and the output filter capacitor.
- Route high-speed switching nodes (BOOT, UGATE, PHASE, and LGATE ) away from sensitive analog areas (REF, ILIM, and FB ). Use PGND1 and PGND2 as an EMI shield to keep radiated switching noise away from the IC's feedback divider and analog bypass capacitors.
- Make all pin-strap control input connections ( $\overline{SKIP}$ , ILIM, etc.) to GND or VCC of the device.

### Layout Procedure

Place the power components first with ground terminals adjacent ( $Q_2/Q_4$  source,  $C_{IN}$ ,  $C_{OUT}$  ). If possible, make all these connections on the top layer with wide, copper-filled areas.

Mount the controller IC adjacent to the synchronous rectifier MOSFETs close to the hottest spot, preferably on the back side in order to keep UGATE, GND, and the LGATE gate drive lines short and wide. The LGATE gate trace must be short and wide, measuring 50 mils to 100 mils wide if the MOSFET is 1" from the controller device.

Group the gate-drive components (BOOT capacitor, VIN bypass capacitor) together near the controller device.

Make the DC/DC controller ground connections as follows:

1. Near the device, create a small analog ground plane.
2. Connect the small analog ground plane to GND and use the plane for the ground connection for the REF and VCC bypass capacitors, FB dividers and ILIM resistors (if any).
3. Create another small ground island for PGND and use the plane for the VIN bypass capacitor, placed very close to the device.
4. Connect the GND and PGND planes together at the metal tab under device.

On the board's top side (power planes), make a star ground to minimize crosstalk between the two sides. The top-side star ground is a star connection of the input capacitors and synchronous rectifiers. Keep the resistance low between the star ground and the source of the synchronous rectifiers for accurate current limit. Connect the top-side star ground (used for MOSFET, input, and output capacitors) to the small island with a single short, wide connection (preferably just a via). Create PGND islands on the layer just below the top-side layer (refer to ISL6236 Evaluation Kit Application Notes, AN1271 and AN1272 for an example) to act as an EMI shield if multiple layers are available (highly recommended). Connect each of these individually to the star ground via, which connects the top side to the PGND plane. Add one more solid ground plane under the device to act as an additional shield, and also connect the solid ground plane to the star ground via.

Connect the output power planes (VCORE and system ground planes) directly to the output filter capacitor positive and negative terminals with multiple vias.

© Copyright Intersil Americas LLC 2007-2008. All Rights Reserved.

All trademarks and registered trademarks are the property of their respective owners.

For additional products, see [www.intersil.com/en/products.html](http://www.intersil.com/en/products.html)

Intersil products are manufactured, assembled and tested utilizing ISO9001 quality systems as noted in the quality certifications found at [www.intersil.com/en/support/qualandreliability.html](http://www.intersil.com/en/support/qualandreliability.html)

*Intersil products are sold by description only. Intersil may modify the circuit design and/or specifications of products at any time without notice, provided that such modification does not, in Intersil's sole judgment, affect the form, fit or function of the product. Accordingly, the reader is cautioned to verify that datasheets are current before placing orders. Information furnished by Intersil is believed to be accurate and reliable. However, no responsibility is assumed by Intersil or its subsidiaries for its use; nor for any infringements of patents or other rights of third parties which may result from its use. No license is granted by implication or otherwise under any patent or patent rights of Intersil or its subsidiaries.*

For information regarding Intersil Corporation and its products, see [www.intersil.com](http://www.intersil.com)

# Package Outline Drawing

## L32.5x5B

### 32 LEAD QUAD FLAT NO-LEAD PLASTIC PACKAGE

Rev 2, 11/07

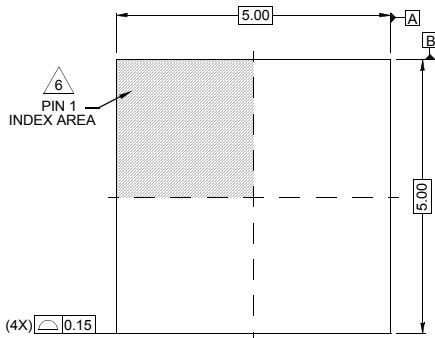

TOP VIEW

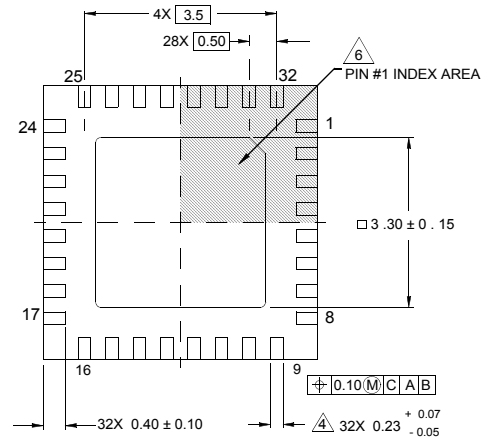

BOTTOM VIEW

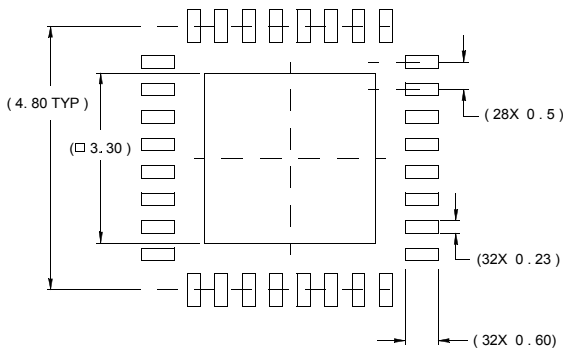

TYPICAL RECOMMENDED LAND PATTERN

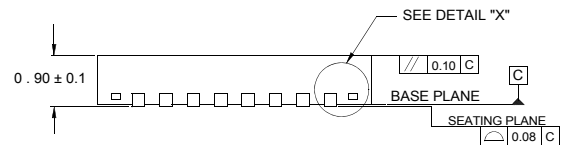

SIDE VIEW

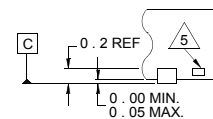

DETAIL "X"

NOTES:

1. Dimensions are in millimeters.  
Dimensions in ( ) for Reference Only.
2. Dimensioning and tolerancing conform to AMSE Y14.5m-1994.
3. Unless otherwise specified, tolerance : Decimal ± 0.05
4. Dimension b applies to the metallized terminal and is measured between 0.15mm and 0.30mm from the terminal tip.
5. Tiebar shown (if present) is a non-functional feature.
6. The configuration of the pin #1 identifier is optional, but must be located within the zone indicated. The pin #1 identifier may be either a mold or mark feature.



Компания «ЭлектроПласт» предлагает заключение долгосрочных отношений при поставках импортных электронных компонентов на взаимовыгодных условиях!

Наши преимущества:

- Оперативные поставки широкого спектра электронных компонентов отечественного и импортного производства напрямую от производителей и с крупнейших мировых складов;
- Поставка более 17-ти миллионов наименований электронных компонентов;
- Поставка сложных, дефицитных, либо снятых с производства позиций;
- Оперативные сроки поставки под заказ (от 5 рабочих дней);
- Экспресс доставка в любую точку России;
- Техническая поддержка проекта, помощь в подборе аналогов, поставка прототипов;
- Система менеджмента качества сертифицирована по Международному стандарту ISO 9001;
- Лицензия ФСБ на осуществление работ с использованием сведений, составляющих государственную тайну;
- Поставка специализированных компонентов (Xilinx, Altera, Analog Devices, Intersil, Interpoint, Microsemi, Aeroflex, Peregrine, Syfer, Eurofarad, Texas Instrument, Miteq, Cobham, E2V, MA-COM, Hittite, Mini-Circuits, General Dynamics и др.);

Помимо этого, одним из направлений компании «ЭлектроПласт» является направление «Источники питания». Мы предлагаем Вам помощь Конструкторского отдела:

- Подбор оптимального решения, техническое обоснование при выборе компонента;
- Подбор аналогов;
- Консультации по применению компонента;
- Поставка образцов и прототипов;
- Техническая поддержка проекта;
- Защита от снятия компонента с производства.



#### Как с нами связаться

**Телефон:** 8 (812) 309 58 32 (многоканальный)

**Факс:** 8 (812) 320-02-42

**Электронная почта:** [org@eplast1.ru](mailto:org@eplast1.ru)

**Адрес:** 198099, г. Санкт-Петербург, ул. Калинина, дом 2, корпус 4, литера А.