

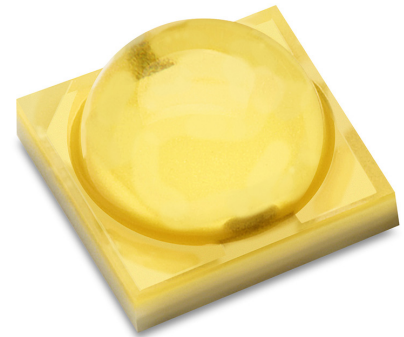

LUXEON V2

Best performance. Most usable light.
Proven package.

LUXEON V2 is a Chip Scale Package (CSP) based high power domed emitter optimized for directional applications to continue Lumileds leadership in this category. LUXEON V2 delivers high efficacy and robustness in a 3535 package with 3-stripe footprint designed to accelerate time to market by matching the radiation pattern of LUXEON TX while improving system costs through unparalleled performance (flux and efficacy) at higher drive currents.



FEATURES AND BENEFITS

450 lumens at 150 lm/W

CSP technology enables high efficacy at high drive current—2.4A max current

Radiation pattern matched to LUXEON TX

3535 package with 3-stripe footprint for ease of design

PRIMARY APPLICATIONS

Architectural

High Bay & Low Bay

Outdoor

- Stadium
- Street and Area Lighting

Table of Contents

General Product Information	2
Product Test Conditions	2
Part Number Nomenclature	2
Lumen Maintenance	2
Environmental Compliance	2
Performance Characteristics	3
Product Selection Guide	3
Optical Characteristics	3
Electrical and Thermal Characteristics	4
Absolute Maximum Ratings	4
Characteristic Curves	5
Spectral Power Distribution Characteristics	5
Light Output Characteristics	5
Forward Current Characteristics	6
Radiation Pattern Characteristics	7
Product Bin and Labeling Definitions	8
Decoding Product Bin Labeling	8
Luminous Flux Bins	8
Color Bin Definitions	9
Forward Voltage Bins	10
Mechanical Dimensions	10
Reflow Soldering Guidelines	11
JEDEC Moisture Sensitivity	11
Solder Pad Design	12
Packaging Information	13
Pocket Tape Dimensions	13
Reel Dimensions	13

General Product Information

Product Test Conditions

LUXEON V2 LEDs are tested and binned with a DC drive current of 700mA, at a junction temperature, T_j , of 85°C.

Part Number Nomenclature

Part numbers for LUXEON V2 follow the convention below:

L 1 V 2 – **A A B B** 0 0 0 0 0 **C C C** 0

Where:

- A A** – designates nominal ANSI CCT (30=3000K, 40=4000K, 50=5000K, 57=5700K, 65=6500K)
- B B** – designates minimum CRI (70=70CRI)
- C C C** – designates minimum luminous flux level at test conditions (290=290 lumens, etc.)

Therefore, the following part number is used for a LUXEON V2 4000K 70CRI 300 lumens:

L 1 V 2 – **4 0 7 0** 0 0 0 0 0 **3 0 0** 0

Lumen Maintenance

Please contact your local Sales Representative or Lumileds Technical Solutions Manager for more information about the long-term performance of this product.

Environmental Compliance

Lumileds LLC is committed to providing environmentally friendly products to the solid-state lighting market. LUXEON V2 is compliant to the European Union directives on the restriction of hazardous substances in electronic equipment, namely the RoHS Directive 2011/65/EU and REACH Regulation (EC) 1907/2006. Lumileds LLC will not intentionally add the following restricted materials to its products: lead, mercury, cadmium, hexavalent chromium, polybrominated biphenyls (PBB) or polybrominated diphenyl ethers (PBDE).

Performance Characteristics

Product Selection Guide

Table 1. Product performance of LUXEON V2 at 700mA and 2000mA, $T_j=85^{\circ}\text{C}$.

NOMINAL CCT	MINIMUM CRI ^[1]	LUMINOUS FLUX ^[2] (lm)		TYPICAL LUMINOUS EFFICACY (lm/W)	TYPICAL LUMINOUS FLUX (lm)	TYPICAL LUMINOUS EFFICACY (lm/W)	PART NUMBER
		MINIMUM	TYPICAL				
		700mA					
4000K	70	290	315	159	760	123	L1V2-4070000000000
5000K	70	290	315	159	760	123	L1V2-5070000000000
5700K	70	290	315	159	760	123	L1V2-5770000000000
6500K	70	290	310	156	748	121	L1V2-6570000000000

Notes for Table 1:

1. Lumileds maintains a tolerance of ± 2 on CRI.
2. Lumileds maintains a tester tolerance of $\pm 6.5\%$ on luminous flux measurements.

Optical Characteristics

Table 2. Optical characteristics for LUXEON V2 at 700mA, $T_j=85^{\circ}\text{C}$.

PART NUMBER	TYPICAL TOTAL INCLUDED ANGLE ^[1]	TYPICAL VIEWING ANGLE ^[2]
L1V2-xxxx00000xxx0	160°	120°

Notes for Table 2:

1. Total angle at which 90% of total luminous flux is captured.
2. Viewing angle is the off axis angle from the LED centerline where the luminous intensity is $\frac{1}{2}$ of the peak value.

Electrical and Thermal Characteristics

Table 3. Electrical and thermal characteristics for LUXEON V2 at 700mA, T_j=85°C.

PART NUMBER	FORWARD VOLTAGE ^[1] (V _f)			TYPICAL TEMPERATURE COEFFICIENT OF FORWARD VOLTAGE ^[2] (mV/°C)	TYPICAL THERMAL RESISTANCE—JUNCTION TO SOLDER PAD (°C/W)
	MINIMUM	TYPICAL	MAXIMUM		
L1V2-xxxxx0000xxx0	2.65	2.83	3.00	-1.6	3.0

Notes for Table 3:

1. Lumileds maintains a tolerance of ±0.06V on forward voltage measurements.
2. Measured between 25°C and 110°C.

Absolute Maximum Ratings

Table 4. Absolute maximum ratings for LUXEON V2.

PARAMETER	MAXIMUM PERFORMANCE	
DC Forward Current ^[1,2]	2000mA	2400mA
Peak Pulsed Forward Current ^[1,3]	2500mA	2400mA
LED Junction Temperature ^[1] (DC & Pulse)	135°C	120°C
ESD Sensitivity (ANSI/ESDA/JEDEC JS-001-2012)	Class 3B	
Operating Case Temperature ^[1]	-40°C to 135°C	
LED Storage Temperature	-40°C to 135°C	
Soldering Temperature	JEDEC 020c 260°C	
Allowable Reflow Cycles	3	
Reverse Voltage ^[4] (V _{reverse})	LUXEON LEDs are not designed to be driven in reverse bias	

Notes for Table 4:

1. Proper current derating must be observed to maintain the junction temperature below the maximum allowable junction temperature.
2. Residual periodic variations due to power conversion from alternating current (AC) to direct current (DC), also called "ripple," with frequencies ≥100Hz and amplitude ≤15% of the maximum allowable DC forward current are acceptable, assuming the average current throughout each cycle does not exceed the maximum allowable DC forward current at the corresponding maximum junction temperature.
3. Pulsed operation with a peak drive current equal to the stated peak pulsed forward current is acceptable if the pulse on-time is ≤5ms per cycle and the duty cycle is ≤50%.
4. Transient reverse voltages and surge currents due to electrical switching or supply interruptions are acceptable if these events do not last for more than 10ms, the amplitude of the reverse voltage does not exceed 5V and the reverse current is less than 220uA.

Characteristic Curves

Spectral Power Distribution Characteristics

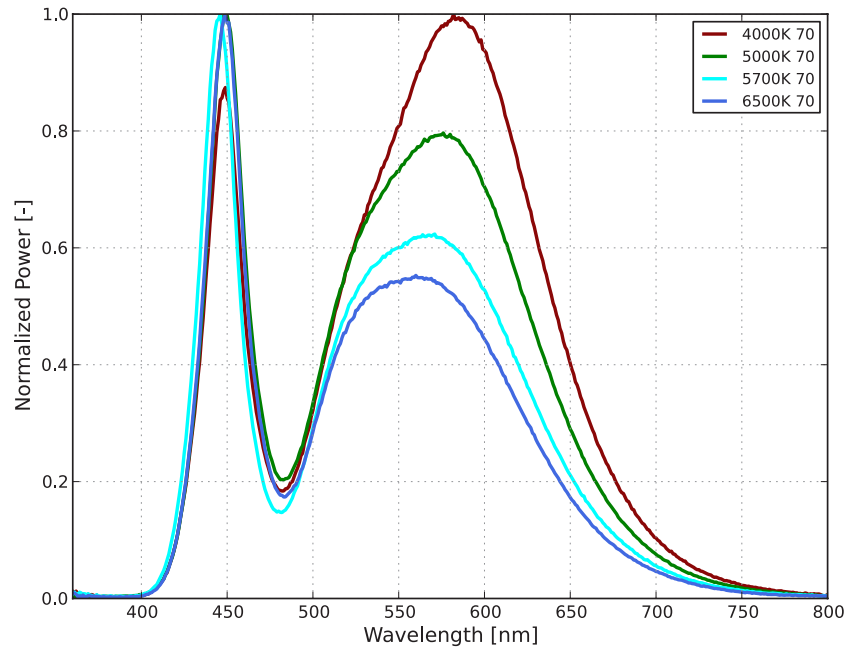

Figure 1. Typical normalized power vs. wavelength for LUXEON V2 at 700mA, $T_j=85^\circ\text{C}$.

Light Output Characteristics

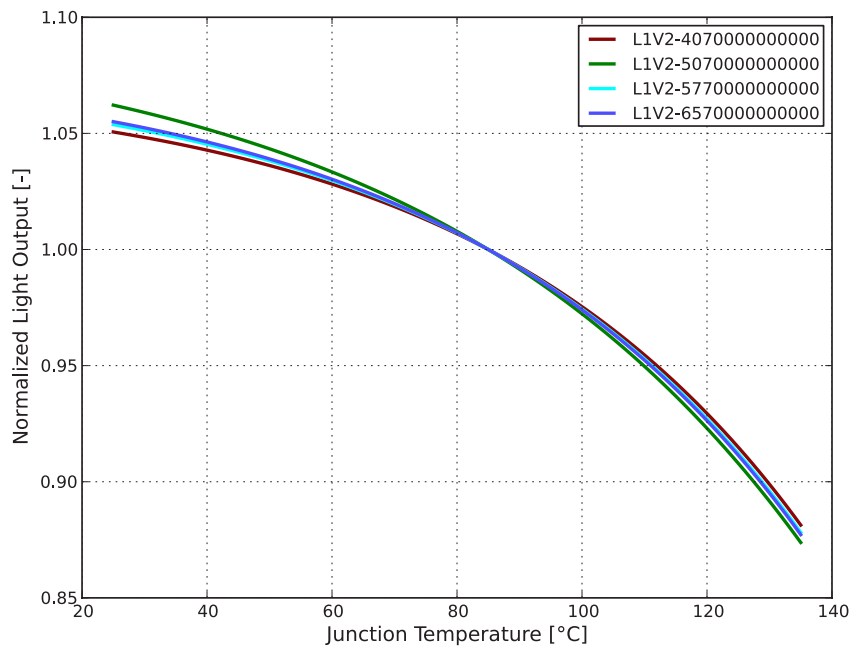

Figure 2. Typical normalized light output vs. junction temperature for LUXEON V2 at 700mA.

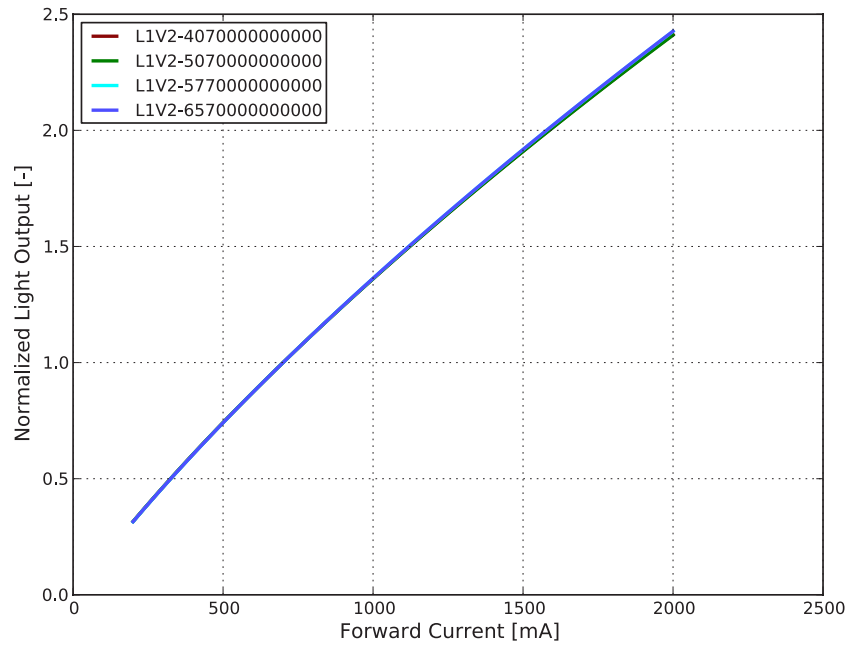

Figure 3. Typical normalized light output vs. forward current for LUXEON V2 at 700mA, $T_j=85^\circ\text{C}$.

Forward Current Characteristics

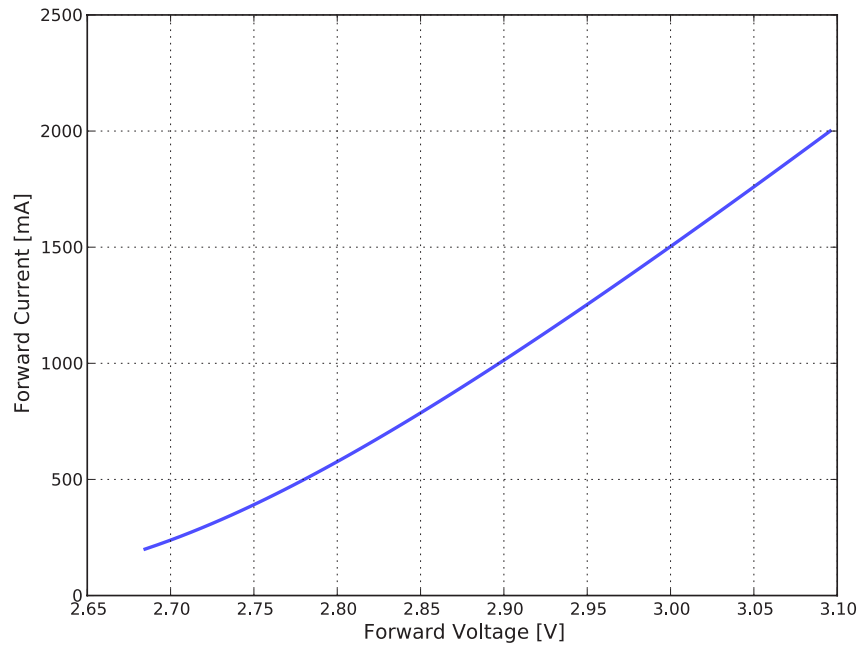

Figure 4. Typical forward current vs. forward voltage for LUXEON V2 at $T_j=85^\circ\text{C}$.

Radiation Pattern Characteristics

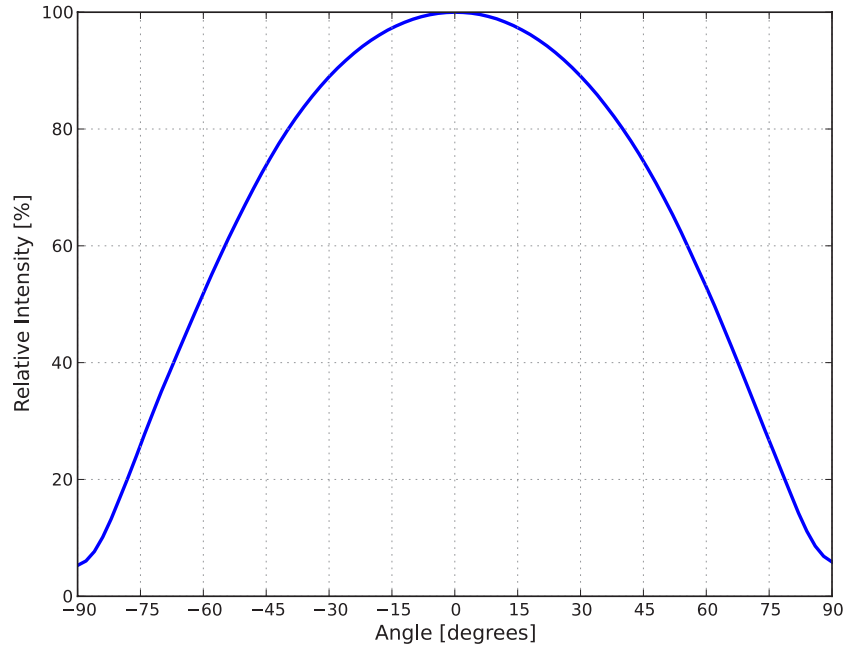

Figure 5. Typical radiation pattern for LUXEON V2 at 700mA, $T_j=85^{\circ}\text{C}$.

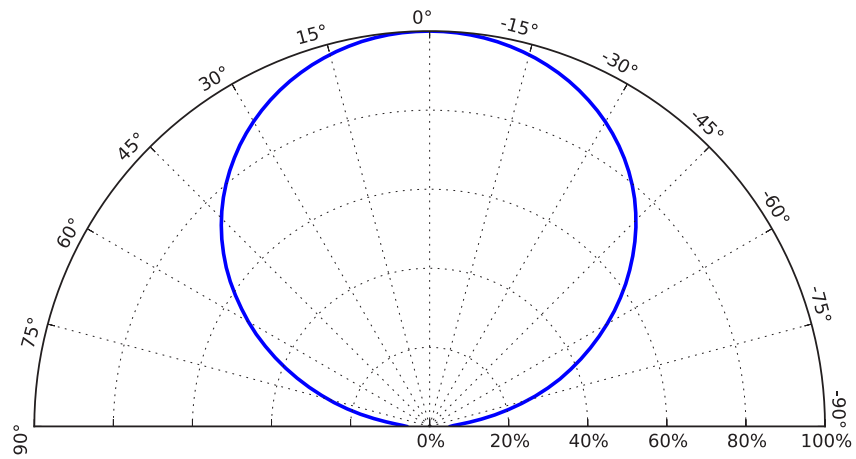

Figure 6. Typical polar radiation pattern for LUXEON V2 at 700mA, $T_j=85^{\circ}\text{C}$.

Product Bin and Labeling Definitions

Decoding Product Bin Labeling

In the manufacturing of semiconductor products, there are variations in performance around the average values given in the technical datasheet. For this reason, Lumileds bins LED components for luminous flux or radiometric power, color point, peak or dominant wavelength and forward voltage.

LUXEON V2 LEDs are labeled using a 4-digit alphanumeric CAT code following the format below:

A B C D

Where:

- A** – designates luminous flux bin (example: V=290 to 300 lumens, W=300 to 310 lumens)
- B C** – designates color bin (example: 80CRI=3L, 3U, 5A, 5B, 5C, 5D and 70CRI=15, 25, 35, 55)
- D** – designates forward voltage bin (example: X=2.65 to 2.85V, Y=2.85 to 3.0V)

Therefore, a LUXEON V2 with a lumen range of 290 to 300, color bin of 5A and a forward voltage range of 2.65 to 2.85V has the following CAT code:

V 5 A X

Luminous Flux Bins

Table 5 lists the standard luminous flux bins for LUXEON V2 emitters. Although several bins are outlined, product availability in a particular bin varies by production run and by product performance. Not all bins are available in all CCTs.

Table 5. Luminous flux bin definitions for LUXEON V2.

BIN	LUMINOUS FLUX ^[1] (lm)	
	MINIMUM	MAXIMUM
R	250	260
S	260	270
T	270	280
U	280	290
V	290	300
W	300	310
X	310	320
Y	320	330
Z	330	340
1	340	350
2	350	360

Notes for Table 5:

1. Lumileds maintains a tolerance of $\pm 6.5\%$ on luminous flux measurements.

Color Bin Definitions

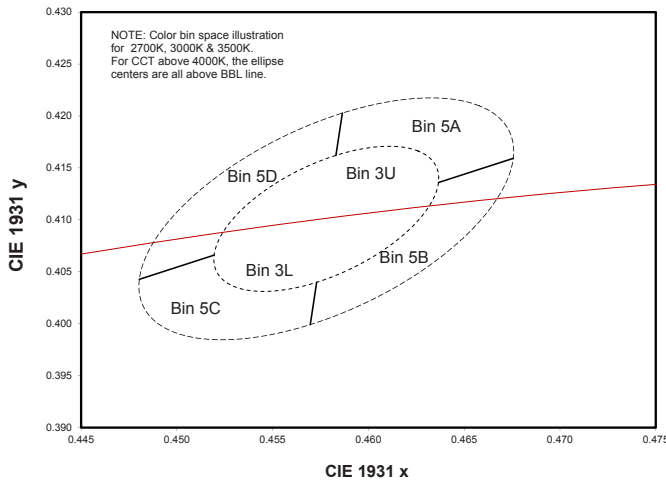

Figure 7. Color space definition for LUXEON V.

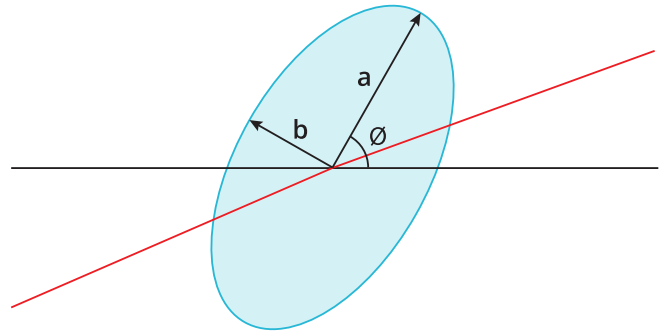

Figure 8. 3- and 5-step MacAdam ellipse illustration for Table 6.

Table 6. 3- and 5-step MacAdam ellipse color bin definitions for LUXEON V2.

NOMINAL CCT	COLOR SPACE	CENTER POINT ^[1] (cx, cy)	MAJOR AXIS, a	MINOR AXIS, b	ELLIPSE ROTATION ANGLE, θ
4000K	Single 3-step MacAdam ellipse	(0.3818, 0.3797)	0.009 390	0.004 020	53.72°
	Single 5-step MacAdam ellipse		0.015 650	0.006 700	
5000K	Single 3-step MacAdam ellipse	(0.3447, 0.3553)	0.008 220	0.003 540	59.62°
	Single 5-step MacAdam ellipse		0.013 700	0.005 900	
5700K	Single 3-step MacAdam ellipse	(0.3287, 0.3417)	0.007 455	0.003 195	59.09°
	Single 5-step MacAdam ellipse		0.012 425	0.005 325	
6500K	Single 3-step MacAdam ellipse	(0.3123, 0.3282)	0.006 690	0.002 850	58.57°
	Single 5-step MacAdam ellipse		0.011 150	0.004 750	

Notes for Table 6:

1. Lumileds maintains a tolerance of ±0.005 on x and y coordinates in the CIE 1931 color space.

Table 7. Correlated color temperature bin definitions for LUXEON V2.

BIN	CCT
1	6500K
2	5700K
3	5000K
5	4000K

Table 8. MacAdam ellipse color bin definitions for LUXEON V2.

BIN	SDCM
3U	3-step MacAdam ellipse
3L	3-step MacAdam ellipse
5	5-step MacAdam ellipse (70CRI)
5A	5-step MacAdam ellipse
5B	5-step MacAdam ellipse
5C	5-step MacAdam ellipse
5D	5-step MacAdam ellipse

Forward Voltage Bins

Table 9. Forward voltage bin definitions for LUXEON V2.

BIN	FORWARD VOLTAGE ⁽¹⁾ (V _f)	
	MINIMUM	MAXIMUM
X	2.65	2.85
Y	2.85	3.00

Notes for Table 9:

1. Lumileds maintains a tolerance of ±0.06V on forward voltage measurements.

Mechanical Dimensions

Notes for Figure 9:

1. Drawings are not to scale.

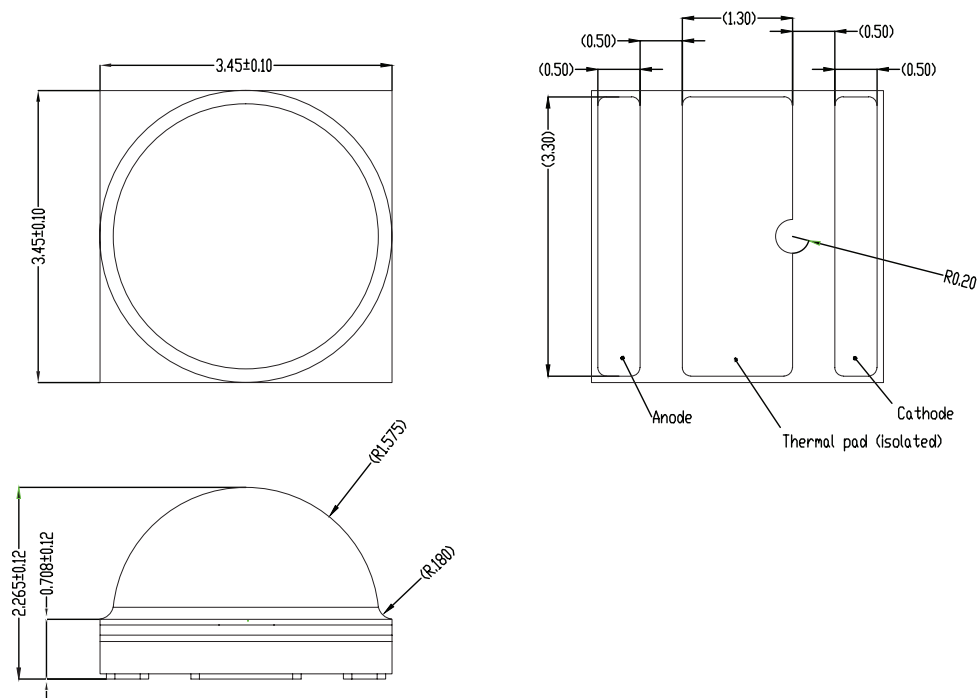

Figure 9. Mechanical dimensions for LUXEON V2.

2. All dimensions are in millimeters.

3. Do not handle the device by the dome. Excessive force on the dome may damage the dome itself or the interior of the device.

Reflow Soldering Guidelines

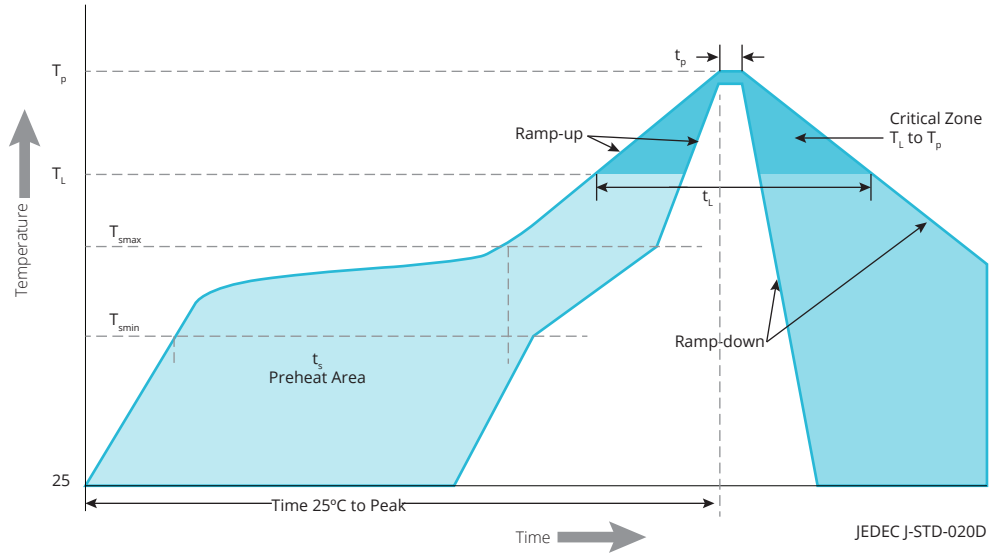

Figure 10. Visualization of the acceptable reflow temperature profile as specified in Table 10.

Table 10. Reflow profile characteristics for LUXEON V2.

PROFILE FEATURE	LEAD-FREE ASSEMBLY
Preheat Minimum Temperature (T_{smin})	150°C
Preheat Maximum Temperature (T_{smax})	200°C
Preheat Time (t_{smin} to t_{smax})	60 to 180 seconds
Ramp-Up Rate (T_L to T_p)	3°C / second maximum
Liquidus Temperature (T_L)	217°C
Time Maintained Above Temperature T_L (t_t)	60 to 150 seconds
Peak / Classification Temperature (T_p)	260°C
Time Within 5°C of Actual Temperature (t_p)	20 to 40 seconds
Ramp-Down Rate (T_p to T_L)	6°C / second maximum
Time 25°C to Peak Temperature	8 minutes maximum

Notes for Table 10:

1. All temperatures refer to the application Printed Circuit Board (PCB), measured on the surface adjacent to the package body.

JEDEC Moisture Sensitivity

Table 11. Moisture sensitivity levels for LUXEON V2.

LEVEL	FLOOR LIFE		SOAK REQUIREMENTS STANDARD	
	TIME	CONDITIONS	TIME	CONDITIONS
1	Unlimited	≤30°C / 85% RH	168 Hours +5 / -0	85°C / 85% RH

Solder Pad Design

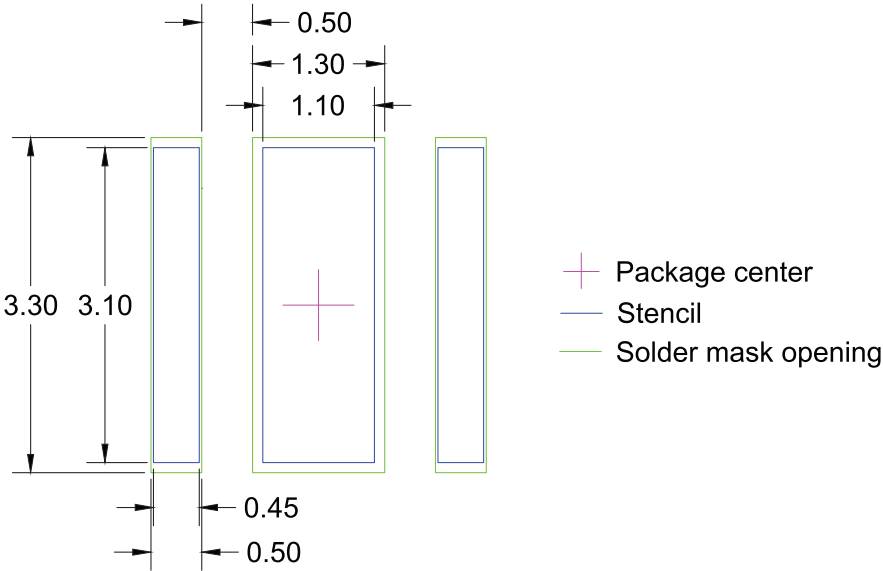

Figure 11. Recommended PCB solder pad layout for LUXEON V2.

- Notes for Figure 11:
- 1. Drawings are not to scale.
 - 2. All dimensions are in millimeters.

Packaging Information

Pocket Tape Dimensions

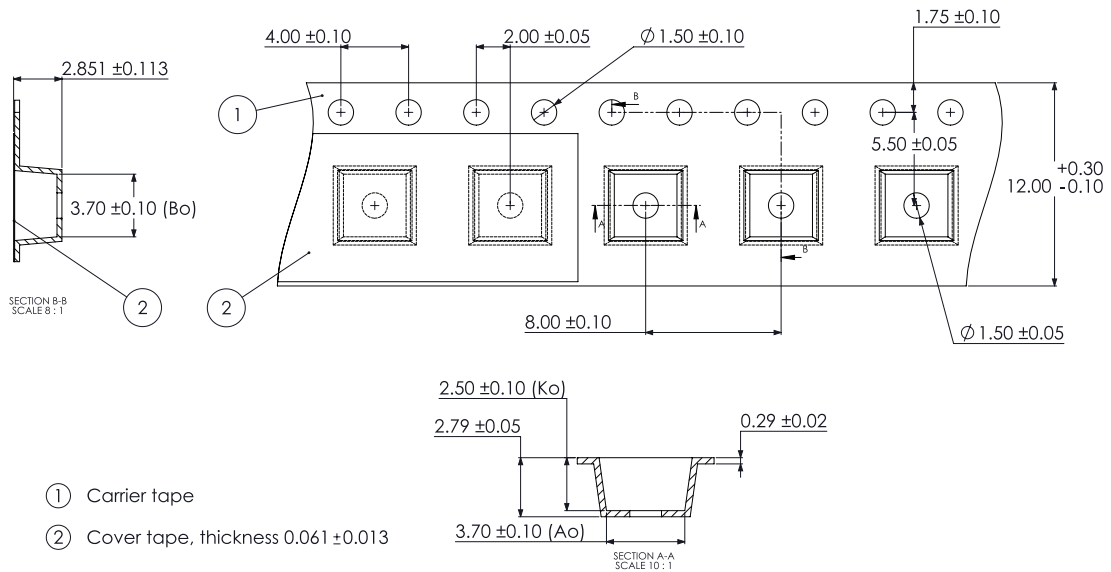

Figure 12. Pocket tape dimensions for LUXEON V2

Notes for Figure 12:

1. Drawings are not to scale.
2. All dimensions are in millimeters.

Reel Dimensions

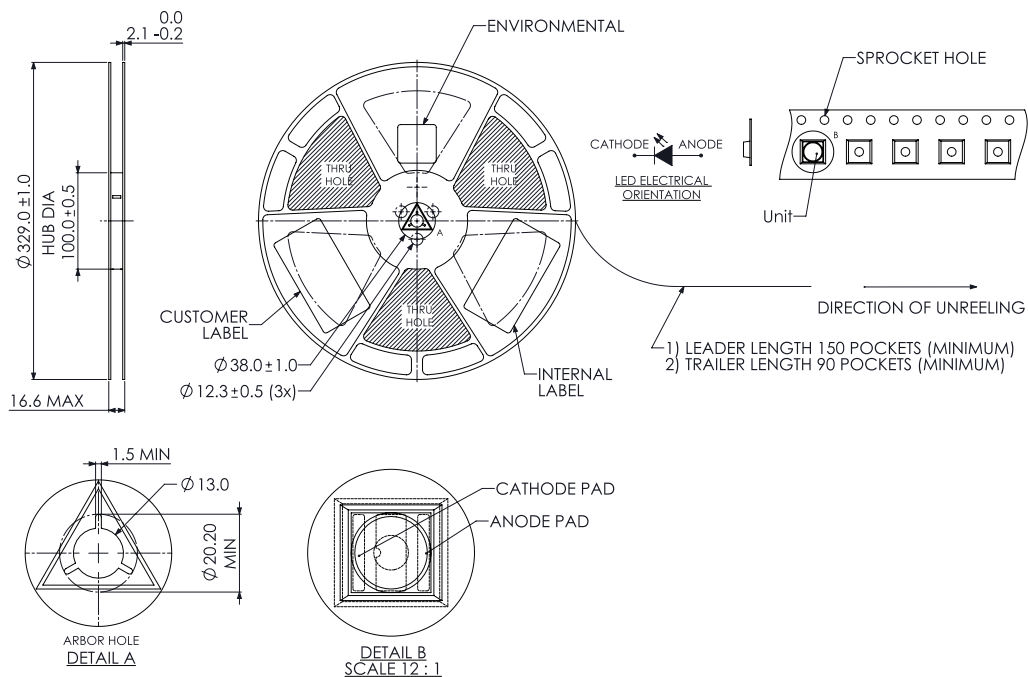

Figure 13. Reel dimensions for LUXEON V2.

Notes for Figure 13:

1. Drawings are not to scale.
2. All dimensions are in millimeters.
3. 2500pcs/reel.

About Lumileds

Companies developing automotive, mobile, IoT and illumination lighting applications need a partner who can collaborate with them to push the boundaries of light. With over 100 years of inventions and industry firsts, Lumileds is a global lighting solutions company that helps customers around the world deliver differentiated solutions to gain and maintain a competitive edge. As the inventor of Xenon technology, a pioneer in halogen lighting and the leader in high performance LEDs, Lumileds builds innovation, quality and reliability into its technology, products and every customer engagement. Together with its customers, Lumileds is making the world better, safer, more beautiful—with light.

To learn more about our lighting solutions, visit lumileds.com.



©2018 Lumileds Holding B.V. All rights reserved.
LUXEON is a registered trademark of the Lumileds Holding B.V. in the United States and other countries.
lumileds.com

Neither Lumileds Holding B.V. nor its affiliates shall be liable for any kind of loss of data or any other damages, direct, indirect or consequential, resulting from the use of the provided information and data. Although Lumileds Holding B.V. and/or its affiliates have attempted to provide the most accurate information and data, the materials and services information and data are provided "as is," and neither Lumileds Holding B.V. nor its affiliates warrants or guarantees the contents and correctness of the provided information and data. Lumileds Holding B.V. and its affiliates reserve the right to make changes without notice. You as user agree to this disclaimer and user agreement with the download or use of the provided materials, information and data. A listing of Lumileds product/patent coverage may be accessed at lumileds.com/patents.



Компания «ЭлектроПласт» предлагает заключение долгосрочных отношений при поставках импортных электронных компонентов на взаимовыгодных условиях!

Наши преимущества:

- Оперативные поставки широкого спектра электронных компонентов отечественного и импортного производства напрямую от производителей и с крупнейших мировых складов;
- Поставка более 17-ти миллионов наименований электронных компонентов;
- Поставка сложных, дефицитных, либо снятых с производства позиций;
- Оперативные сроки поставки под заказ (от 5 рабочих дней);
- Экспресс доставка в любую точку России;
- Техническая поддержка проекта, помощь в подборе аналогов, поставка прототипов;
- Система менеджмента качества сертифицирована по Международному стандарту ISO 9001;
- Лицензия ФСБ на осуществление работ с использованием сведений, составляющих государственную тайну;
- Поставка специализированных компонентов (Xilinx, Altera, Analog Devices, Intersil, Interpoint, Microsemi, Aeroflex, Peregrine, Syfer, Eurofarad, Texas Instrument, Miteq, Cobham, E2V, MA-COM, Hittite, Mini-Circuits, General Dynamics и др.);

Помимо этого, одним из направлений компании «ЭлектроПласт» является направление «Источники питания». Мы предлагаем Вам помощь Конструкторского отдела:

- Подбор оптимального решения, техническое обоснование при выборе компонента;
- Подбор аналогов;
- Консультации по применению компонента;
- Поставка образцов и прототипов;
- Техническая поддержка проекта;
- Защита от снятия компонента с производства.



Как с нами связаться

Телефон: 8 (812) 309 58 32 (многоканальный)

Факс: 8 (812) 320-02-42

Электронная почта: org@eplast1.ru

Адрес: 198099, г. Санкт-Петербург, ул. Калинина, дом 2, корпус 4, литера А.