

### FEATURES

#### High output accuracy

REF01: 10.0 V,  $\pm 0.3\%$  maximum

REF02: 5.0 V,  $\pm 0.3\%$  maximum

REF03: 2.5 V,  $\pm 0.6\%$  maximum

#### Adjustable output: $\pm 3\%$ minimum

#### Excellent temperature stability

REF01: 8.5 ppm/ $^{\circ}\text{C}$  maximum

REF02: 8.5 ppm/ $^{\circ}\text{C}$  maximum

REF03: 50 ppm/ $^{\circ}\text{C}$  maximum

#### Low noise

REF01: 30  $\mu\text{V}$  p-p typical

REF02: 15  $\mu\text{V}$  p-p typical

REF03: 6  $\mu\text{V}$  p-p typical

#### High supply voltage range: up to 36 V maximum

#### Low supply current: 1.4 mA maximum

#### High load-driving capability: 10 mA maximum

#### Temperature output function

### APPLICATIONS

Precision data systems

High resolution converters

Industrial process control systems

Precision instruments

Military and aerospace applications

### GENERAL DESCRIPTION

The REF0x series of precision voltage references provide a stable 10.0 V, 5.0 V, or 2.5 V output with minimal change in response to variations in supply voltage, ambient temperature or load conditions. The parts are available in 8-lead SOIC, PDIP, CERDIP, and TO-99 packages, as well as 20-terminal LCC packages (883 only), furthering the parts' usability in both standard and high stress applications.

With an external buffer and a simple resistor network, the TEMP terminal can be used for temperature sensing and approximation. A TRIM terminal is also provided on the device for fine adjustment of the output voltage.

The small footprint, wide supply range, and application versatility make the REF0x series of references ideal for general-purpose and space-constrained applications.

Newer designs should use the ADR0x series of references, which offer higher accuracy and temperature stability over a wider operating temperature range, while maintaining full pin-for-pin compatibility with the REF0x series. This data sheet applies to commercial-grade products only. Contact sales or visit [analog.com](http://analog.com) for military-grade (883) data sheets.

Table 1. Selection Guide

| Part Number | Output Voltage | Input Voltage Range |
|-------------|----------------|---------------------|
| REF01       | 10.0 V         | 12 V to 36 V        |
| REF02       | 5.0 V          | 7.0 V to 36 V       |
| REF03       | 2.5 V          | 4.5 V to 36 V       |

### PIN CONFIGURATIONS

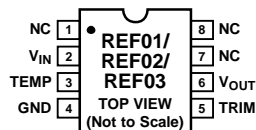

NC = NO CONNECT. DO NOT CONNECT ANYTHING ON THESE PINS. SOME OF THEM ARE RESERVED FOR FACTORY TESTING PURPOSES.

Figure 1. 8-Lead PDIP (P-Suffix),  
8-Lead CERDIP (Z-Suffix),  
8-Lead SOIC (S-Suffix)

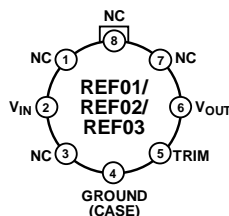

NC = NO CONNECT. DO NOT CONNECT ANYTHING ON THESE PINS. SOME OF THEM ARE RESERVED FOR FACTORY TESTING PURPOSES.

Figure 2. 8-Lead TO-99 (J-Suffix)

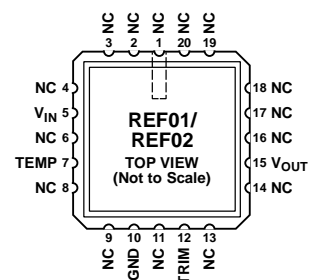

NC = NO CONNECT. DO NOT CONNECT ANYTHING ON THESE PINS. SOME OF THEM ARE RESERVED FOR FACTORY TESTING PURPOSES.

Figure 3. 20-Terminal LCC (RC-Suffix;  
883 Parts Only)

### Rev. K

Information furnished by Analog Devices is believed to be accurate and reliable. However, no responsibility is assumed by Analog Devices for its use, nor for any infringements of patents or other rights of third parties that may result from its use. Specifications subject to change without notice. No license is granted by implication or otherwise under any patent or patent rights of Analog Devices. Trademarks and registered trademarks are the property of their respective owners.

## TABLE OF CONTENTS

|  |    |   |    |
|--|----|---|----|
| Features .....                                     | 1  | Output Adjustment .....                                     | 14 |
| Applications.....                                  | 1  | Temperature Monitoring.....                                 | 15 |
| General Description .....                          | 1  | Long-Term Stability .....                                   | 15 |
| Pin Configurations .....                           | 1  | Burn-In .....   | 15 |
| Revision History .....                             | 2  | Power Dissipation.....                                      | 15 |
| Specifications.....                                | 3  | Applications Information .....                              | 16 |
| REF01 Specifications.....                          | 3  | Basic Reference Application.....                            | 16 |
| REF02 Specifications.....                          | 4  | Low Cost Current Source.....                                | 16 |
| REF03 Specifications.....                          | 5  | Precision Current Source with Adjustable Output .....       | 16 |
| Absolute Maximum Ratings.....                      | 6  | Precision Boosted Output Regulator .....                    | 16 |
| Thermal Resistance .....                           | 6  | Bipolar Voltage Reference .....                             | 17 |
| ESD Caution.....                                   | 6  | Adjustable Reference With Positive and Negative Swing ..... | 17 |
| Pin Configurations and Function Descriptions ..... | 7  | Outline Dimensions.....                                     | 18 |
| Typical Performance Characteristics .....          | 8  | REF01 Ordering Guide.....                                   | 20 |
| Terminology .....                                  | 13 | REF02 Ordering Guide.....                                   | 20 |
| Theory of Operation .....                          | 14 | REF03 Ordering Guide.....                                   | 20 |
| Input and Output Capacitors.....                   | 14 |   |    |

## REVISION HISTORY

### 10/10—Rev. J to Rev. K

|  |    |
|--|----|
| Deleted Negative References Section and Figure 39;<br>Renumbered Sequentially..... | 16 |
|--|----|

### 10/09—Rev. J: Initial Version

|   |           |
|---|-----------|
| Updated Format.....                               | Universal |
| Combined REF01, REF02, and REF03 Data Sheets..... | Universal |
| Changes to Absolute Maximum Input Voltage .....   | 6         |

# SPECIFICATIONS

## REF01 SPECIFICATIONS

$V_{IN} = 15\text{ V}$ ,  $T_A = 25^\circ\text{C}$ ,  $I_{LOAD} = 0\text{ mA}$ , all grades, unless otherwise noted.

| Parameter                            | Symbol                       | Conditions  | Min       | Typ       | Max       | Unit                  |
|--------------------------------------|------------------------------|---|-----------|-----------|-----------|-----------------------|
| OUTPUT VOLTAGE                       | $V_O$                        | A and E grades  | 9.97      | 10.00     | 10.03     | V                     |
|                                      |                              | H grade   | 9.95      | 10.00     | 10.05     | V                     |
|                                      |                              | C grade   | 9.90      | 10.00     | 10.10     | V                     |
| OUTPUT ADJUSTMENT RANGE <sup>1</sup> | $\Delta V_{TRIM}$            | A, E and H grades, POT = 10 k $\Omega$  | $\pm 3.0$ | $\pm 3.3$ |           | %                     |
|                                      |                              | C grade, POT = 10 k $\Omega$  | $\pm 2.7$ | $\pm 3.0$ |           | %                     |
| INITIAL ACCURACY                     | $V_{OERR}$                   | A and E grades  |           |           | $\pm 30$  | mV                    |
|                                      |                              |   |           |           | $\pm 0.3$ | %                     |
|                                      |                              | H grade   |           |           | $\pm 50$  | mV                    |
|                                      |                              |   |           |           | $\pm 0.5$ | %                     |
|                                      |                              | C grade   |           |           | $\pm 100$ | mV                    |
|                                      |                              |   |           | $\pm 1.0$ | %         |                       |
| TEMPERATURE COEFFICIENT              | $TCV_O$                      | A and E grades, $-55^\circ\text{C} \leq T_A \leq +125^\circ\text{C}$  |           | 3.0       | 8.5       | ppm/ $^\circ\text{C}$ |
|                                      |                              | H grade, $0^\circ\text{C} \leq T_A \leq +70^\circ\text{C}$  |           | 10        | 25        | ppm/ $^\circ\text{C}$ |
|                                      |                              | C grade, $0^\circ\text{C} \leq T_A \leq +70^\circ\text{C}$ (-J and -Z packages)   |           | 20        | 65        | ppm/ $^\circ\text{C}$ |
|                                      |                              | C grade, $-40 \leq T_A \leq +85^\circ\text{C}$ (-P and -S packages)   |           | 20        | 65        | ppm/ $^\circ\text{C}$ |
| LINE REGULATION <sup>2</sup>         | $\Delta V_O/\Delta V_{IN}$   | A, E and H grades, $V_{IN} = 13\text{ V to }33\text{ V}$  |           | 60        | 100       | ppm/V                 |
|                                      |                              | A, E and H grades, $V_{IN} = 13\text{ V to }33\text{ V}$ , $0^\circ\text{C} \leq T_A \leq +70^\circ\text{C}$                |           | 70        | 120       | ppm/V                 |
|                                      |                              | A, E and H grades, $V_{IN} = 13\text{ V to }33\text{ V}$ , $-55^\circ\text{C} \leq T_A \leq +125^\circ\text{C}$             |           | 90        | 150       | ppm/V                 |
|                                      |                              | C grade, $V_{IN} = 13\text{ V to }33\text{ V}$  |           | 90        | 150       | ppm/V                 |
|                                      |                              | C grade, $V_{IN} = 13\text{ V to }30\text{ V}$ , $0^\circ\text{C} \leq T_A \leq +70^\circ\text{C}$ (-J and -Z packages)     |           | 110       | 180       | ppm/V                 |
|                                      |                              | C grade, $V_{IN} = 13\text{ V to }30\text{ V}$ , $-40^\circ\text{C} \leq T_A \leq +85^\circ\text{C}$ (-P and -S packages)   |           | 110       | 180       | ppm/V                 |
| LOAD REGULATION <sup>2</sup>         | $\Delta V_O/\Delta I_{LOAD}$ | A and E grades, $I_{LOAD} = 0\text{ mA to }10\text{ mA}$  |           | 50        | 80        | ppm/mA                |
|                                      |                              | A and E grades, $I_{LOAD} = 0\text{ mA to }8\text{ mA}$ , $0^\circ\text{C} \leq T_A \leq +70^\circ\text{C}$                 |           | 60        | 100       | ppm/mA                |
|                                      |                              | A and E grades, $I_{LOAD} = 0\text{ mA to }8\text{ mA}$ , $-55^\circ\text{C} \leq T_A \leq +125^\circ\text{C}$              |           | 90        | 150       | ppm/mA                |
|                                      |                              | H grade, $I_{LOAD} = 0\text{ mA to }10\text{ mA}$   |           | 60        | 100       | ppm/mA                |
|                                      |                              | H grade, $I_{LOAD} = 0\text{ mA to }8\text{ mA}$ , $0^\circ\text{C} \leq T_A \leq +70^\circ\text{C}$                        |           | 70        | 120       | ppm/mA                |
|                                      |                              | H grade, $I_{LOAD} = 0\text{ mA to }8\text{ mA}$ , $-50^\circ\text{C} \leq T_A \leq +125^\circ\text{C}$                     |           | 90        | 150       | ppm/mA                |
|                                      |                              | C grade, $I_{LOAD} = 0\text{ mA to }8\text{ mA}$  |           | 60        | 150       | ppm/mA                |
|                                      |                              | C grade, $I_{LOAD} = 0\text{ mA to }5\text{ mA}$ , $0^\circ\text{C} \leq T_A \leq +70^\circ\text{C}$ (-J and -Z packages)   |           | 80        | 180       | ppm/mA                |
|                                      |                              | C grade, $I_{LOAD} = 0\text{ mA to }5\text{ mA}$ , $-40^\circ\text{C} \leq T_A \leq +85^\circ\text{C}$ (-P and -S packages) |           | 80        | 180       | ppm/mA                |
|                                      |                              | DROPOUT VOLTAGE   | $V_{DO}$  |           |           |                       |
| QUIESCENT CURRENT                    | $I_{IN}$                     | A, E, and H grades  |           | 1.0       | 1.4       | mA                    |
|                                      |                              | C grade   |           | 1.0       | 1.6       | mA                    |
| LOAD CURRENT                         | $I_{LOAD}$                   | A, E, and H grades<br>C grade   |           |           | 10        | mA                    |
|                                      |                              |   |           |           | 8         | mA                    |
|                                      |                              |   |           |           | -0.3      | mA                    |
| SHORT CIRCUIT TO GND                 | $I_{SC}$                     | $V_O = 0\text{ V}$  |           | 30        |           | mA                    |
| VOLTAGE NOISE                        | $e_{N\text{ p-p}}$           | 0.1 Hz to 10.0 Hz (-S, -Z and -P packages)  |           | 30        |           | $\mu\text{V p-p}$     |
|                                      |                              | 0.1 Hz to 10.0 Hz (-J package)  |           | 35        |           | $\mu\text{V p-p}$     |
| LONG-TERM STABILITY <sup>3</sup>     | $\Delta V_O$                 | After 1000 hours of operation   |           | 50        |           | ppm                   |
| TURN-ON SETTLING TIME                | $t_R$                        | Output settling to within $\pm 0.1\%$ of final value  |           | 5         |           | $\mu\text{s}$         |
| TEMPERATURE SENSOR <sup>4</sup>      | $V_{TEMP}$<br>$TCV_{TEMP}$   | Voltage Output at TEMP Pin<br>Temperature Sensitivity   |           | 580       |           | mV                    |
|                                      |                              |   |           | 1.96      |           | mV/ $^\circ\text{C}$  |

<sup>1</sup> Refer to the Output Adjustment section.

<sup>2</sup> Specification includes the effects of self-heating.

<sup>3</sup> Long-term stability is noncumulative; the drift in subsequent 1000-hour periods is significantly lower than in the first 1000-hour periods. Refer to Application Note [AN-713](#).

<sup>4</sup> Refer to the Temperature Monitoring section.

# REF01/REF02/REF03

## REF02 SPECIFICATIONS

$V_{IN} = 15\text{ V}$ ,  $T_A = 25^\circ\text{C}$ ,  $I_{LOAD} = 0\text{ mA}$ , all grades, unless otherwise noted. Nongraded refers to REF02Z.

| Parameter                            | Symbol                       | Conditions  | Min       | Typ       | Max       | Unit                  |
|--------------------------------------|------------------------------|---|-----------|-----------|-----------|-----------------------|
| OUTPUT VOLTAGE                       | $V_O$                        | A and E grades  | 4.985     | 5.000     | 5.015     | V                     |
|                                      |                              | H grade and nongraded   | 4.975     | 5.000     | 5.025     | V                     |
|                                      |                              | C grade   | 4.950     | 5.000     | 5.050     | V                     |
| OUTPUT ADJUSTMENT RANGE <sup>1</sup> | $\Delta V_{TRIM}$            | A, E, H grades and nongraded, POT = 10 k $\Omega$   | $\pm 3.0$ | $\pm 6.0$ |           | %                     |
|                                      |                              | C grade, POT = 10 k $\Omega$  | $\pm 2.7$ | $\pm 6.0$ |           | %                     |
| INITIAL ACCURACY                     | $V_{OERR}$                   | A and E grades  |           |           | $\pm 15$  | mV                    |
|                                      |                              |   |           |           | $\pm 0.3$ | %                     |
|                                      |                              | H grade and nongraded   |           |           | $\pm 25$  | mV                    |
|                                      |                              |   |           |           | $\pm 0.5$ | %                     |
|                                      |                              | C grade   |           |           | $\pm 50$  | mV                    |
|                                      |                              |   |           |           | $\pm 1$   | %                     |
| TEMPERATURE COEFFICIENT              | $TCV_O$                      | A grade and non-graded, $-55^\circ\text{C} \leq T_A \leq +125^\circ\text{C}$  |           | 3         | 8.5       | ppm/ $^\circ\text{C}$ |
|                                      |                              | E and H grades, $0^\circ\text{C} \leq T_A \leq +70^\circ\text{C}$   |           | 10        | 25        | ppm/ $^\circ\text{C}$ |
|                                      |                              | C grade, $0^\circ\text{C} \leq T_A \leq +70^\circ\text{C}$ (-J and -Z packages)   |           | 20        | 65        | ppm/ $^\circ\text{C}$ |
|                                      |                              | C grade, $-40 \leq T_A \leq +85^\circ\text{C}$ (-P and -S packages)   |           | 20        | 65        | ppm/ $^\circ\text{C}$ |
|                                      |                              |   |           |           |           |                       |
| LINE REGULATION <sup>2</sup>         | $\Delta V_O/\Delta V_{IN}$   | A, E, H grades and nongraded, $V_{IN} = 8\text{ V to }36\text{ V}$  |           | 60        | 100       | ppm/V                 |
|                                      |                              | A, E, H grades and nongraded, $V_{IN} = 8\text{ V to }36\text{ V}$ , $0^\circ\text{C} \leq T_A \leq +70^\circ\text{C}$      |           | 70        | 120       | ppm/V                 |
|                                      |                              | A, E, H grades and nongraded, $V_{IN} = 8\text{ V to }36\text{ V}$ , $-55^\circ\text{C} \leq T_A \leq +125^\circ\text{C}$   |           | 90        | 150       | ppm/V                 |
|                                      |                              | C grade, $V_{IN} = 8\text{ V to }36\text{ V}$   |           | 90        | 150       | ppm/V                 |
|                                      |                              | C grade, $V_{IN} = 8\text{ V to }36\text{ V}$ , $0^\circ\text{C} \leq T_A \leq +70^\circ\text{C}$ (-J and -Z packages)      |           | 110       | 180       | ppm/V                 |
|                                      |                              | C grade, $V_{IN} = 8\text{ V to }36\text{ V}$ , $-40^\circ\text{C} \leq T_A \leq +85^\circ\text{C}$ (-P and -S packages)    |           | 110       | 180       | ppm/V                 |
|                                      |                              |   |           |           |           |                       |
| LOAD REGULATION <sup>2</sup>         | $\Delta V_O/\Delta I_{LOAD}$ | A and E grades, $I_{LOAD} = 0\text{ mA to }10\text{ mA}$  |           | 60        | 100       | ppm/mA                |
|                                      |                              | A and E grades, $I_{LOAD} = 0\text{ mA to }8\text{ mA}$ , $0^\circ\text{C} \leq T_A \leq +70^\circ\text{C}$                 |           | 60        | 100       | ppm/mA                |
|                                      |                              | A and E grades, $I_{LOAD} = 0\text{ mA to }8\text{ mA}$ , $-55^\circ\text{C} \leq T_A \leq +125^\circ\text{C}$              |           | 70        | 120       | ppm/mA                |
|                                      |                              | H grade and nongraded, $I_{LOAD} = 0\text{ mA to }10\text{ mA}$   |           | 60        | 100       | ppm/mA                |
|                                      |                              | H grade and nongraded, $I_{LOAD} = 0\text{ mA to }8\text{ mA}$ , $0^\circ\text{C} \leq T_A \leq +70^\circ\text{C}$          |           | 70        | 120       | ppm/mA                |
|                                      |                              | H grade and nongraded, $I_{LOAD} = 0\text{ mA to }8\text{ mA}$ , $-50^\circ\text{C} \leq T_A \leq +125^\circ\text{C}$       |           | 90        | 150       | ppm/mA                |
|                                      |                              | C grade, $I_{LOAD} = 0\text{ mA to }8\text{ mA}$  |           | 60        | 150       | ppm/mA                |
|                                      |                              | C grade, $I_{LOAD} = 0\text{ mA to }5\text{ mA}$ , $0^\circ\text{C} \leq T_A \leq +70^\circ\text{C}$ (-J and -Z packages)   |           | 80        | 180       | ppm/mA                |
|                                      |                              | C grade, $I_{LOAD} = 0\text{ mA to }5\text{ mA}$ , $-40^\circ\text{C} \leq T_A \leq +85^\circ\text{C}$ (-P and -S packages) |           | 80        | 180       | ppm/mA                |
|                                      |                              |   |           |           |           |                       |
| DROPOUT VOLTAGE                      | $V_{DO}$                     |   |           |           | 2         | V                     |
| QUIESCENT CURRENT                    | $I_{IN}$                     | A, E, H grades and nongraded  |           | 1.0       | 1.4       | mA                    |
|                                      |                              | C grade   |           | 1.0       | 1.6       | mA                    |
| LOAD CURRENT                         | $I_{LOAD}$                   | Sourcing  |           |           | 10        | mA                    |
|                                      |                              | Sinking   |           |           | 8         | mA                    |
|                                      |                              |   |           |           | -0.3      | mA                    |
| SHORT CIRCUIT TO GND                 | $I_{SC}$                     | $V_O = 0\text{ V}$  |           | 30        |           | mA                    |
| VOLTAGE NOISE                        | $e_{N\text{-P-P}}$           | 0.1 Hz to 10.0 Hz (-S, -Z and -P packages)  |           | 15        |           | $\mu\text{V p-p}$     |
|                                      |                              | 0.1 Hz to 10.0 Hz (-J package)  |           | 20        |           | $\mu\text{V p-p}$     |
| LONG-TERM STABILITY <sup>3</sup>     | $\Delta V_O$                 | After 1000 hours of operation   |           | 50        |           | ppm                   |
| TURN-ON SETTLING TIME                | $t_R$                        | Output settling to within $\pm 0.1\%$ of final value  |           | 5         |           | $\mu\text{s}$         |
| TEMPERATURE SENSOR <sup>4</sup>      | $V_{TEMP}$<br>$TCV_{TEMP}$   | Voltage Output at TEMP Pin  |           | 580       |           | mV                    |
|                                      |                              | Temperature Sensitivity   |           | 1.96      |           | mV/ $^\circ\text{C}$  |

<sup>1</sup> Refer to the Output Adjustment section.

<sup>2</sup> Specification includes the effects of self-heating.

<sup>3</sup> Long-term stability is noncumulative; the drift in subsequent 1000-hour periods is significantly lower than in the first 1000-hour periods. Refer to Application Note [AN-713](#).

<sup>4</sup> Refer to the Temperature Monitoring section.

**REF03 SPECIFICATIONS**

$V_{IN} = 15\text{ V}$ ,  $-40^{\circ}\text{C} \leq T_A \leq +85^{\circ}\text{C}$ ,  $I_{LOAD} = 0\text{ mA}$ , unless otherwise noted.

| Parameter                            | Symbol                       | Conditions   | Min     | Typ      | Max                   | Unit                    |
|--------------------------------------|------------------------------|--|---------|----------|-----------------------|-------------------------|
| OUTPUT VOLTAGE                       | $V_O$                        |  | 2.495   | 2.500    | 2.515                 | V                       |
| OUTPUT ADJUSTMENT RANGE <sup>1</sup> | $\Delta V_{TRIM}$            | POT = 10 k $\Omega$                                  | $\pm 6$ | $\pm 11$ |                       | %                       |
| INITIAL ACCURACY                     | $V_{OERR}$                   |  |         |          | $\pm 15$<br>$\pm 0.6$ | mV<br>%                 |
| TEMPERATURE COEFFICIENT              | $TCV_O$                      |  |         | 10       | 50                    | ppm/ $^{\circ}\text{C}$ |
| LINE REGULATION <sup>2</sup>         | $\Delta V_O/\Delta V_{IN}$   | $V_{IN} = 4.5\text{ V to }33\text{ V}$               |         | 20       | 50                    | ppm/V                   |
| LOAD REGULATION <sup>2</sup>         | $\Delta V_O/\Delta I_{LOAD}$ | $I_{LOAD} = 0\text{ mA to }10\text{ mA}$             |         | 60       | 100                   | ppm/mA                  |
| DROPOUT VOLTAGE                      | $V_{DO}$                     |  |         |          | 2                     | V                       |
| QUIESCENT CURRENT                    | $I_{IN}$                     |  |         | 1.0      | 1.4                   | mA                      |
| LOAD CURRENT                         | $I_{LOAD}$                   |  |         |          |                       |                         |
| Sourcing                             |                              |  |         |          | 10                    | mA                      |
| Sinking                              |                              |  |         |          | -0.3                  | mA                      |
| SHORT CIRCUIT TO GND                 | $I_{SC}$                     | $V_O = 0\text{ V}$                                   |         | 24       |                       | mA                      |
| VOLTAGE NOISE                        | $e_{N\text{ p-p}}$           | 0.1 Hz to 10.0 Hz                                    |         | 6        |                       | $\mu\text{V p-p}$       |
| LONG-TERM STABILITY <sup>3</sup>     | $\Delta V_O$                 | After 1000 hours of operation                        |         | 50       |                       | ppm                     |
| TURN-ON SETTLING TIME                | $t_R$                        | Output settling to within $\pm 0.1\%$ of final value |         | 5        |                       | $\mu\text{s}$           |
| TEMPERATURE SENSOR <sup>4</sup>      |                              |  |         |          |                       |                         |
| Voltage Output at TEMP Pin           | $V_{TEMP}$                   |  |         | 580      |                       | mV                      |
| Temperature Sensitivity              | $TCV_{TEMP}$                 |  |         | 1.96     |                       | mV/ $^{\circ}\text{C}$  |

<sup>1</sup> Refer to the Output Adjustment section.

<sup>2</sup> Specification includes the effects of self-heating.

<sup>3</sup> Long-term stability is noncumulative; the drift in subsequent 1000-hour periods is significantly lower than in the first 1000-hour periods. Refer to Application Note [AN-713](#).

<sup>4</sup> Refer to the Temperature Monitoring section.

# REF01/REF02/REF03

## ABSOLUTE MAXIMUM RATINGS

Table 2.

| Parameter  | Rating          |
|--|-----------------|
| Input Voltage  | 36.0 V          |
| Output Short Circuit Duration  | Indefinite      |
| Operating Temperature Range  |                 |
| REF01A, REF02A   | -55°C to +125°C |
| REF01CP, REF01CS, REF01E, REF01H,<br>REF02CP, REF02CS, REF02E, REF02H,<br>REF03G | -40°C to +85°C  |
| REF01CJ  | 0°C to +70°C    |
| Storage Temperature Range  |                 |
| -J, -S, -Z and -RC Packages  | -65°C to +150°C |
| -P Package   | -65°C to +125°C |
| Junction Temperature Range (T <sub>J</sub> )                                     | -65°C to +150°C |
| Lead Temperature (Soldering, 10 sec.)  | 300°C           |

Stresses above those listed under Absolute Maximum Ratings may cause permanent damage to the device. This is a stress rating only; functional operation of the device at these or any other conditions above those indicated in the operational section of this specification is not implied. Exposure to absolute maximum rating conditions for extended periods may affect device reliability.

## THERMAL RESISTANCE

$\theta_{JA}$  is specified for the worst-case conditions, that is, a device soldered in a circuit board for surface-mount packages.

Table 3. Thermal Resistance

| Package Type      | $\theta_{JA}$ | $\theta_{JC}$ | Unit |
|-------------------|---------------|---------------|------|
| 8-lead SOIC (S)   | 130           | 43            | °C/W |
| 8-lead PDIP (P)   | 110           | 50            | °C/W |
| 8-lead CERDIP (Z) | 162           | 26            | °C/W |
| TO-99 (J)         | 170           | 24            | °C/W |

## ESD CAUTION



**ESD (electrostatic discharge) sensitive device.** Charged devices and circuit boards can discharge without detection. Although this product features patented or proprietary protection circuitry, damage may occur on devices subjected to high energy ESD. Therefore, proper ESD precautions should be taken to avoid performance degradation or loss of functionality.

## PIN CONFIGURATIONS AND FUNCTION DESCRIPTIONS



Figure 4. 8-Lead PDIP (P-Suffix), 8-Lead CERDIP (Z-Suffix), 8-Lead SOIC (S-Suffix) Pin Configuration

Table 4. Pin Function Descriptions—PDIP, CERDIP, and SOIC Packages

| Pin No. | Mnemonic         | Description   |
|---------|------------------|---|
| 1, 7, 8 | NC               | No Internal Connection. Leave floating or tied to ground in actual application. |
| 2       | V <sub>IN</sub>  | Supply Voltage Input.   |
| 3       | TEMP             | Temperature (Band Gap) Output. Refer to the Temperature Monitoring section.     |
| 4       | GND              | Ground Connection.  |
| 5       | TRIM             | Output Voltage Trim. Refer to the Output Adjustment section.                    |
| 6       | V <sub>OUT</sub> | Reference Voltage Output.   |

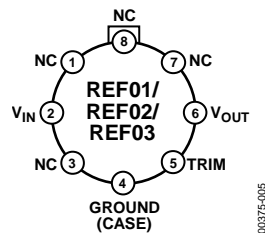

Figure 5. 8-Lead TO-99 (J-Suffix) Pin Configuration

Table 5. Pin Function Descriptions—8-Lead TO-99 Package

| Pin No.    | Mnemonic         | Description   |
|------------|------------------|---|
| 1, 3, 7, 8 | NC               | No Internal Connection. Leave floating or tied to ground in actual application. |
| 2          | V <sub>IN</sub>  | Supply Voltage Input.   |
| 4          | GND              | Ground Connection.  |
| 5          | TRIM             | Output Voltage Trim. Refer to the Output Adjustment section.                    |
| 6          | V <sub>OUT</sub> | Reference Voltage Output.   |

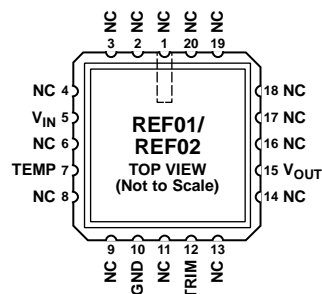

Figure 6. 20-Terminal LCC (RC-Suffix) Pin Configuration

Table 6. Pin Function Descriptions—20-Terminal LCC Package

| Terminal No.                          | Mnemonic         | Description   |
|---------------------------------------|------------------|---|
| 1 to 4, 6, 8, 9, 11, 13, 14, 16 to 20 | NC               | No Internal Connection. Leave floating or tied to ground in actual application. |
| 5                                     | V <sub>IN</sub>  | Supply Voltage Input.   |
| 7                                     | TEMP             | Temperature (Band Gap) Output. Refer to the Temperature Monitoring section.     |
| 10                                    | GND              | Ground Connection.  |
| 12                                    | TRIM             | Output Voltage Trim. Refer to the Output Adjustment section.                    |
| 15                                    | V <sub>OUT</sub> | Reference Voltage Output.   |

TYPICAL PERFORMANCE CHARACTERISTICS



Figure 7. REF01 Typical Output Voltage vs. Temperature



Figure 10. REF01 Supply Current vs. Input Voltage



Figure 8. REF02 Typical Output Voltage vs. Temperature



Figure 11. REF02 Supply Current vs. Input Voltage



Figure 9. REF03 Typical Output Voltage vs. Temperature



Figure 12. REF03 Supply Current vs. Input Voltage





Figure 13. REF01 Load Regulation vs. Temperature



Figure 16. REF01 Line Regulation vs. Temperature



Figure 14. REF02 Load Regulation vs. Temperature



Figure 17. REF02 Line Regulation vs. Temperature



Figure 15. REF03 Load Regulation vs. Temperature



Figure 18. REF03 Line Regulation vs. Temperature

# REF01/REF02/REF03



Figure 19. REF01 Dropout Voltage vs. Load Current



Figure 22. REF01 Quiescent Current vs. Load Current



Figure 20. REF02 Dropout Voltage vs. Load Current



Figure 23. REF02 Typical Low-Frequency Voltage Noise (0.1 Hz to 10.0 Hz)



Figure 21. REF03 Dropout Voltage vs. Load Current



Figure 24. REF02 Typical Wideband Voltage Noise (10 Hz to 10 kHz)



Figure 25. REF02 Line Transient Response

00375-025



Figure 28. REF02 Turn-Off Response

00375-028

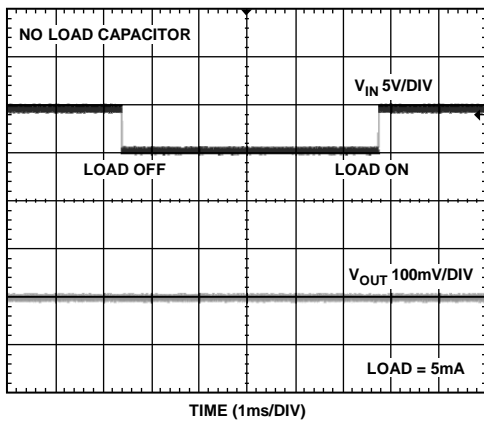

Figure 26. REF02 Load Transient Response

00375-026



Figure 29. REF02 Turn-On Response

00375-029

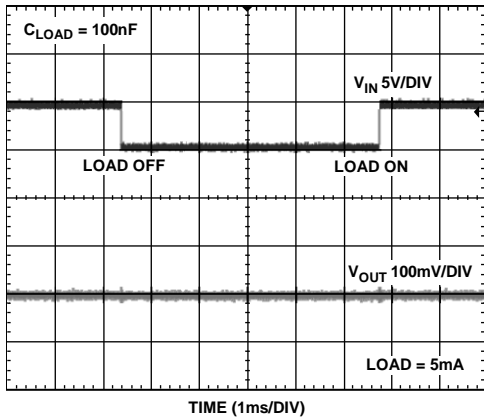

Figure 27. REF02 Load Transient Response

00375-027



Figure 30. REF02 Turn-Off Response (No Input Capacitor)

00375-030

# REF01/REF02/REF03

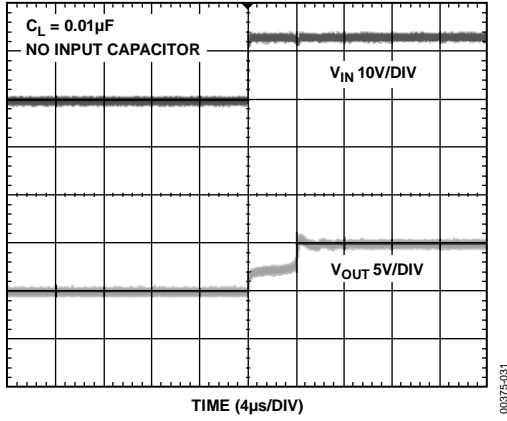

Figure 31. REF02 Turn-Off Response (No Input Capacitor)

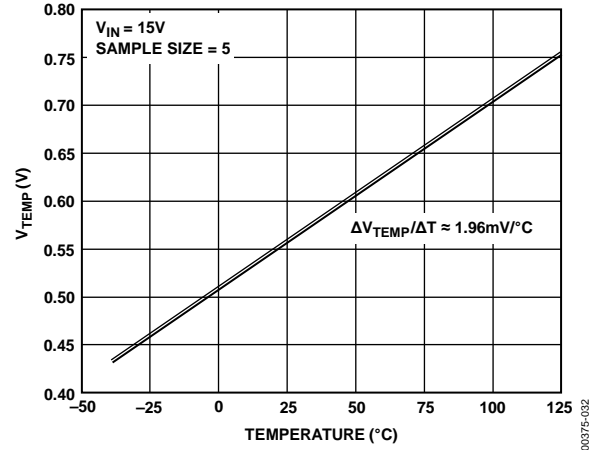

Figure 32. Output Voltage at TEMP Pin vs. Temperature

## TERMINOLOGY

### Dropout Voltage ( $V_{DO}$ )

Dropout voltage, sometimes referred to as supply voltage headroom or supply-output voltage differential, is defined as the minimum voltage differential between the input and output necessary for the device to operate.

$$V_{DO} = (V_{IN} - V_{OUT})_{\min} \Big|_{I_L = \text{constant}}$$

Since the dropout voltage depends upon the current passing through the device, it is always specified for a given load current.

### Temperature Coefficient ( $TCV_O$ )

The temperature coefficient relates the change in output voltage to the change in ambient temperature of the device, as normalized by the output voltage at 25°C. This parameter is expressed in ppm/°C and can be determined by the following equation:

$$TCV_{OUT} = \frac{V_{OUT}(T_2) - V_{OUT}(T_1)}{V_{OUT}(25^\circ\text{C}) \times (T_2 - T_1)} \times 10^6 \text{ [ppm/}^\circ\text{C]}$$

where:

$V_{OUT}(25^\circ\text{C})$  is output voltage at 25°C.

$V_{OUT}(T_1)$  is output voltage at temperature 1.

$V_{OUT}(T_2)$  is output voltage at temperature 2.

### Thermally Induced Output Voltage Hysteresis ( $\Delta V_{OUT\_HYS}$ )

Thermally induced output voltage hysteresis represents the change in output voltage after the device is exposed to a specified temperature cycle. This may be expressed as either a shift in voltage or a difference in ppm from the nominal output.

$$V_{OUT\_HYS} = V_{OUT}(25^\circ\text{C}) - V_{OUT\_TC} \text{ [V]}$$

$$V_{OUT\_HYS} = \frac{V_{OUT}(25^\circ\text{C}) - V_{OUT\_TC}}{V_{OUT}(25^\circ\text{C})} \times 10^6 \text{ [ppm]}$$

where:

$V_{OUT}(25^\circ\text{C})$  is output voltage at 25°C.

$V_{OUT\_TC}$  is output voltage after temperature cycling.

Thermal hysteresis occurs mainly as a result of forces exhibited upon the internal die by its packaging. The effect is more pronounced in parts with smaller packages.

### Long-Term Stability ( $\Delta V_{OUT\_LTD}$ )

Long-term stability refers to the shift in output voltage at 25°C after 1000 hours of operation in a 25°C environment. This may also be expressed as either a shift in voltage or a difference in ppm from the nominal output.

$$\Delta V_{OUT\_LTD} = |V_{OUT}(t_1) - V_{OUT}(t_0)| \text{ [V]}$$

$$\Delta V_{OUT\_LTD} = \left| \frac{V_{OUT}(t_1) - V_{OUT}(t_0)}{V_{OUT}(t_0)} \right| \times 10^6 \text{ [ppm]}$$

where:

$V_{OUT}(t_0)$  is  $V_{OUT}$  at 25°C at time 0.

$V_{OUT}(t_1)$  is  $V_{OUT}$  at 25°C after 1000 hours of operation at 25°C.

### Line Regulation

Line regulation refers to the change in output voltage in response to a given change in input voltage. It is expressed in either percent per volt, ppm per volt, or microvolt per volt change in input voltage. This parameter accounts for the effects of self-heating.

### Load Regulation

Load regulation refers to the change in output voltage in response to a given change in load current, and is expressed in either microvolts per milliamp, ppm per milliamp, or ohms of DC output resistance. This parameter accounts for the effects of self-heating.

# REF01/REF02/REF03

## THEORY OF OPERATION

REF01, REF02, and REF03 are high precision, low drift 10.0 V, 5.0 V, and 2.5 V voltage references available in a variety of packages. These devices are standard band gap references (see Figure 33). The band gap cell contains two NPN transistors (Q18 and Q19) that differ in emitter area by a factor of 2. The difference in the  $V_{BE}$  values of these transistors produces a proportional-to-absolute temperature current (PTAT) through R14, and, when combined with the  $V_{BE}$  of Q19, produces a band gap voltage,  $V_{BG}$ , that is almost constant over temperature.

With an internal op amp and the feedback network created by R5 and R6,  $V_O$  is set precisely at 10.0 V, 5.0 V, or 2.5 V. Precision laser trimming of various resistors and other proprietary circuit techniques are used to further enhance the initial accuracy, temperature curvature, and drift performance of the device.

The PTAT voltage is brought out directly from the band gap, unbuffered, at the TEMP pin. Since this voltage output has a stable 1.96 mV/°C temperature coefficient, users can estimate the temperature change of the device by simply monitoring the change in voltage at this pin.



Figure 33. REF0x Simplified Schematic

## INPUT AND OUTPUT CAPACITORS

Figure 34 shows the basic input/output capacitor configuration for the REF0x series of references.

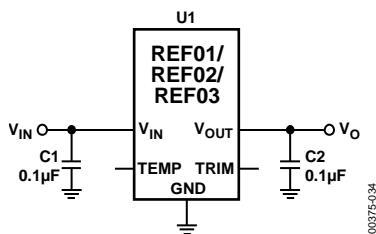

Figure 34. Basic REF0x Capacitor Configuration

While the REF0x series of references are designed to function stably without any external components, connecting a 0.1 µF ceramic capacitor to the output is highly recommended to improve stability and filter out low level voltage noise. An additional 1 µF to 10 µF electrolytic, tantalum, or ceramic capacitor can be added in parallel to improve transient performance in response to sudden changes in load current; however, the designer should keep in mind that doing so increases the turn-on time of the device.

A 1 µF to 10 µF electrolytic, tantalum, or ceramic capacitor can also be connected to the input to improve transient response in applications where the supply voltage may fluctuate. An additional 0.1 µF ceramic capacitor should be connected in parallel to reduce supply noise.

Both input and output capacitors should be mounted as close to the device pins as possible.

## OUTPUT ADJUSTMENT

The REF0x trim terminal can be used to adjust the output up or down from the internally trimmed, nominal output voltage. This feature allows the system designer to trim out system errors due to changes in line and load conditions, thermal hysteresis, output offset due to solder reflow, or other error sources. The basic trim circuit configuration is shown in Figure 35.

Table 7 also lists the range of output voltages obtainable from each model in this configuration.

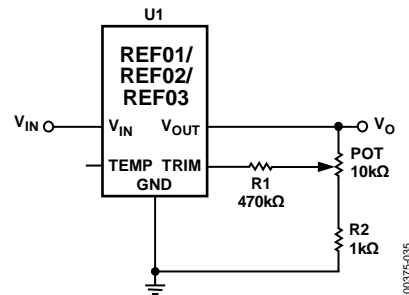

Figure 35. Optional Trim Adjustment Circuit

Table 7. Adjustment Range Using Trim Circuit

| Model | $V_{OUT}$ , Low Limit | $V_{OUT}$ , High Limit |
|-------|-----------------------|------------------------|
| REF01 | 9.70 V                | 10.05 V                |
| REF02 | 4.95 V                | 5.02 V                 |
| REF03 | 2.3 V                 | 2.8 V                  |

Adjustment of the output does not significantly affect the temperature performance of the reference itself, provided the temperature coefficients of the resistors used are low.

## TEMPERATURE MONITORING

In addition to the optional TRIM function, the REF0x series of references provides the ability to monitor changes in temperature by way of tracking the voltage present at the TEMP pin. The output voltage of this pin is taken directly from the band gap core and, as a result, varies linearly with temperature. The nominal voltage at the TEMP pin ( $V_{TEMP}$ ) is approximately 550 mV at 25°C, with a temperature coefficient ( $TCV_{TEMP}$ ) of approximately 1.96 mV/°C. Refer to Figure 32 for a graph of output voltage vs. temperature.

As an example, given these ideal values, a voltage change of 39.2 mV at the TEMP pin corresponds to a 20°C change in temperature.

The TEMP function is provided as a convenience, rather than a precise feature, of the reference. In addition, because the voltage at the TEMP pin is taken directly from the band gap core, any current injected into or pulled from this pin has a significant effect on  $V_{OUT}$ . As such, even tens of microamps drawn from the TEMP pin can cause the output to fall out of regulation. Should the designer wish to take advantage of this feature, it is necessary to buffer the output of the TEMP pin with a low bias current op amp, such as the AD8601 or AD8641. Any of these op amps, if used as shown in Figure 36, causes less than a 100  $\mu$ V change in  $V_{OUT}$ .

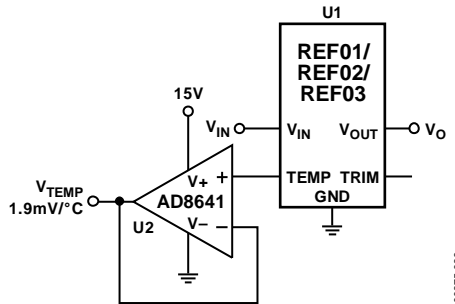

Figure 36. Temperature Monitoring

## LONG-TERM STABILITY

One of the key parameters of the REF0x series of references is long-term stability. Regardless of output voltage, internal testing during development showed a typical drift of approximately 50 ppm after 1,000 hours of continuous, nonloaded operation in a +25°C environment.

It is important to understand that long-term stability is not guaranteed by design, and that the output from the device may shift beyond the typical 50 ppm specification at any time, especially during the first 200 hours of operation. For systems that require highly stable output over long periods of time, the designer should consider burning-in the devices prior to use to minimize the amount of output drift exhibited by the reference over time. Refer to the AN-713 Application Note for more information regarding the effects of long-term drift and how it can be minimized.

## BURN-IN

Burn-in, wherein the part is powered and allowed to operate normally for an extended period of time, can be useful for minimizing the effects of long-term drift. A sample burn-in circuit is shown below in Figure 37.



Figure 37. Burn-In Circuit

The part may be burned in with or without a constant resistive load. The load current should not exceed 10 mA.

## POWER DISSIPATION

The REF0x series of voltage references are capable of sourcing up to 10 mA of load current at room temperature across the rated input voltage range. However, when used in applications subject to high ambient temperatures, the input voltage and load current should be carefully monitored to ensure that the device does not exceed its maximum power dissipation rating. The maximum power dissipation of the device can be calculated via the following equation:

$$P_D = \frac{T_j - T_A}{\theta_{JA}} [W]$$

where:

$P_D$  is device power dissipation.

$T_j$  is device junction temperature.

$T_A$  is ambient temperature.

$\theta_{JA}$  is package (junction-to-air) thermal resistance.

Because of this relationship, acceptable load current in high-temperature conditions may be less than the maximum current-sourcing capability of the device. In no case should the part be operated outside of its maximum power rating as doing so may result in premature failure or permanent damage to the device.

# REF01/REF02/REF03

## APPLICATIONS INFORMATION

### BASIC REFERENCE APPLICATION

Figure 38 shows the basic configuration for any REF0x device. Input and output capacitance values can be tailored for performance, provided they follow the guidelines described in the Input and Output Capacitors section.



Figure 38. Basic Reference Application

### LOW COST CURRENT SOURCE

Unlike most references, the quiescent current of the REF0x series remains constant with respect to the load current (refer to Figure 22). As a result, a simple, low cost current source can be constructed by configuring the reference as shown in Figure 39.

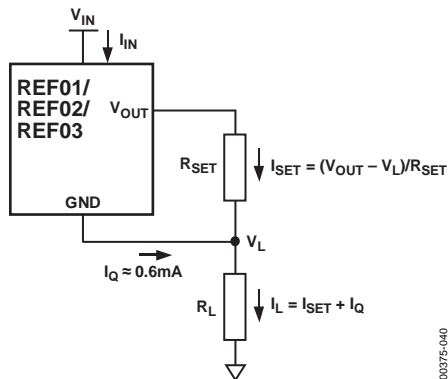

Figure 39. Simple Current Source

In this configuration, the current through the resistor  $R_{SET}$  ( $I_{SET}$ ) is equal to  $(V_{OUT} - V_L)/R_{SET}$ .  $I_L$  is simply the sum of  $I_{SET}$  and  $I_Q$ . However, since  $I_Q$  typically varies from 0.55 mA to 0.65 mA, this circuit should be limited to low precision, general-purpose applications.

### PRECISION CURRENT SOURCE WITH ADJUSTABLE OUTPUT

A higher-precision current source can be implemented with the circuit shown in Figure 40.



Figure 40. Programmable 0 mA to 5 mA Current Source

By adding a mechanical or digital potentiometer, this circuit becomes an adjustable current source. If a digital potentiometer is used, the load current is simply the voltage across terminal B to terminal W of the digital potentiometer divided by the value of the resistor  $R_{SET}$ .

$$I_L = \frac{V_{REF} \times D}{R_{SET}} [A]$$

where  $D$  is the decimal equivalent of the digital potentiometer input code.

A dual-supply op amp should be used since the ground potential of REF02 can swing from  $-5.0$  V to  $V_L$  while the potentiometer is swung from zero-scale to full-scale.

### PRECISION BOOSTED OUTPUT REGULATOR

The output current sourcing capability of the REF0x series can be boosted by using an external op amp and MOSFET, as shown in Figure 41.



Figure 41. Precision Boosted Output Regulator

In this circuit, U2 forces  $V_O$  to  $V_{REF}$  by regulating the current through N1, thereby sourcing the load current directly from the input voltage source connected at  $V_{IN}$ . Using the components shown, this circuit can source up to 50 mA with an input voltage of 15.0 V. The circuit's current sourcing capability can be further increased by replacing N1 with a higher-power MOSFET.



## BIPOLAR VOLTAGE REFERENCE

Many applications require both a positive and reference voltage of the same magnitude. A simple method of generating such a bipolar reference is shown in Figure 42.



Figure 42. Bipolar Voltage Reference

In this configuration, the negative rail is generated simply with an inverting amplifier with a gain of  $-1$ . A low offset op amp should be used to minimize the voltage error at the negative output.

## ADJUSTABLE REFERENCE WITH POSITIVE AND NEGATIVE SWING

The output voltage of the REF0x references can be readily adjusted via a simple trim circuit (explained in the Output Adjustment section). The circuit shown in Figure 43 extends the negative range of adjustment beyond that obtainable with the simple trim circuit by employing a precision op amp with a potentiometer feeding the op amp's noninverting input.



Figure 43. Negatively Adjustable Reference

The voltage output from the op amp can be adjusted by changing the value of the potentiometer: as shown, the op amp outputs  $+2.5$  V when the pot is pulled completely high, and  $-2.5$  V when pulled completely low. In this configuration, the load current is sourced by the op amp; therefore, a low offset op amp with a current rating that meets or exceeds the current requirements of the load should be used.

OUTLINE DIMENSIONS



CONTROLLING DIMENSIONS ARE IN INCHES; MILLIMETER DIMENSIONS (IN PARENTHESES) ARE ROUNDED-OFF INCH EQUIVALENTS FOR REFERENCE ONLY AND ARE NOT APPROPRIATE FOR USE IN DESIGN.

Figure 44. 8-Lead Ceramic Dual In-Line Package [CERDIP]  
Z-Suffix (Q-8)  
Dimensions shown in inches and (millimeters)

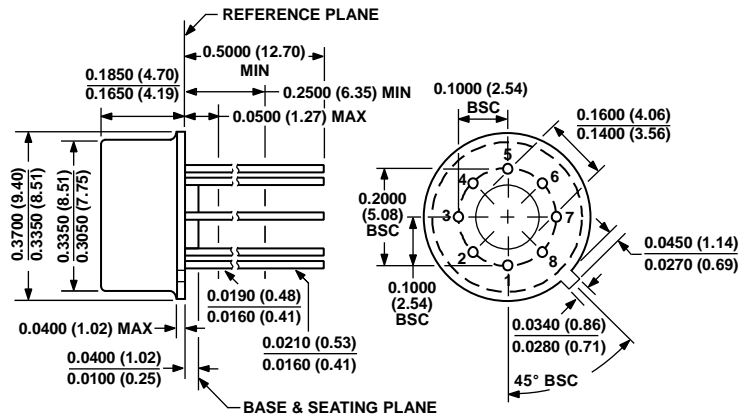

COMPLIANT TO JEDEC STANDARDS MO-002-AK  
CONTROLLING DIMENSIONS ARE IN INCHES; MILLIMETER DIMENSIONS (IN PARENTHESES) ARE ROUNDED-OFF INCH EQUIVALENTS FOR REFERENCE ONLY AND ARE NOT APPROPRIATE FOR USE IN DESIGN.

Figure 45. 8-Pin Metal Header Package [TO-99]  
J-Suffix (H-08)  
Dimensions shown in inches and (millimeters)

022306-A



COMPLIANT TO JEDEC STANDARDS MS-001  
 CONTROLLING DIMENSIONS ARE IN INCHES; MILLIMETER DIMENSIONS (IN PARENTHESES) ARE ROUNDED-OFF INCH EQUIVALENTS FOR REFERENCE ONLY AND ARE NOT APPROPRIATE FOR USE IN DESIGN. CORNER LEADS MAY BE CONFIGURED AS WHOLE OR HALF LEADS.

Figure 46. 8-Lead Plastic Dual In-Line Package [PDIP]  
 Narrow Body, P-Suffix (N-8)  
 Dimensions shown in inches and (millimeters)

070606-A



CONTROLLING DIMENSIONS ARE IN INCHES; MILLIMETER DIMENSIONS (IN PARENTHESES) ARE ROUNDED-OFF INCH EQUIVALENTS FOR REFERENCE ONLY AND ARE NOT APPROPRIATE FOR USE IN DESIGN.

Figure 47. 20-Terminal Ceramic Leadless Chip Carrier [LCC]  
 RC-Suffix (E-20-1)  
 Dimensions shown in inches and (millimeters)

022106-A



COMPLIANT TO JEDEC STANDARDS MS-012-A A  
 CONTROLLING DIMENSIONS ARE IN MILLIMETERS; INCH DIMENSIONS (IN PARENTHESES) ARE ROUNDED-OFF MILLIMETER EQUIVALENTS FOR REFERENCE ONLY AND ARE NOT APPROPRIATE FOR USE IN DESIGN.

Figure 48. 8-Lead Standard Small Outline Package [SOIC\_N]  
 Narrow Body, S-Suffix (R-8)  
 Dimensions shown in millimeters and (inches)

012407-A

# REF01/REF02/REF03

## REF01 ORDERING GUIDE

| Model <sup>1, 2</sup> | Initial Accuracy (mV) | Temperature Range | Package Description | Package Option  |
|-----------------------|-----------------------|-------------------|---------------------|-----------------|
| REF01AJ/883C          | ±30                   | −55°C to +125°C   | 8-Pin TO-99         | J-Suffix (H-08) |
| REF01CJ               | ±100                  | 0°C to 70°C       | 8-Pin TO-99         | J-Suffix (H-08) |
| REF01EZ               | ±30                   | −40°C to +85°C    | 8-Lead CERDIP       | Z-Suffix (Q-8)  |
| REF01HZ               | ±50                   | −40°C to +85°C    | 8-Lead CERDIP       | Z-Suffix (Q-8)  |
| REF01CPZ              | ±100                  | −40°C to +85°C    | 8-Lead PDIP         | P-Suffix (N-8)  |
| REF01HPZ              | ±50                   | −40°C to +85°C    | 8-Lead PDIP         | P-Suffix (N-8)  |
| REF01CS               | ±100                  | −40°C to +85°C    | 8-Lead SOIC_N       | S-Suffix (R-8)  |
| REF01CS-REEL          | ±100                  | −40°C to +85°C    | 8-Lead SOIC_N       | S-Suffix (R-8)  |
| REF01CS-REEL7         | ±100                  | −40°C to +85°C    | 8-Lead SOIC_N       | S-Suffix (R-8)  |
| REF01CSZ              | ±100                  | −40°C to +85°C    | 8-Lead SOIC_N       | S-Suffix (R-8)  |
| REF01CSZ-REEL         | ±100                  | −40°C to +85°C    | 8-Lead SOIC_N       | S-Suffix (R-8)  |
| REF01CSZ-REEL7        | ±100                  | −40°C to +85°C    | 8-Lead SOIC_N       | S-Suffix (R-8)  |

<sup>1</sup> Contact sales for 883 data sheet.

<sup>2</sup> Z = RoHS Compliant Part.

## REF02 ORDERING GUIDE

| Model <sup>1, 2</sup> | Initial Accuracy (mV) | Temperature Range | Package Description | Package Option     |
|-----------------------|-----------------------|-------------------|---------------------|--------------------|
| REF02AJ/883C          | ±15                   | −55°C to +125°C   | 8-Pin TO-99         | J-Suffix (H-08)    |
| REF02AZ               | ±15                   | −55°C to +125°C   | 8-Lead CERDIP       | Z-Suffix (Q-8)     |
| REF02AZ/883C          | ±15                   | −55°C to +125°C   | 8-Lead CERDIP       | Z-Suffix (Q-8)     |
| REF02CP               | ±50                   | −40°C to +85°C    | 8-Lead PDIP         | P-Suffix (N-8)     |
| REF02CPZ              | ±50                   | −40°C to +85°C    | 8-Lead PDIP         | P-Suffix (N-8)     |
| REF02CS               | ±50                   | −40°C to +85°C    | 8-Lead SOIC_N       | S-Suffix (R-8)     |
| REF02CS-REEL          | ±50                   | −40°C to +85°C    | 8-Lead SOIC_N       | S-Suffix (R-8)     |
| REF02CS-REEL7         | ±50                   | −40°C to +85°C    | 8-Lead SOIC_N       | S-Suffix (R-8)     |
| REF02CSZ              | ±50                   | −40°C to +85°C    | 8-Lead SOIC_N       | S-Suffix (R-8)     |
| REF02CSZ-REEL         | ±50                   | −40°C to +85°C    | 8-Lead SOIC_N       | S-Suffix (R-8)     |
| REF02CSZ-REEL7        | ±50                   | −40°C to +85°C    | 8-Lead SOIC_N       | S-Suffix (R-8)     |
| REF02EZ               | ±15                   | −40°C to +85°C    | 8-Lead CERDIP       | Z-Suffix (Q-8)     |
| REF02HZ               | ±25                   | −40°C to +85°C    | 8-Lead CERDIP       | Z-Suffix (Q-8)     |
| REF02HPZ              | ±25                   | −40°C to +85°C    | 8-Lead PDIP         | P-Suffix (N-8)     |
| REF02HSZ              | ±25                   | −40°C to +85°C    | 8-Lead SOIC_N       | S-Suffix (R-8)     |
| REF02RC/883           | ±25                   | −55°C to +125°C   | 20-Terminal LCC     | RC-Suffix (E-20-1) |
| REF02Z                | ±25                   | −55°C to +125°C   | 8-Lead CERDIP       | Z-Suffix (Q-8)     |

<sup>1</sup> Contact sales for 883 data sheet.

<sup>2</sup> Z = RoHS Compliant Part.

## REF03 ORDERING GUIDE

| Model <sup>1</sup> | Initial Accuracy (mV) | Temperature Range | Package Description | Package Option |
|--------------------|-----------------------|-------------------|---------------------|----------------|
| REF03GPZ           | ±15                   | −40°C to +85°C    | 8-Lead PDIP         | N-8 (P-Suffix) |
| REF03GSZ           | ±15                   | −40°C to +85°C    | 8-Lead SOIC_N       | R-8 (P-Suffix) |
| REF03GSZ-REEL      | ±15                   | −40°C to +85°C    | 8-Lead SOIC_N       | R-8 (P-Suffix) |
| REF03GSZ-REEL7     | ±15                   | −40°C to +85°C    | 8-Lead SOIC_N       | R-8 (P-Suffix) |

<sup>1</sup> Z = RoHS Compliant Part.



Компания «ЭлектроПласт» предлагает заключение долгосрочных отношений при поставках импортных электронных компонентов на взаимовыгодных условиях!

Наши преимущества:

- Оперативные поставки широкого спектра электронных компонентов отечественного и импортного производства напрямую от производителей и с крупнейших мировых складов;
- Поставка более 17-ти миллионов наименований электронных компонентов;
- Поставка сложных, дефицитных, либо снятых с производства позиций;
- Оперативные сроки поставки под заказ (от 5 рабочих дней);
- Экспресс доставка в любую точку России;
- Техническая поддержка проекта, помощь в подборе аналогов, поставка прототипов;
- Система менеджмента качества сертифицирована по Международному стандарту ISO 9001;
- Лицензия ФСБ на осуществление работ с использованием сведений, составляющих государственную тайну;
- Поставка специализированных компонентов (Xilinx, Altera, Analog Devices, Intersil, Interpoint, Microsemi, Aeroflex, Peregrine, Syfer, Eurofarad, Texas Instrument, Miteq, Cobham, E2V, MA-COM, Hittite, Mini-Circuits, General Dynamics и др.);

Помимо этого, одним из направлений компании «ЭлектроПласт» является направление «Источники питания». Мы предлагаем Вам помощь Конструкторского отдела:

- Подбор оптимального решения, техническое обоснование при выборе компонента;
- Подбор аналогов;
- Консультации по применению компонента;
- Поставка образцов и прототипов;
- Техническая поддержка проекта;
- Защита от снятия компонента с производства.



#### Как с нами связаться

**Телефон:** 8 (812) 309 58 32 (многоканальный)

**Факс:** 8 (812) 320-02-42

**Электронная почта:** [org@eplast1.ru](mailto:org@eplast1.ru)

**Адрес:** 198099, г. Санкт-Петербург, ул. Калинина, дом 2, корпус 4, литера А.