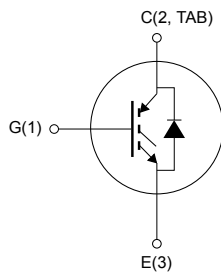
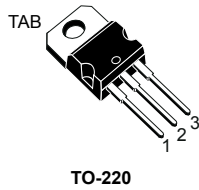


## Trench gate field-stop, 650 V, 20 A, M series low-loss IGBT



NG1E3C2T



## Features

- High short-circuit withstand time
- $V_{CE(sat)} = 1.55 \text{ V (typ.) @ } I_C = 20 \text{ A}$
- Tight parameters distribution
- Safer paralleling
- Low thermal resistance
- Soft and very fast recovery antiparallel diode

## Applications

- Motor control
- UPS
- PFC
- General-purpose inverters

## Description

This device is an IGBT developed using an advanced proprietary trench gate field-stop structure. The device is part of the M series IGBTs, which represent an optimal balance between inverter system performance and efficiency where the low-loss and the short-circuit functionality is essential. Furthermore, the positive  $V_{CE(sat)}$  temperature coefficient and the tight parameter distribution result in safer paralleling operation.

## Product status link

[STGP20M65DF2](#)

## Product summary

Order code	STGP20M65DF2
Marking	G20M65DF2
Package	TO-220
Packing	Tube

# 1 Electrical ratings

**Table 1. Absolute maximum ratings**

Symbol	Parameter	Value	Unit
$V_{CES}$	Collector-emitter voltage ( $V_{GE} = 0$ )	650	V
$I_C$	Continuous collector current at $T_C = 25\text{ °C}$	40	A
	Continuous collector current at $T_C = 100\text{ °C}$	20	A
$I_{CP}^{(1)}$	Pulsed collector current	80	A
$V_{GE}$	Gate-emitter voltage	$\pm 20$	V
$I_F$	Continuous forward current at $T_C = 25\text{ °C}$	40	A
	Continuous forward current at $T_C = 100\text{ °C}$	20	A
$I_{FP}^{(1)}$	Pulsed forward current	80	A
$P_{TOT}$	Total dissipation at $T_C = 25\text{ °C}$	166	W
$T_{STG}$	Storage temperature range	-55 to 150	°C
$T_J$	Operating junction temperature range	-55 to 175	°C

1. Pulse width limited by maximum junction temperature.

**Table 2. Thermal data**

Symbol	Parameter	Value	Unit
$R_{thJC}$	Thermal resistance junction-case IGBT	0.9	°C/W
$R_{thJC}$	Thermal resistance junction-case diode	2.08	°C/W
$R_{thJA}$	Thermal resistance junction-ambient	62.5	°C/W

## 2 Electrical characteristics

$T_C = 25\text{ °C}$  unless otherwise specified

**Table 3. Static characteristics**

Symbol	Parameter	Test conditions	Min.	Typ.	Max.	Unit
$V_{(BR)CES}$	Collector-emitter breakdown voltage	$V_{GE} = 0\text{ V}, I_C = 250\text{ }\mu\text{A}$	650			V
$V_{CE(sat)}$	Collector-emitter saturation voltage	$V_{GE} = 15\text{ V}, I_C = 20\text{ A}$		1.55	2.0	V
		$V_{GE} = 15\text{ V}, I_C = 20\text{ A}, T_J = 125\text{ °C}$		1.95		
		$V_{GE} = 15\text{ V}, I_C = 20\text{ A}, T_J = 175\text{ °C}$		2.1		
$V_F$	Forward on-voltage	$I_F = 20\text{ A}$		1.85		V
		$I_F = 20\text{ A}, T_J = 125\text{ °C}$		1.65		
		$I_F = 20\text{ A}, T_J = 175\text{ °C}$		1.55		
$V_{GE(th)}$	Gate threshold voltage	$V_{CE} = V_{GE}, I_C = 500\text{ }\mu\text{A}$	5	6	7	V
$I_{CES}$	Collector cut-off current	$V_{GE} = 0\text{ V}, V_{CE} = 650\text{ V}$			25	$\mu\text{A}$
$I_{GES}$	Gate-emitter leakage current	$V_{CE} = 0\text{ V}, V_{GE} = \pm 20\text{ V}$			250	nA

**Table 4. Dynamic characteristics**

Symbol	Parameter	Test conditions	Min.	Typ.	Max.	Unit
$C_{ies}$	Input capacitance	$V_{CE} = 25\text{ V}, f = 1\text{ MHz}, V_{GE} = 0\text{ V}$	-	1688	-	pF
$C_{oes}$	Output capacitance		-	95	-	
$C_{res}$	Reverse transfer capacitance		-	35	-	
$Q_g$	Total gate charge	$V_{CC} = 520\text{ V}, I_C = 20\text{ A},$	-	63	-	nC
$Q_{ge}$	Gate-emitter charge	$V_{GE} = 0\text{ to }15\text{ V}$	-	15	-	
$Q_{gc}$	Gate-collector charge	(see Figure 29. Gate charge test circuit)	-	26	-	

**Table 5. IGBT switching characteristics (inductive load)**

Symbol	Parameter	Test conditions	Min.	Typ.	Max.	Unit
$t_{d(on)}$	Turn-on delay time	$V_{CE} = 400\text{ V}$ , $I_C = 20\text{ A}$ , $V_{GE} = 15\text{ V}$ , $R_G = 12\ \Omega$ (see Figure 28. Test circuit for inductive load switching)		26	-	ns
$t_r$	Current rise time			10.8	-	ns
$(di/dt)_{on}$	Turn-on current slope			1409	-	A/ $\mu$ s
$t_{d(off)}$	Turn-off delay time			108	-	ns
$t_f$	Current fall time			65	-	ns
$E_{on}^{(1)}$	Turn-on switching energy			0.14	-	mJ
$E_{off}^{(2)}$	Turn-off switching energy			0.56	-	mJ
$E_{ts}$	Total switching energy			0.7	-	mJ
$t_{d(on)}$	Turn-on delay time		$V_{CE} = 400\text{ V}$ , $I_C = 20\text{ A}$ , $V_{GE} = 15\text{ V}$ , $R_G = 12\ \Omega$ , $T_J = 175\text{ }^\circ\text{C}$ (see Figure 28. Test circuit for inductive load switching)		28.4	-
$t_r$	Current rise time			11.2	-	ns
$(di/dt)_{on}$	Turn-on current slope			1393	-	A/ $\mu$ s
$t_{d(off)}$	Turn-off delay time			107	-	ns
$t_f$	Current fall time			145	-	ns
$E_{on}^{(1)}$	Turn-on switching energy			0.3	-	mJ
$E_{off}^{(2)}$	Turn-off switching energy			0.85	-	mJ
$E_{ts}$	Total switching energy			1.15	-	mJ
$t_{sc}$	Short-circuit withstand time	$V_{CC} = 400\text{ V}$ , $V_{GE} = 13\text{ V}$ , $T_{Jstart} = 150\text{ }^\circ\text{C}$		10		-
		$V_{CC} = 400\text{ V}$ , $V_{GE} = 15\text{ V}$ , $T_{Jstart} = 150\text{ }^\circ\text{C}$	6		-	

1. Including the reverse recovery of the diode.

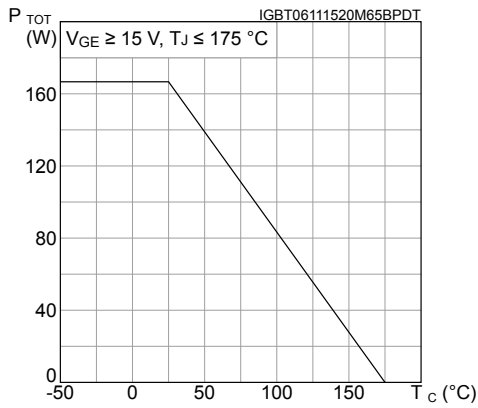
2. Including the tail of the collector current.

**Table 6. Diode switching characteristics (inductive load)**

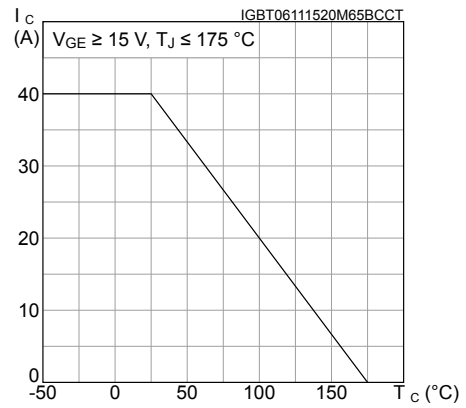
Symbol	Parameter	Test conditions	Min.	Typ.	Max.	Unit	
$t_{rr}$	Reverse recovery time	$I_F = 20\text{ A}$ , $V_R = 400\text{ V}$ , $V_{GE} = 15\text{ V}$ , $di/dt = 1000\text{ A}/\mu\text{s}$ (see Figure 28. Test circuit for inductive load switching)	-	166		ns	
$Q_{rr}$	Reverse recovery charge			-	690		nC
$I_{rrm}$	Reverse recovery current			-	13.2		A
$dI_{rr}/dt$	Peak rate of fall of reverse recovery current during $t_b$			-	769		A/ $\mu$ s
$E_{rr}$	Reverse recovery energy			-	81		$\mu$ J
$t_{rr}$	Reverse recovery time	$I_F = 20\text{ A}$ , $V_R = 400\text{ V}$ , $V_{GE} = 15\text{ V}$ , $T_J = 175\text{ }^\circ\text{C}$ , $di/dt = 1000\text{ A}/\mu\text{s}$ (see Figure 28. Test circuit for inductive load switching)	-	281		ns	
$Q_{rr}$	Reverse recovery charge			-	2010		nC
$I_{rrm}$	Reverse recovery current			-	19.6		A
$dI_{rr}/dt$	Peak rate of fall of reverse recovery current during $t_b$			-	370		A/ $\mu$ s
$E_{rr}$	Reverse recovery energy			-	215		$\mu$ J

## 2.1 Electrical characteristics (curves)

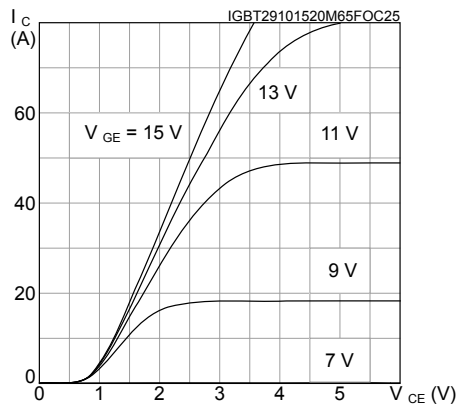
**Figure 1. Power dissipation vs case temperature**



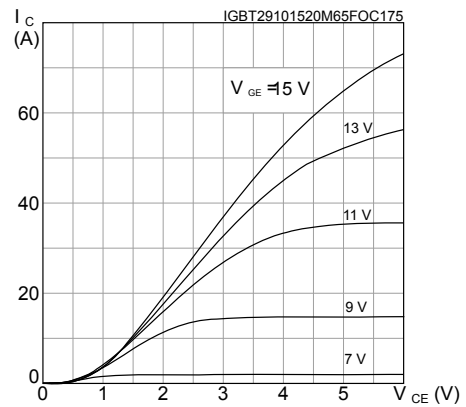
**Figure 2. Collector current vs case temperature**



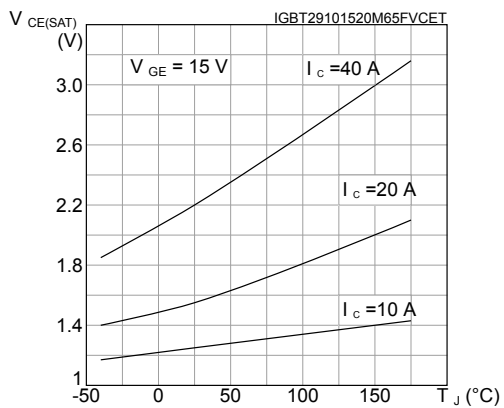
**Figure 3. Output characteristics ( $T_J = 25\text{ °C}$ )**



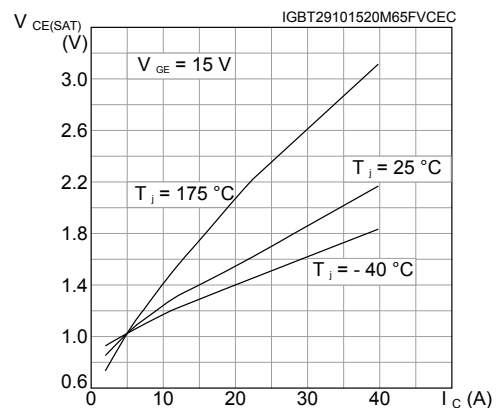
**Figure 4. Output characteristics ( $T_J = 175\text{ °C}$ )**



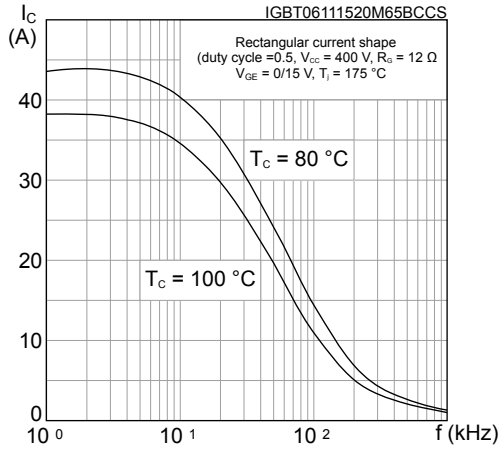
**Figure 5.  $V_{CE(sat)}$  vs junction temperature**



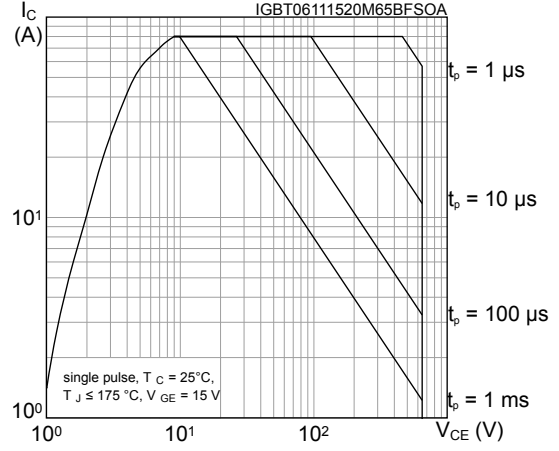
**Figure 6.  $V_{CE(sat)}$  vs collector current**



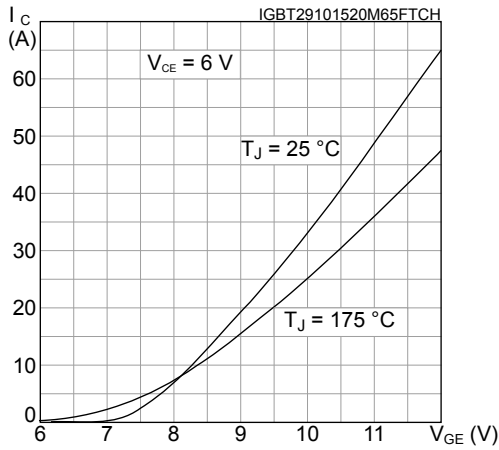
**Figure 7. Collector current vs switching frequency**



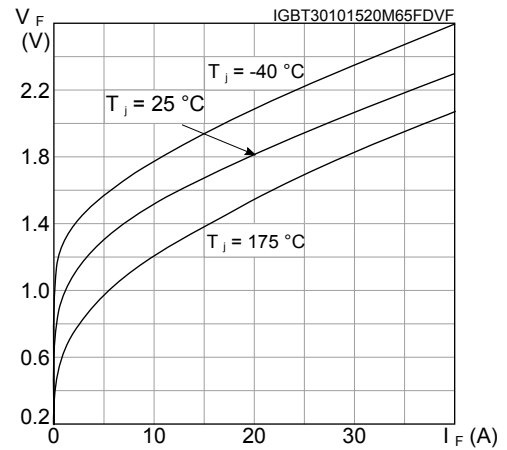
**Figure 8. Forward bias safe operating area**



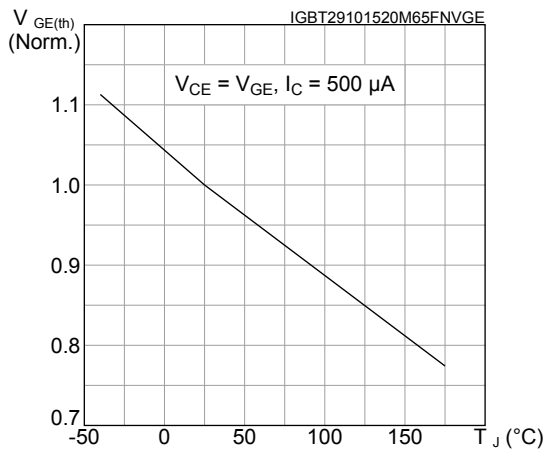
**Figure 9. Transfer characteristics**



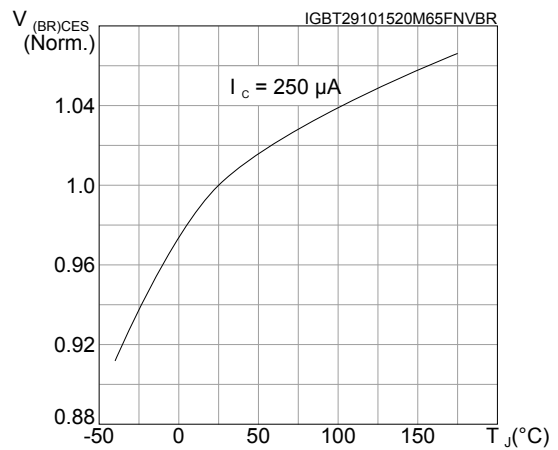
**Figure 10. Diode V\_F vs forward current**



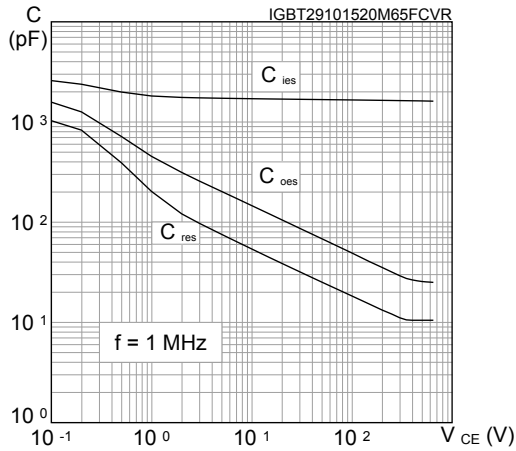
**Figure 11. Normalized V\_GE(th) vs junction temperature**



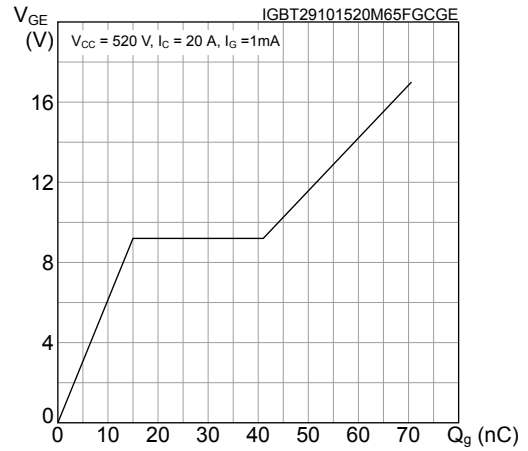
**Figure 12. Normalized V\_(BR)CES vs junction temperature**



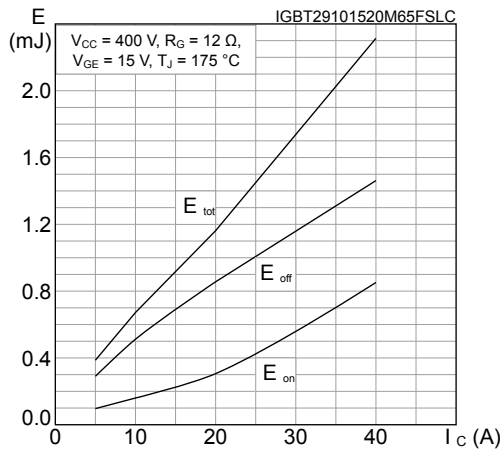
**Figure 13. Capacitance variations**



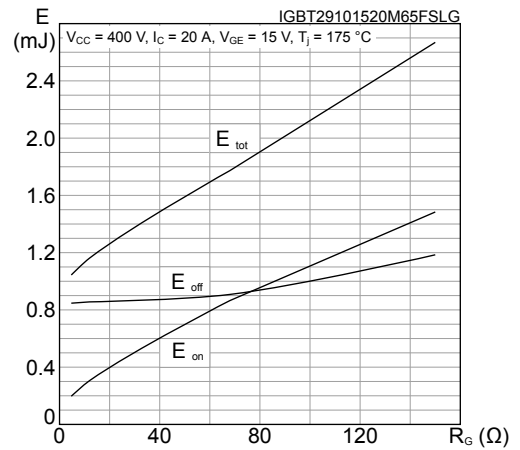
**Figure 14. Gate charge vs gate-emitter voltage**



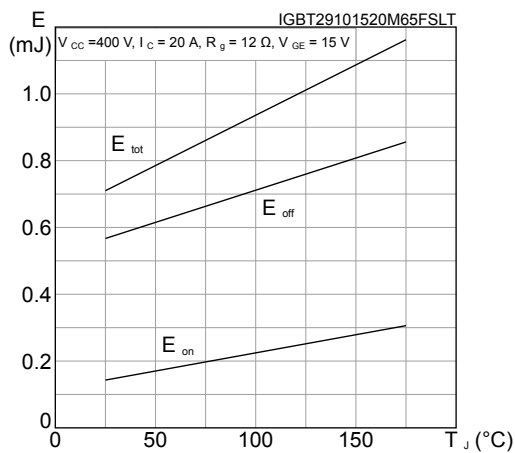
**Figure 15. Switching energy vs collector current**



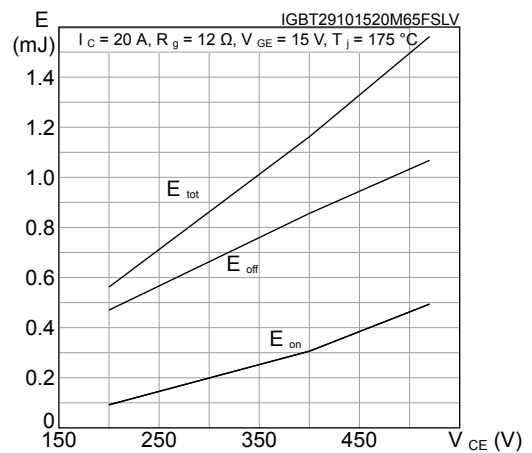
**Figure 16. Switching energy vs gate resistance**



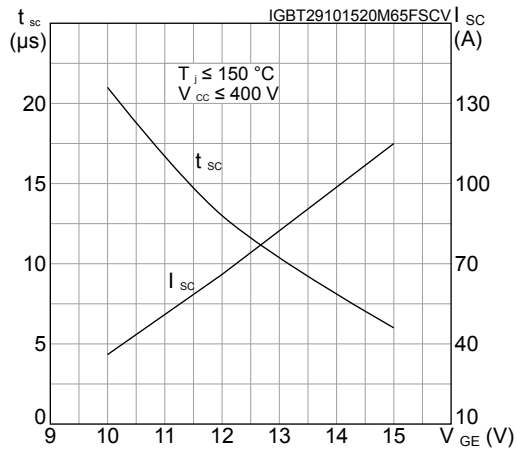
**Figure 17. Switching energy vs temperature**



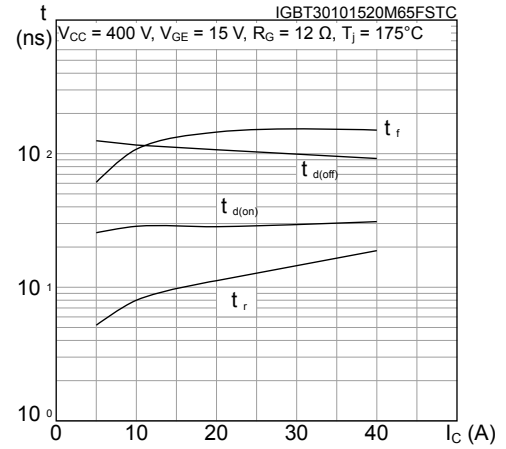
**Figure 18. Switching energy vs collector emitter voltage**



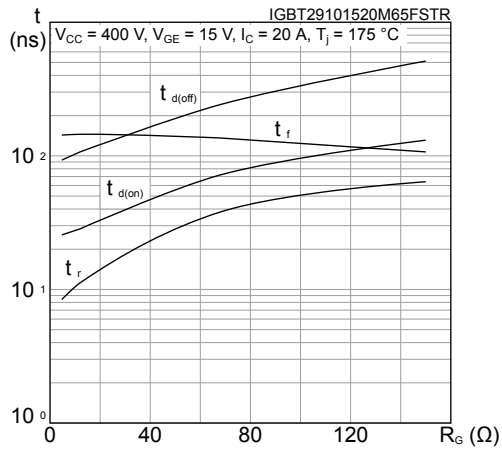
**Figure 19. Short-circuit time and current vs  $V_{GE}$**



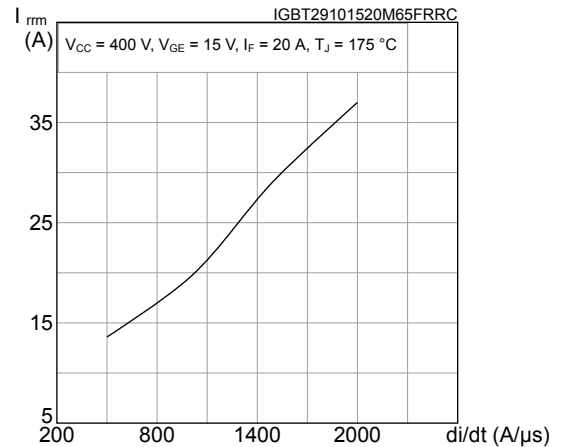
**Figure 20. Switching times vs collector current**



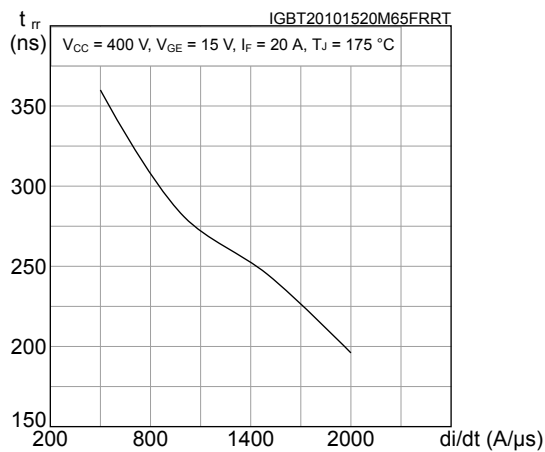
**Figure 21. Switching times vs gate resistance**



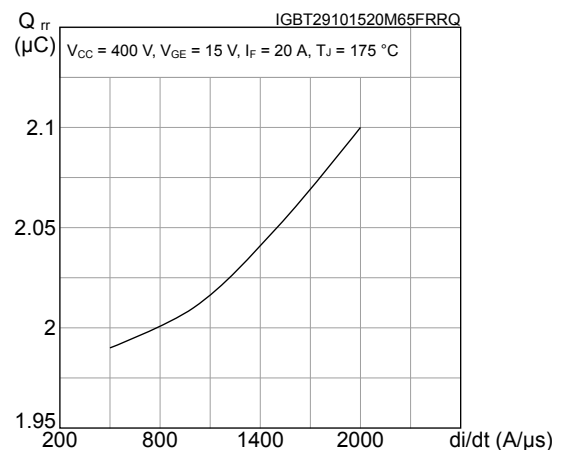
**Figure 22. Reverse recovery current vs diode current slope**



**Figure 23. Reverse recovery time vs diode current slope**

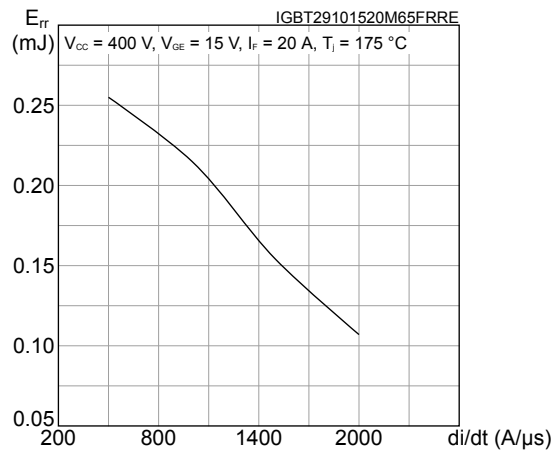


**Figure 24. Reverse recovery charge vs diode current slope**

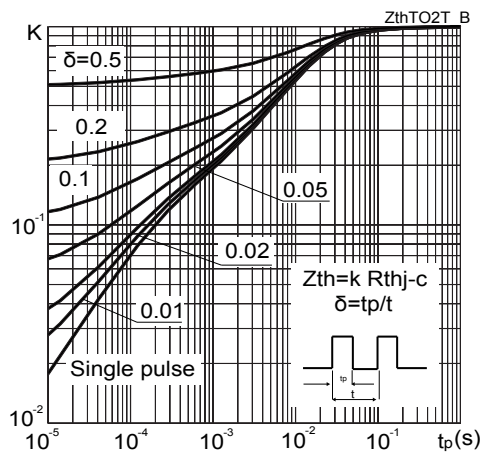




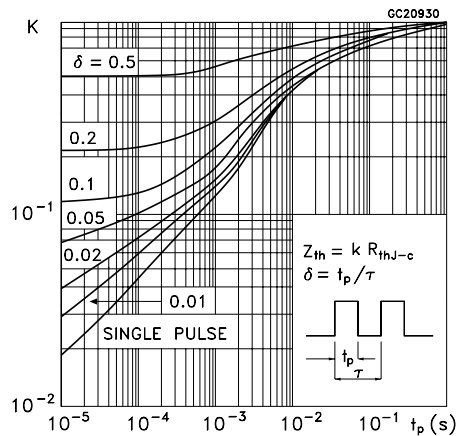
**Figure 25. Reverse recovery energy vs diode current slope**



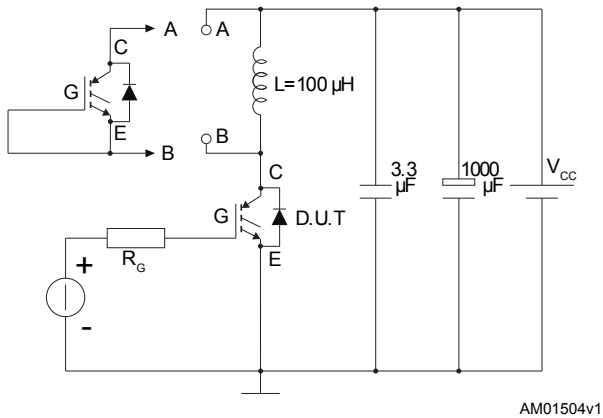
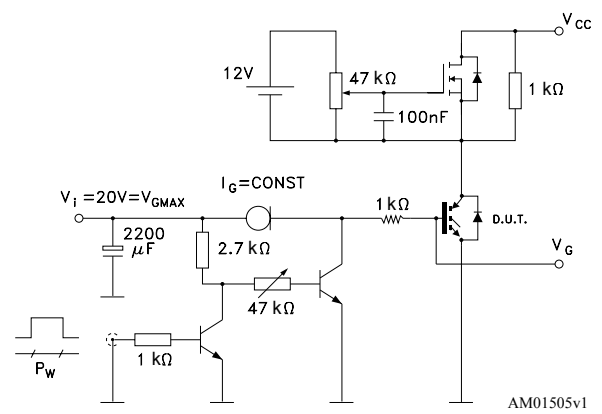
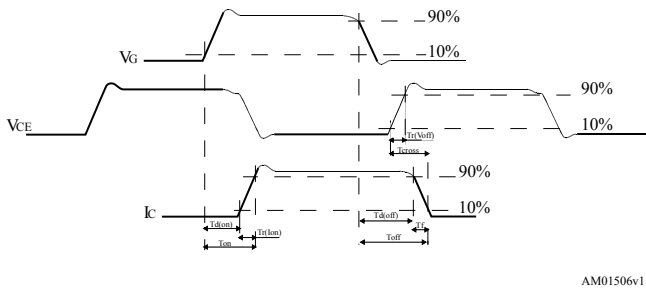
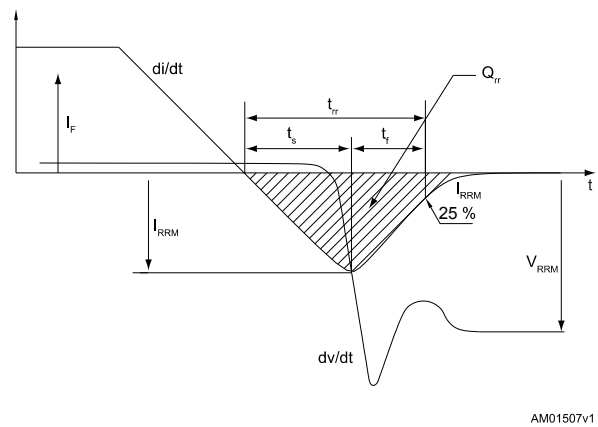
**Figure 26. Thermal impedance for IGBT**



**Figure 27. Thermal impedance for diode**



### 3 Test circuits

**Figure 28. Test circuit for inductive load switching**

**Figure 29. Gate charge test circuit**

**Figure 30. Switching waveform**

**Figure 31. Diode reverse recovery waveform**


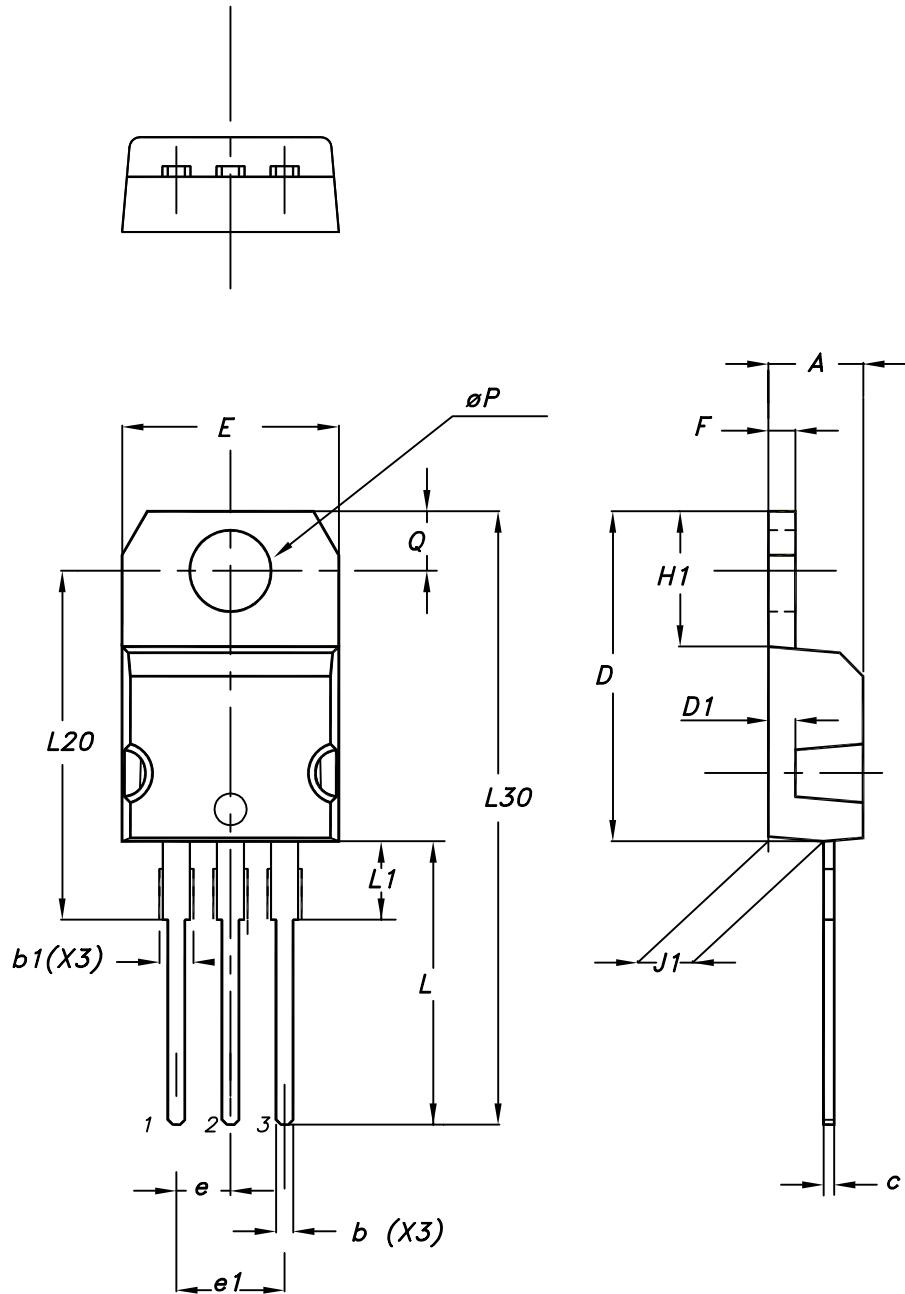
## 4 Package information

---

In order to meet environmental requirements, ST offers these devices in different grades of **ECOPACK<sup>®</sup>** packages, depending on their level of environmental compliance. ECOPACK<sup>®</sup> specifications, grade definitions and product status are available at: [www.st.com](http://www.st.com). ECOPACK<sup>®</sup> is an ST trademark.

## 4.1 TO-220 type A package information

Figure 32. TO-220 type A package outline



0015988\_typeA\_Rev\_21

**Table 7. TO-220 type A package mechanical data**

Dim.	mm		
	Min.	Typ.	Max.
A	4.40		4.60
b	0.61		0.88
b1	1.14		1.55
c	0.48		0.70
D	15.25		15.75
D1		1.27	
E	10.00		10.40
e	2.40		2.70
e1	4.95		5.15
F	1.23		1.32
H1	6.20		6.60
J1	2.40		2.72
L	13.00		14.00
L1	3.50		3.93
L20		16.40	
L30		28.90	
øP	3.75		3.85
Q	2.65		2.95

## Revision history

**Table 8. Document revision history**

Date	Revision	Changes
11-Nov-2015	1	First release.
18-Apr-2016	2	Updated <i>Figure 13: "Normalized <math>V_{(BR)CES}</math> vs. junction temperature "</i> .
08-Oct-2018	3	Updated <a href="#">Table 3. Static characteristics.</a> Minor text changes

## Contents

<b>1</b>	<b>Electrical ratings</b> .....	<b>2</b>
<b>2</b>	<b>Electrical characteristics</b> .....	<b>3</b>
<b>2.1</b>	<b>Electrical characteristics (curves)</b> .....	<b>5</b>
<b>3</b>	<b>Test circuits</b> .....	<b>10</b>
<b>4</b>	<b>Package information</b> .....	<b>11</b>
<b>4.1</b>	<b>D<sup>2</sup>PAK (TO-263) type A package information</b> .....	<b>11</b>
	<b>Revision history</b> .....	<b>14</b>
	<b>Contents</b> .....	<b>15</b>

**IMPORTANT NOTICE – PLEASE READ CAREFULLY**

STMicroelectronics NV and its subsidiaries (“ST”) reserve the right to make changes, corrections, enhancements, modifications, and improvements to ST products and/or to this document at any time without notice. Purchasers should obtain the latest relevant information on ST products before placing orders. ST products are sold pursuant to ST’s terms and conditions of sale in place at the time of order acknowledgement.

Purchasers are solely responsible for the choice, selection, and use of ST products and ST assumes no liability for application assistance or the design of Purchasers’ products.

No license, express or implied, to any intellectual property right is granted by ST herein.

Resale of ST products with provisions different from the information set forth herein shall void any warranty granted by ST for such product.

ST and the ST logo are trademarks of ST. All other product or service names are the property of their respective owners.

Information in this document supersedes and replaces information previously supplied in any prior versions of this document.

© 2018 STMicroelectronics – All rights reserved





Компания «ЭлектроПласт» предлагает заключение долгосрочных отношений при поставках импортных электронных компонентов на взаимовыгодных условиях!

Наши преимущества:

- Оперативные поставки широкого спектра электронных компонентов отечественного и импортного производства напрямую от производителей и с крупнейших мировых складов;
- Поставка более 17-ти миллионов наименований электронных компонентов;
- Поставка сложных, дефицитных, либо снятых с производства позиций;
- Оперативные сроки поставки под заказ (от 5 рабочих дней);
- Экспресс доставка в любую точку России;
- Техническая поддержка проекта, помощь в подборе аналогов, поставка прототипов;
- Система менеджмента качества сертифицирована по Международному стандарту ISO 9001;
- Лицензия ФСБ на осуществление работ с использованием сведений, составляющих государственную тайну;
- Поставка специализированных компонентов (Xilinx, Altera, Analog Devices, Intersil, Interpoint, Microsemi, Aeroflex, Peregrine, Syfer, Eurofarad, Texas Instrument, Miteq, Cobham, E2V, MA-COM, Hittite, Mini-Circuits, General Dynamics и др.);

Помимо этого, одним из направлений компании «ЭлектроПласт» является направление «Источники питания». Мы предлагаем Вам помощь Конструкторского отдела:

- Подбор оптимального решения, техническое обоснование при выборе компонента;
- Подбор аналогов;
- Консультации по применению компонента;
- Поставка образцов и прототипов;
- Техническая поддержка проекта;
- Защита от снятия компонента с производства.



#### Как с нами связаться

**Телефон:** 8 (812) 309 58 32 (многоканальный)

**Факс:** 8 (812) 320-02-42

**Электронная почта:** [org@eplast1.ru](mailto:org@eplast1.ru)

**Адрес:** 198099, г. Санкт-Петербург, ул. Калинина, дом 2, корпус 4, литера А.