

LOC		DIST		REVISIONS			
P	LTN	DESCRIPTION	DATE	DWN	APVD		
L9		REV PER ECR-12-010228	07JUN2012	AY	SZ		
M1		ADD 5-6450130-3	25JUL2012	OL	SZ		

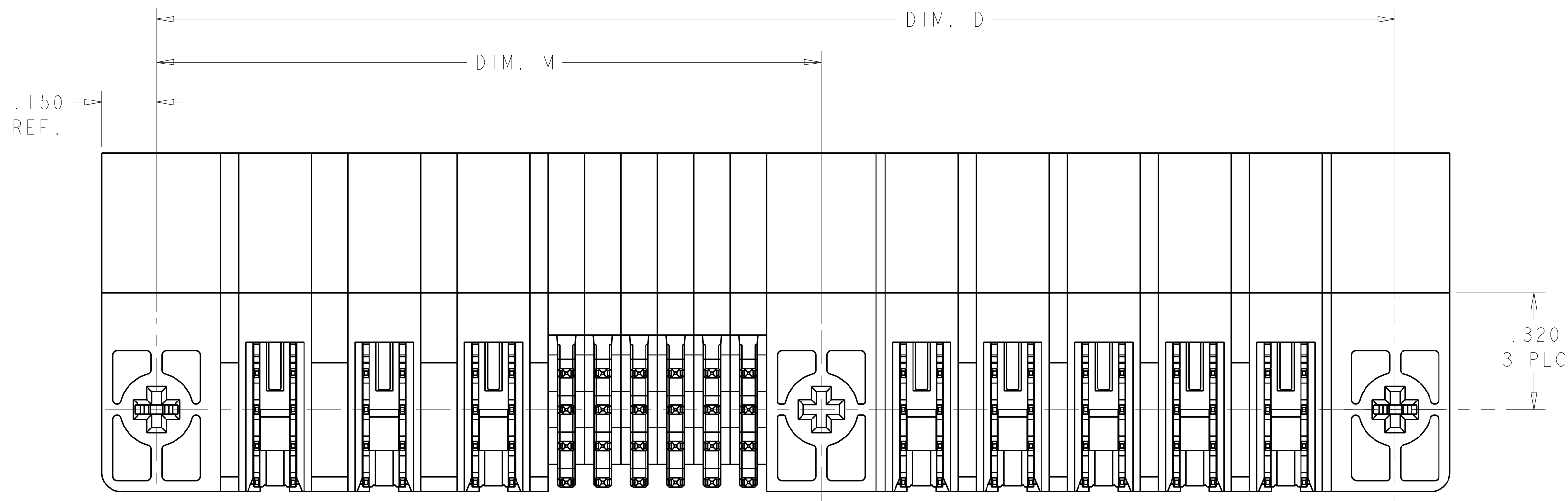
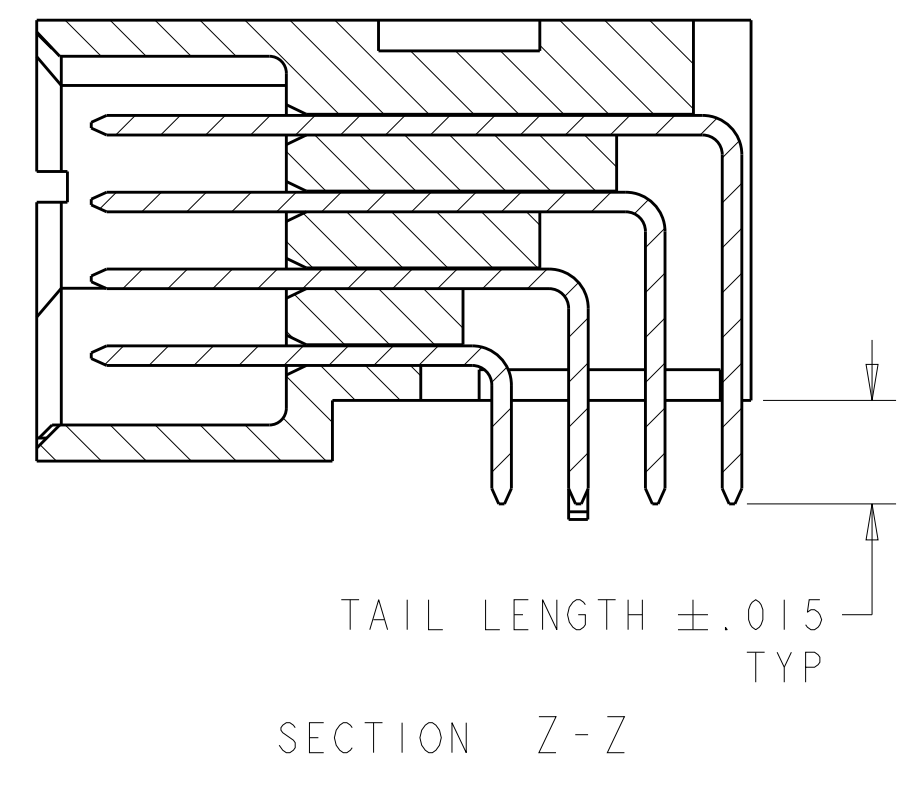
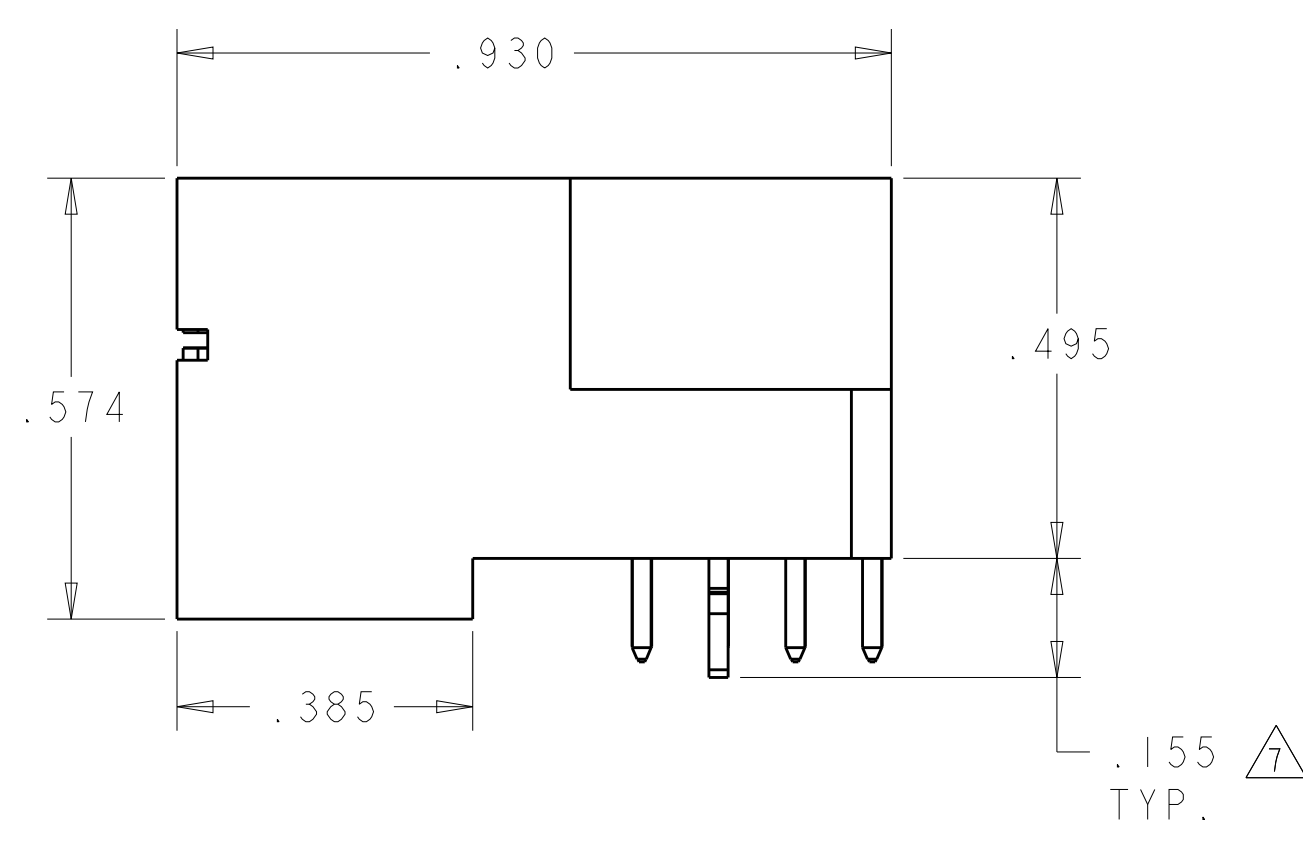
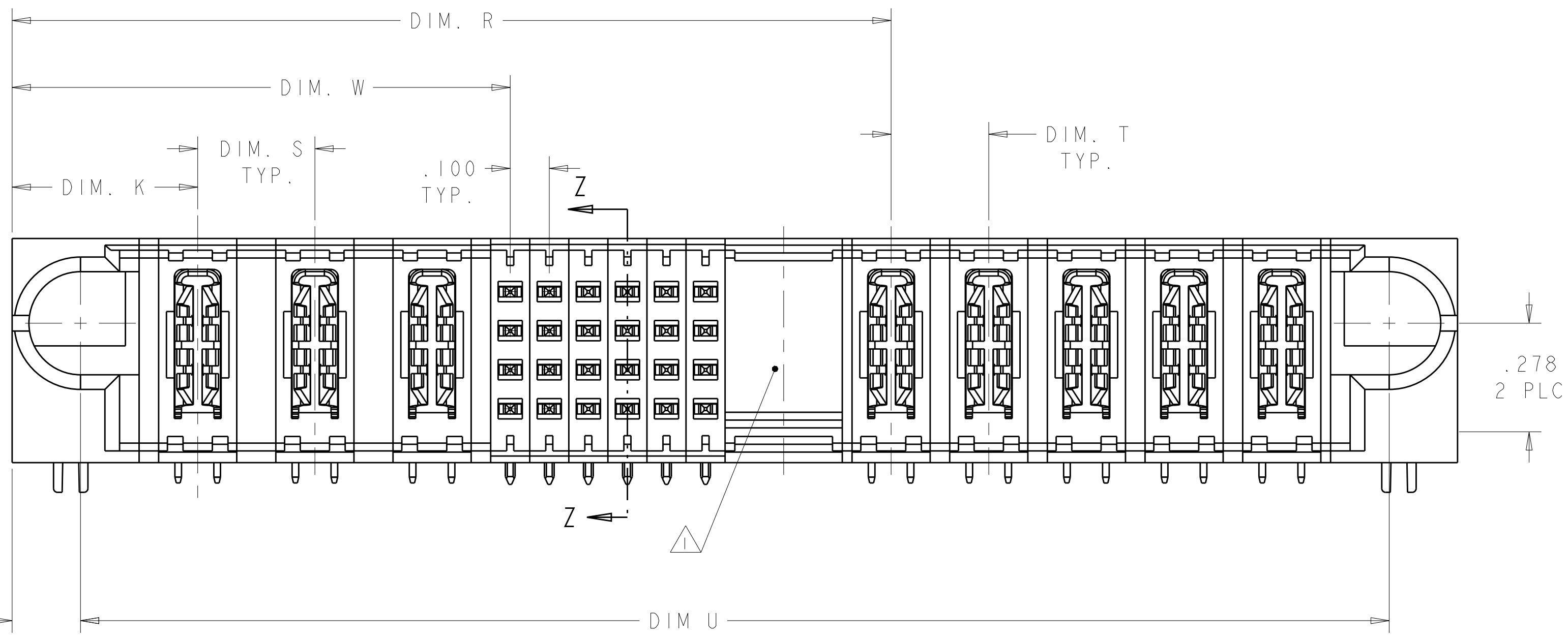
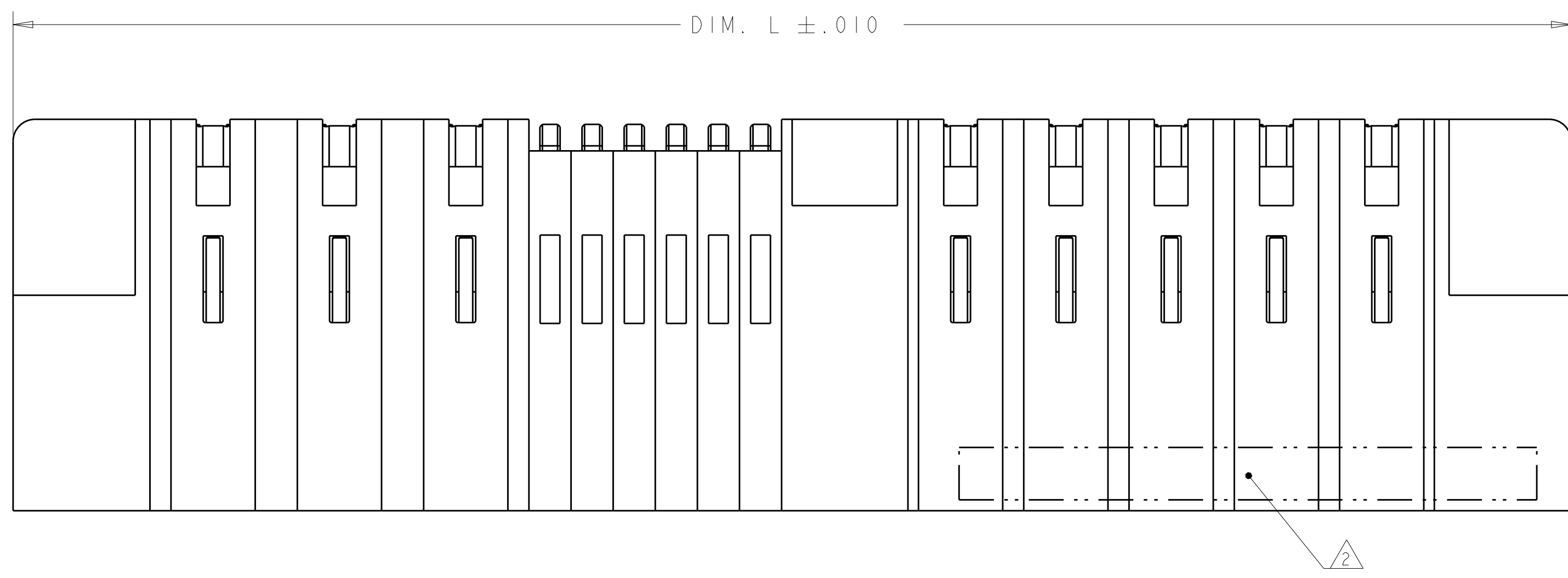

.175 REF

.150 REF

THIS DRAWING IS A CONTROLLED DOCUMENT.

DIMENSIONS: INCHES	TOLERANCES UNLESS OTHERWISE SPECIFIED: 0 PLC $\pm .01$ 1 PLC $\pm .01$ 2 PLC $\pm .01$ 3 PLC $\pm .005$ 4 PLC $\pm .0020$ ANGLES $\pm 30^\circ$	DWN: R.GRZYBOWSKI 4FEB2005 CHK: M.PERCHEK 14FEB2005 APVD: M.PERCHEK 14FEB2005	NAME: RIGHT ANGLE HEADER ASSEMBLY W/GUIDES MULTI-BEAM XL
MATERIAL: 3	FINISH: 4	PRODUCT SPEC: 108-1973 APPLICATION SPEC: 114-13038 WEIGHT: -	SIZE: A1 CAGE CODE: C=6450130 SCALE: 4:1

Customer Drawing SHEET 1 OF 28 REV M2

LOC	DIST	REV	DATE	BY	APPV
ES	00				

- △ OPTIONAL CENTER MODULE WITH Ø.150 THRU HOLE OR HOLD DOWN FEATURE.
- △ "AMP", PART NUMBER, AND DATE CODE TO BE MARKED IN AREA SHOWN.
- △ MATERIAL: HOUSING - GLASS FILLED HIGH TEMP THERMO PLASTIC, UL94 V-0
SIGNAL CONTACT - COPPER ALLOY
POWER CONTACT - HIGH CONDUCTIVITY COPPER ALLOY
- △ CONTACT PLATING: NOBLE METAL PLATING ON CONTACT FUNCTIONAL AREA OF SIGNAL CONTACTS AND POWER CONTACTS.
- △ MECHANICAL CONNECTOR KEEP OUT ZONE.
- △ DATUM AND BASIC DIMENSIONS ESTABLISHED BY CUSTOMER.
- △ HOLD DOWN SEATING DEPTH DIMENSION FOR 6450130-4 IS .185 TYP
- △ PCB - ALL HOLE DIAMETERS ARE FINISHED HOLE SIZES.
- △ PCB - .0453 +/- .0010 DRILLED HOLES PLATES WITH .0003 MIN Sn OVER .001 TO .003 Cu PLATING TO ACHIEVE A .040±.003 DIA HOLE.
- △ VARIABLE DIMS. SHOWN ON VIEW

(L9) PART IS SHEET 27

DIM U	DIM S	DIM T	DIM R	DIM W	DIM D	DIM M	DIM L	DIM K	DESCRIPTION	PART NUMBER
1.600	-	-	1.500	.625	1.650	-	1.950	.450	1P + 32S + 1P	9-6450130-9
2.400	.250	.250	1.550	.875	2.450	-	2.750	.450	2P + 24S + 4P	9-6450130-8
2.400	.250	.250	1.800	1.125	2.450	-	2.750	.450	3P + 24S + 3P	9-6450130-7
1.300	-	-	1.200	.625	1.350	-	1.650	.450	1P + 20S + 1P	9-6450130-6
2.300	.250	.300	1.575	.875	2.350	-	2.650	.450	2P + 24S + 3ACP	9-6450130-5
2.800	.250	.300	2.075	1.375	2.850	-	3.150	.450	4P + 24S + 3ACP	9-6450130-4
1.700	.250	.250	1.350	.875	1.750	-	2.050	.450	2P + 16S + 2P	9-6450130-3

DIM U	DIM S	DIM T	DIM R	DIM W	DIM D	DIM M	DIM L	DIM K	DESCRIPTION	PART NUMBER
2.350	.250	.250	1.250	.875	2.400	-	2.700	.450	2P + 12S + 5P	9-6450130-2
2.400	.250	.250	1.800	1.125	2.450	-	2.750	.450	3P + 24S + 3P	9-6450130-0
1.200	-	-	1.100	.625	1.250	-	1.550	.450	1P + 16S + 1P	8-6450130-9
1.900	.250	.250	1.550	.875	1.950	-	2.250	.450	2P + 24S + 2P	8-6450130-8
2.900	.250	.250	2.550	.875	2.950	-	3.250	.450	2P + 64S + 2P	8-6450130-7
2.400	.250	.250	1.800	1.125	2.450	-	2.750	.450	3P + 24S + 3P	8-6450130-6
1.300	-	-	1.200	.675	1.350	-	1.650	.450	1P + 16S + 1P	8-6450130-5
2.800	.250	.250	1.700	1.125	2.850	-	3.150	.450	3P + 20S + 5P	8-6450130-4
2.800	.250	.300	2.075	1.375	2.850	-	3.150	.450	4P + 24S + 3ACP	8-6450130-2
2.850	.250	.250	2.500	1.875	2.900	-	3.200	.450	6P + 20S + 2P	8-6450130-0
2.600	.250	.250	2.250	1.625	2.650	-	2.950	.450	5P + 20S + 2P	7-6450130-9
2.400	.250	.250	1.800	1.125	2.450	-	2.750	.450	3P + 24S + 3P	7-6450130-8
4.800	.250	.250	3.450	1.875	4.850	-	5.150	.450	6P + 60S + 6P	7-6450130-7
3.050	.300	.250	1.950	1.275	3.100	-	3.400	.475	3ACP + 24S + 5P	7-6450130-6
2.400	.250	.250	1.800	1.125	2.450	-	2.750	.450	3P + 24S + 3P	7-6450130-5
6.250	.250	△	5.050	4.375	6.300	-	6.600	.450	16P + 24S + 2P + 3ACP	7-6450130-4
2.000	.300	.250	1.650	1.325	2.050	-	2.350	.475	3ACP + 8S + 2P	7-6450130-1
2.500	.250	.250	2.150	.875	2.550	-	2.850	.450	2P + 48S + 2P	6-6450130-9
1.900	.250	.250	1.550	.875	1.950	-	2.250	.450	2P + 24S + 2P	6-6450130-7
2.500	.250	.250	2.150	1.425	2.550	-	2.850	.450	4P + 24S + 2P	5-6450130-8
6.300	△	△	3.925	3.275	6.350	-	6.650	.425	14P + 24S + 12P	5-6450130-6
3.100	.200	.200	2.225	1.375	3.150	-	3.450	.425	5P + 32S + 5P	5-6450130-5
2.400	.200	.200	1.900	1.225	2.450	-	2.750	.450	4HDP + 24S + 3HDP	5-6450130-3
2.300	.300	.250	1.950	1.275	2.350	-	2.650	.450	3ACP + 24S + 2P	5-6450130-1
4.000	.300	.300	2.675	1.925	4.050	-	4.350	.475	5ACP + 24S + 5ACP	5-6450130-0
3.000	.250	.250	2.150	1.425	3.050	-	3.350	.450	4P + 24S + 4P	4-6450130-9
3.300	.250	.250	2.450	1.375	3.350	-	3.650	.450	4P + 40S + 4P	4-6450130-8
3.100	.200	.200	2.225	1.375	3.150	-	3.450	.425	5P + 32S + 5P	4-6450130-5
2.100	.300	.250	1.750	1.275	2.150	-	2.450	.475	3ACP + 16S + 2P	4-6450130-3
1.900	.250	.250	1.550	.875	1.950	-	2.250	.450	2P + 24S + 2P	4-6450130-2
2.100	.200	.200	1.425	1.175	2.150	-	2.450	.425	4P + 8S + 4P	4-6450130-0
2.100	.300	.250	1.750	1.275	2.150	-	2.450	.475	3ACP + 16S + 2P	3-6450130-9
4.675	.250	.300	3.950	3.375	4.725	-	5.025	.450	12P + 20S + 3ACP	3-6450130-6
3.500	.250	.250	2.900	1.625	3.550	-	3.850	.450	5P + 48S + 3P	3-6450130-2
1.900	.250	.250	1.550	.875	1.950	-	2.250	.450	2P + 24S + 2P	2-6450130-9
3.250	.250	.250	2.900	1.125	3.300	-	3.600	.450	3P + 68S + 2P	2-6450130-8
2.300	.300	.250	1.950	1.275	2.350	-	2.650	.475	3ACP + 24S + 2P	2-6450130-6
2.600	.200	.200	1.925	1.175	2.650	-	2.950	.425	4HDP + 28S + 4HDP	2-6450130-4
3.200	.200	.200	2.125	1.575	3.250	-	3.550	.425	6P + 20S + 6P	2-6450130-3
2.800	.250	.300	2.075	1.375	2.850	-	3.150	.450	4P + 24S + 3ACP	2-6450130-2
3.500	.200	.200	2.225	1.775	3.550	-	3.850	.425	7P + 16S + 7P	2-6450130-1
5.450	△	△	3.075	2.425	5.500	-	5.800	.425	10P + 24S + 12P	2-6450130-0
4.400	.250	.250	4.050	.875	4.450	-	4.750	.450	2P + 124S + 2P	1-6450130-9
4.275	△	.250	3.175	2.500	4.325	-	4.625	.475	2ACP + 6P + 24S + 5P	1-6450130-8
1.900	.250	.250	1.550	.875	1.950	-	2.250	.450	2P + 24S + 2P	1-6450130-7
3.300	.300	.250	1.950	1.275	3.350	-	3.650	.475	3ACP + 24S + 6P	1-6450130-4
4.050	.250	-	3.950	.875	4.100	-	4.400	.450	2P + 120S + 1P	1-6450130-3
3.250	.250	-	3.150	.875	3.300	-	3.600	.450	2P + 88S + 1P	1-6450130-2
1.400	-	-	1.300	.625	1.450	-	1.750	.450	1P + 24S + 1P	1-6450130-1
2.900	.250	.250	2.550	.875	2.950	-	3.250	.450	2P + 64S + 2P	1-6450130-0
2.550	.250	.300	1.825	1.125	2.600	-	2.900	.450	3P + 24S + 3ACP	6450130-9
2.675	.200	.200	2.375	1.650	2.725	-	3.025	.450	5P + 24S + 2P	6450130-8
3.650	.250	.250	2.550	1.875	3.700	-	4.000	.450	6P + 24S + 5P	6450130-7
2.400	.250	.250	1.800	1.125	2.450	-	2.750	.450	3P + 24S + 3P	6450130-6
4.350	.250	.250	3.500	2.625	4.400	-	4.700	.450	9P + 32S + 4P	6450130-5
2.800	.250	.300	2.075	1.375	2.850	-	3.150	.450	4P + 24S + 3ACP	6450130-4
3.050	.300	.250	1.950	1.275	3.100	-	3.400	.475	3ACP + 24S + 5P	6450130-3
2.550	.300	.250	2.200	1.525	2.600	-	2.900	.475	3ACP + 1P + 24S + 2P	6450130-2
3.650	.300	.250	2.550	1.275	3.700	-	4.000	.475	3ACP + 48S + 5P	6450130-1

THIS DRAWING IS A CONTROLLED DOCUMENT.

OWNER: R. GRZYBOWSKI 4FEB2005
 CHK: M. PERCHERKE 14FEB2005
 APVD: M. PERCHERKE 14FEB2005

DIMENSIONS: INCHES
 TOLERANCES UNLESS OTHERWISE SPECIFIED:
 0 PLC ±.01
 1 PLC ±.01
 2 PLC ±.01
 3 PLC ±.005
 4 PLC ±.002
 ANGLES ±.002

MATERIAL: FINISH:

DATE: 108-1973
 APPLICATION SPEC: 114-13038

WEIGHT: Customer Drawing

SCALE: 4:1

SHEET 2 OF 28

REV M2

STE TE Connectivity

RIGHT ANGLE HEADER ASSEMBLY W/GUIDES MULTI-BEAM XL

SIZE: A1 00779 C=6450130

PART NUMBER	ROWS	POWER			SIGNAL								POWER											
		P1	P2	P3	1	2	3	4	5	6	7	8	9	10	11	12	P4	P5	P6	P7	P8			
6450130-1	D C B A	PM	PM	PM	J	J	J	J	J	J	J	J	J	J	J	J	PM	PM	PM	PM	PM	PM	PM	
					K	K	K	K	K	K	K	K	K	K	K	K								
					N	N	N	N	N	N	N	N	N	N	N	N								N
					S	S	S	S	S	S	S	S	S	S	S	S								H
3ACP + 48S + 5P																								

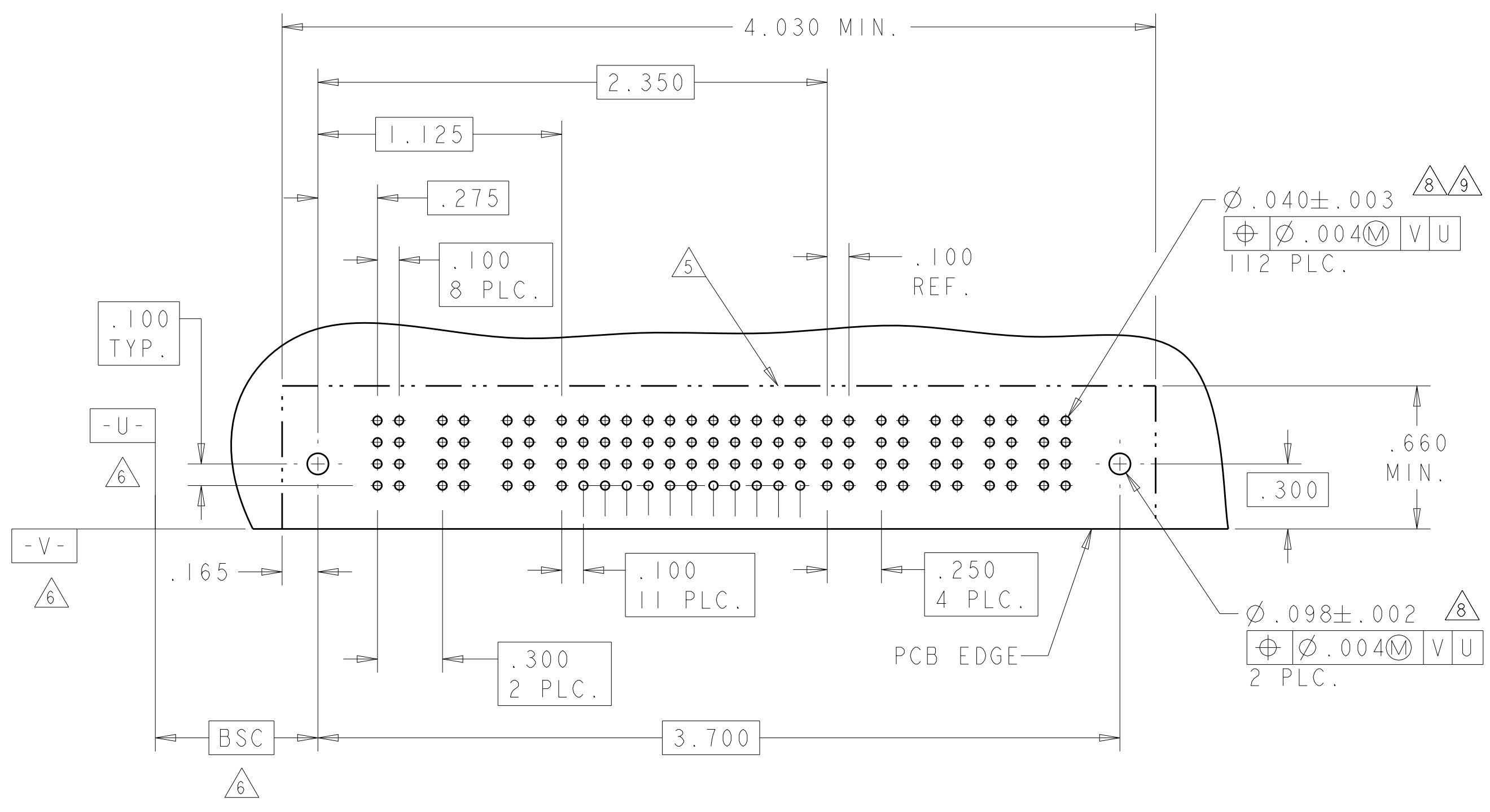

NO CONTACT LOADED

PART NUMBER	ROWS	POWER				SIGNAL						POWER			
		P1	P2	P3	P4	1	2	3	4	5	6	P5	P6		
6450130-2	D C B A	PM	PM	PM	PM	E	J	J	J	J	E	PM	PM	PM	PM
						K	K	F	K	K	K				
						N	N	N	N	N	N				
						H	S	S	S	S	H				
3ACP + 1P + 24S + 2P															

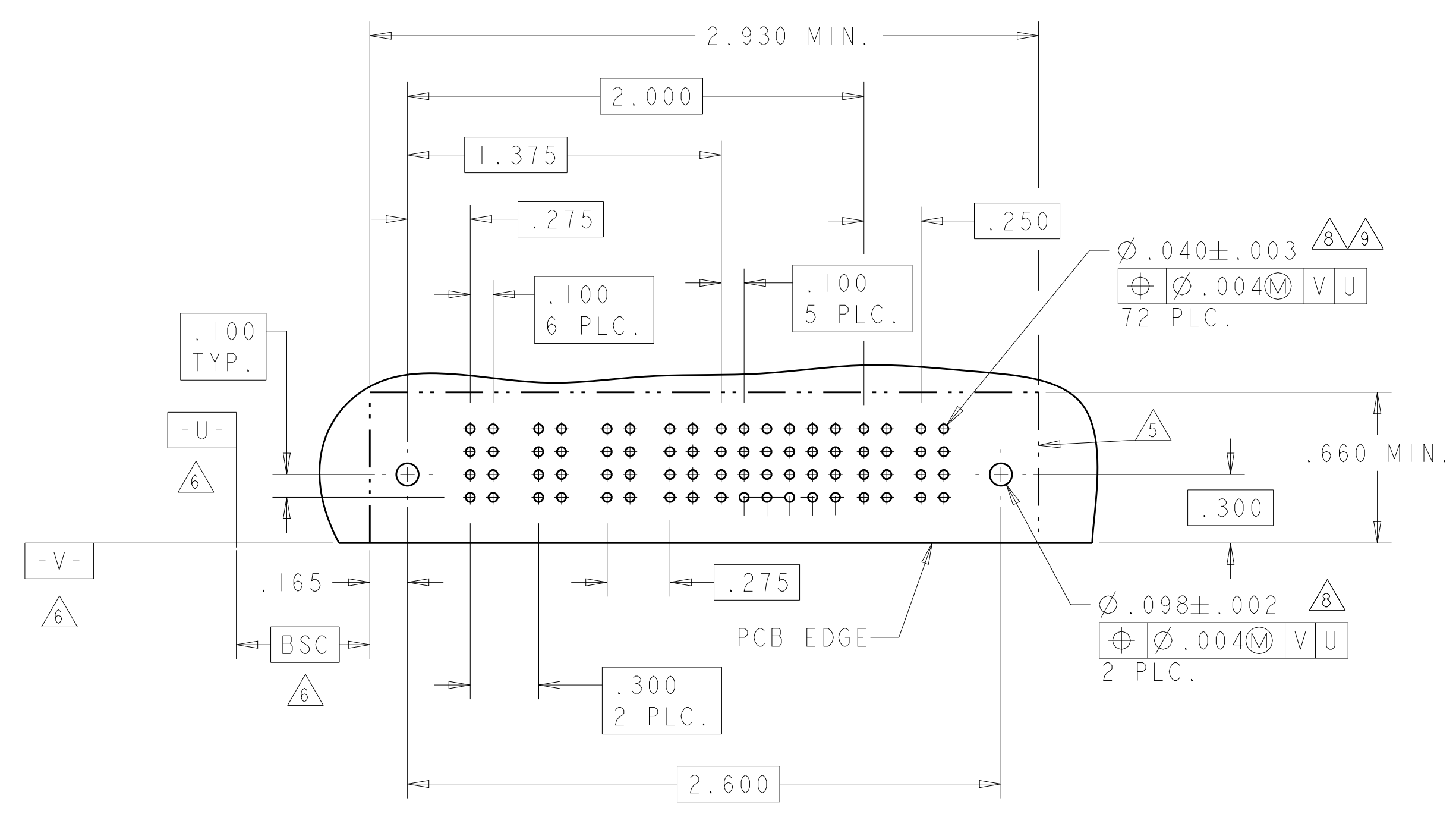

LOC	DIST	REV	DATE	BY	APPV
ES	00				

PART NUMBER	ROWS	POWER			SIGNAL						POWER					
		P1	P2	P3	1	2	3	4	5	6	P4	P5	P6	P7	P8	
6450130-3	D C B A	PM	PM	PM	J	J	J	J	E	J	PM	PM	PM	PM	PM	PM
					K	K	F	K	K	K						
					N	N	N	N	N	G						
					S	S	H	S	S	S						
3ACP + 24S + 5P																

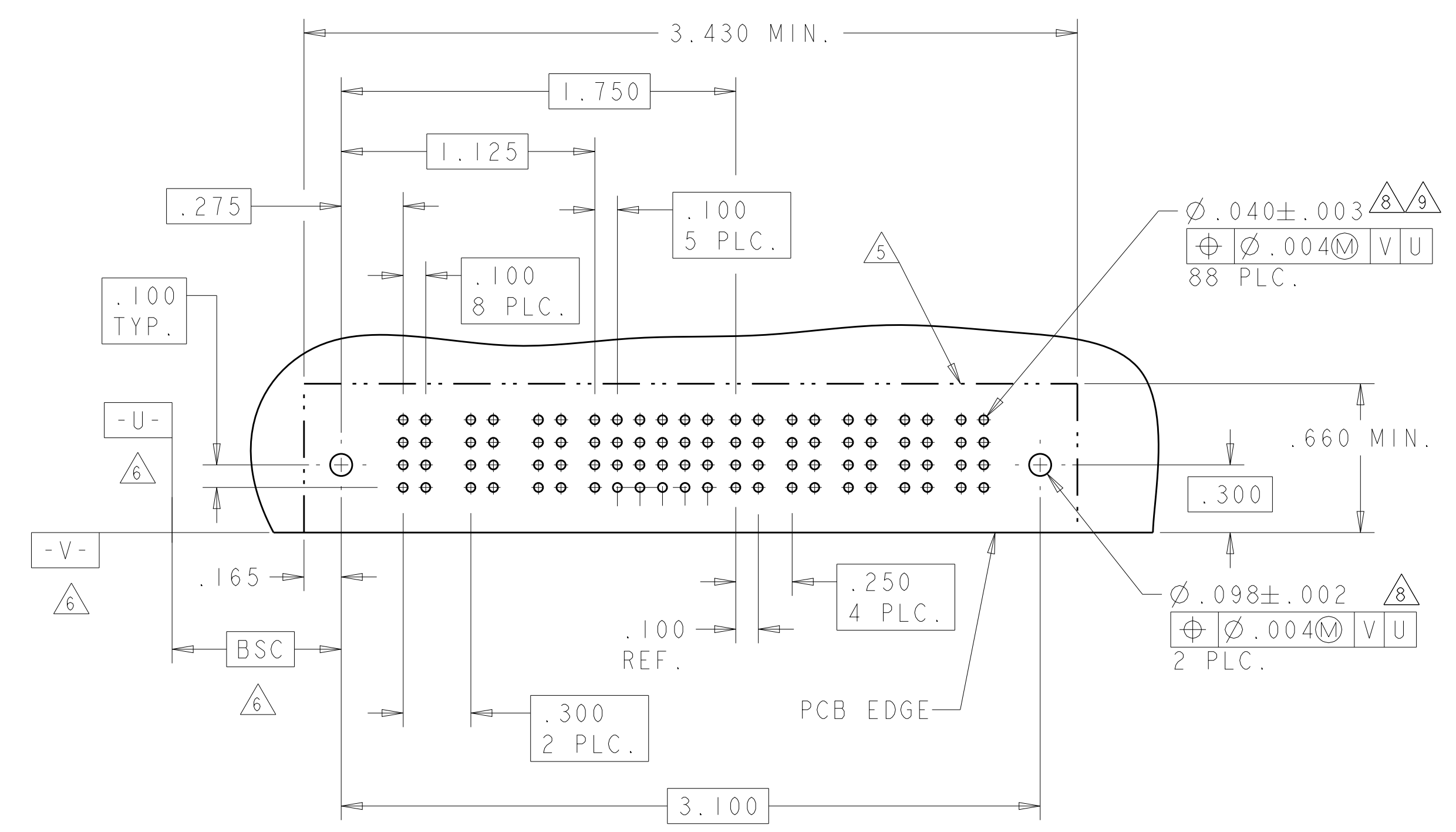

CODE	TAIL LENGTH	DESCRIPTION
PM	.135	MULTI-BEAM
PA	.090	MULTI-BEAM
POWER CONTACT		

CODE	MATING SEQUENCE	TAIL LENGTH	ROW
Z	STD	.090	D
Y	STD	.090	C
R	STD	.090	B
O	STD	.090	A
A4	MLBF	.090	D
A3	MLBF	.090	C
A2	MLBF	.090	B
A1	MLBF	.090	A
E	MLBF	.135	D
F	MLBF	.135	C
G	MLBF	.135	B
H	MLBF	.135	A
J	STD	.135	D
K	STD	.135	C
N	STD	.135	B
S	STD	.135	A
SIGNAL CONTACT			

THIS DRAWING IS A CONTROLLED DOCUMENT.

OWN: R. GRZYBOWSKI 14FEB2005
 CHK: M. PERCHERKE 14FEB2005
 APVD: M. PERCHERKE 14FEB2005

STE TE Connectivity

RIGHT ANGLE HEADER ASSEMBLY W/GUIDES MULTI-BEAM XL

SIZE: CAGE CODE: DRAWING NO: A100779C=6450130
 SCALE: 4:1 SHEET 3 OF 28 REV: M2

PART NUMBER	ROWS	POWER				SIGNAL						POWER			
		P1	P2	P3	P4	1	2	3	4	5	6	P5	P6	P7	
6450130-4	D C B A	PM	PM	PM	PM	J	J	J	J	J	J	PM	PM	PM	HD
						K	K	K	K	K	K				
						N	N	N	N	N	N				
						S	S	S	S	S	H				
4P + 24S + 3ACP															

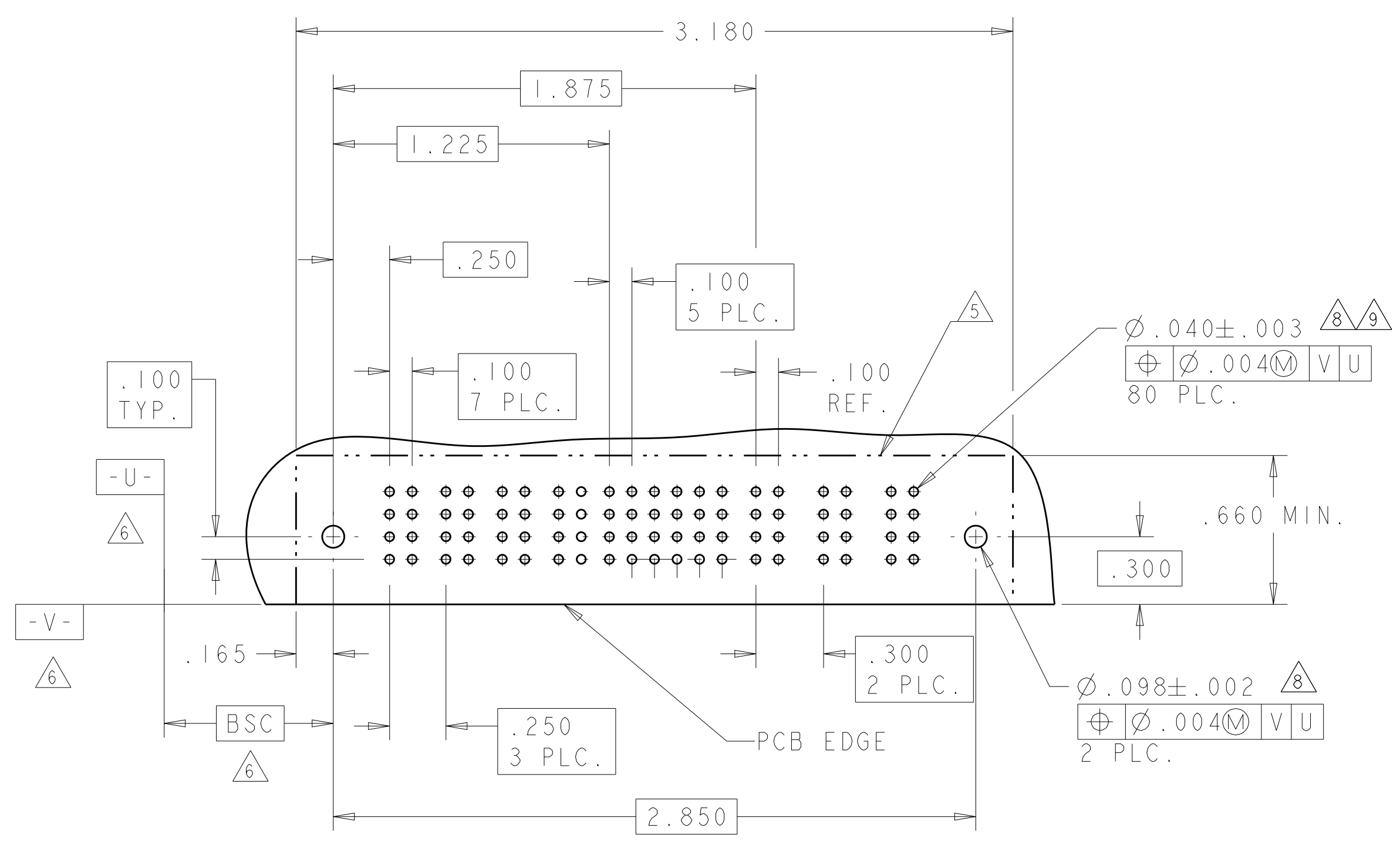

LOC	DIST	REV	DATE	BY	APPV
ES	00				
DESCRIPTION			DATE	BY	APPV
SEE SHEET 1					

PART NUMBER	ROWS	POWER			SIGNAL						POWER			
		P1	P2	P3	1	2	3	4	5	6	P4	P5	P6	
6450130-6	D C B A	PM	PM	PM	J	J	J	J	J	J	PM	PM	PM	HD
					K	K	K	K	K	K				
					N	N	G	N	N	N				
					S	S	S	S	S	S				
3P + 24S + 3P														

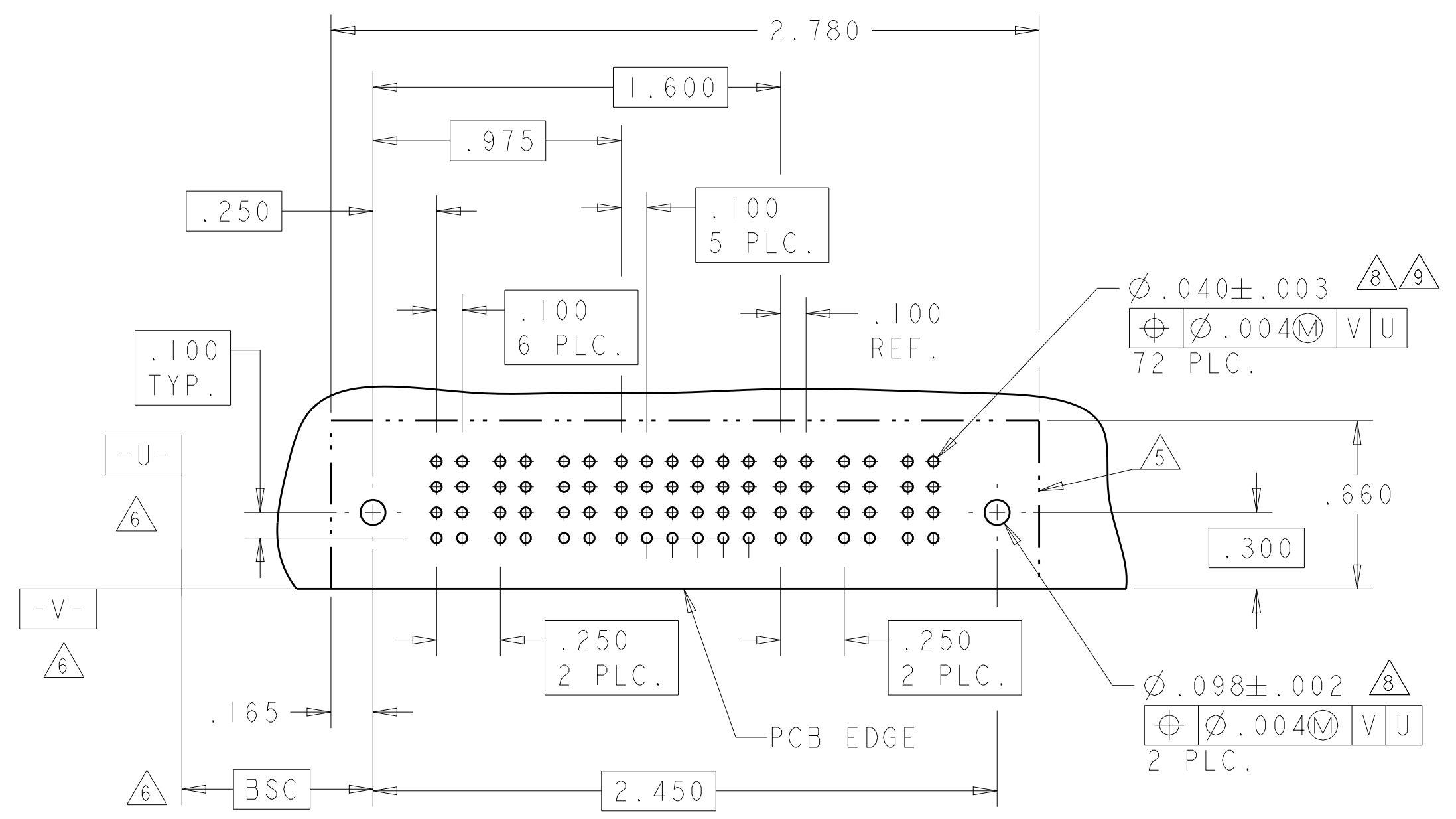

NO CONTACT LOADED

PART NUMBER	ROWS	POWER									SIGNAL								POWER									
		P1	P2	P3	P4	P5	P6	P7	P8	P9	1	2	3	4	5	6	7	8	P10	P11	P12	P13						
6450130-5	D C B A	PM	PM	PM	PM	PM	PM	PM	PM	PM	J	J	J	J	J	J	J	J	PM	PM	PM	PM	HD					
											K	K	K	K	K	K	K	K						E	E	E	E	
											N	N	N	N	N	N	N	N						N	N	N	N	N
											S	S	S	S	S	S	S	S						S	S	S	S	S
9P + 32S + 4P																												

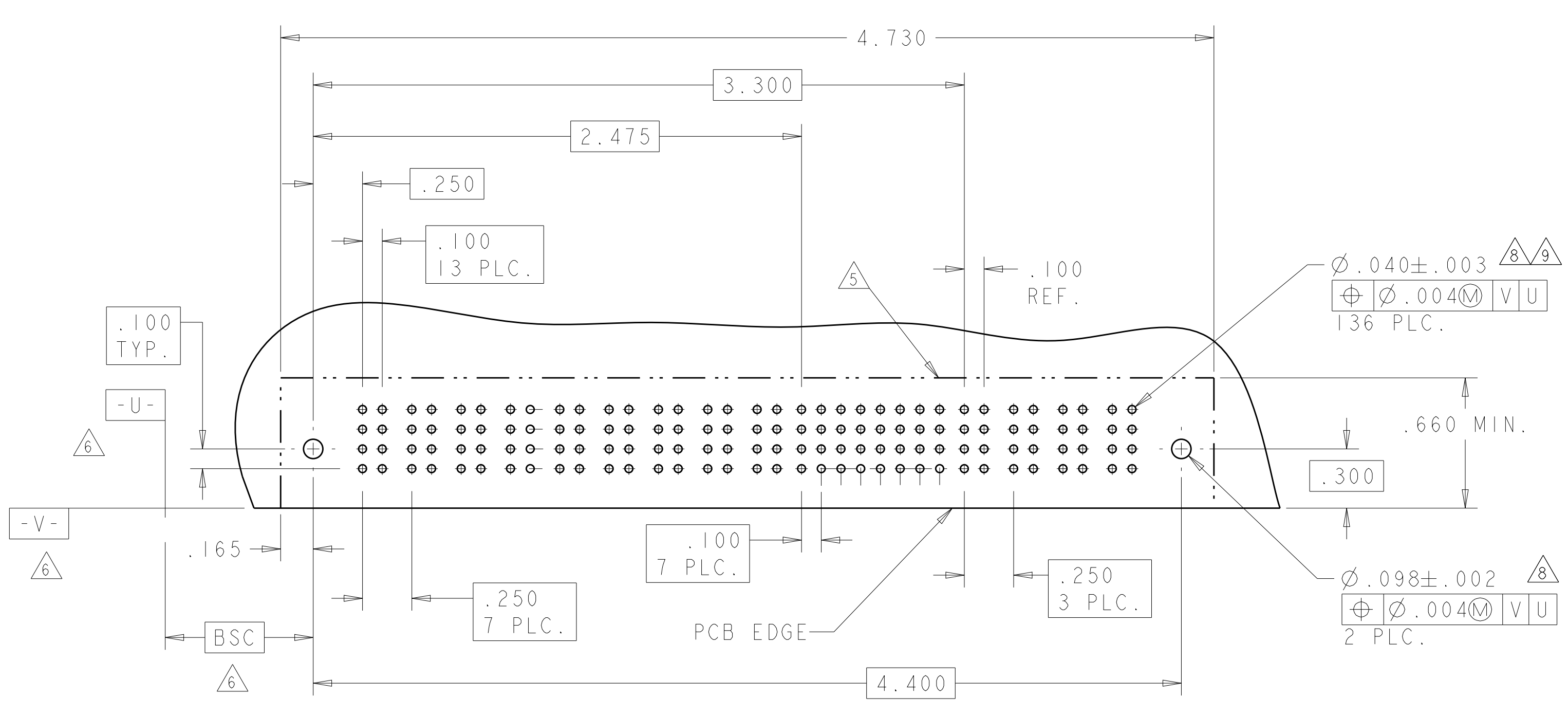

PART NUMBER	ROWS	POWER						SIGNAL						POWER					
		P1	P2	P3	P4	P5	P6	1	2	3	4	5	6	P7	P8	P9	P10	P11	
6450130-7	D C B A	PM	PM	PM	PM	PM	PM	J	J	J	J	J	J	PM	PM	PM	PM	PM	HD
								K	K	F	K	K	K						
								N	N	N	N	N	G						
								S	S	H	S	S	S						
6P + 24S + 5P																			

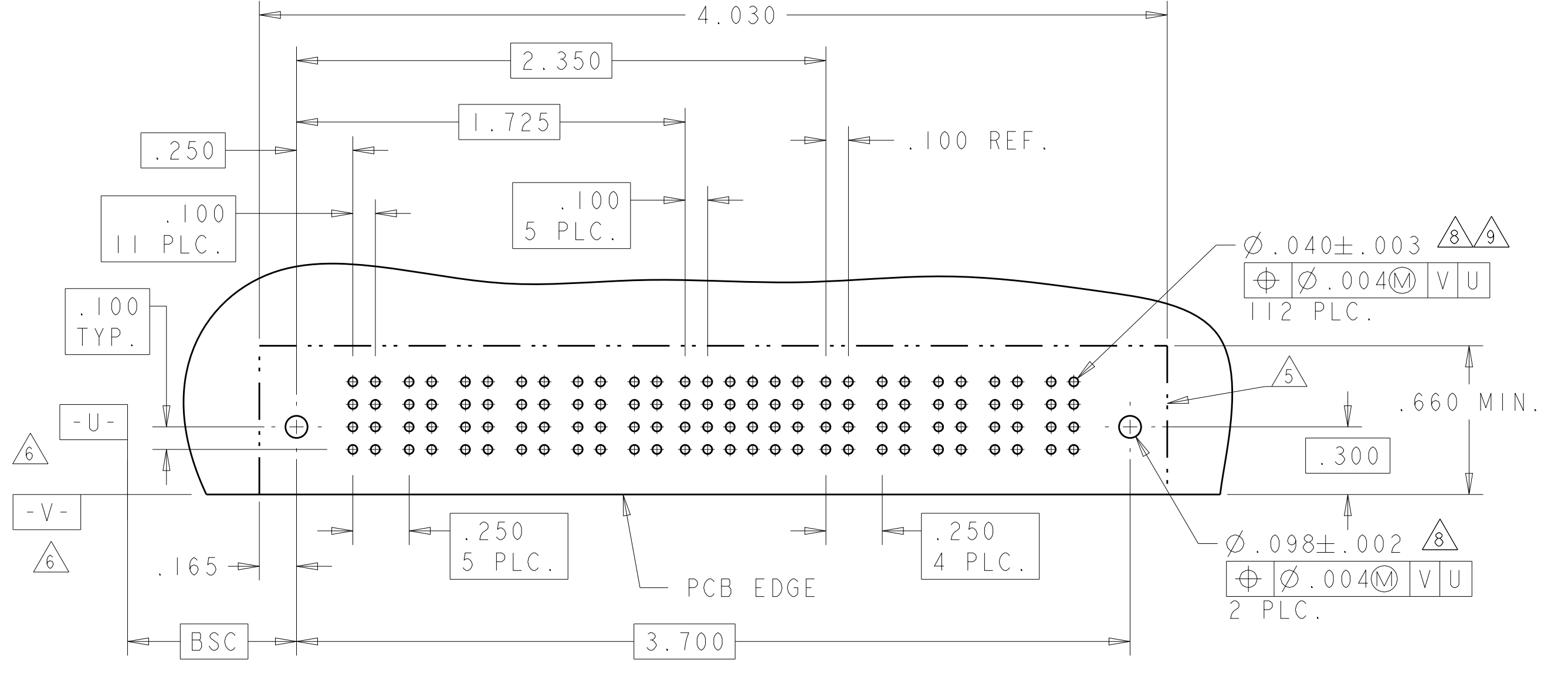

THIS DRAWING IS A CONTROLLED DOCUMENT.

DIMENSIONS: INCHES 	TOLERANCES UNLESS OTHERWISE SPECIFIED: 0 PLC ±. 1 PLC ±.01 2 PLC ±.01 3 PLC ±.005 4 PLC ±.002 ANGLES ±.0020	DWN: R. GRZYBOWSKI 14FEB2005 CHK: M. PERCHERKE 14FEB2005 APVD: M. PERCHERKE 14FEB2005 PRODUCT SPEC 108-1973 APPLICATION SPEC 114-13038 WEIGHT Customer Drawing	TE Connectivity RIGHT ANGLE HEADER ASSEMBLY W/GUIDES MULTI-BEAM XL SIZE: A1 CAGE CODE: 00779 DRAWING NO: 6450130 SHEET 4 OF 28 REV M2 SCALE 4:1
---------------------------	---	--	---

PART NUMBER	ROWS	POWER					SIGNAL						POWER	
		P1	P2	P3	P4	P5	1	2	3	4	5	6	P6	P7
6450130-8	D C B A	PM	PM	PM	PM		J	J	J	J	J	J	PM	PM
							K	K	K	K	K	K		
							N	N	N	N	N	G		
							S	S	S	S	S	S		

5P + 24S + 2P

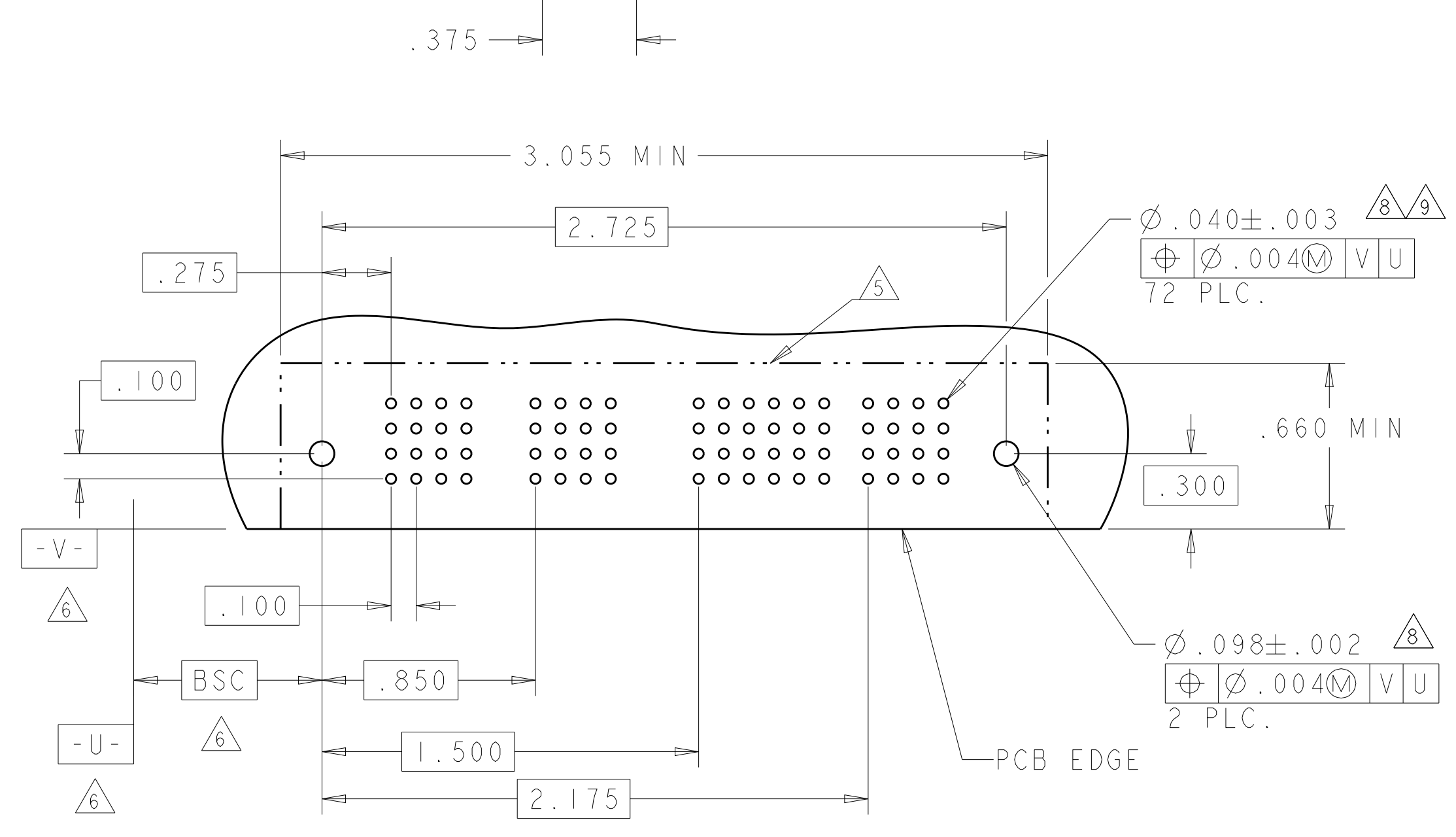

PART NUMBER	ROWS	POWER		SIGNAL												POWER					
		P1	P2	1	2	3	4	5	6	7	8	9	10	11	12	13	14	15	16	P3	P4
1-6450130-0	D C B A	PA	PA	A4	A4	A4	A4	A4	A4	A4	A4	A4	A4	A4	A4	A4	A4	A4	A4	PA	PA
				A3	A3	A3	A3	A3	A3	A3	A3	A3	A3	A3	A3	A3	A3	A3	A3		
				A2	A2	A2	A2	A2	A2	A2	A2	A2	A2	A2	A2	A2	A2	A2	A2		
				A1	A1	A1	A1	A1	A1	A1	A1	A1	A1	A1	A1	A1	A1	A1	O		

2P + 64S + 2P

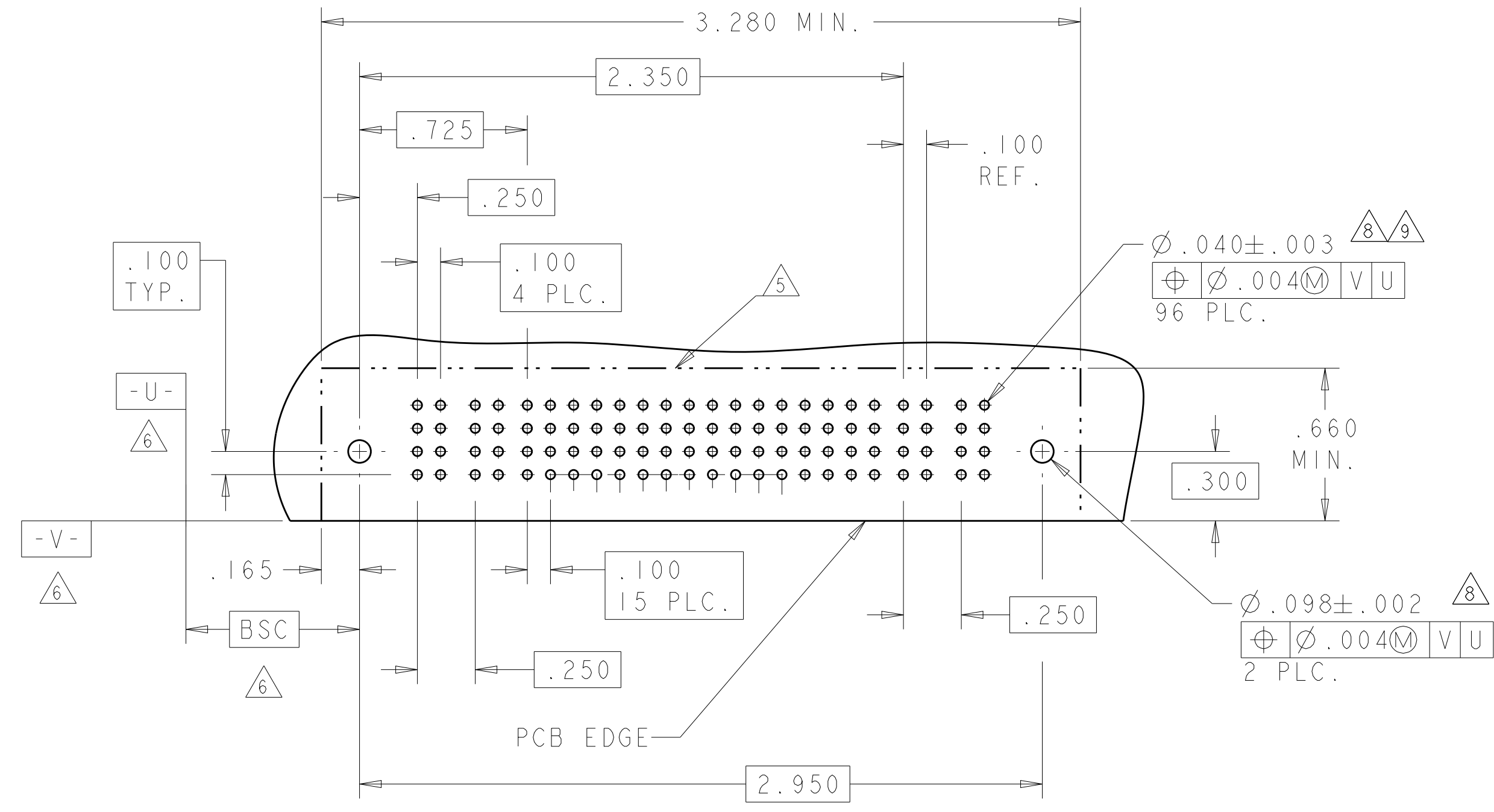

PART NUMBER	ROWS	POWER			SIGNAL						POWER		
		P1	P2	P3	1	2	3	4	5	6	P4	P5	P6
6450130-9	D C B A	PA	PA	PA	Z	A	A	A	A	A	PA	PA	PA
					Y	A	A	A	A	A			
					R	A	A	A	A	A			
					O	A	A	A	A	O			

3P + 24S + 3ACP

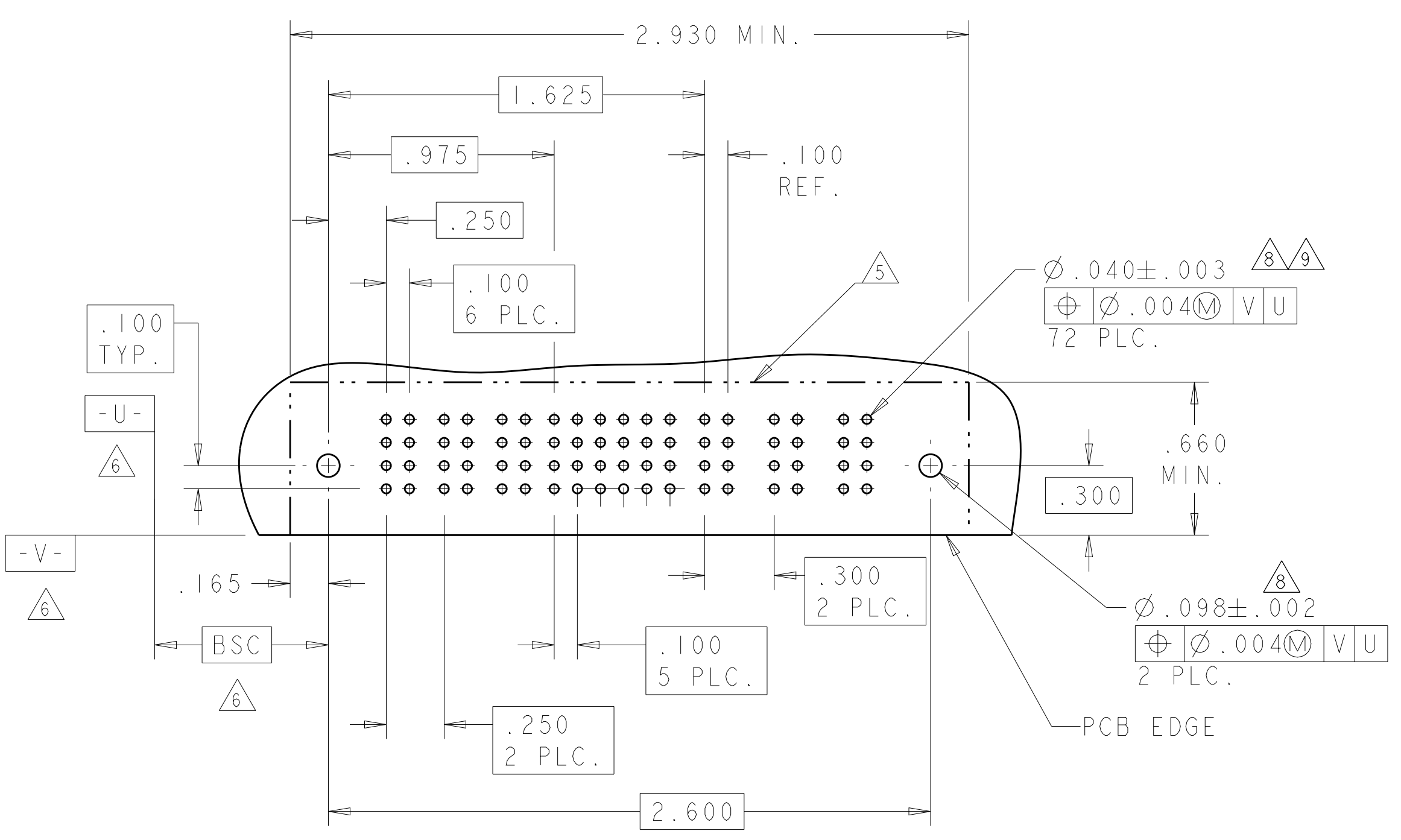

PART NUMBER	ROWS	POWER		SIGNAL						POWER
		P1	P2	1	2	3	4	5	6	P2
1-6450130-1	D C B A	PA	PA	A4	A4	A4	A4	A4	A4	PA
				A3	A3	A3	A3	A3	A3	
				A2	A2	A2	A2	A2	A2	
				A1	A1	A1	A1	A1	O	

1P + 24S + 1P

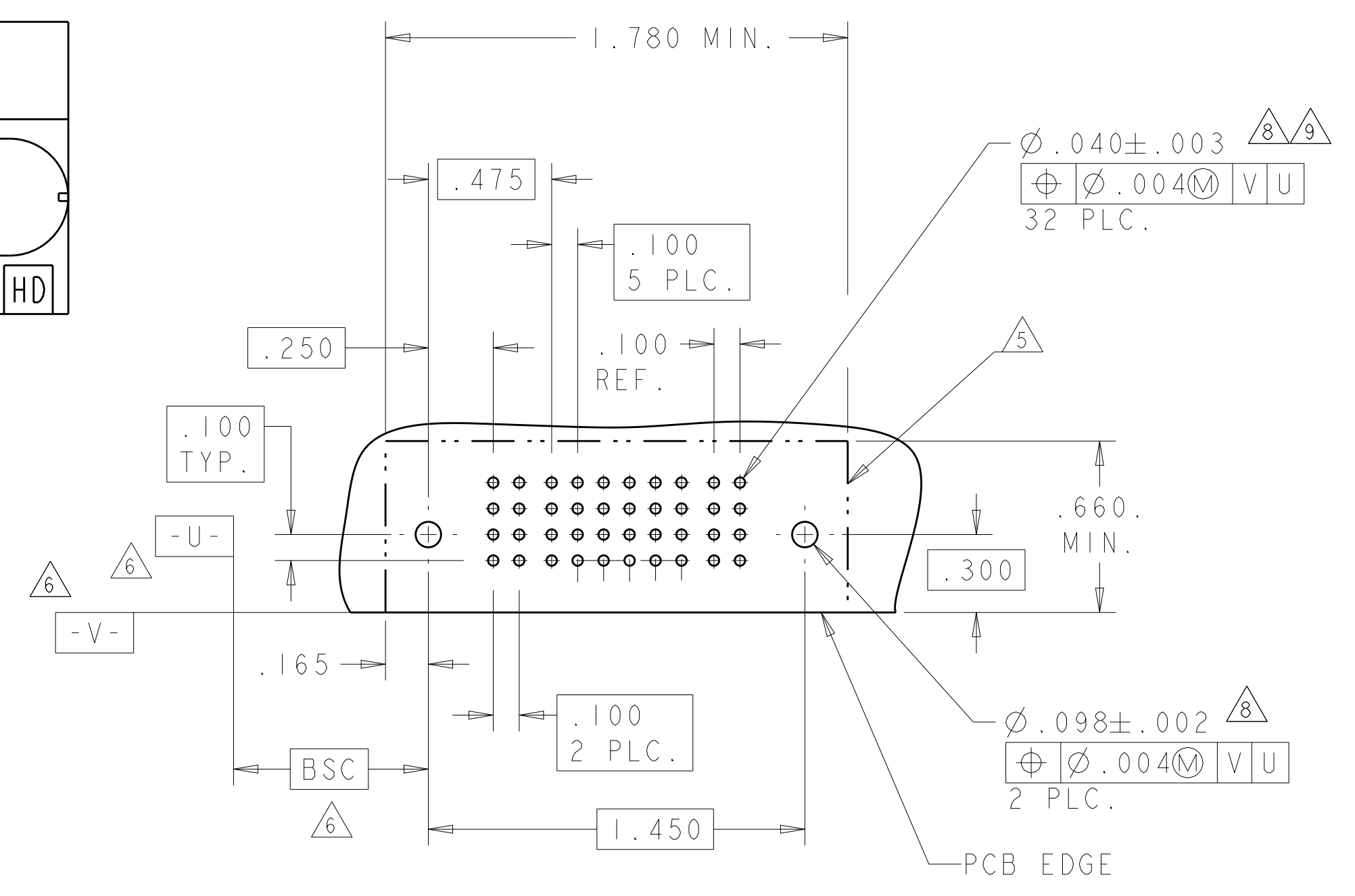

THIS DRAWING IS A CONTROLLED DOCUMENT.

DIMENSIONS: INCHES	TOLERANCES UNLESS OTHERWISE SPECIFIED:	OWN: R. GRZYBOWSKI 4 FEB 2005	CHK: M. PERCHERKE 14 FEB 2005	APVD: M. PERCHERKE 14 FEB 2005	NAME: RIGHT ANGLE HEADER ASSEMBLY W/GUIDES MULTI-BEAM XL
0 PLC ± .01 2 PLC ± .01 3 PLC ± .01 4 PLC ± .005 5 PLC ± .002 ANGLES ± .002		PRODUCT SPEC: 108-1973	APPLICATION SPEC: 114-13038	WEIGHT: -	SIZE: A100779
MATERIAL: -	FINISH: -	Customer Drawing		SCALE: 4:1	SHEET 5 OF 28

STE TE Connectivity

LOC		DIST		REVISIONS			
ES	00	P	LTM	DESCRIPTION	DATE	OWN	APVD
-	-	-	-	SEE SHEET 1	-	-	-

PART NUMBER	ROWS	POWER							SIGNAL						POWER						
		P1	P2	P3	P4	P5	P6	P7	P8	1	2	3	4	5	6	P9	P10	P11	P12	P13	
I-6450130-8	D	PM	PM	PM	PM	PM	PM	PM	E	J	J	J	J	E	PM	PM	PM	PM	PM		
	K								K	F	K	K	K								
	N								N	N	G	N	N								
	H								S	S	S	S	H								
2ACP + 6P + 24S + 5P																					

PART NUMBER	ROWS	POWER		SIGNAL																												POWER							
		P1	P2	1	2	3	4	5	6	7	8	9	10	11	12	13	14	15	16	17	18	19	20	21	22	23	24	25	26	27	28	29	30	31	P3	P4			
I-6450130-9	D	PA	PA	Z	A4	A4	A4	A4	A4	A4	A4	A4	A4	A4	A4	A4	A4	A4	A4	A4	A4	A4	A4	A4	A4	A4	A4	A4	A4	A4	A4	A4	A4	A4	Z	PA	PA		
	Y			A3	A3	A3	A3	A3	A3	A3	A3	A3	A3	A3	A3	A3	A3	A3	A3	A3	A3	A3	A3	A3	A3	A3	A3	A3	A3	A3	A3	A3	A3	A3	A3			Y	
	R			A2	A2	A2	A2	A2	A2	A2	A2	A2	A2	A2	A2	A2	A2	A2	A2	A2	A2	A2	A2	A2	A2	A2	A2	A2	A2	A2	A2	A2	A2	A2	A2			R	A2
	A			A1	A1	A1	A1	A1	A1	A1	A1	A1	A1	A1	A1	A1	A1	A1	A1	A1	A1	A1	A1	A1	A1	A1	A1	A1	A1	A1	A1	A1	A1	A1	A1			A1	A1
2P + 124S + 2P																																							

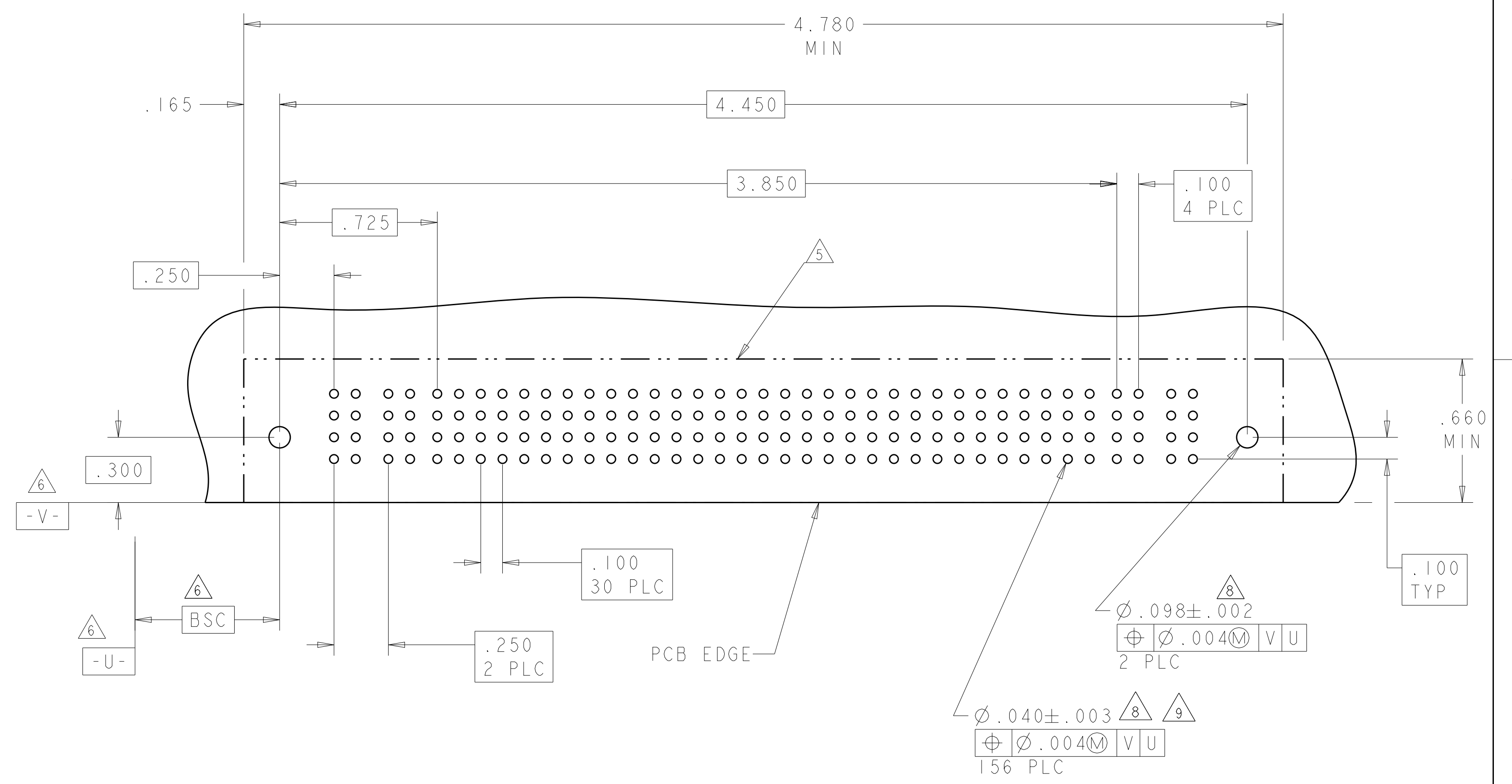
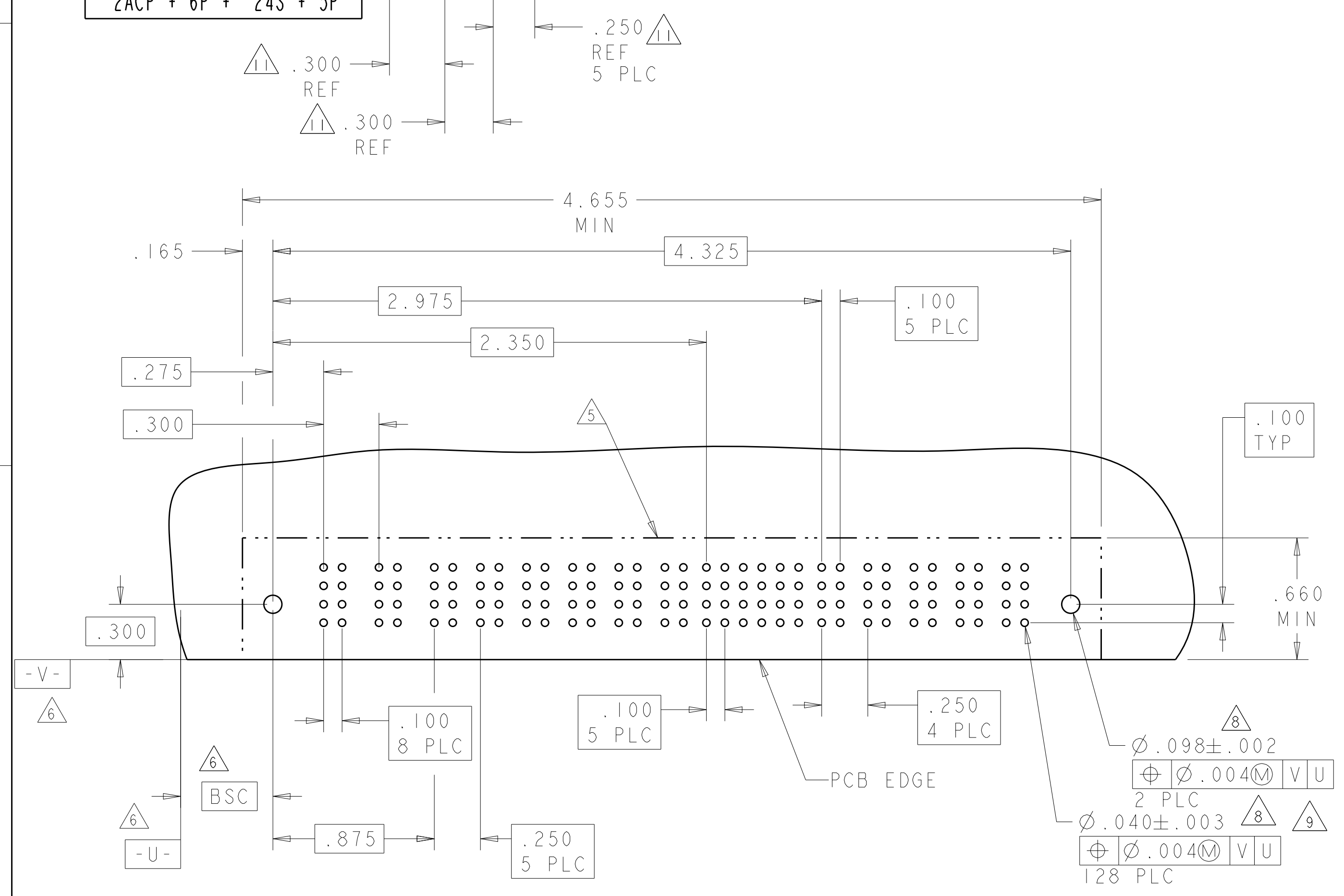

THIS DRAWING IS A CONTROLLED DOCUMENT.		OWN: R. GRZYBOWSKI 14FEB2005	 TE Connectivity												
DIMENSIONS: INCHES		CHK: M. PERCZERKE 14FEB2005													
TOLERANCES UNLESS OTHERWISE SPECIFIED:		APVD: M. PERCZERKE 14FEB2005	NAME: RIGHT ANGLE HEADER ASSEMBLY W/GUIDES MULTI-BEAM XL												
<table border="1"> <tr><td>0 PLC</td><td>±.</td></tr> <tr><td>1 PLC</td><td>±.01</td></tr> <tr><td>2 PLC</td><td>±.01</td></tr> <tr><td>3 PLC</td><td>±.005</td></tr> <tr><td>4 PLC</td><td>±.0020</td></tr> <tr><td>ANGLES</td><td>±.0020</td></tr> </table>		0 PLC	±.	1 PLC	±.01	2 PLC	±.01	3 PLC	±.005	4 PLC	±.0020	ANGLES	±.0020	PRODUCT SPEC: 108-1973	SIZE: A1
0 PLC	±.														
1 PLC	±.01														
2 PLC	±.01														
3 PLC	±.005														
4 PLC	±.0020														
ANGLES	±.0020														
MATERIAL: -		APPLICATION SPEC: 114-13038	CAGE CODE: -												
FINISH: -		WEIGHT: -	DRAWING NO: 6450130												
		Customer Drawing	SCALE: 4:1 SHEET 7 OF 28 REV: M2												

LOC	DIST	REV	DATE	BY	APPV
ES	00				

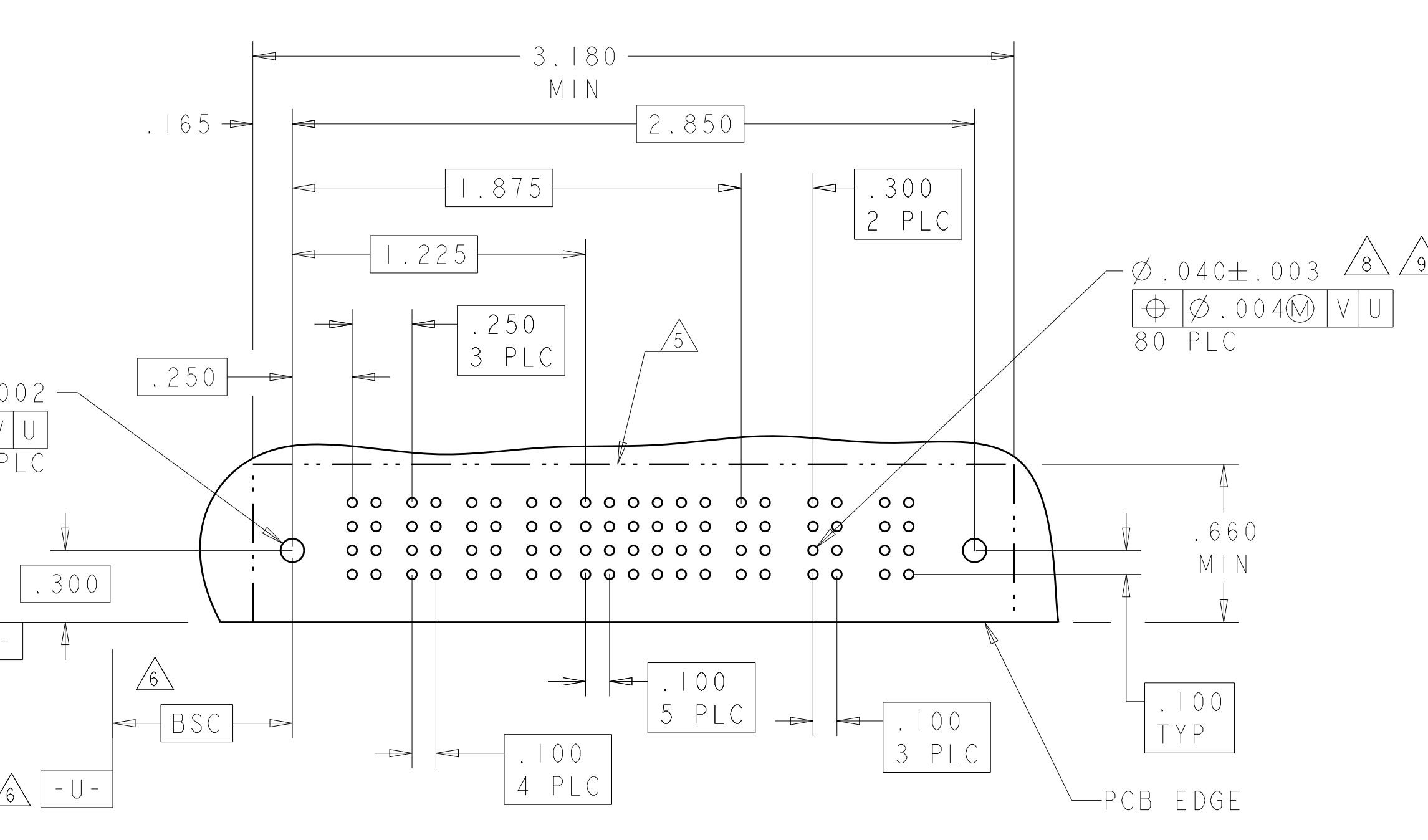
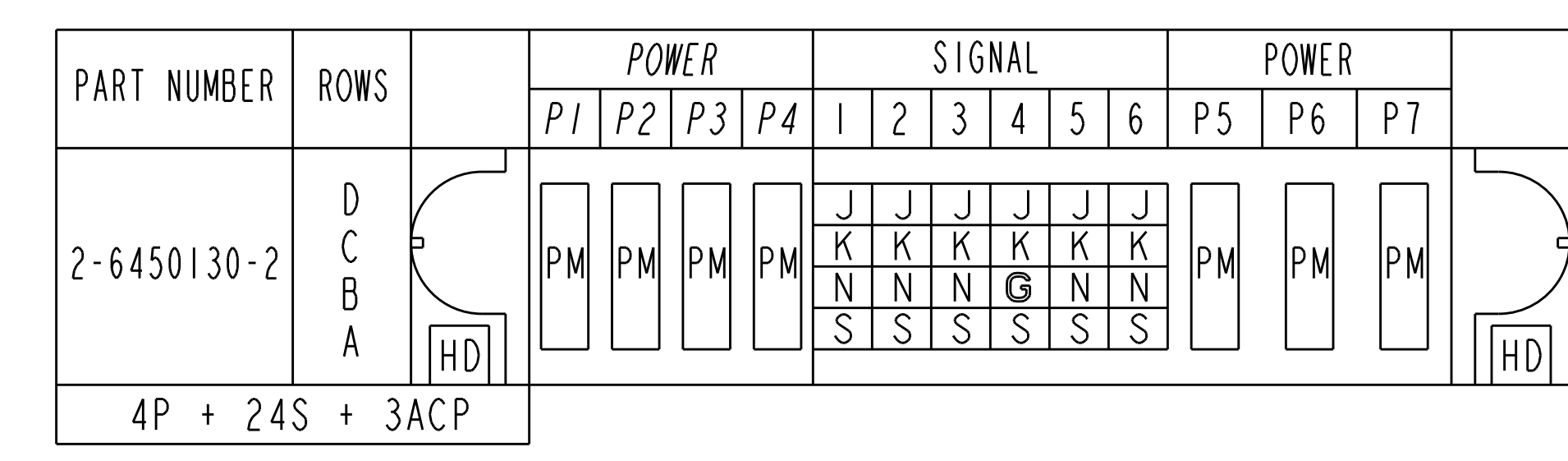
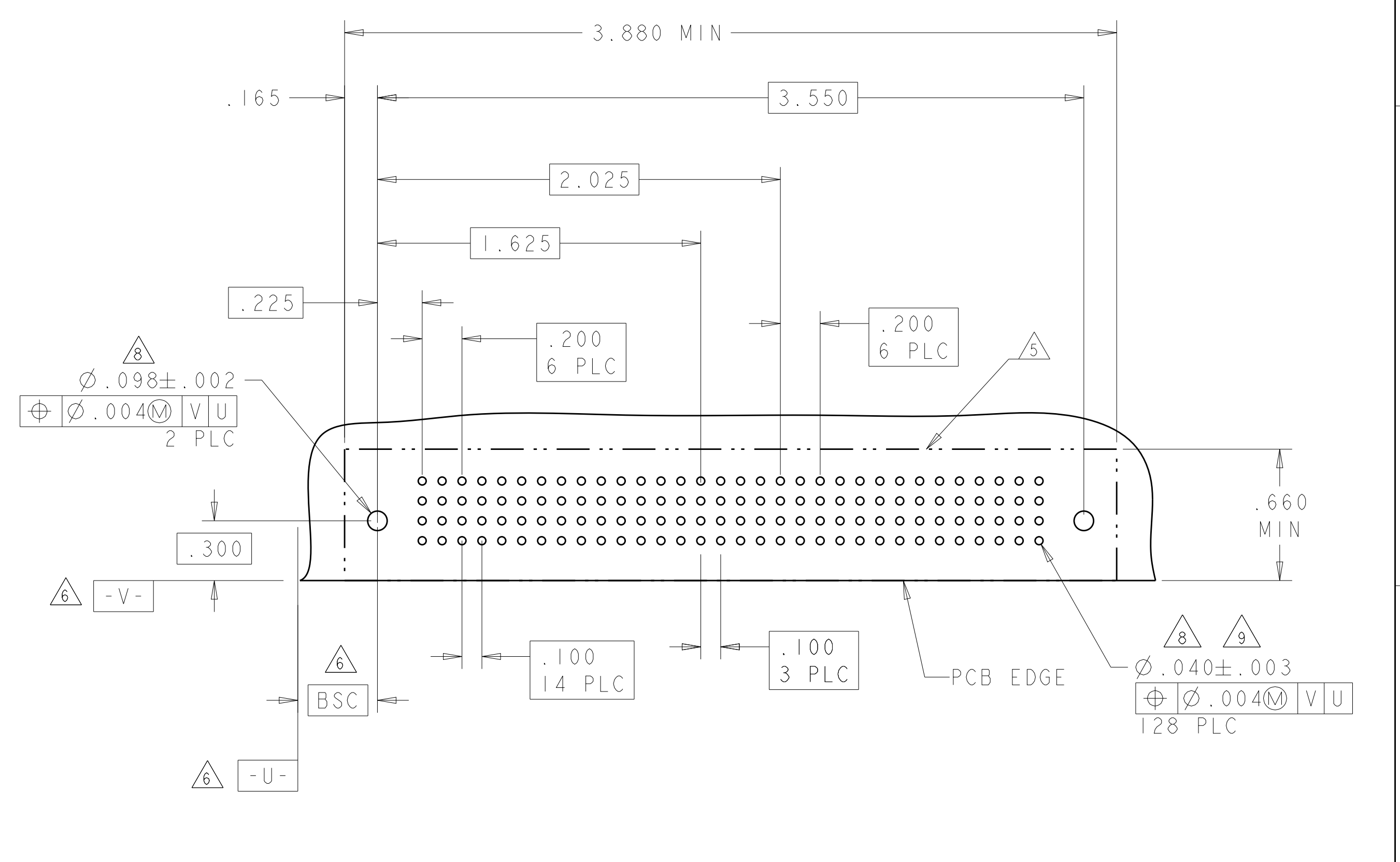
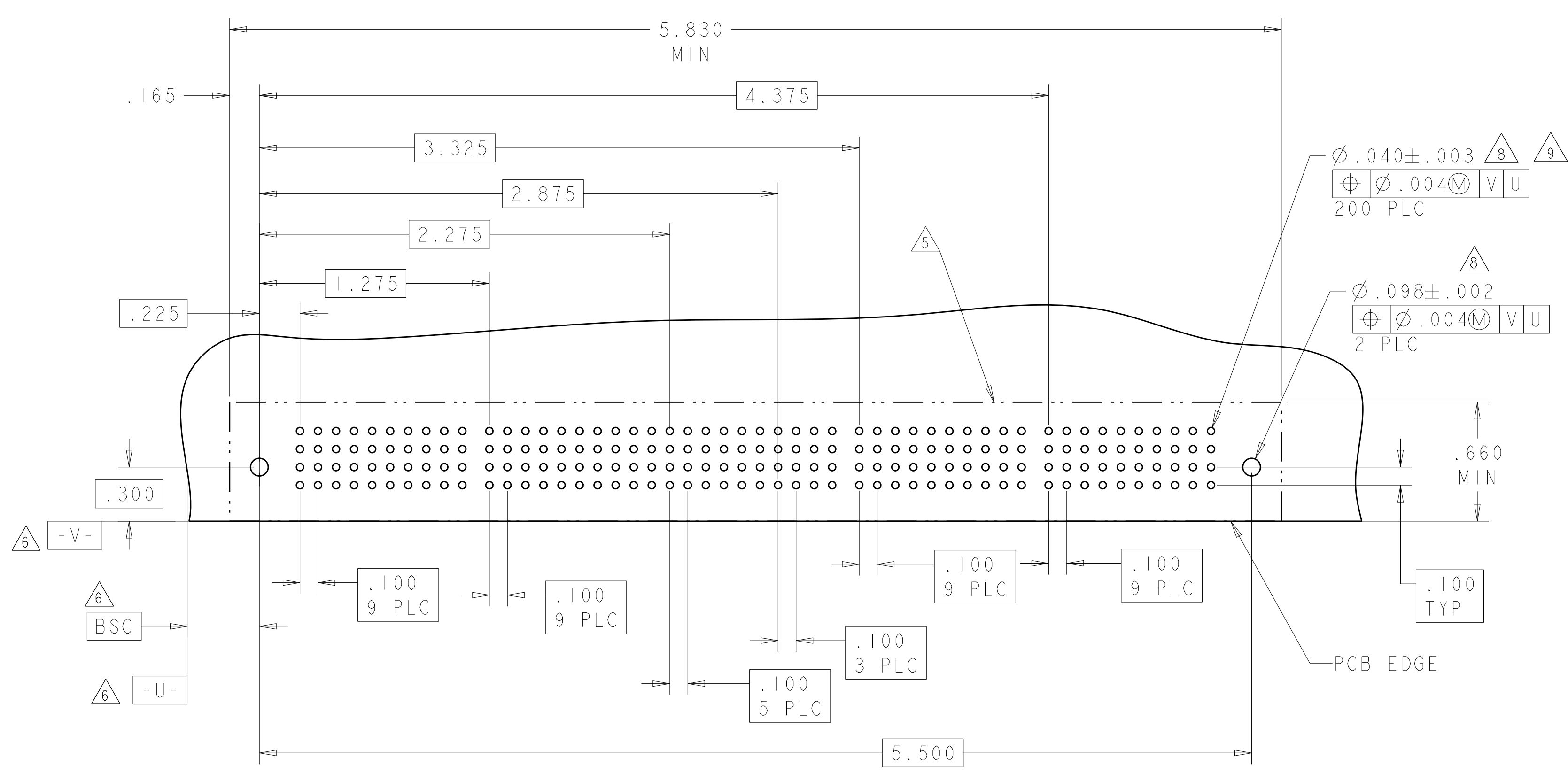
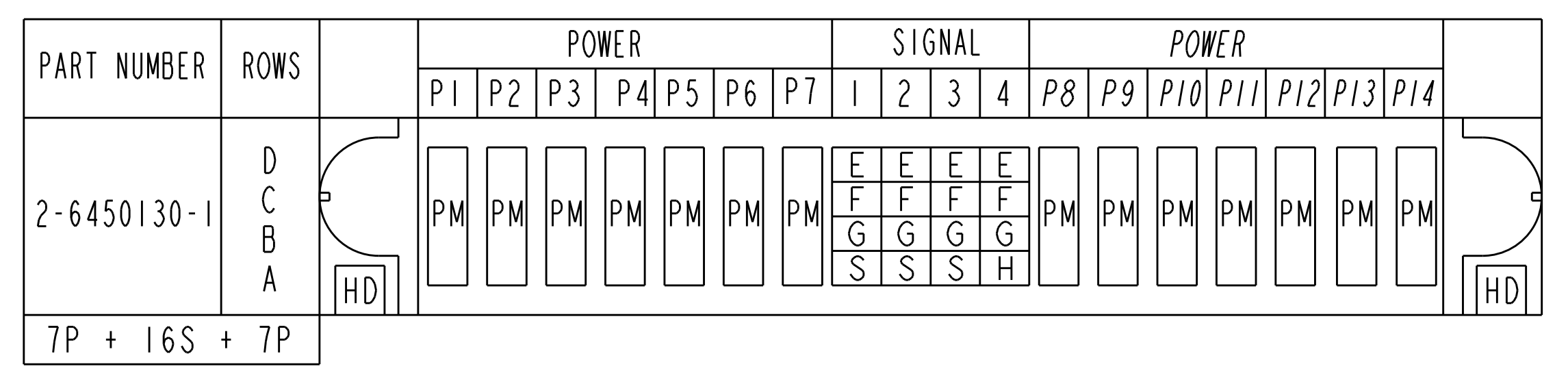
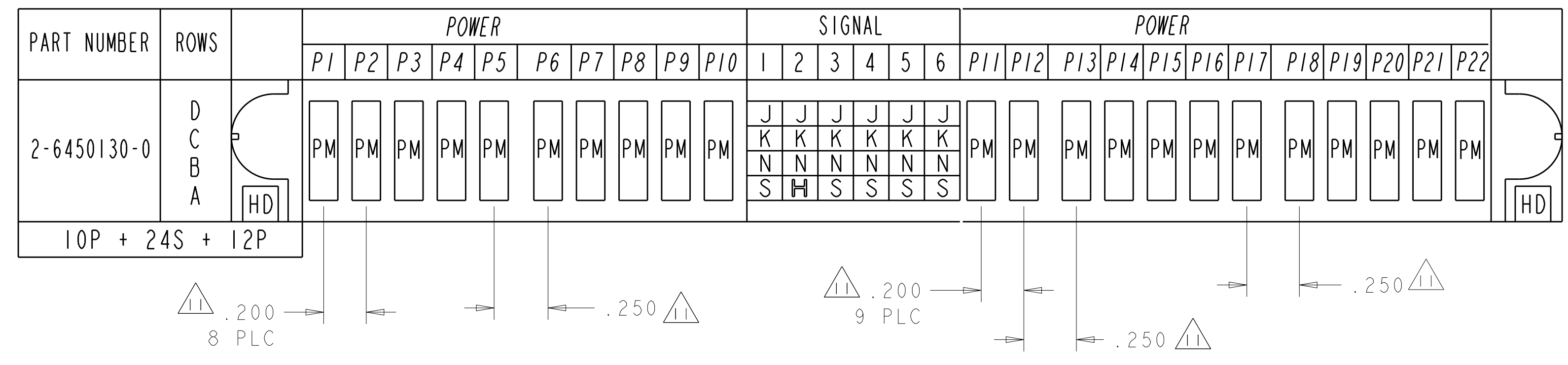

THIS DRAWING IS A CONTROLLED DOCUMENT.

DIMENSIONS: INCHES	TOLERANCES UNLESS OTHERWISE SPECIFIED:	OWN: R. GRZYBOWSKI 14FEB2005	CHK: M. PERCHERKE 14FEB2005	APV: M. PERCHERKE 14FEB2005
0 PLC ±.01	1 PLC ±.01	2 PLC ±.01	3 PLC ±.01	4 PLC ±.01
5 PLC ±.005	6 PLC ±.005	7 PLC ±.005	8 PLC ±.005	9 PLC ±.005
ANGLES ±.020	FINISH	PRODUCT SPEC: 108-1973	APPLICATION SPEC: 114-13038	WEIGHT
MATERIAL		SIZE: A1	CAGE CODE: 6450130	DRAWING NO: 100779
		Customer Drawing	SCALE: 4:1	SHEET: 8 OF 28

STE TE Connectivity

RIGHT ANGLE HEADER ASSEMBLY W/GUIDES MULTI-BEAM XL

PART NUMBER	ROWS	POWER			SIGNAL													POWER									
		P1	P2	P3	1	2	3	4	5	6	7	8	9	10	11	12	13	14	15	16	17	P4	P5				
2-6450130-8	D C B A	PM	PM	PM	J	J	J	J	J	J	J	J	J	J	J	J	J	J	J	J	J	J	J	PM	PM		
					K	K	K	K	K	K	K	K	K	K	K	K	K	K	K	K	K	K	K			K	K
					N	N	N	N	N	N	N	N	N	N	N	N	N	N	N	N	N	N	N			N	N
3P + 68S + 2P					S	S	S	S	S	S	S	S	S	S	S	S	S	S	S	S	S	S	S				

PART NUMBER	ROWS	POWER					SIGNAL								POWER														
		P1	P2	P3	P4	P5	1	2	3	4	5	6	7	8	9	10	11	12	P6	P7	P8								
3-6450130-2	D C B A	PM	PM	PM	PM	J	J	J	J	J	J	J	J	J	J	J	J	J	J	J	J	J	J	PM	PM	PM			
						K	K	K	K	K	K	K	K	K	K	K	K	K	K	K	K	K	K				K	K	K
						N	N	N	N	N	N	N	N	N	N	N	N	N	N	N	N	N	N				N	N	N
5P + 48S + 3P						H	S	S	S	S	S	S	S	S	S	S	S	S	S	S	S	H							

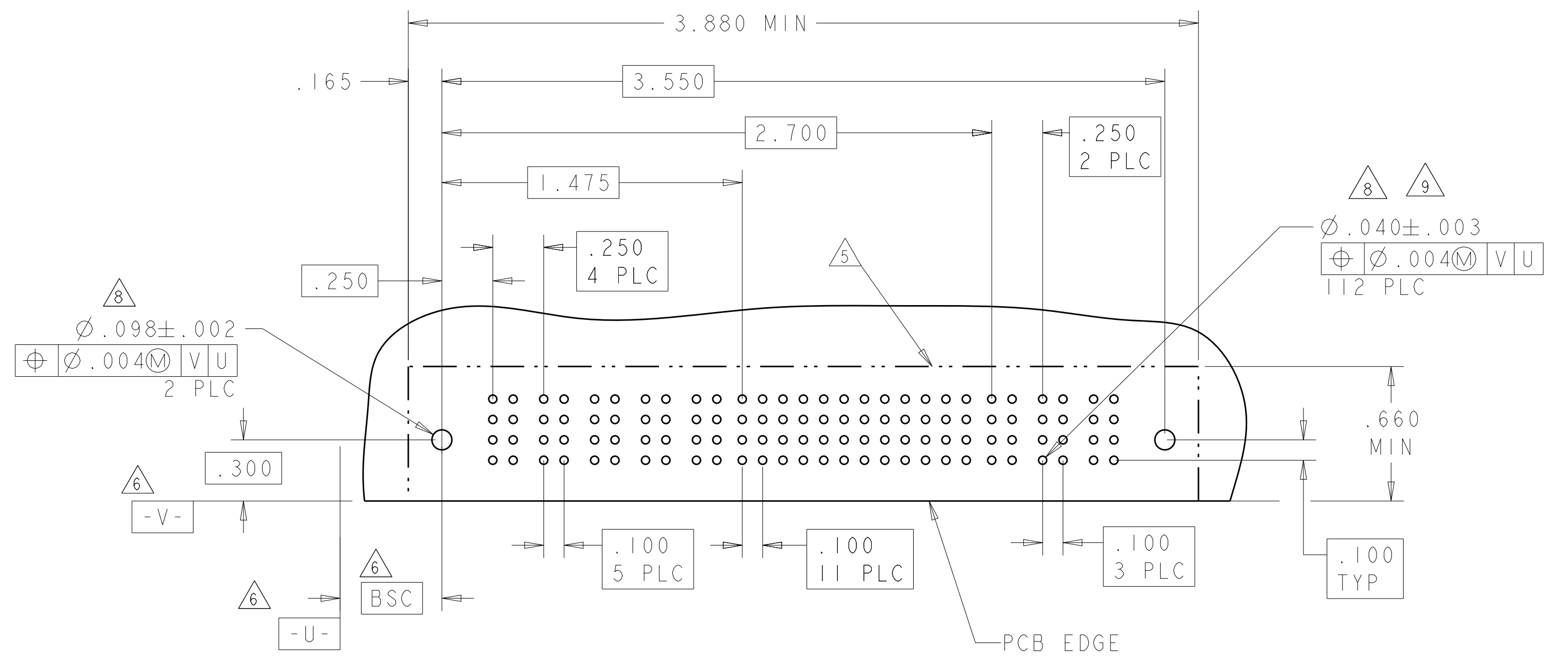
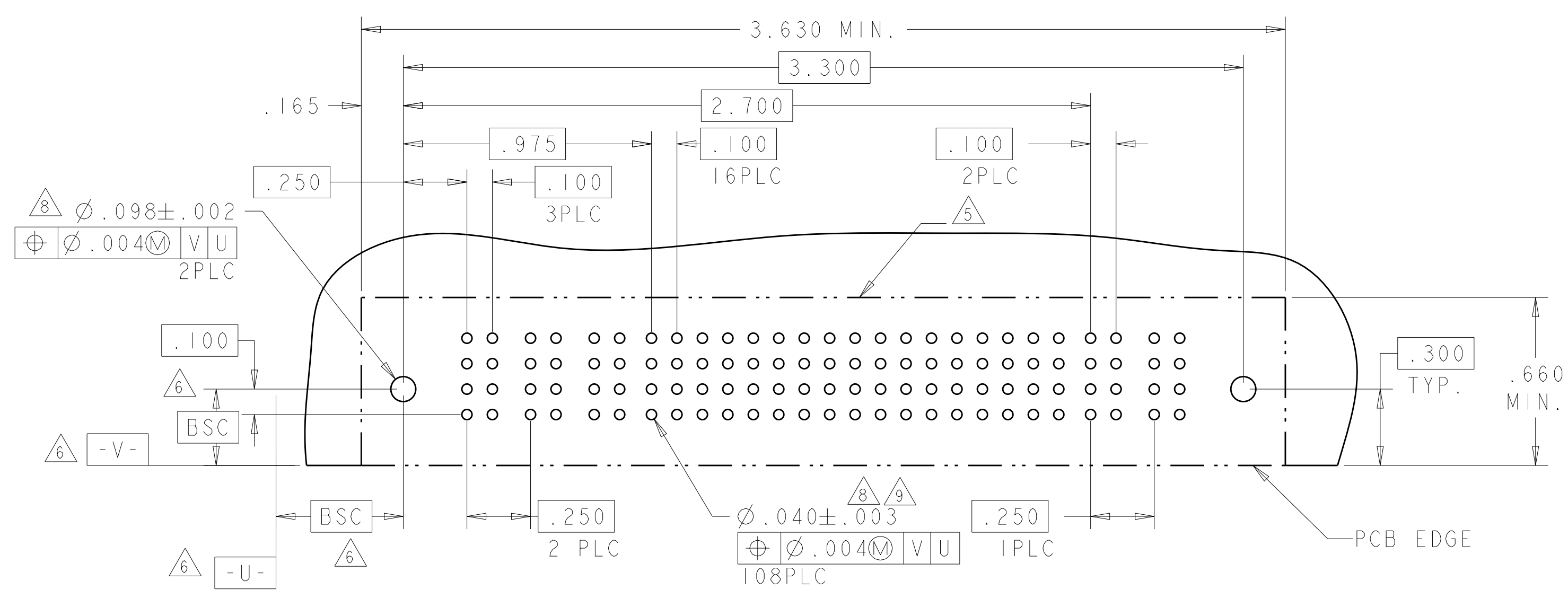

PART NUMBER	ROWS	POWER						SIGNAL					POWER													
		P1	P2	P3	P4	P5	P6	1	2	3	4	5	P7	P8	P9	P10	P11	P12								
2-6450130-3	D C B A	PM	PM	PM	PM	PM	E	J	J	J	J	PM	PM	PM	PM	PM	PM	PM	PM	PM	PM					
							F	K	K	K	K											F	K	K	K	K
							G	N	N	N	N											G	N	N	N	N
							H	S	S	S	S											H	S	S	S	S
6P + 20S + 6P																										

PART NUMBER	ROWS	POWER												SIGNAL					POWER															
		P1	P2	P3	P4	P5	P6	P7	P8	P9	P10	P11	P12	1	2	3	4	5	P13	P14	P15													
3-6450130-6	D C B A	PM	PM	PM	PM	PM	PM	PM	PM	PM	PM	PM	PM	PM	PM	PM	PM	PM	PM	PM	PM	PM	PM	PM										
																									E	E	J	J	J	PM	PM	PM	PM	PM
																									K	K	F	K	K					
																									N	N	N	N	N					
H	S	H	S	S																														
12P + 20S + 3ACP																																		

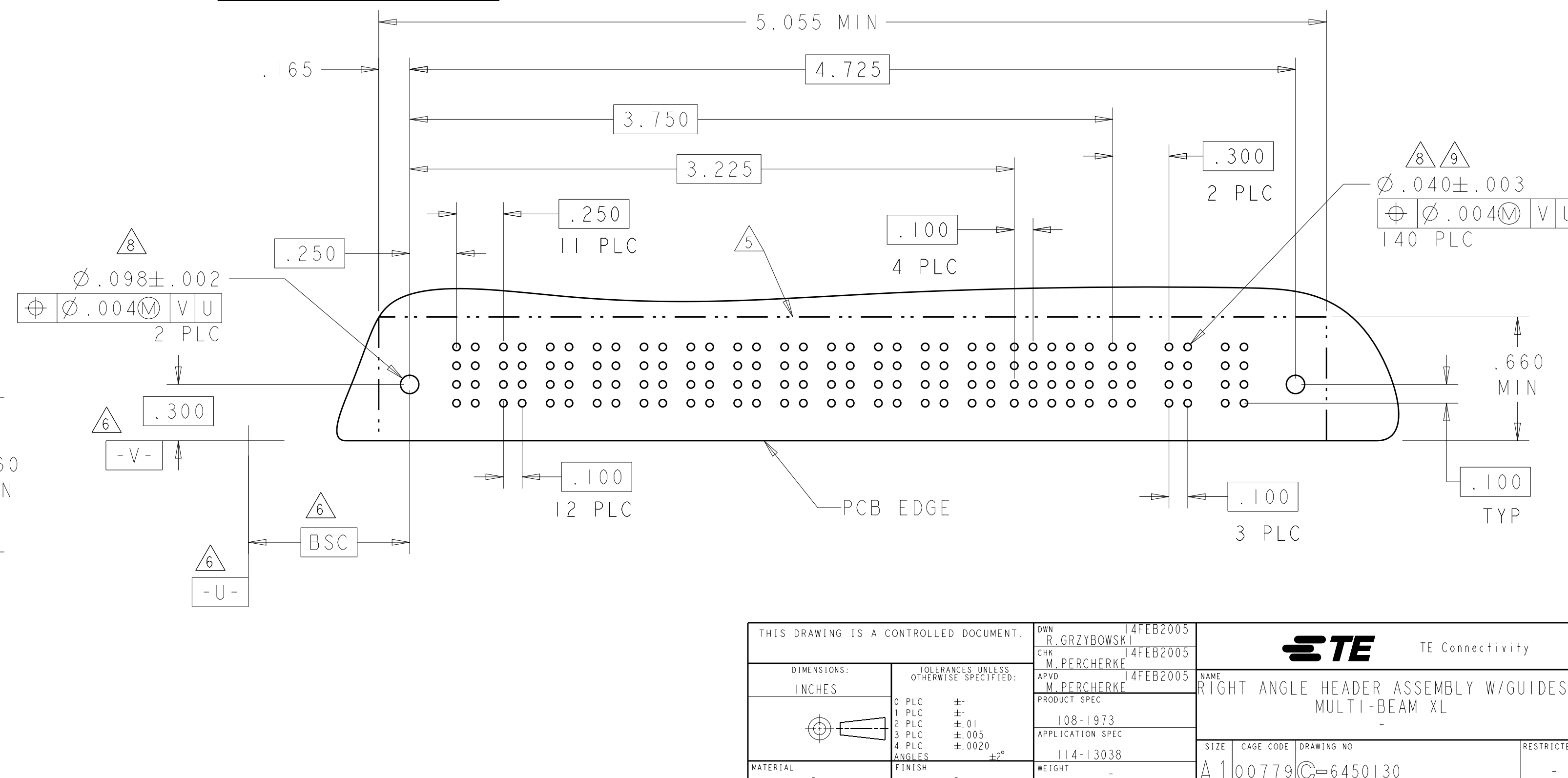
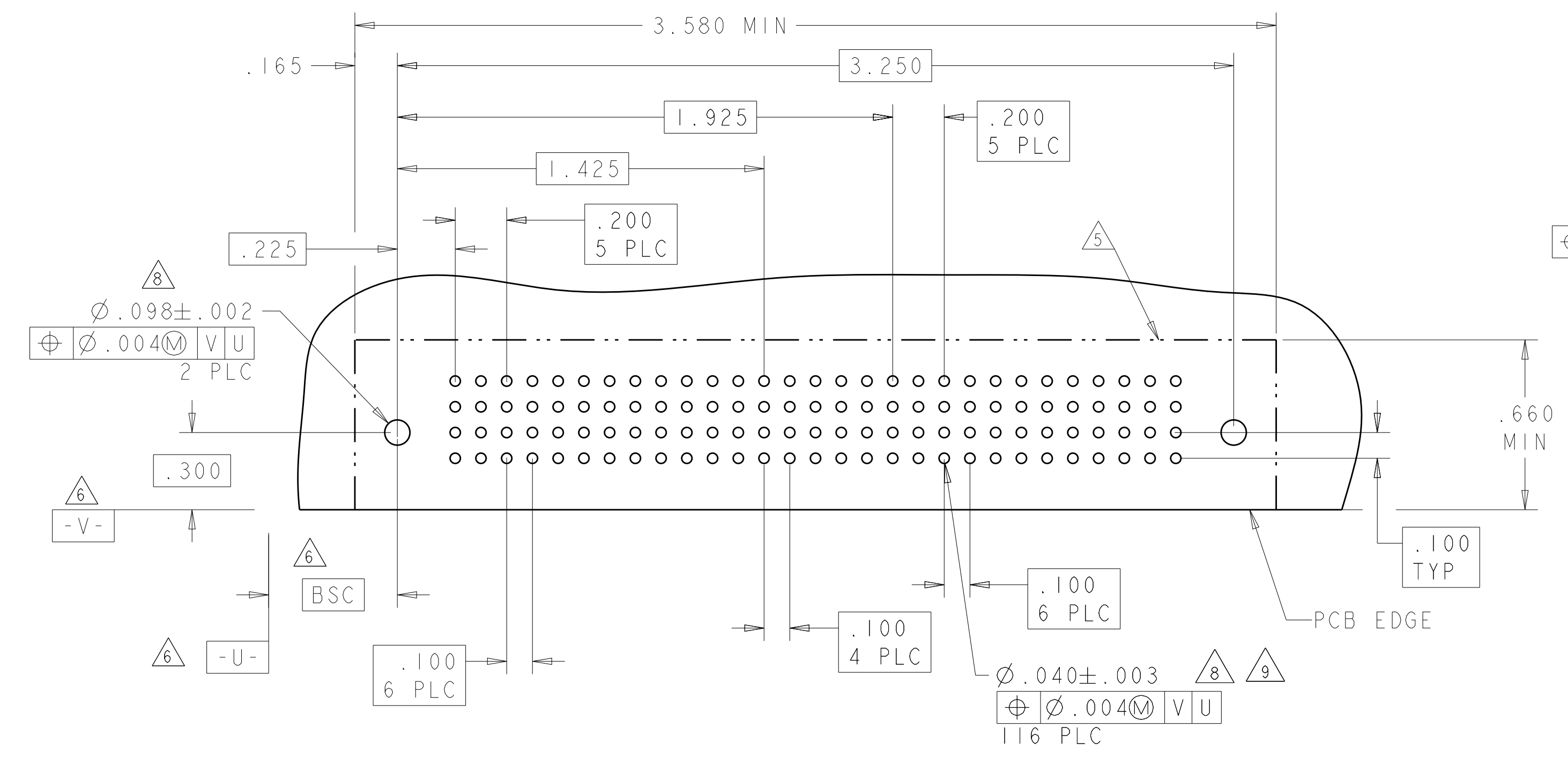

THIS DRAWING IS A CONTROLLED DOCUMENT. DWG: R.GRZYBOWSKI 14FEB2005
CHK: M.PERCHEK 14FEB2005
APPV: M.PERCHEK 14FEB2005

STE TE Connectivity

RIGHT ANGLE HEADER ASSEMBLY W/GUIDES MULTI-BEAM XL

Customer Drawing
SCALE: 4:1 SHEET 9 OF 28 REV M2

PART NUMBER	ROWS	POWER			SIGNAL				POWER	
		P1	P2	P3	1	2	3	4	P4	P5
3-6450130-9	D C B A	PM	PM	PM	J	J	J		PM	PM
					K	K	K			
					N	N	N			
					S	S	H			

3ACP + 16S + 2P

CONTACTS NOT LOADED

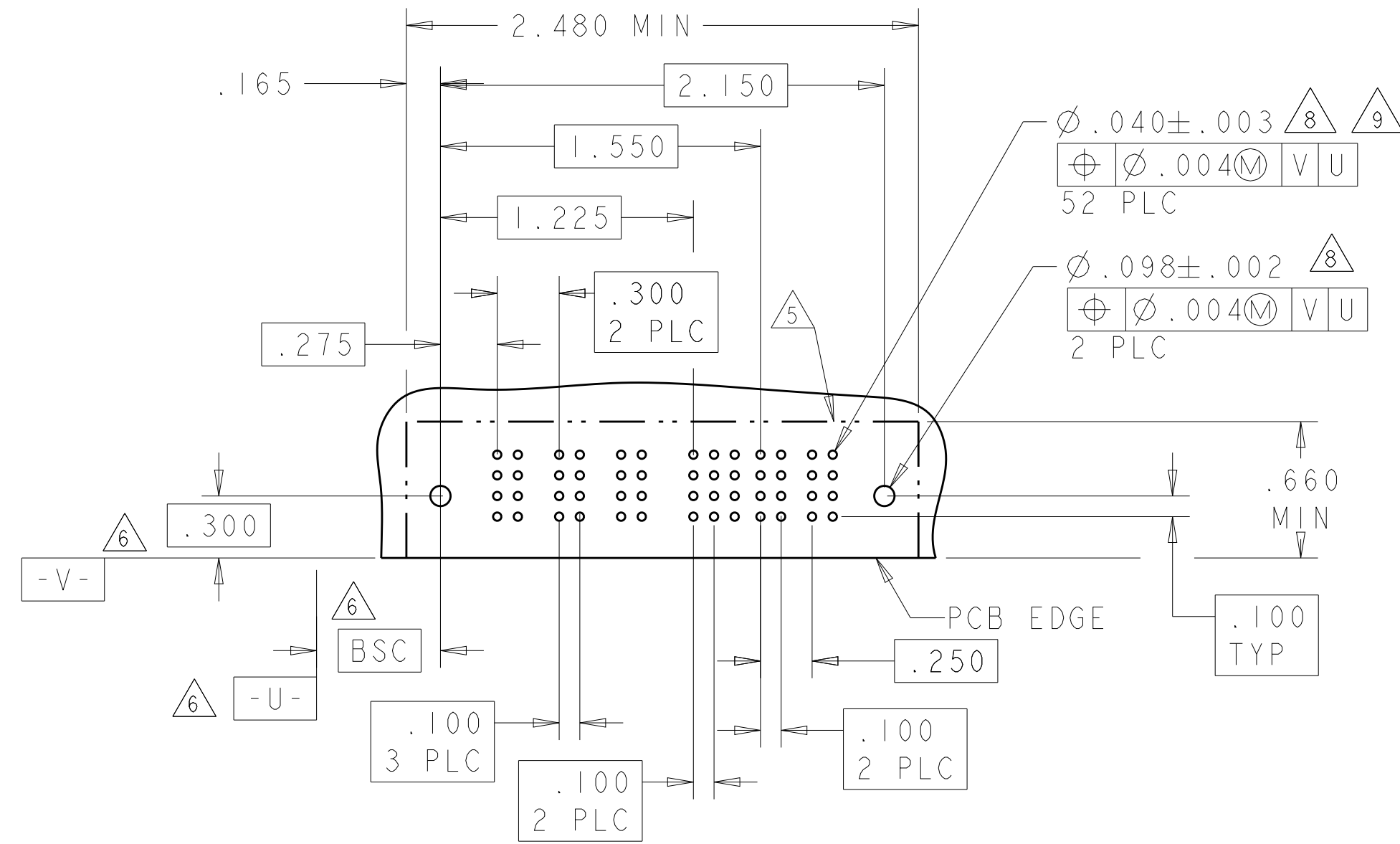

PART NUMBER	ROWS	POWER				SIGNAL				POWER			
		P1	P2	P3	P4	1	2	P5	P6	P7	P8		
4-6450130-0	D C B A	PA	PA	PA	PA	Z	Z	PA	PA	PA	PA		
						Y	Y						
						R	R						
						O	O						

4P + 8S + 4P

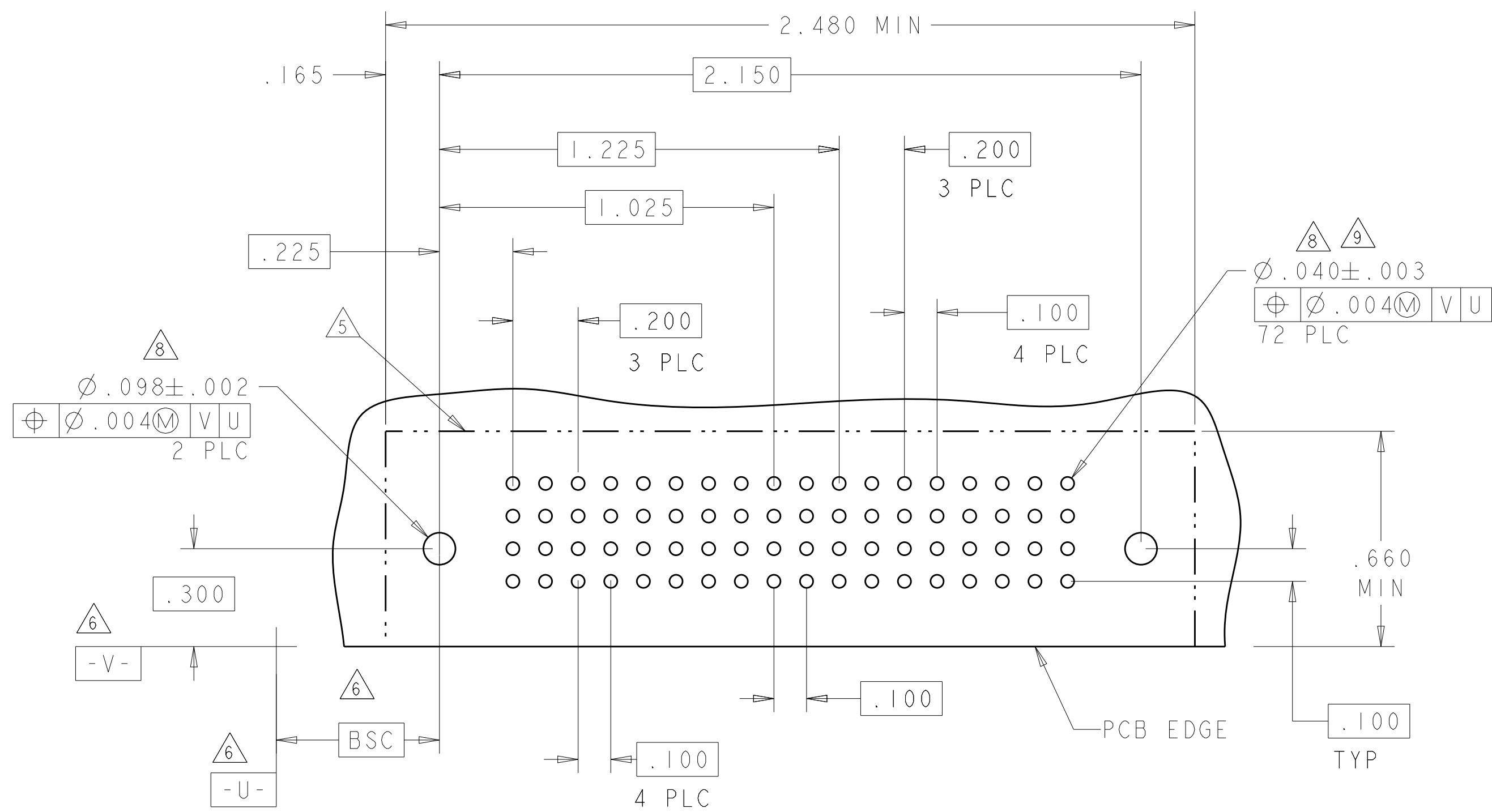

LOC	DIST	REV	DATE	BY	APPV
ES	00				

PART NUMBER	ROWS	POWER			SIGNAL				POWER	
		P1	P2	P3	1	2	3	4	P4	P5
4-6450130-3	D C B A			PM	J	J	J		PM	PM
					K	K	K			
					N	N	N			
					S	S	H			

3ACP + 16S + 2P

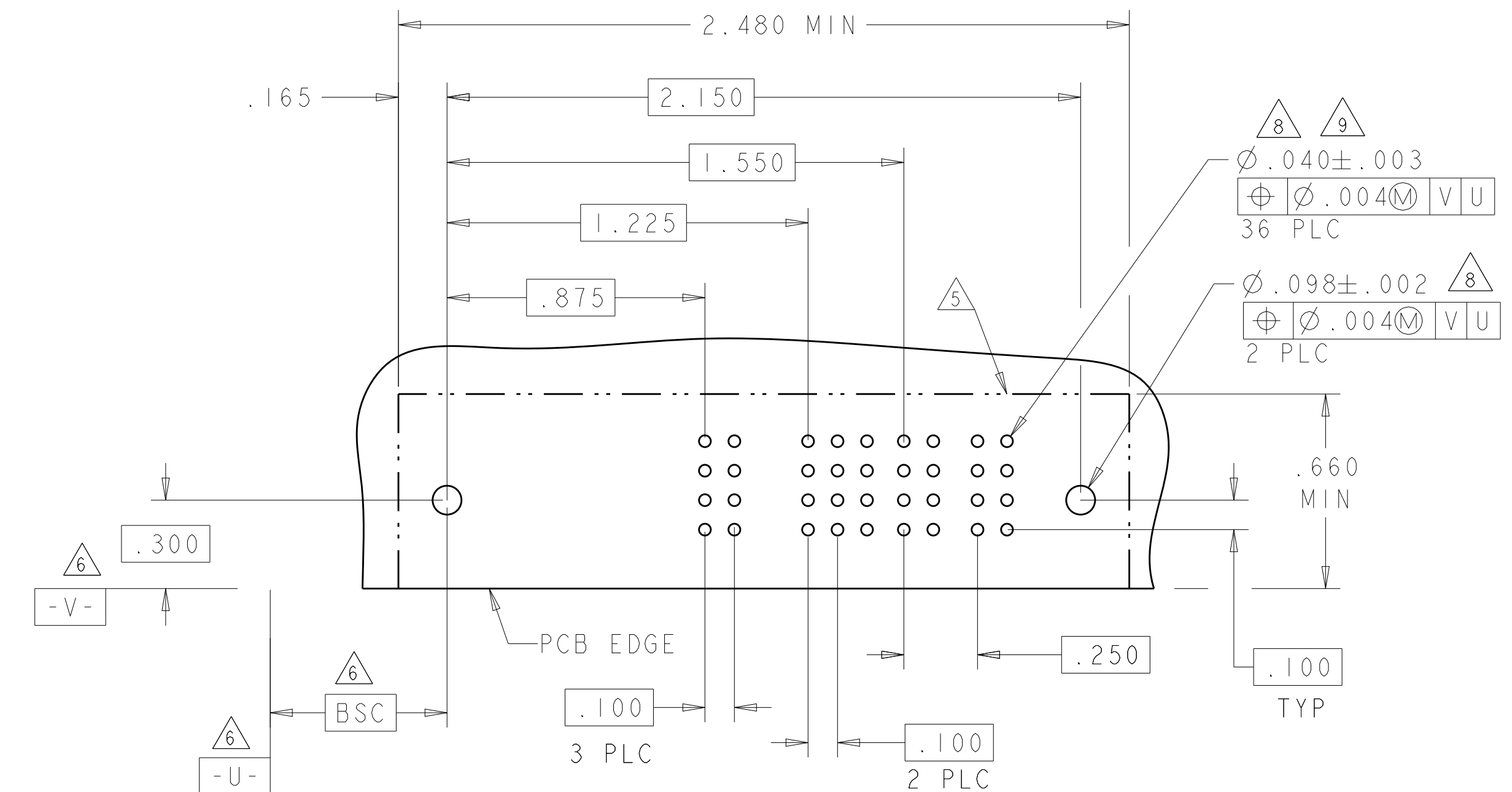

PART NUMBER	ROWS	POWER					SIGNAL								POWER				
		P1	P2	P3	P4	P5	1	2	3	4	5	6	7	8	P6	P7	P8	P9	P10
4-6450130-5	D C B A	PM	PM	PM	PM	PM	J	J	J	J	J	J	J	J	PM	PM	PM	PM	PM
							K	K	K	K	K	K	K						
							N	N	N	N	N	N	N						
							H	H	H	H	H	H	H						

5P + 32S + 5P

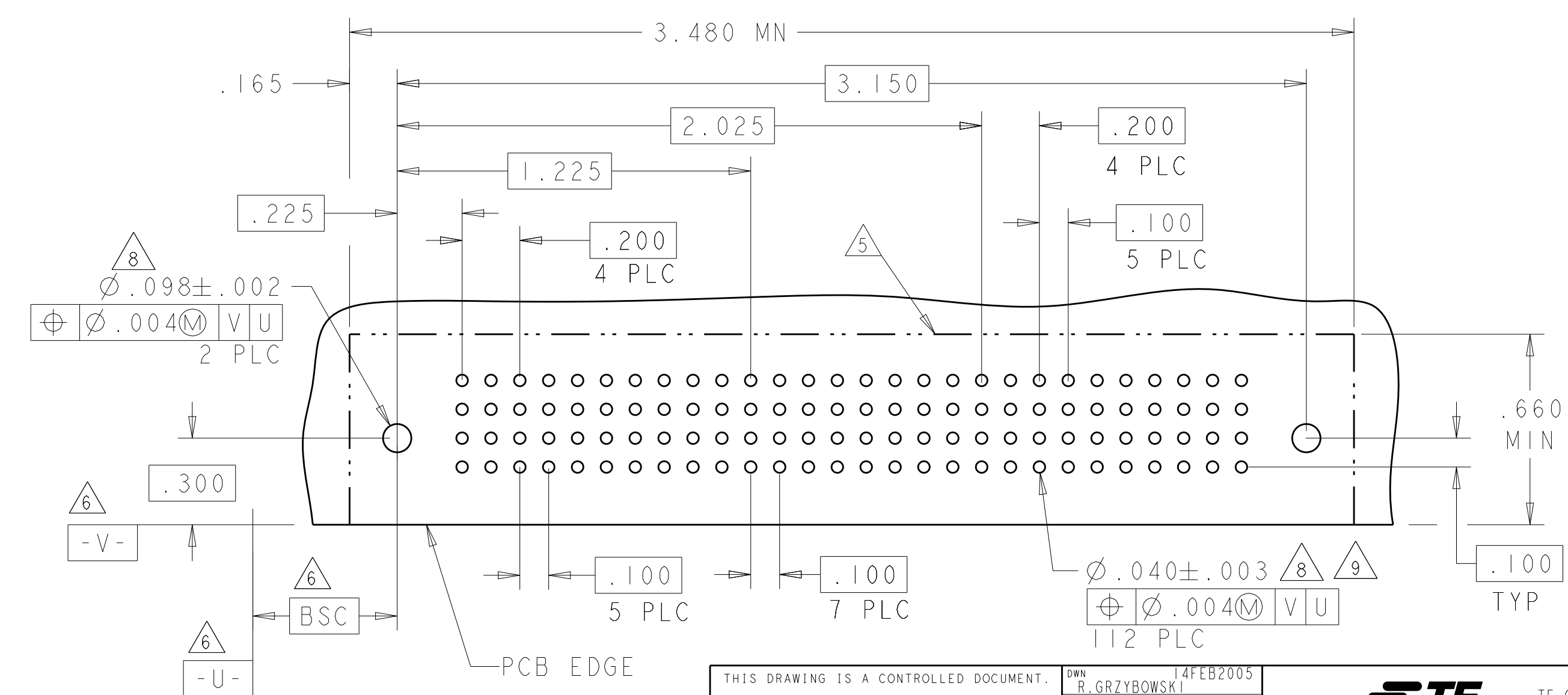

THIS DRAWING IS A CONTROLLED DOCUMENT.

OWN: R. GRZYBOWSKI 14FEB2005
CHK: M. PERCHERKE 14FEB2005
APPV: M. PERCHERKE 14FEB2005

TE Connectivity

RIGHT ANGLE HEADER ASSEMBLY W/GUIDES MULTI-BEAM XL

SCALE: 4:1 SHEET 10 OF 28 REV: M2

PART NUMBER	ROWS	POWER				SIGNAL										POWER									
		P1	P2	P3	P4	1	2	3	4	5	6	7	8	9	10	P5	P6	P7	P8						
4-6450130-8	D C B A	PM	PM	PM	PM	J	J	J	J	J	J	J	J	J	J	J	J	J	J	J	PM	PM	PM	PM	
						K	K	K	K	K	K	K	K	K	K	K	K	K	K	K					K
						N	N	N	N	N	N	N	N	N	N	N	N	N	N	N					N
4P + 40S + 4P																									

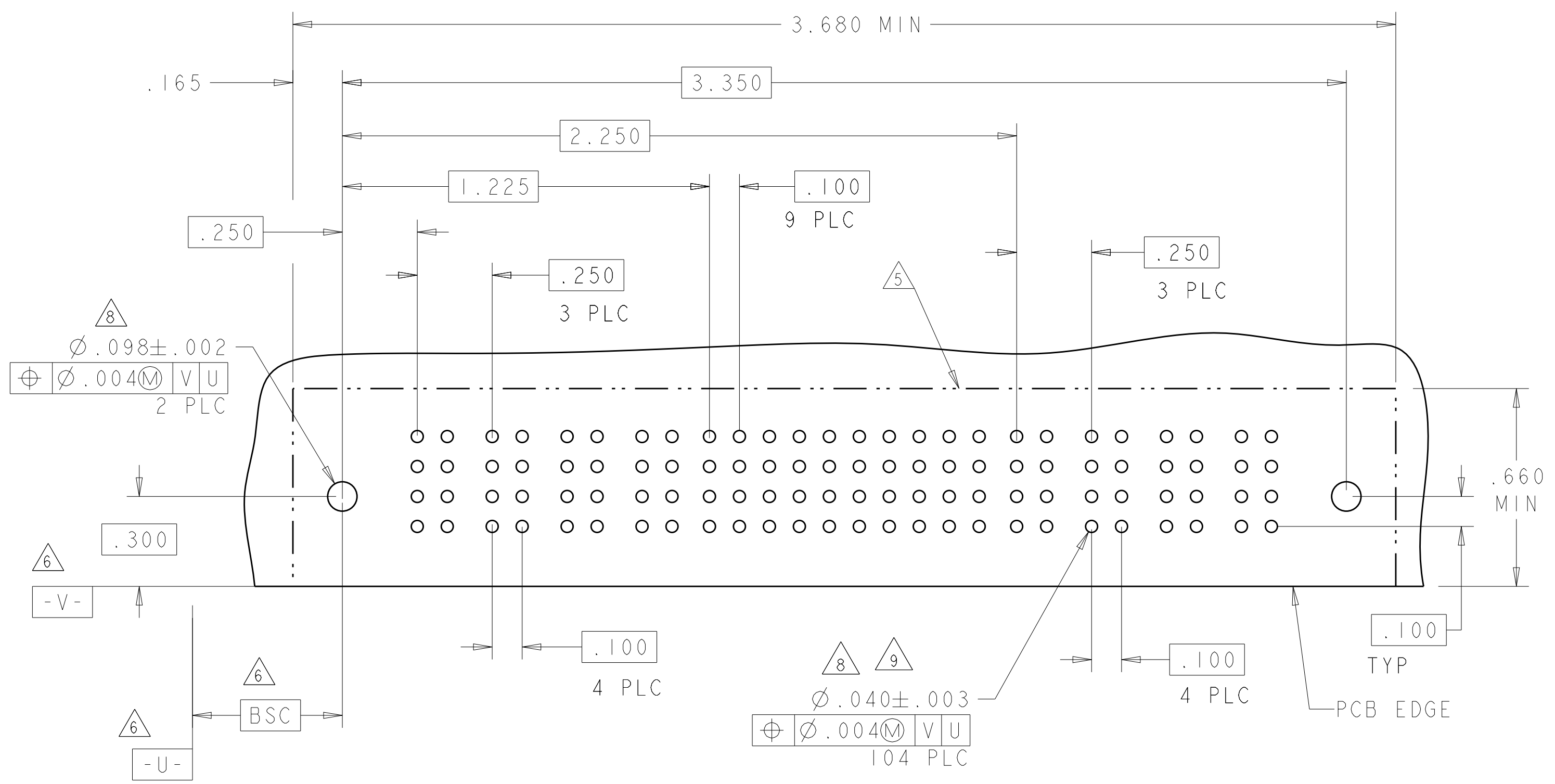

PART NUMBER	ROWS	POWER				SIGNAL								POWER											
		P1	P2	P3	P4	1	2	3	4	5	6	P5	P6	P7	P8										
4-6450130-9	D C B A	PM	PM	PM	PM	J	J	J	J	J	J	J	J	J	J	J	J	J	J	PM	PM	PM	PM		
						K	K	K	K	K	K	K	K	K	K	K	K	K	K					K	
						N	N	N	N	N	N	N	N	N	N	N	N	N	N					N	N
4P + 24S + 4P																									

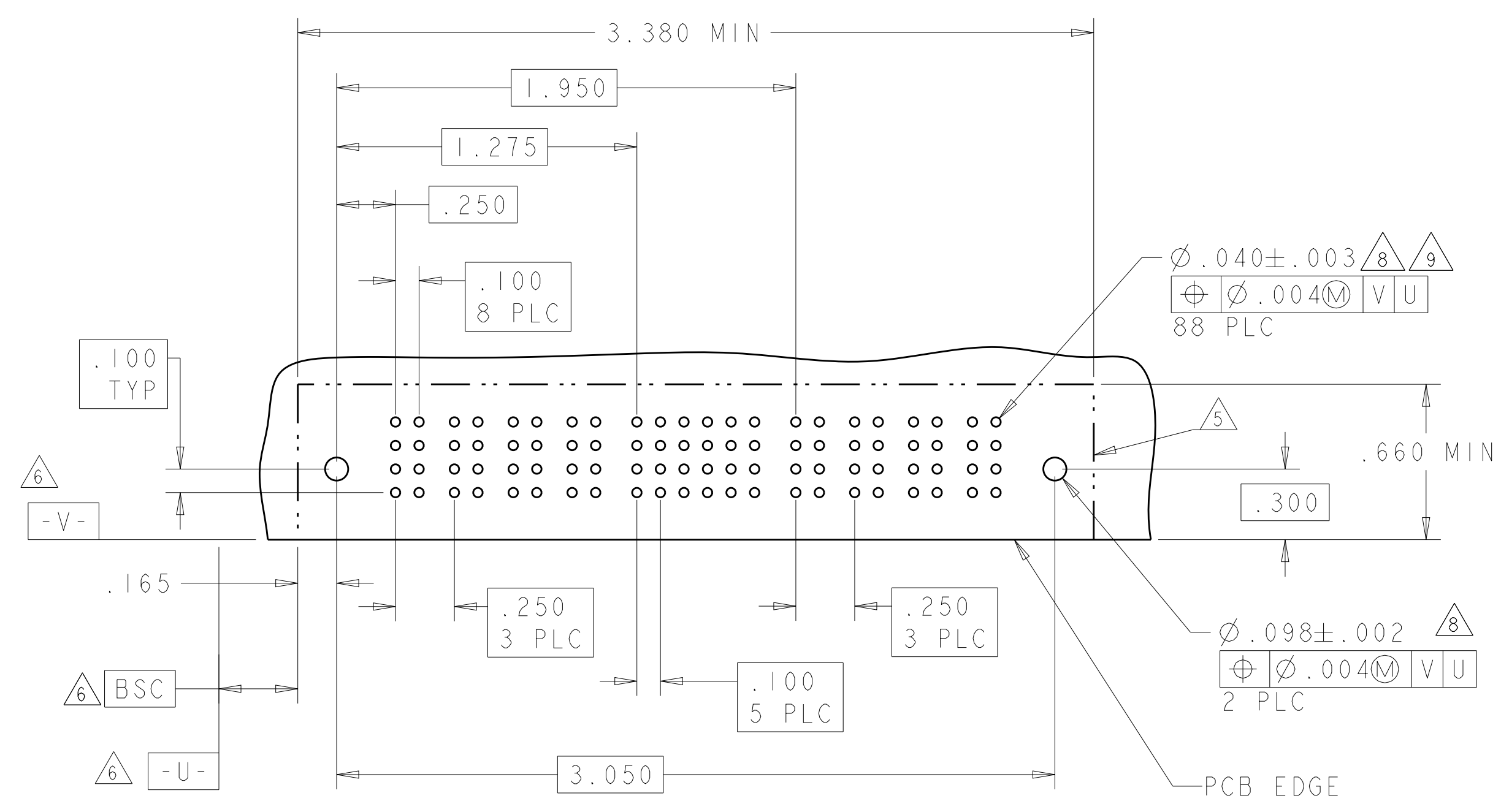

PART NUMBER	ROWS	POWER					SIGNAL										POWER																			
		P1	P2	P3	P4	P5	1	2	3	4	5	6	7	8	9	10	P6	P7	P8	P9	P10															
5-6450130-0	D C B A	PM	PM	PM	PM	PM	J	J	J	J	J	J	J	J	J	J	J	J	J	J	J	J	J	J	PM	PM	PM	PM	PM							
							K	K	K	K	K	K	K	K	K	K	K	K	K	K	K	K	K	K						K	K	K				
							N	N	N	N	N	N	N	N	N	N	N	N	N	N	N	N	N	N						N	N	N	N	N		
5ACP + 24S + 5ACP																																				

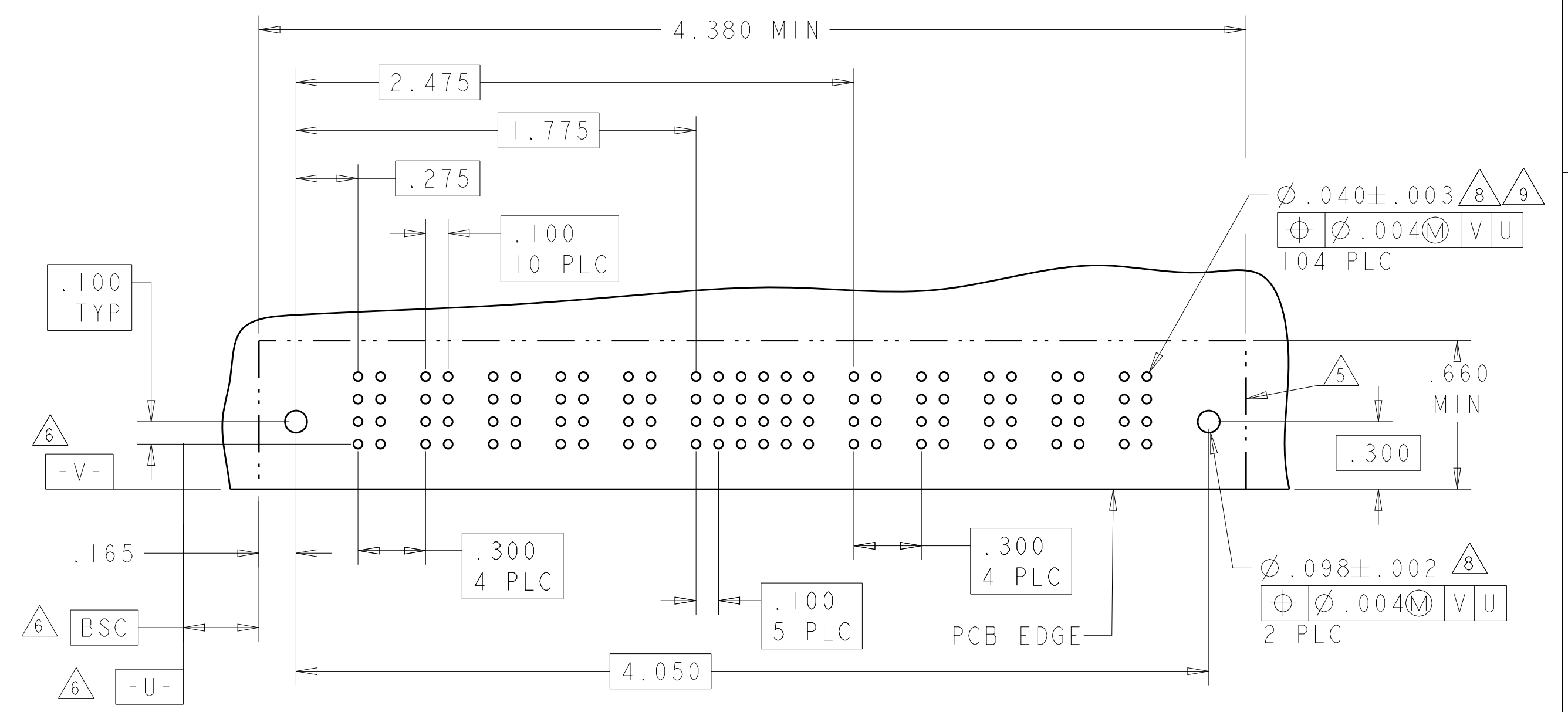

PART NUMBER	ROWS	POWER					SIGNAL								POWER																					
		P1	P2	P3	P4	P5	1	2	3	4	5	6	7	8	P6	P7	P8	P9	P10																	
5-6450130-5	D C B A	PM	PM	PM	PM	PM	J	J	J	J	J	J	J	J	J	J	J	J	J	J	J	J	J	J	PM	PM	PM	PM	PM							
							K	K	K	K	K	K	K	K	K	K	K	K	K	K	K	K	K	K						K	K	K				
							N	N	N	N	N	N	N	N	N	N	N	N	N	N	N	N	N	N						N	N	N	N	N		
5P + 32S + 5P																																				

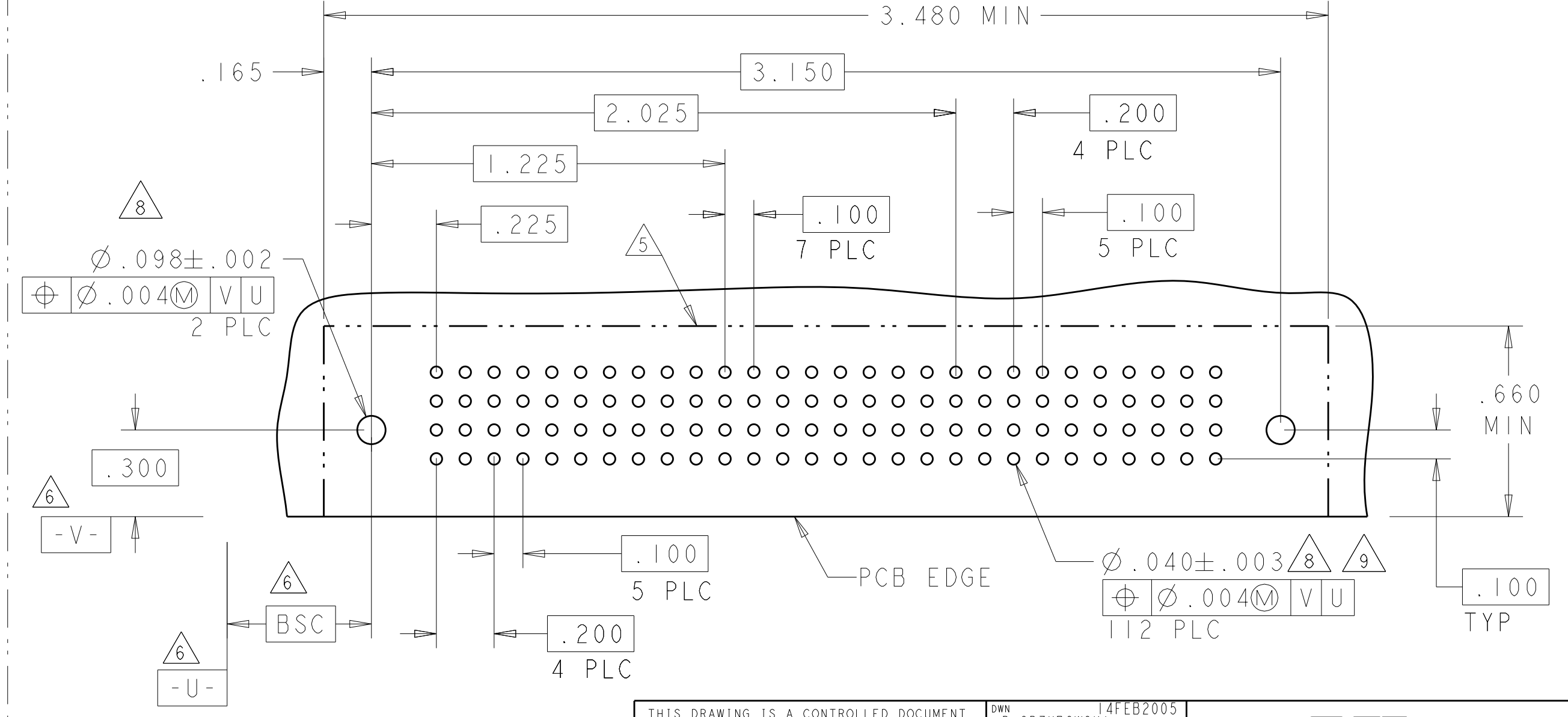

THIS DRAWING IS A CONTROLLED DOCUMENT.

DIMENSIONS: INCHES	TOLERANCES UNLESS OTHERWISE SPECIFIED:	0 PLC ±.01	1-4 PLC ±.005	5-8 PLC ±.002	ANGLES ±.020
MATERIAL:	FINISH:	DWN: R. GRZYBOWSKI 14FEB2005 CHK: M. PERCHERKE 14FEB2005 APPV: M. PERCHERKE 14FEB2005			
TE Connectivity		NAME: RIGHT ANGLE HEADER ASSEMBLY W/GUIDES MULTI-BEAM XL			
SCALE: 4:1		SHEET 11 OF 28			

PART NUMBER	ROWS	POWER																SIGNAL						POWER				
		P1	P2	P3	P4	P5	P6	P7	P8	P9	P10	P11	P12	P13	P14	P15	P16	1	2	3	4	5	6	P17	P18	P19	P20	P21
7-6450130-4	D C B A	PM	PM	PM	PM	PM	PM	PM	PM	PM	PM	PM	PM	PM	PM	PM	E	J	J	J	J	J	PM	PM	PM	PM	PM	
		PM	PM	PM	PM	PM	PM	PM	PM	PM	PM	PM	PM	PM	PM	PM	K	K	K	K	K	K	PM	PM	PM	PM	PM	
		PM	PM	PM	PM	PM	PM	PM	PM	PM	PM	PM	PM	PM	PM	PM	N	N	N	N	N	N	PM	PM	PM	PM	PM	
		16P + 24S + 2P + 3ACP																										

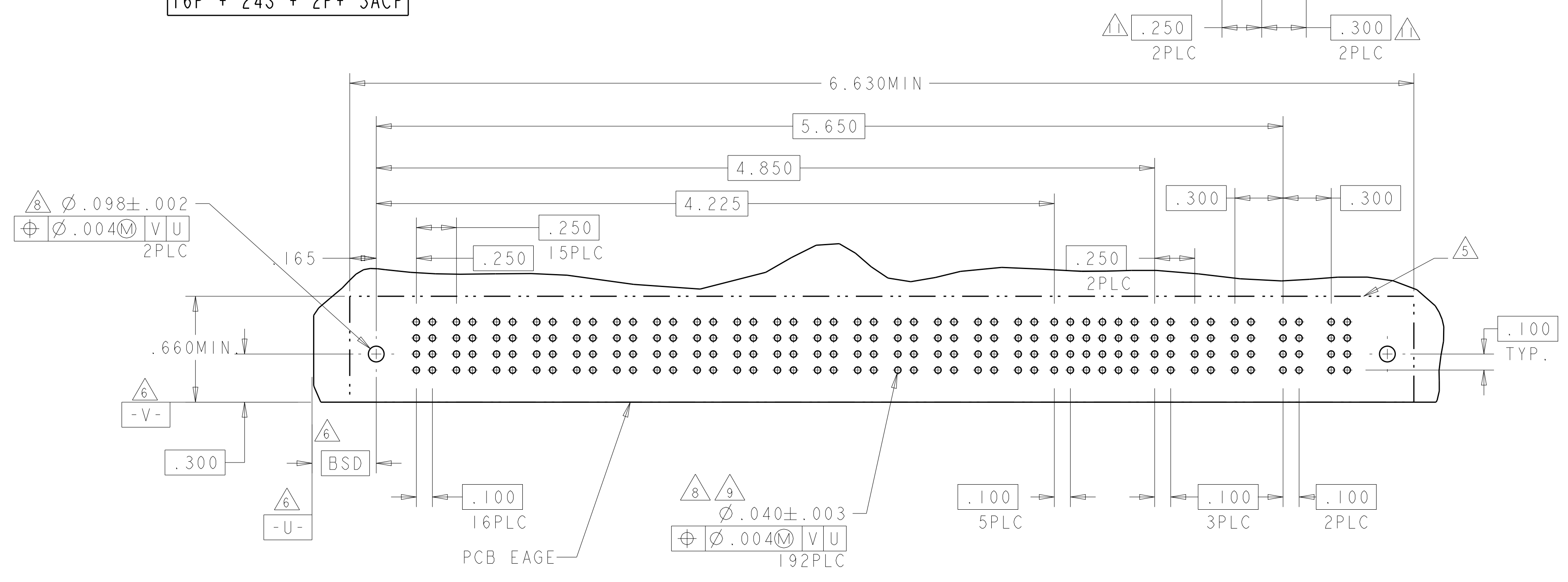

PART NUMBER	ROWS	POWER			SIGNAL						POWER		
		P1	P2	P3	1	2	3	4	5	6	P4	P5	P6
7-6450130-5	D C B A	PM					J	J	J	J	PM	PM	PM
		PM	PM				K	K	K	K	PM	PM	PM
		PM	PM				N	N	N	N	PM	PM	PM
		3P + 24S + 3P			NO CONTACTS LOADED								

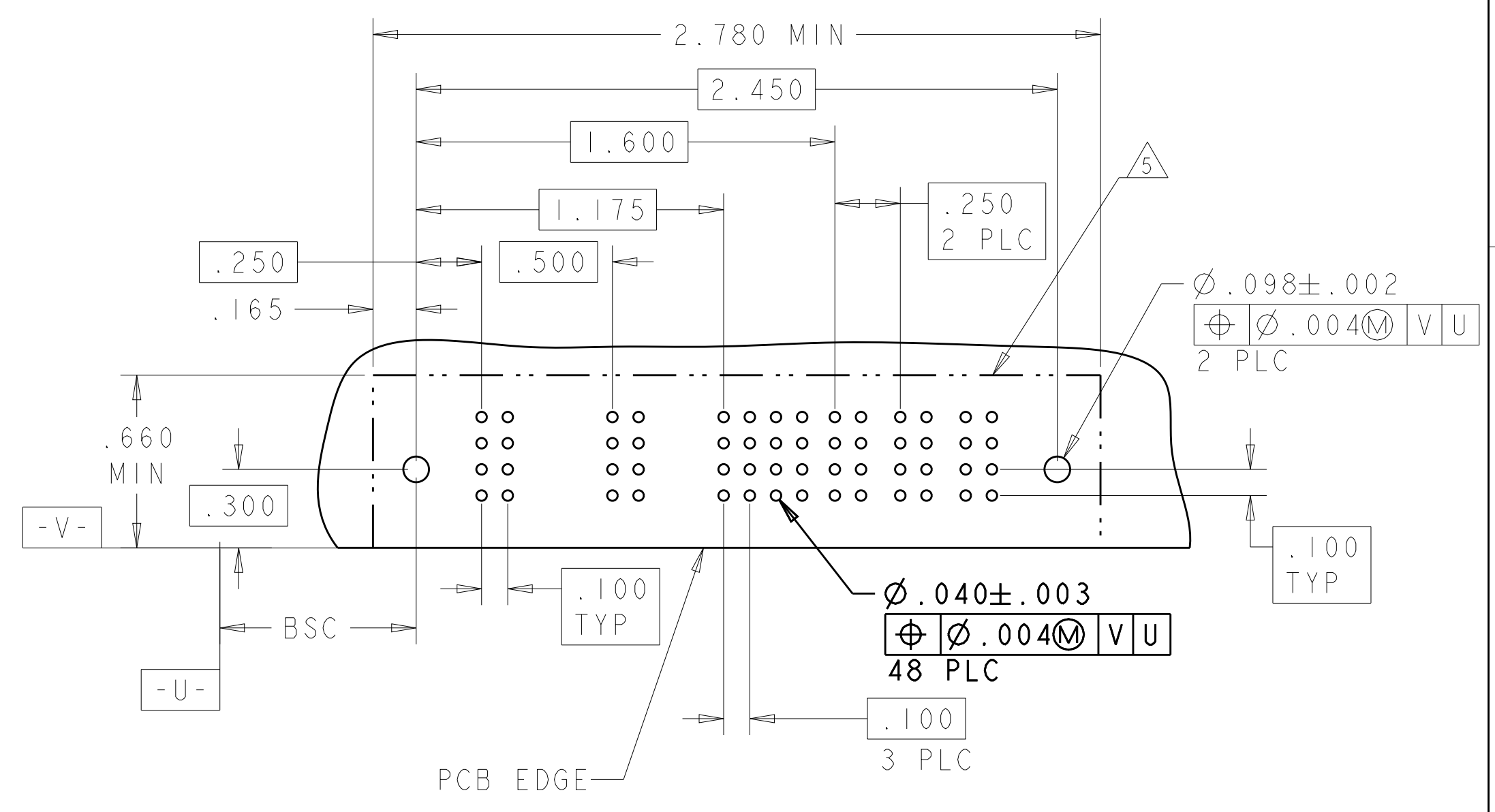

PART NUMBER	ROWS	POWER						SIGNAL															POWER						
		P1	P2	P3	P4	P5	P6	1	2	3	4	5	6	7	8	9	10	11	12	13	14	15	P7	P8	P9	P10	P11	P12	
7-6450130-7	D C B A	PM	PM	PM	PM	PM	PM	J	J	J	J	J	J	J	J	J	J	J	J	J	J	J	J	PM	PM	PM	PM	PM	PM
		PM	PM	PM	PM	PM	PM	K	K	K	K	K	K	K	K	K	K	K	K	K	K	K	K	PM	PM	PM	PM	PM	PM
		PM	PM	PM	PM	PM	PM	N	N	N	N	N	N	N	N	N	N	N	N	N	N	N	N	N	PM	PM	PM	PM	PM
		6P + 60S + 6P																											

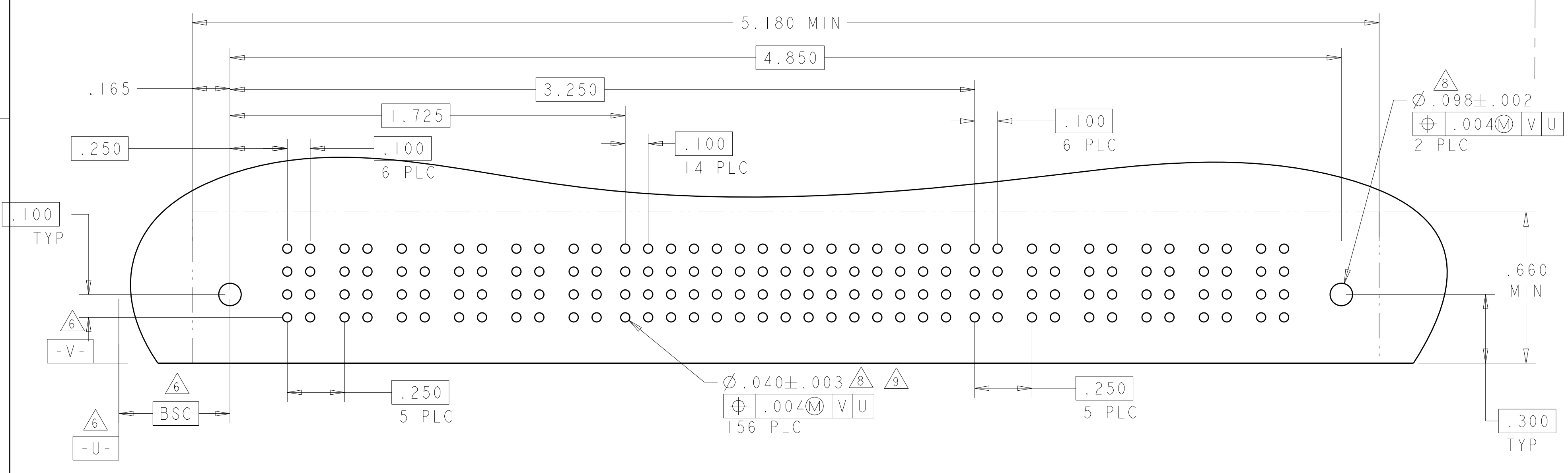

PART NUMBER	ROWS	POWER			SIGNAL						POWER		
		P1	P2	P3	1	2	3	4	5	6	P4	P5	P6
7-6450130-8	D C B A	PM	PM	PM	J	J	J	J	J	E	PM	PM	PM
		PM	PM	PM	K	K	K	K	K	K	PM	PM	PM
		PM	PM	PM	N	N	N	N	N	N	PM	PM	PM
		3P + 24S + 3P											

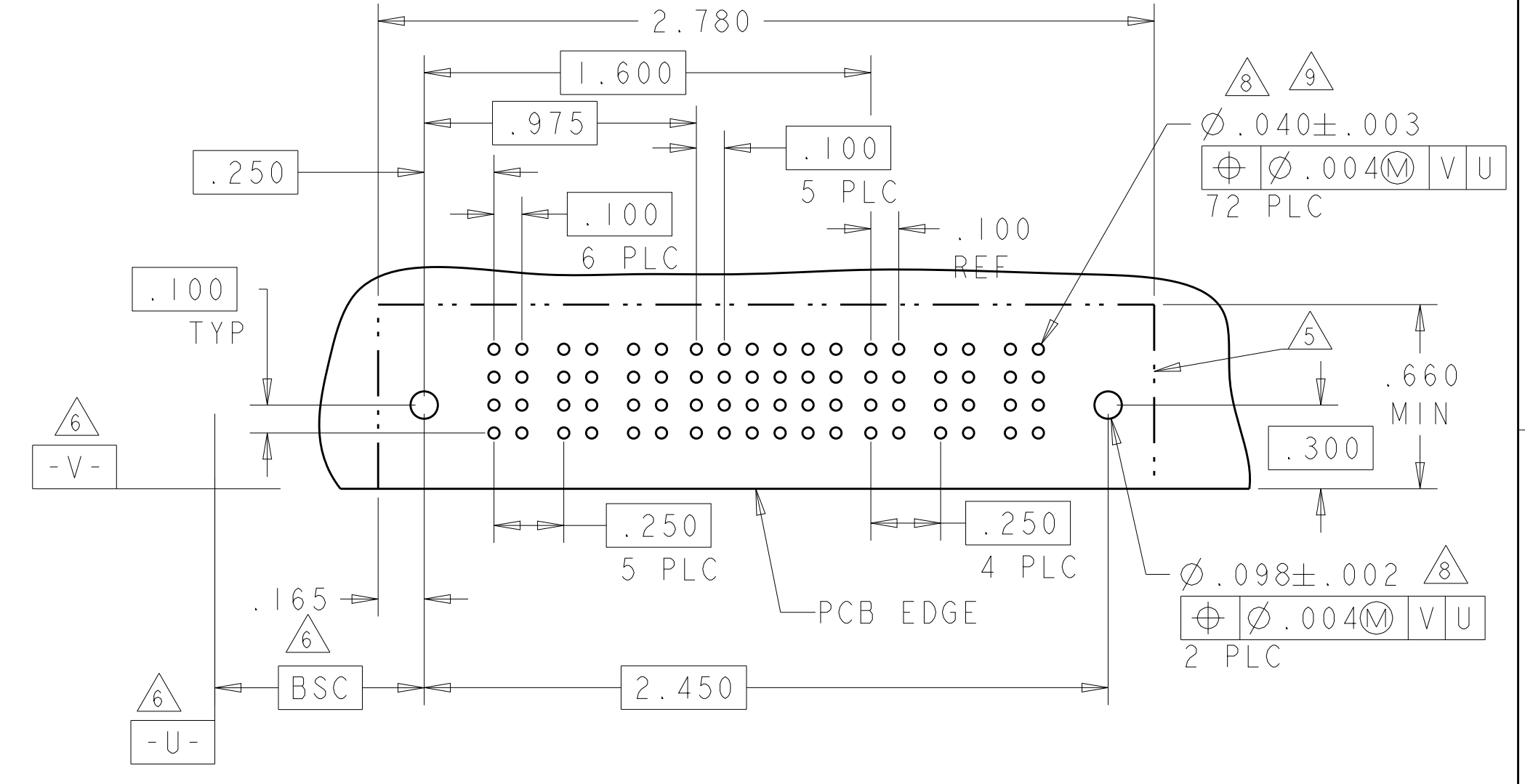

THIS DRAWING IS A CONTROLLED DOCUMENT. DWG: R.GRZYBOWSKI 14FEB2005, CHK: M.PERCHERKE 14FEB2005, APVD: M.PERCHERKE 14FEB2005

STE TE Connectivity

RIGHT ANGLE HEADER ASSEMBLY W/GUIDES MULTI-BEAM XL

Customer Drawing SCALE: 4:1 SHEET 12 OF 28 REV: M2

PART NUMBER	ROWS	POWER					SIGNAL					POWER	
		P1	P2	P3	P4	P5	1	2	3	4	5	P6	P7
7-6450130-9	D C B A	PM	PM	PM	PM	PM	J	J	J	J	J	PM	PM
							K	K	K	K	K		
							N	G	N	N	N		
							S	S	S	S	S		
5P + 20S + 2P													

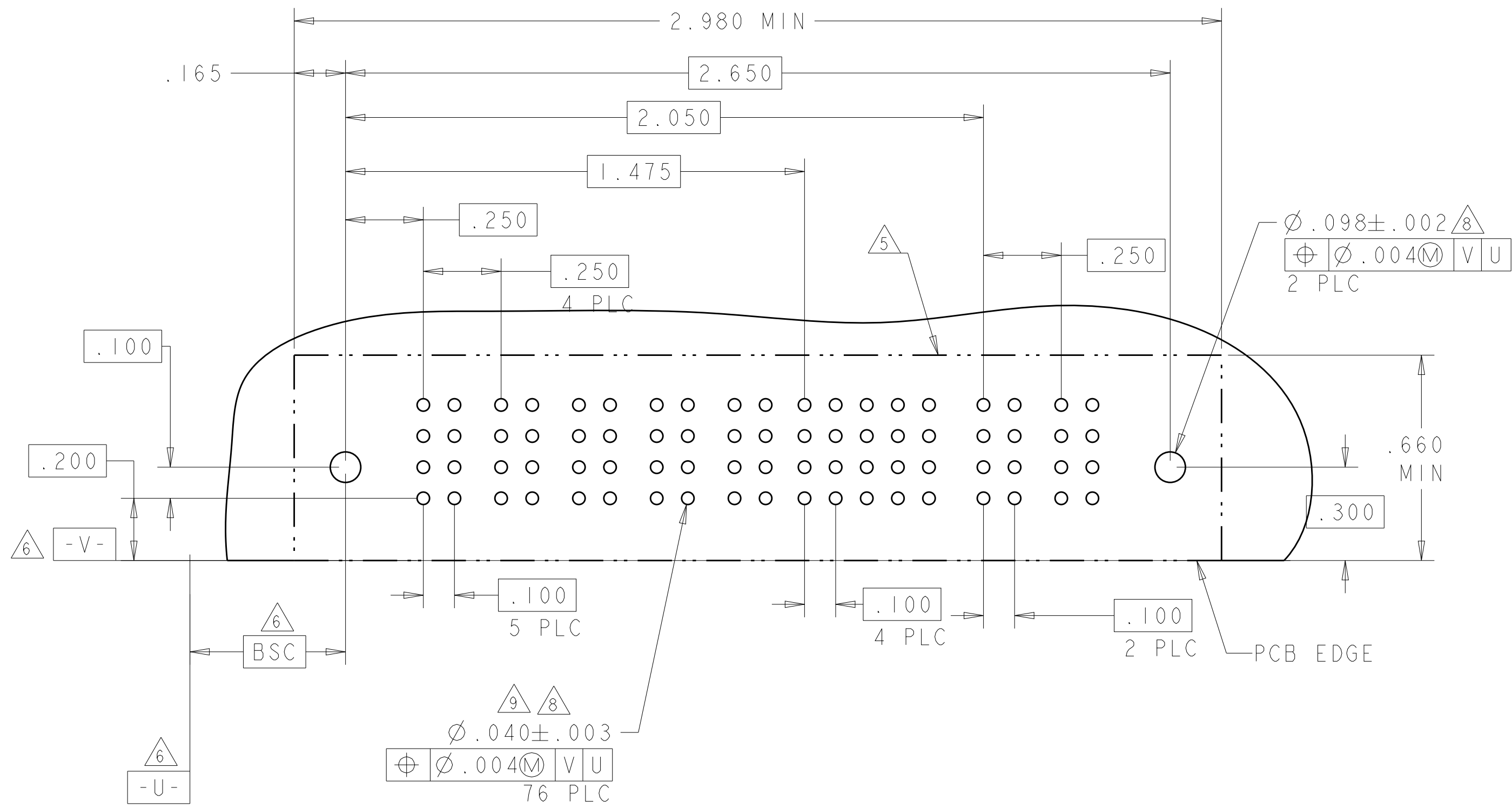

PART NUMBER	ROWS	POWER						SIGNAL					POWER	
		P1	P2	P3	P4	P5	P6	1	2	3	4	5	P7	P8
8-6450130-0	D C B A	PM	PM	PM	PM	PM	PM	J	J	J	J	J	PM	PM
								K	K	K	K	K		
								N	G	N	N	N		
								S	S	S	S	S		
6P + 20S + 2P														

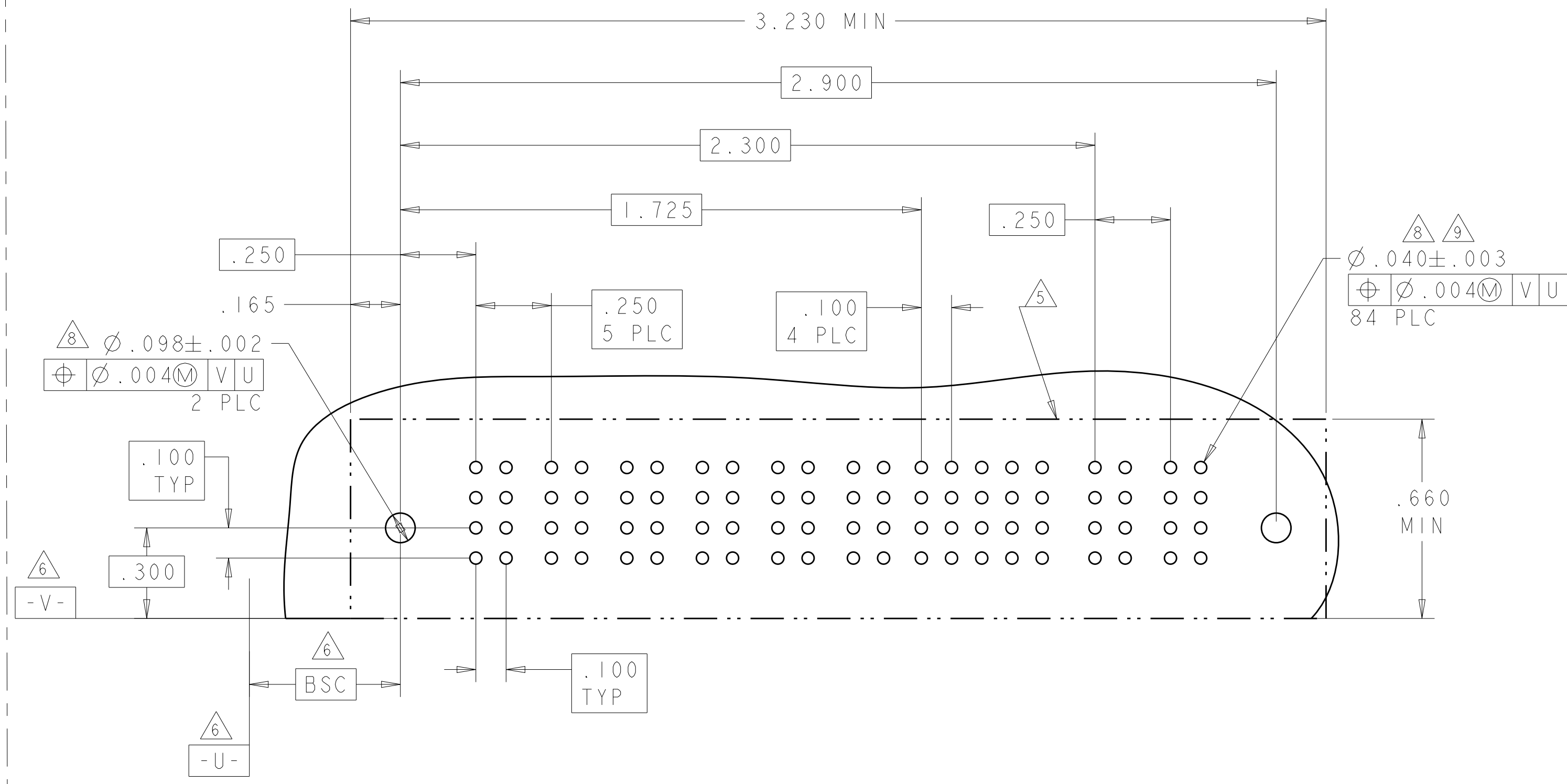

LOC	DIST	REV	DATE	APPV
ES	00			

REV	DATE	APPV	DESCRIPTION
-	-	-	SEE SHEET 1

PART NUMBER	ROWS	POWER			SIGNAL						POWER				
		P1	P2	P3	1	2	3	4	5	6	P4	P5	P6	P7	P8
7-6450130-6	D C B A	PM	PM	PM	J	J	J				PM	PM	PM	PM	PM
					K	K	K								
					N	N	N								
					S	S	S								
3ACP + 24S + 5P															

NO CONTACTS LOADER

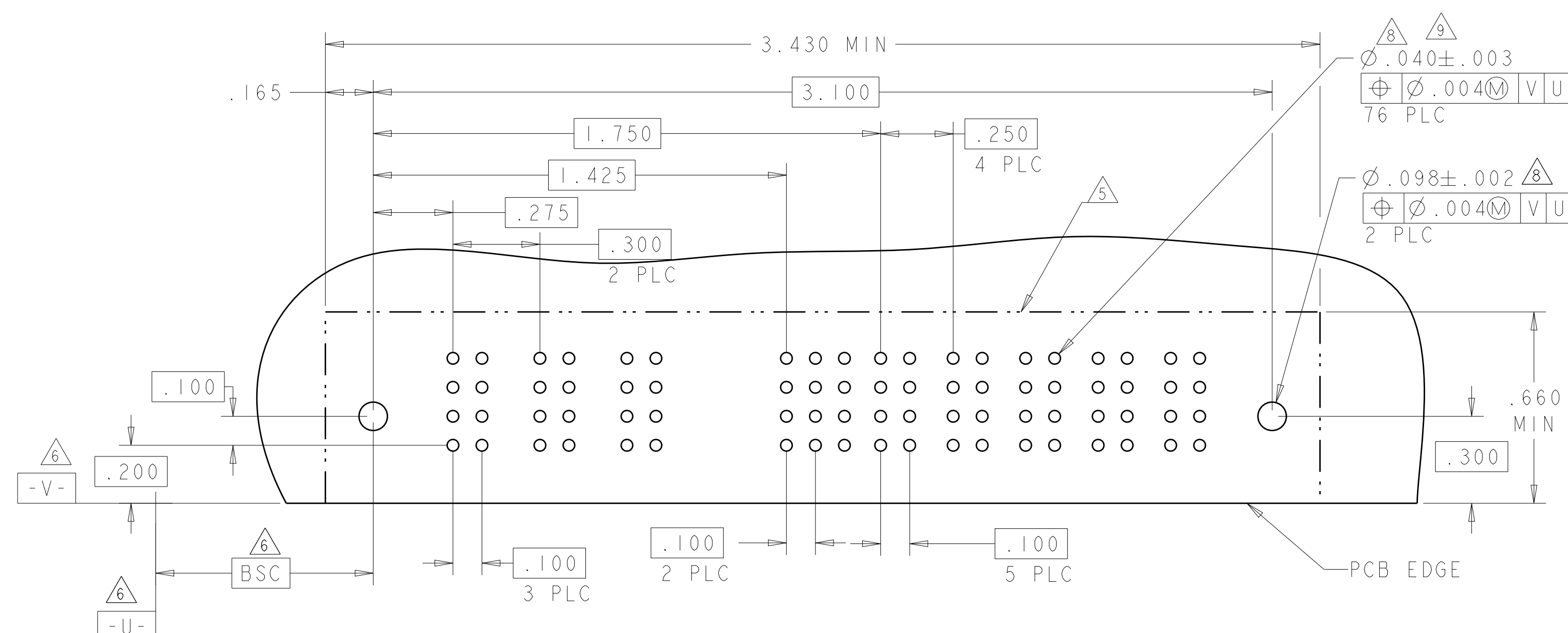

PART NUMBER	ROWS	POWER				SIGNAL						POWER		
		P1	P2	P3	P4	1	2	3	4	5	6	P5	P6	P7
8-6450130-2	D C B A	PM	PM	PM	PM	J	J	J	J	J	J	PM	PM	PM
						K	K	K	K	K	K			
						N	N	N	N	N	N			
						S	S	S	S	S	H			
4P + 24S + 3ACP														

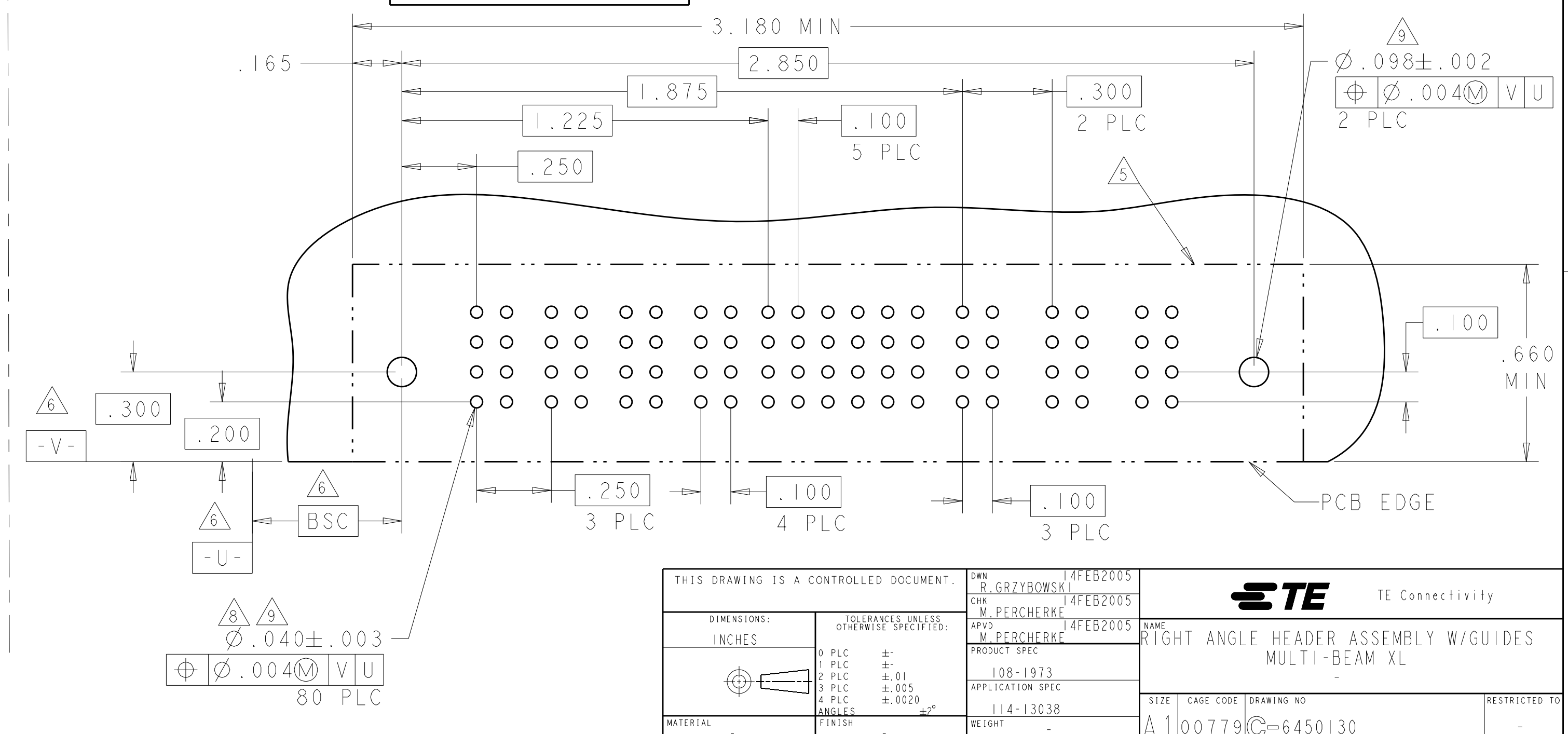

THIS DRAWING IS A CONTROLLED DOCUMENT.

<p>DIMENSIONS:</p> <p>INCHES</p>	<p>TOLERANCES UNLESS OTHERWISE SPECIFIED:</p> <p>0 PLC ±.01</p> <p>1 PLC ±.01</p> <p>2 PLC ±.01</p> <p>3 PLC ±.01</p> <p>4 PLC ±.005</p> <p>5 PLC ±.005</p> <p>6 PLC ±.002</p> <p>ANGLES ±.020</p>	<p>OWN: R. GRZYBOWSKI 14FEB2005</p> <p>CHK: M. PERCHERKE 14FEB2005</p> <p>APPV: M. PERCHERKE 14FEB2005</p> <p>PRODUCT SPEC</p> <p>108-1973</p> <p>APPLICATION SPEC</p> <p>114-13038</p> <p>WEIGHT</p> <p>Customer Drawing</p>	<p>NAME: RIGHT ANGLE HEADER ASSEMBLY W/GUIDES MULTI-BEAM XL</p> <p>SIZE: CAGE CODE DRAWING NO: A100779</p> <p>SCALE: 4:1</p> <p>SHEET 13 OF 28</p> <p>REV: M2</p>
----------------------------------	--	---	---

STE TE Connectivity

LOC	DIST	REVISIONS			
P	LTN	DESCRIPTION	DATE	DMN	APVD
ES	00	SEE SHEET 1			

PART NUMBER	ROWS	POWER			SIGNAL					POWER				
		P1	P2	P3	1	2	3	4	5	P4	P5	P6	P7	P8
8-6450130-4	D C B A	PM	PM	PM	J	J	J		J	PM	PM	PM	PM	
					K	K	K		K					
					N	N	N		N					
					S	S	S		H					
3P + 20S + 5P														

NO CONTACTS LOADED

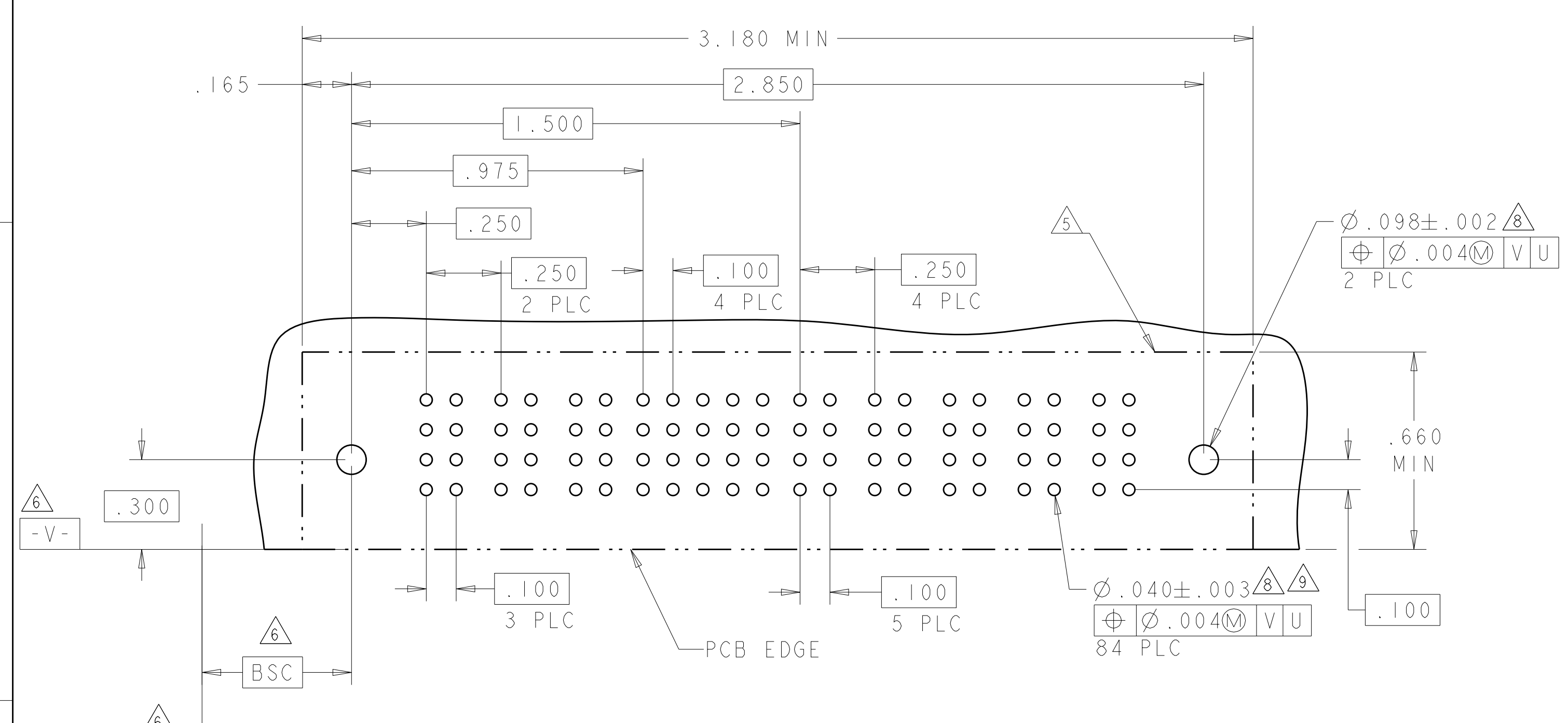

PART NUMBER	ROWS	POWER		SIGNAL				POWER	
		P1	P2	1	2	3	4	P2	P1
8-6450130-5	D C B A	PM	PM	J	E	J	E	PM	PM
				K	K	K	K		
				N	N	N	N		
				S	S	S	S		
IP + 16S + IP									

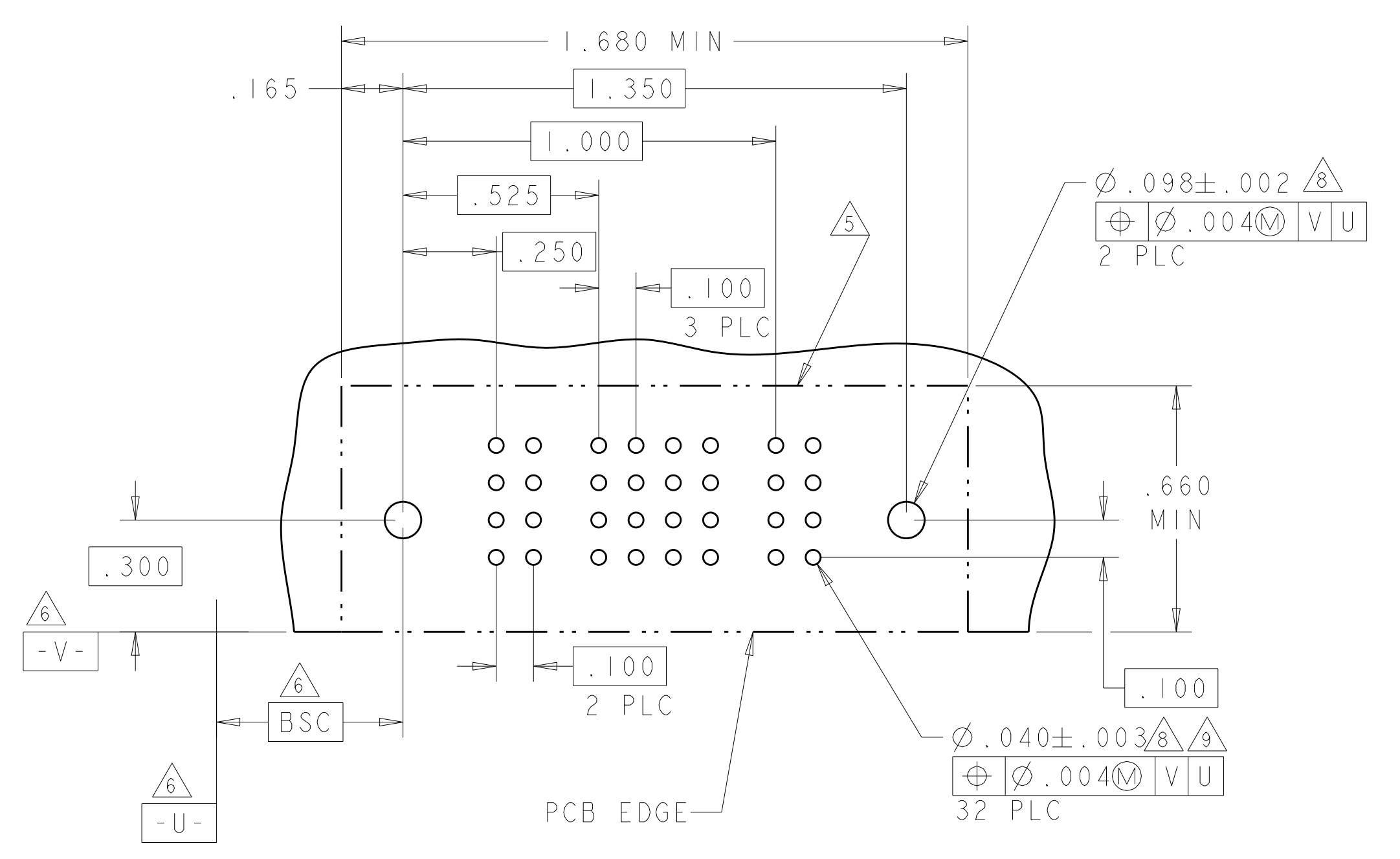

PART NUMBER	ROWS	POWER			SIGNAL						POWER	
		P1	P2	P3	1	2	3	4	5	6	P4	P5
5-6450130-1	D C B A	PM	PM	PM	J	E	J	J	J	J	PM	PM
					K	K	K	K	K			
					N	N	G	N	N			
					S	S	S	S	S			
3ACP + 24S + 2P												

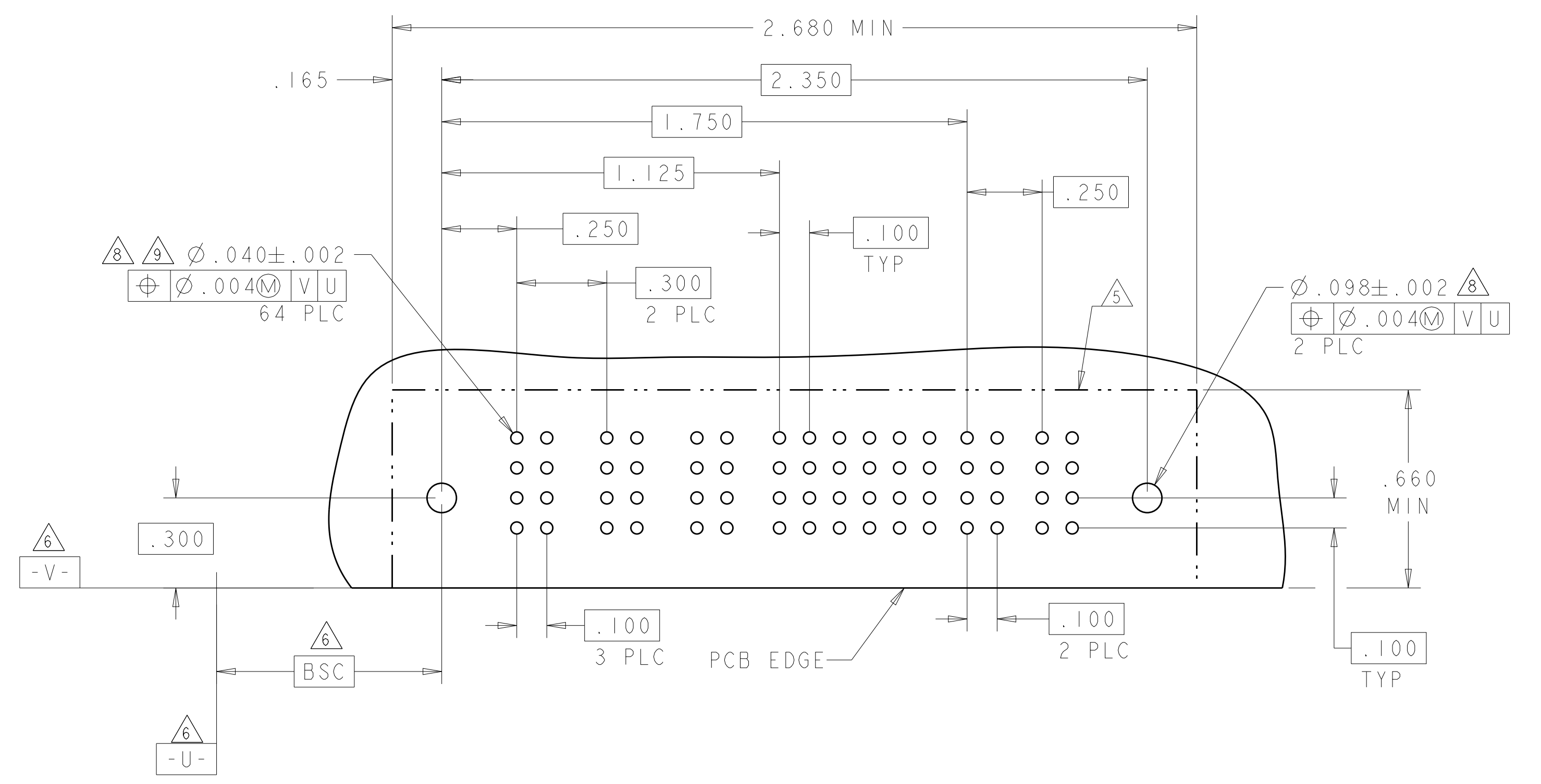

THIS DRAWING IS A CONTROLLED DOCUMENT.

DIMENSIONS:	TOLERANCES UNLESS OTHERWISE SPECIFIED:	DMN: R.GRZYBOWSKI 14FEB2005	CHK: M.PERCHEKKE 14FEB2005	APVD: M.PERCHEKKE 14FEB2005	NAME: RIGHT ANGLE HEADER ASSEMBLY W/GUIDES MULTI-BEAM XL
INCHES	0 PLC ±.01 1 PLC ±.01 2 PLC ±.01 3 PLC ±.005 4 PLC ±.002	PRODUCT SPEC: 108-1973	APPLICATION SPEC: 114-13038	WEIGHT: -	SIZE: A100779
MATERIAL:	FINISH:	RESTRICTED TO:	SCALE: 4:1	SHEET: 14 OF 28	REV: M2

Customer Drawing

LOC	DIST	REVISIONS			
P	LTN	DESCRIPTION	DATE	DMN	APVD
ES	00	SEE SHEET 1			

PART NUMBER	ROWS	POWER		SIGNAL			POWER					
		P1	P2	1	2	3	P3	P4	P5	P6	P7	
9-6450130-2	D	PM	PM	J	J	J	PM	PM	PM	PM	PM	HD
	C			K	K	K						
	B			N	N	N						
	A			S	S	S						
2P + 12S + 5P												

(K2)

PART NUMBER	ROWS	POWER				SIGNAL							POWER				
		P1	P2	P3	P4	1	2	3	4	5	6	7	P5	P6	P7	P8	
2-6450130-4	D	PA	PA	PA	PA	A4	A4	A4	A4	A4	A4	A4	PA	PA	PA	PA	HD
	C					A3	A3	A3	A3	A3	A3						
	B					A2	A2	A2	A2	A2	A2						
	A					A1	A1	A1	A1	A1	A1						
4HDP + 28S + 4HDP																	

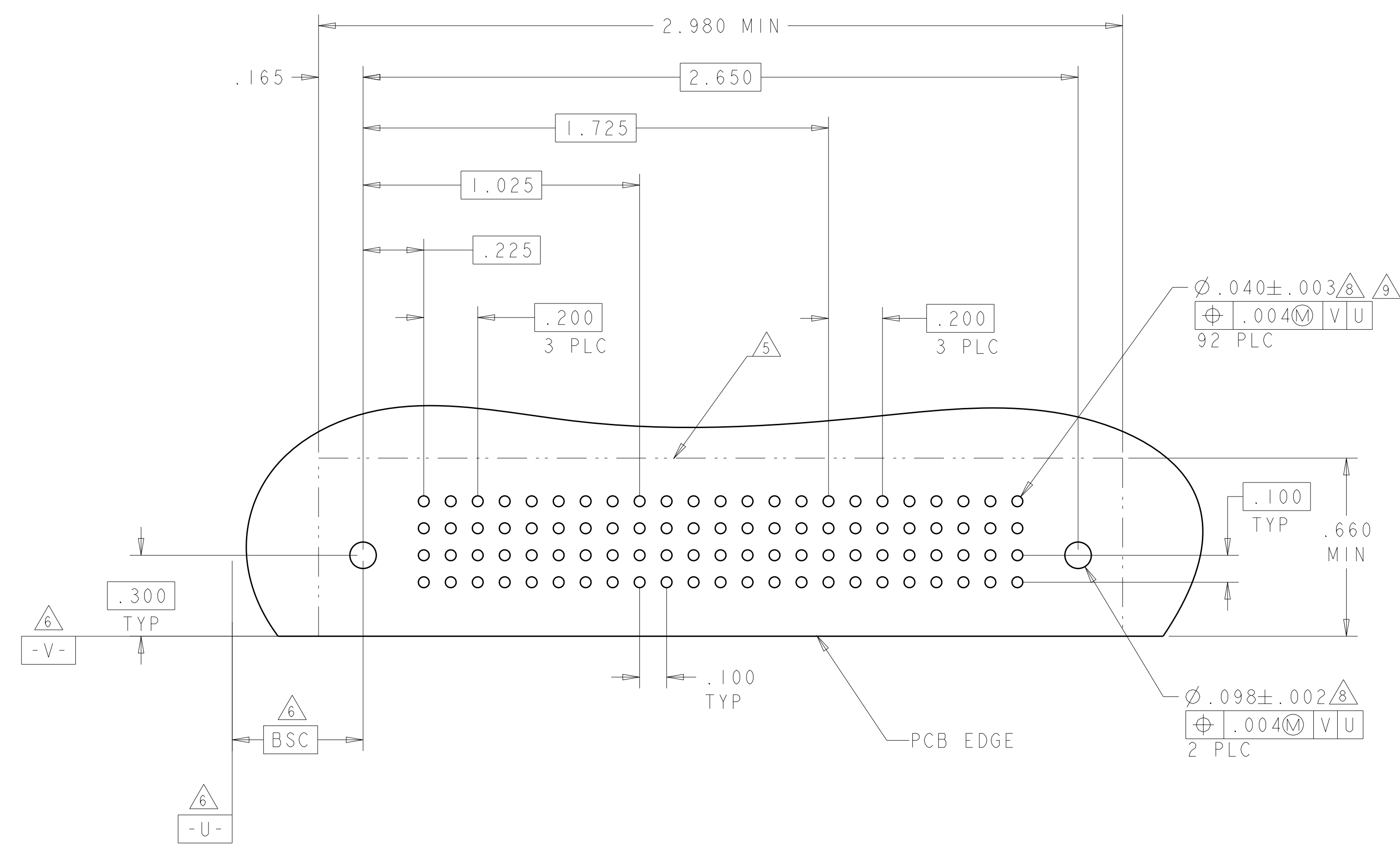
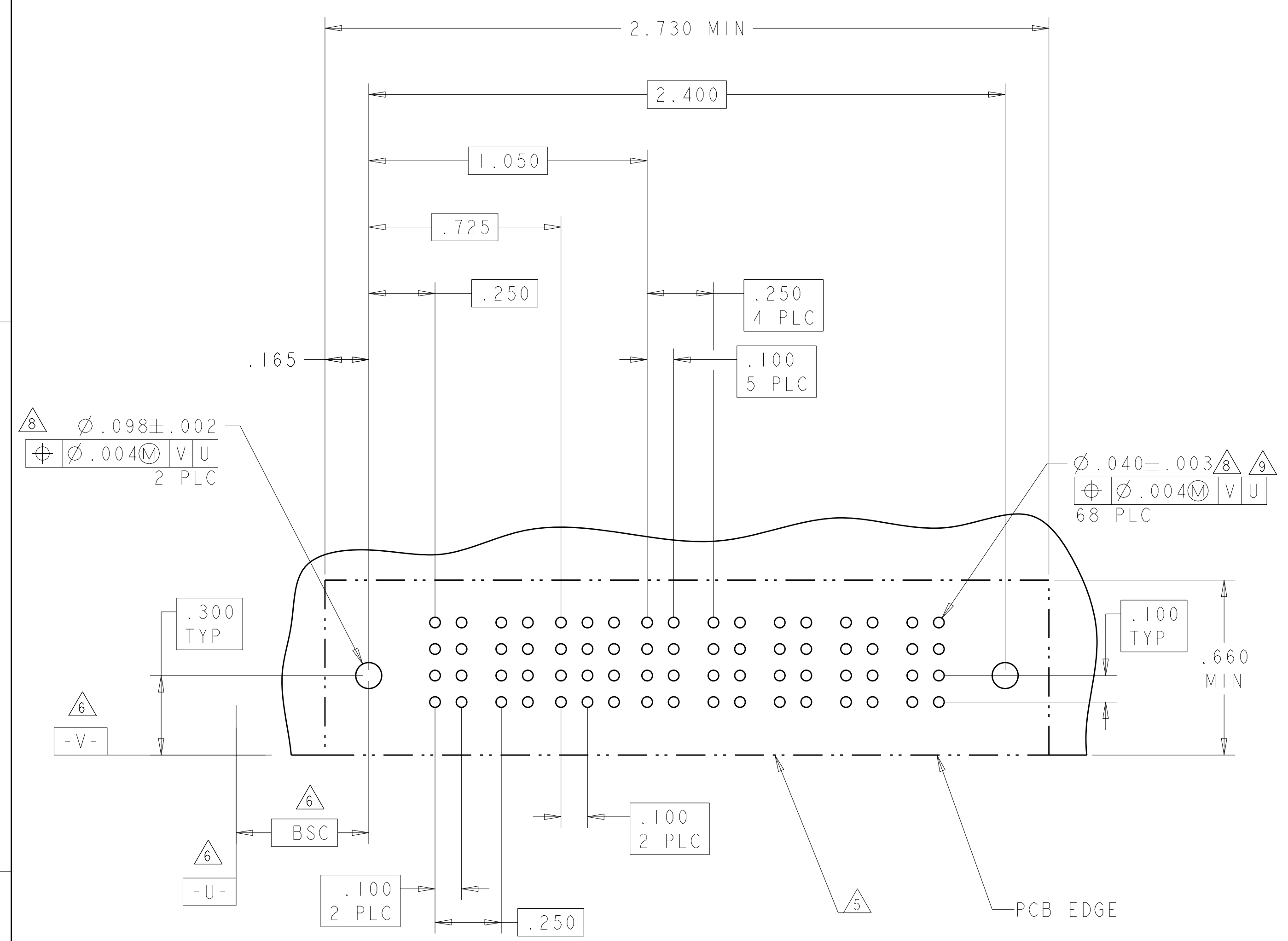

THIS DRAWING IS A CONTROLLED DOCUMENT.

DIMENSIONS:	TOLERANCES UNLESS OTHERWISE SPECIFIED:	DMN: R. GRZYBOWSKI 14FEB2005	CHK: M. PERCHERKE 14FEB2005	APVD: M. PERCHERKE 14FEB2005
INCHES	0 PLC ±.01 2 PLC ±.01 3 PLC ±.005 4 PLC ±.0020 ANGLES ±.7°	PRODUCT SPEC: 108-1973	APPLICATION SPEC: 114-13038	WEIGHT: -
MATERIAL: -	FINISH: -	SIZE: A1	CAGE CODE: 6450130	DRAWING NO: 100779
		Customer Drawing		SCALE: 4:1
		SHEET 18 OF 28		REV: M2

STE TE Connectivity

RIGHT ANGLE HEADER ASSEMBLY W/GUIDES MULTI-BEAM XL

LOC	DIST	REVISIONS			
P	LTN	DESCRIPTION	DATE	OWN	APVD
-	-	SEE SHEET 1	-	-	-

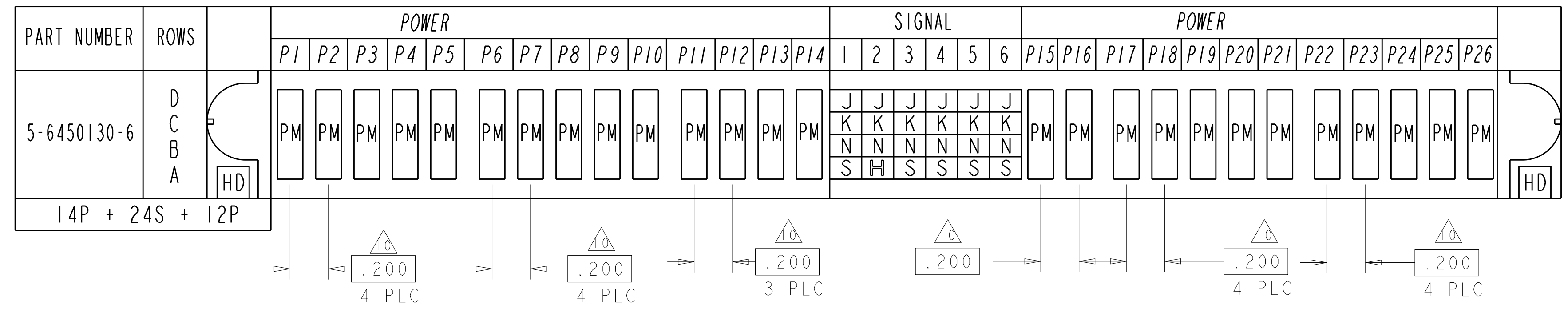

L2

L6

THIS DRAWING IS A CONTROLLED DOCUMENT.

DIMENSIONS: INCHES	TOLERANCES UNLESS OTHERWISE SPECIFIED: 0 PLC ±. 1 PLC ±.01 2 PLC ±.01 3 PLC ±.005 4 PLC ±.0020 ANGLES ±.7°	OWN: R. GRZYBOWSKI 14FEB2005 CHK: M. PERCHERKE 14FEB2005 APVD: M. PERCHERKE 14FEB2005	NAME: RIGHT ANGLE HEADER ASSEMBLY W/GUIDES MULTI-BEAM XL
MATERIAL: -	FINISH: -	PRODUCT SPEC: 108-1973 APPLICATION SPEC: 114-13038 WEIGHT: -	SIZE: A1 CAGE CODE: 00779 DRAWING NO: C=6450130
Customer Drawing		SCALE: 4:1	SHEET 21 OF 28 REV: M2

4805 (3/11)

LOC	DIST	REVISIONS					
		P	LTN	DESCRIPTION	DATE	DWN	APVD
ES	00	-	-	SEE SHEET 1	-	-	-

PART NUMBER	ROWS	POWER		SIGNAL						POWER		
		P1	P2	1	2	3	4	5	6	P3	P4	P5
9-6450130-5	D	PM	PM	J	J	E	J	J	J	PM	PM	PM
	C			K	K	K	K	K				
	B			N	N	G	N	N	N			
	A			S	S	S	S	S	S			

2P + 24S + 3ACP

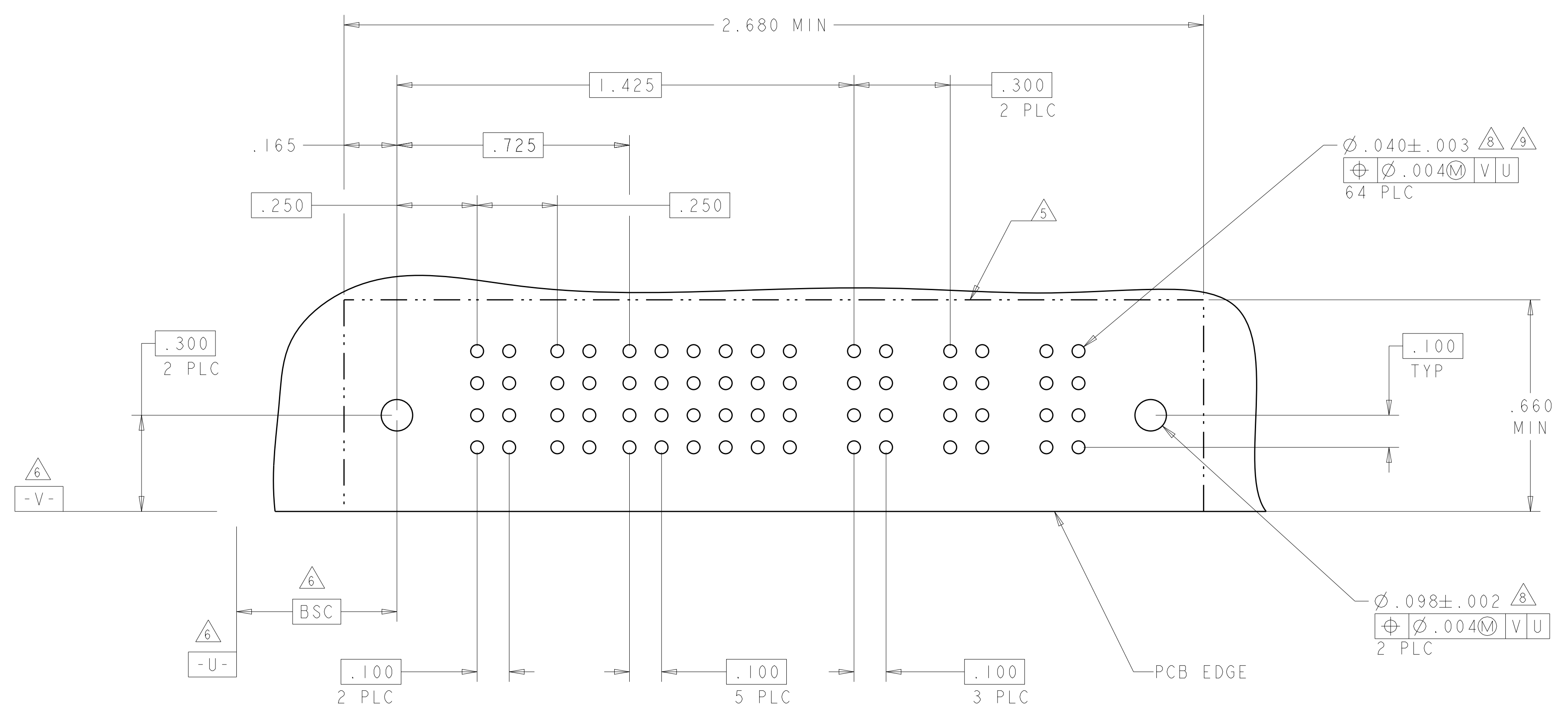

THIS DRAWING IS A CONTROLLED DOCUMENT.		DWN: R. GRZYBOWSKI 14FEB2005	 TE Connectivity
DIMENSIONS: INCHES		CHK: M. PERCHERKE 14FEB2005	
TOLERANCES UNLESS OTHERWISE SPECIFIED:		APVD: M. PERCHERKE 14FEB2005	NAME: RIGHT ANGLE HEADER ASSEMBLY W/GUIDES MULTI-BEAM XL
0 PLC ±	1 PLC ±.01	PRODUCT SPEC	SIZE: 108-1973
2 PLC ±.01	3 PLC ±.005	APPLICATION SPEC	RESTRICTED TO
4 PLC ±.0020	ANGLES ±.2°	114-13038	SCALE: 4:1 SHEET 22 OF 28 REV: M2
MATERIAL: -	FINISH: -	WEIGHT: -	Customer Drawing

LOC	DIST	REV	DATE	BY	APPV
ES	00				
REVISIONS			DESCRIPTION	DATE	BY
			SEE SHEET 1		

PART NUMBER	ROWS	POWER		SIGNAL												POWER			
		P1	P2	1	2	3	4	5	6	7	8	9	10	11	12	P3	P4		
6-6450130-9	D	PM	PM	E	J	J	J	J	J	J	J	J	J	J	J	E	PM	PM	
	C			K	K	K	K	K	K	K	K	K	K	K	K	K			
	B			N	N	N	N	N	N	N	N	N	N	N	N	N			N
	A			H	S	S	S	S	S	S	S	S	S	S	S	H			
2P + 48S + 2P																			

PART NUMBER	ROWS	POWER			SIGNAL						POWER				
		P1	P2	P3	1	2	3	4	5	6	P4	P5	P6		
9-6450130-7	D	PM	PM	PM			E	E					PM	PM	PM
	C						F	F							
	B						G	G							
	A						H	H							
3P + 24S + 3P															

(L5)

NO CONTACT LOADED

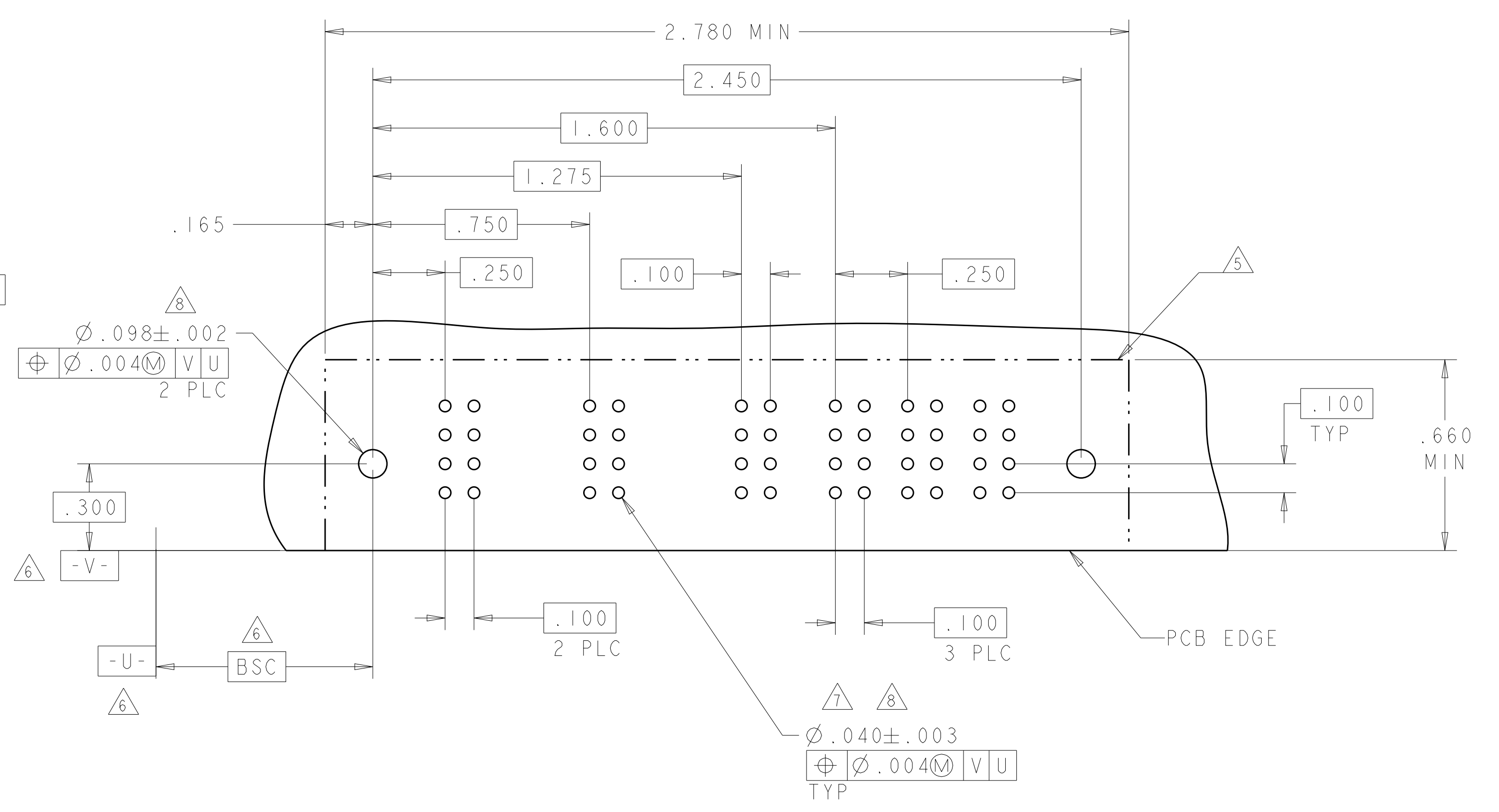
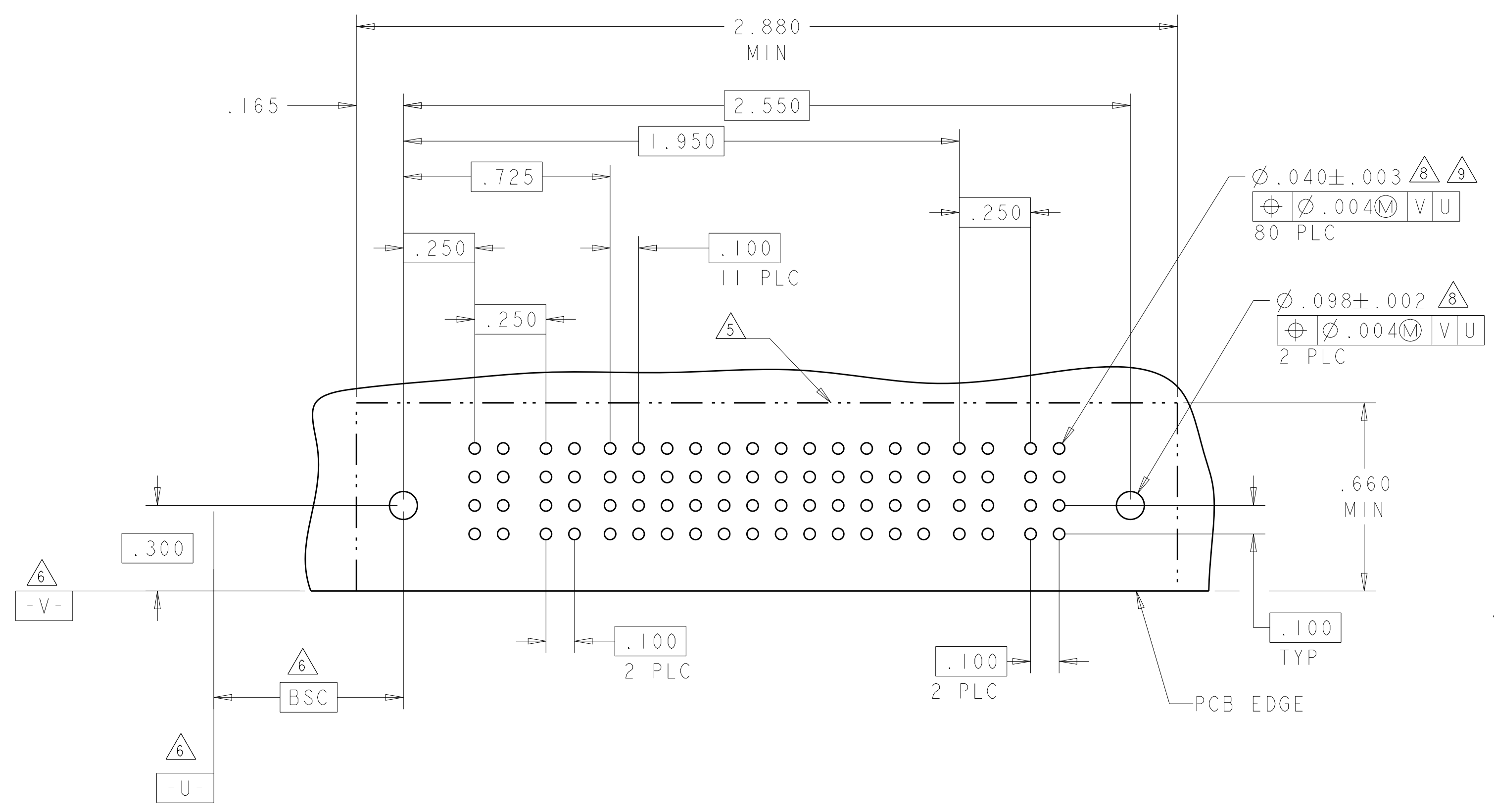

THIS DRAWING IS A CONTROLLED DOCUMENT.

OWN: R. GRZYBOWSKI 14FEB2005
 CHK: M. PERCHERKE 14FEB2005
 APVD: M. PERCHERKE 14FEB2005

STE TE Connectivity

NAME: RIGHT ANGLE HEADER ASSEMBLY W/GUIDES MULTI-BEAM XL

PRODUCT SPEC: 108-1973
 APPLICATION SPEC: 114-13038

SIZE: A1
 CAGE CODE: 6450130
 DRAWING NO: 100779

RESTRICTED TO: -

Customer Drawing SCALE: 4:1 SHEET: 24 OF 28 REV: M2

LOC	DIST	REVISIONS			
P	LTH	DESCRIPTION	DATE	DWN	APVD
-	-	SEE SHEET 1	-	-	-

PART NUMBER	ROWS	POWER		SIGNAL						POWER			
		P1	P2	1	2	3	4	5	6	P3	P4	P5	P6
9-6450130-8	D	PM	PM	E	J	J	J	J	E	PM	PM	PM	PM
	C			F	K	K	K	K	F				
	B			N	N	N	N	N	N				
	A			S	S	S	S	S	S				

2P + 24S + 4P

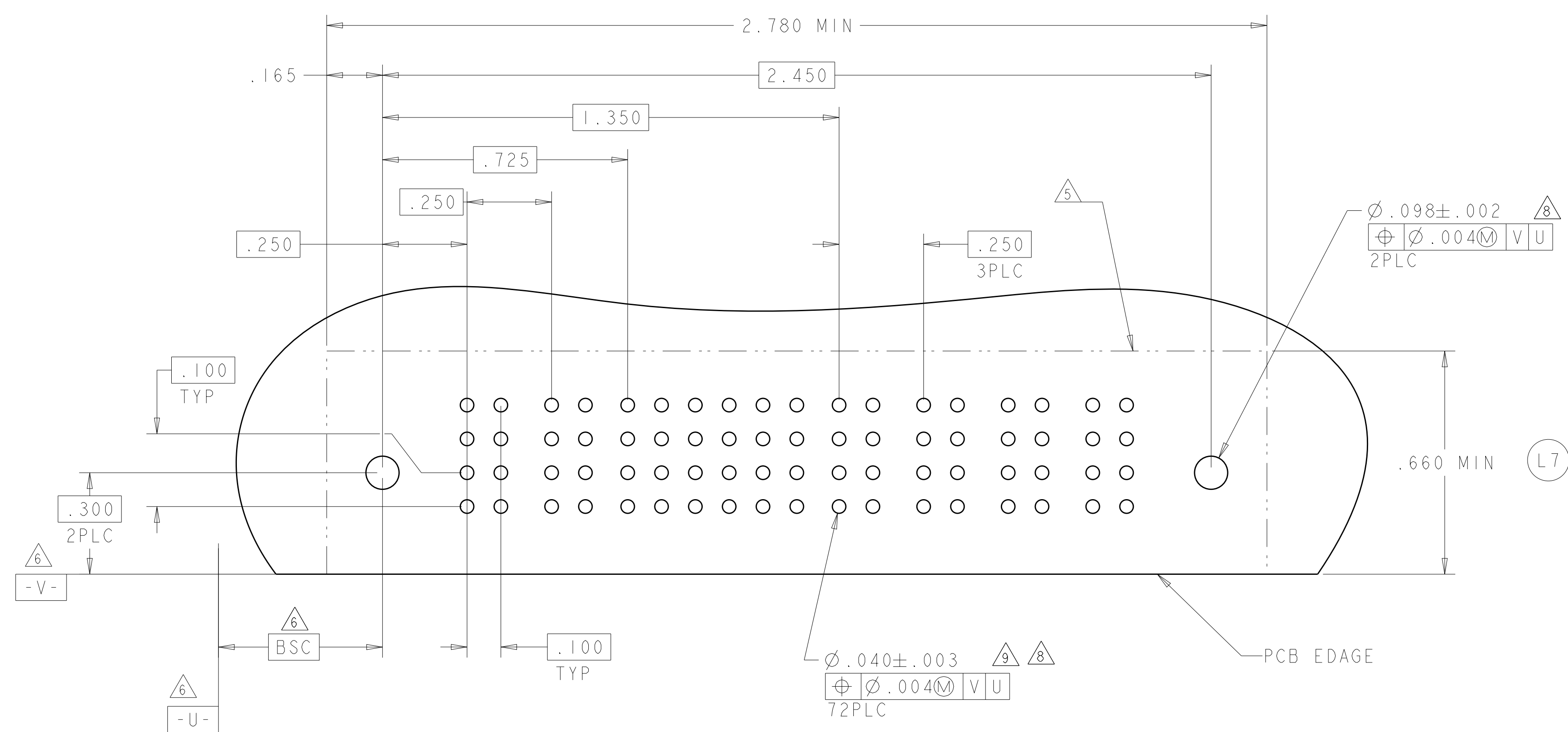

THIS DRAWING IS A CONTROLLED DOCUMENT.

DIMENSIONS: INCHES	TOLERANCES UNLESS OTHERWISE SPECIFIED:	DWN: R. GRZYBOWSKI 14FEB2005	CHK: M. PERCHERKE 14FEB2005	APVD: M. PERCHERKE 14FEB2005	NAME: RIGHT ANGLE HEADER ASSEMBLY W/GUIDES MULTI-BEAM XL
0 PLC ±.01	1 PLC ±.01	PRODUCT SPEC: 108-1973	APPLICATION SPEC: 114-13038	SIZE: A1	CAGE CODE: 6450130
2 PLC ±.01	3 PLC ±.005	WEIGHT: -	SCALE: 4:1	SHEET: 25	OF: 28
4 PLC ±.0020	ANGLES ±.2°	MATERIAL: -	FINISH: -	Customer Drawing	REV: M2

4805 (3/11)

LOC	DIST	REV	DATE	BY	APPV
ES	00				
		DESCRIPTION		DATE	BY
		SEE SHEET 1			

PART NUMBER	ROWS	POWER		SIGNAL								POWER			
		PI	P2	1	2	3	4	5	6	7	8	PI	P2		
9-6450130-9	D	PM	PM	J	J	J	J	J	J	J	J	J	J	J	
	C			K	K	K	F	K	K	K	K	K	K	K	
	B			N	N	N	N	N	N	N	N	N	N	N	N
	A			S	S	S	S	S	S	S	S	S	S	S	S
IP + 32S + IP		HD	HD									HD	HD		

(L8)

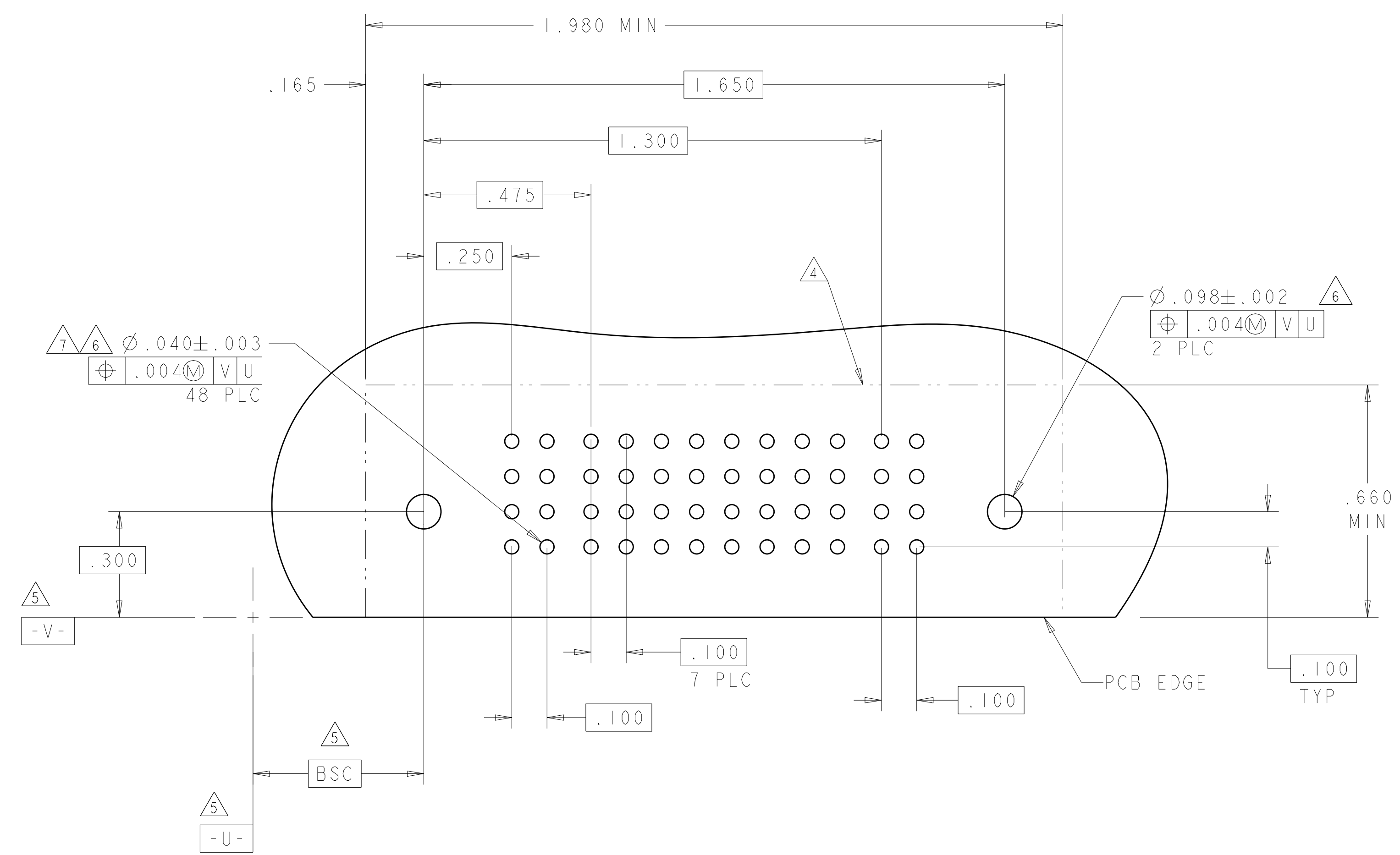

THIS DRAWING IS A CONTROLLED DOCUMENT.		OWN: R. GRZYBOWSKI 14FEB2005	TE Connectivity												
DIMENSIONS: INCHES		CHK: M. PERCHERKE 14FEB2005													
TOLERANCES UNLESS OTHERWISE SPECIFIED:		APVD: M. PERCHERKE 14FEB2005	NAME: RIGHT ANGLE HEADER ASSEMBLY W/GUIDES MULTI-BEAM XL												
<table border="1"> <tr><td>0 PLC</td><td>±</td></tr> <tr><td>1 PLC</td><td>±.01</td></tr> <tr><td>2 PLC</td><td>±.01</td></tr> <tr><td>3 PLC</td><td>±.005</td></tr> <tr><td>4 PLC</td><td>±.0020</td></tr> <tr><td>ANGLES</td><td>±.2°</td></tr> </table>		0 PLC	±	1 PLC	±.01	2 PLC	±.01	3 PLC	±.005	4 PLC	±.0020	ANGLES	±.2°	PRODUCT SPEC: 108-1973	SIZE: A1
0 PLC	±														
1 PLC	±.01														
2 PLC	±.01														
3 PLC	±.005														
4 PLC	±.0020														
ANGLES	±.2°														
MATERIAL: -		APPLICATION SPEC: 114-13038	CAGE CODE: C=6450130												
FINISH: -		WEIGHT: -	RESTRICTED TO: -												
Customer Drawing		SCALE: 4:1	SHEET 26 OF 28 REV: M2												

LOC		DIST		REVISONS			
P	LTN	DESCRIPTION	DATE	DMN	APVD		
-	-	SEE SHEET 1	-	-	-	-	-

(L9)

PART NUMBER	ROWS	POWER	SIGNAL		POWER
			P1	P2	
7-6450130-1	D	PM	J	J	PM
	C	PM	K	K	PM
	B	PM	N	N	PM
	A	HD	H	S	HD
3ACP + 8S + 2P					

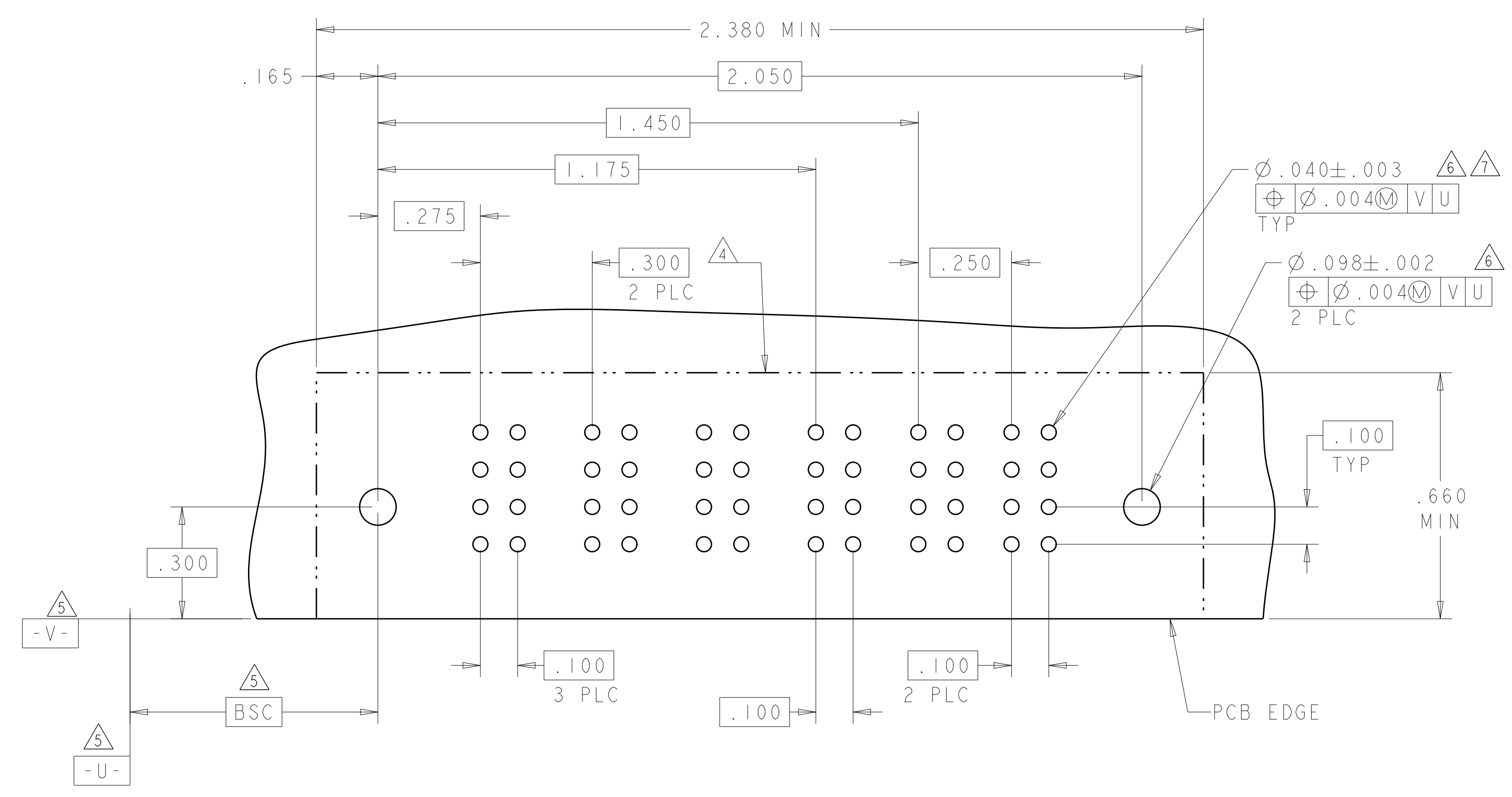

THIS DRAWING IS A CONTROLLED DOCUMENT.

DIMENSIONS: INCHES	TOLERANCES UNLESS OTHERWISE SPECIFIED:	0 PLC ± .010 1 PLC ± .010 2 PLC ± .010 3 PLC ± .005 4 PLC ± .0020	APVD: M. PERCHERKE	DATE: 14FEB2005	NAME: M. PERCHERKE	TE Connectivity
		ANGLES: ± 2°	PRODUCT SPEC: 108-1973	APPLICATION SPEC: 114-13038	SIZE: A1	RESTRICTED TO: -
MATERIAL: -	FINISH: -	WEIGHT: -	Customer Drawing		SCALE: 4:1	SHEET 27 OF 28

4805 (3/11)

LOC	DIST	REVISIONS			
P	LTN	DESCRIPTION	DATE	DMN	APVD
-	-	SEE SHEET 1	-	-	-

PART NUMBER	ROWS	POWER				SIGNAL						POWER		
		P1	P2	P3	P4	1	2	3	4	5	6	P5	P6	P7
5-6450130-3	D C B A	PM	PM	PM	PM	J	J	J	J	J	J	PM	PM	PM
						K	K	K	K	K	K			
						N	N	N	N	N	N			
						H	S	S	S	S	S			
4HDP + 24S + 3HDP														

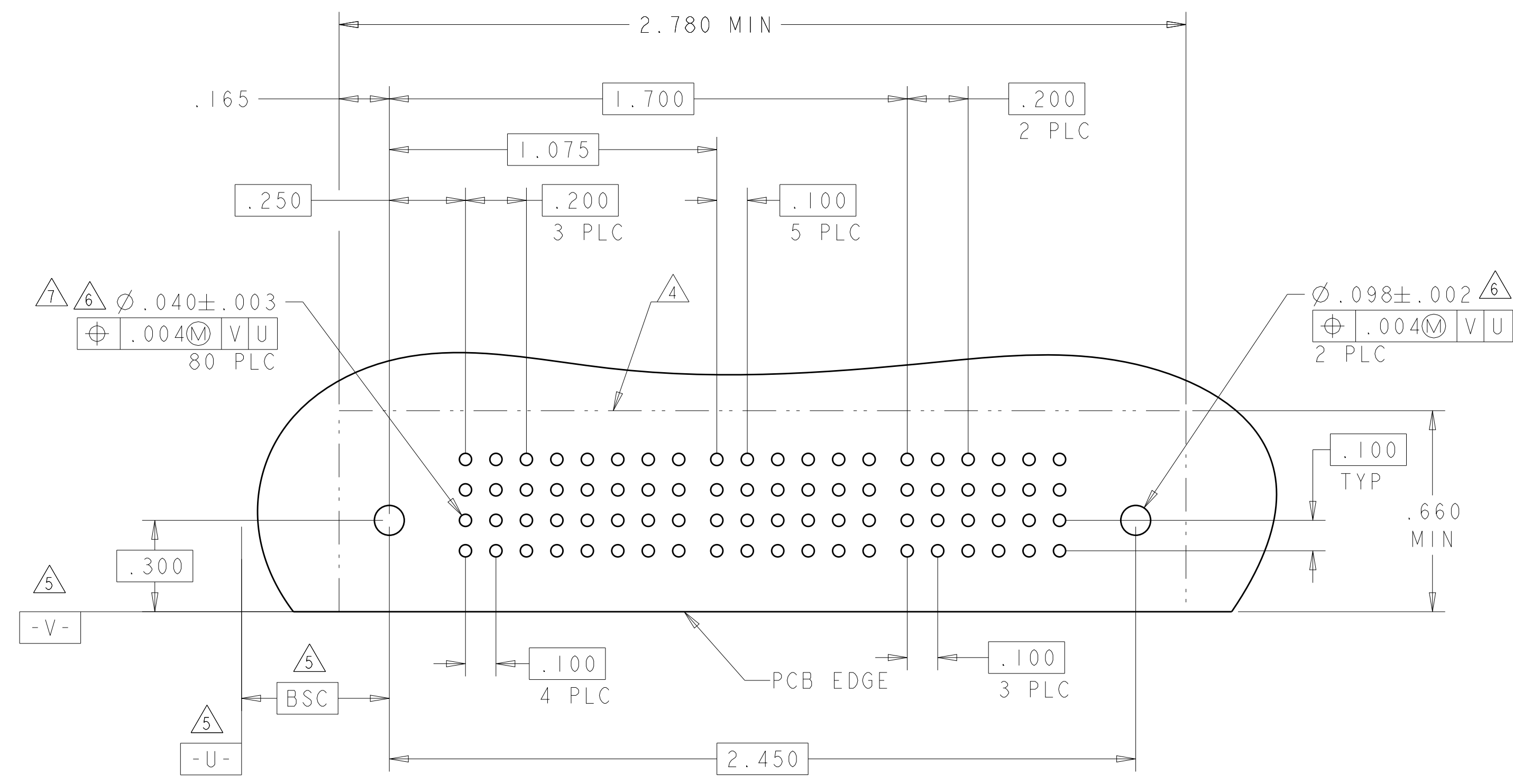

THIS DRAWING IS A CONTROLLED DOCUMENT.		DMN: R.GRZYBOWSKI 14FEB2005	TE Connectivity												
DIMENSIONS: INCHES		CHK: M.PERCHEKKE 14FEB2005													
TOLERANCES UNLESS OTHERWISE SPECIFIED:		APVD: M.PERCHEKKE 14FEB2005	NAME: RIGHT ANGLE HEADER ASSEMBLY W/GUIDES MULTI-BEAM XL												
<table border="1"> <tr><td>0 PLC</td><td>±</td></tr> <tr><td>1 PLC</td><td>±.01</td></tr> <tr><td>2 PLC</td><td>±.01</td></tr> <tr><td>3 PLC</td><td>±.005</td></tr> <tr><td>4 PLC</td><td>±.0020</td></tr> <tr><td>ANGLES</td><td>±.2°</td></tr> </table>		0 PLC	±	1 PLC	±.01	2 PLC	±.01	3 PLC	±.005	4 PLC	±.0020	ANGLES	±.2°	PRODUCT SPEC: 108-1973	SIZE: A
0 PLC	±														
1 PLC	±.01														
2 PLC	±.01														
3 PLC	±.005														
4 PLC	±.0020														
ANGLES	±.2°														
MATERIAL: -		APPLICATION SPEC: 114-13038	CAGE CODE: C=6450130												
FINISH: -		WEIGHT: -	RESTRICTED TO: -												
Customer Drawing		SCALE: 4:1	SHEET 28 OF 28 REV: M2												



Компания «ЭлектроПласт» предлагает заключение долгосрочных отношений при поставках импортных электронных компонентов на взаимовыгодных условиях!

Наши преимущества:

- Оперативные поставки широкого спектра электронных компонентов отечественного и импортного производства напрямую от производителей и с крупнейших мировых складов;
- Поставка более 17-ти миллионов наименований электронных компонентов;
- Поставка сложных, дефицитных, либо снятых с производства позиций;
- Оперативные сроки поставки под заказ (от 5 рабочих дней);
- Экспресс доставка в любую точку России;
- Техническая поддержка проекта, помощь в подборе аналогов, поставка прототипов;
- Система менеджмента качества сертифицирована по Международному стандарту ISO 9001;
- Лицензия ФСБ на осуществление работ с использованием сведений, составляющих государственную тайну;
- Поставка специализированных компонентов (Xilinx, Altera, Analog Devices, Intersil, Interpoint, Microsemi, Aeroflex, Peregrine, Syfer, Eurofarad, Texas Instrument, Miteq, Cobham, E2V, MA-COM, Hittite, Mini-Circuits, General Dynamics и др.);

Помимо этого, одним из направлений компании «ЭлектроПласт» является направление «Источники питания». Мы предлагаем Вам помощь Конструкторского отдела:

- Подбор оптимального решения, техническое обоснование при выборе компонента;
- Подбор аналогов;
- Консультации по применению компонента;
- Поставка образцов и прототипов;
- Техническая поддержка проекта;
- Защита от снятия компонента с производства.



Как с нами связаться

Телефон: 8 (812) 309 58 32 (многоканальный)

Факс: 8 (812) 320-02-42

Электронная почта: org@eplast1.ru

Адрес: 198099, г. Санкт-Петербург, ул. Калинина, дом 2, корпус 4, литера А.