

FEATURES

True single-supply operation

- Output swings rail-to-rail
- Input voltage range extends below ground
- Single-supply capability from 5 V to 30 V
- Dual-supply capability from ± 2.5 V to ± 15 V

High load drive

- Capacitive load drive of 350 pF, $G = +1$
- Minimum output current of 15 mA

Excellent ac performance for low power

- 800 μ A maximum quiescent current per amplifier
- Unity-gain bandwidth: 1.8 MHz
- Slew rate of 3 V/ μ s

Good dc performance

- 800 μ V maximum input offset voltage
- 2 μ V/ $^{\circ}$ C typical offset voltage drift
- 25 pA maximum input bias current

Low noise

- 13 nV/ $\sqrt{\text{Hz}}$ @ 10 kHz
- No phase inversion

APPLICATIONS

- Battery-powered precision instrumentation
- Photodiode preamps
- Active filters
- 12-bit to 14-bit data acquisition systems
- Medical instrumentation
- Low power references and regulators

CONNECTION DIAGRAM

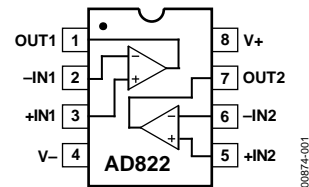

Figure 1. 8-Lead PDIP (N Suffix);
8-Lead MSOP (RM Suffix);
and 8-Lead SOIC_N (R Suffix)

GENERAL DESCRIPTION

The AD822 is a dual precision, low power FET input op amp that can operate from a single supply of 5 V to 30 V or dual supplies of ± 2.5 V to ± 15 V. It has true single-supply capability with an input voltage range extending below the negative rail, allowing the AD822 to accommodate input signals below ground in the single-supply mode. Output voltage swing extends to within 10 mV of each rail, providing the maximum output dynamic range.

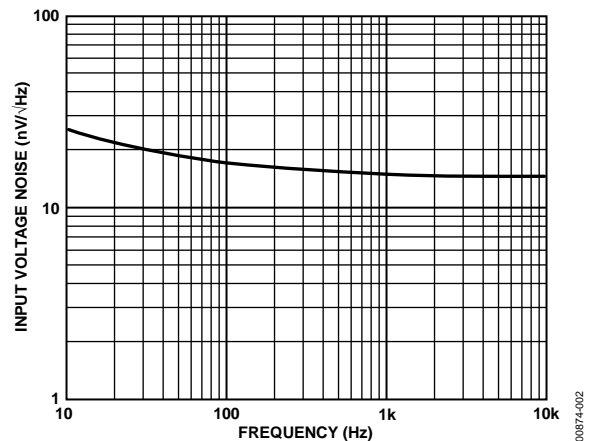

Figure 2. Input Voltage Noise vs. Frequency

Offset voltage of 800 μ V maximum, offset voltage drift of 2 μ V/ $^{\circ}$ C, input bias currents below 25 pA, and low input voltage noise provide dc precision with source impedances up to a gigaohm. The 1.8 MHz unity-gain bandwidth, -93 dB THD at 10 kHz, and 3 V/ μ s slew rate are provided with a low supply current of 800 μ A per amplifier.

Rev. I

Information furnished by Analog Devices is believed to be accurate and reliable. However, no responsibility is assumed by Analog Devices for its use, nor for any infringements of patents or other rights of third parties that may result from its use. Specifications subject to change without notice. No license is granted by implication or otherwise under any patent or patent rights of Analog Devices. Trademarks and registered trademarks are the property of their respective owners.

TABLE OF CONTENTS

Features	1
Applications.....	1
Connection Diagram	1
General Description	1
Revision History	2
Specifications.....	4
Absolute Maximum Ratings.....	10
Thermal Resistance	10
Maximum Power Dissipation	10
ESD Caution.....	10

REVISION HISTORY

1/10—Rev. H to Rev. I

Changes to Features Section and General Description Section .	1
Changes to Endnote 1, Table 1.....	5
Changes to Endnote 1, Table 2.....	7
Changes to Endnote 1, Table 3.....	9
Deleted Table 4; Renumbered Sequentially	10
Changes to Table 5.....	12
Updated Outline Dimensions	21
Changes to Ordering Guide	22
Deleted 3 V, Single-Supply Stereo Headphone Driver Section.	22
Deleted Figure 50; Renumbered Sequentially	22

8/08—Rev. G to Rev. H.

Changes to Features Section and General Description Section .	1
Changed V_O to V_{OUT} Throughout.....	4
Changes to Table 1.....	4
Changes to Table 2.....	6
Changes to Table 3.....	8
Changes to Table 5.....	12
Added Table 6; Renumbered Sequentially	12
Changes to Figure 13 Caption.....	14
Changes to Figure 29, Figure 31, and Figure 35	17
Changes to Figure 36.....	18
Changed Application Notes Section to Applications Information Section	20
Changes to Figure 46 and Figure 47.....	21
Changes to Figure 49.....	22
Changes to Figure 51.....	23

Typical Performance Characteristics	11
Applications Information	18
Input Characteristics.....	18
Output Characteristics.....	18
Single-Supply Voltage-to-Frequency Converter	19
Single-Supply Programmable Gain Instrumentation Amplifier	20
Low Dropout Bipolar Bridge Driver.....	20
Outline Dimensions	21
Ordering Guide	22

6/06—Rev. F to Rev. G

Changes to Features	1
Changes to Table 4.....	10
Changes to Table 5.....	12
Changes to Table 6.....	22

10/05—Rev. E to Rev. F

Updated Format.....	Universal
Changes to Outline Dimensions	24
Updated Ordering Guide	24

1/03—Data sheet changed from Rev. D to Rev. E

Edits to Specifications.....	2
Edits to Figure 10.....	16
Updated Outline Dimensions.....	17

10/02—Data sheet changed from Rev. C to Rev. D

Edits to Features.....	1
Edits to Ordering Guide	6
Updated SOIC Package Outline	17

8/02—Data sheet changed from Rev. B to Rev. C

All Figures Updated	Global
Edits to Features.....	1
Updated All Package Outlines	17

7/01—Data sheet changed from Rev. A to Rev. B

All Figures Updated	Global
CERDIP References Removed.....	1, 6, and 18
Additions to Product Description.....	1
8-Lead SOIC and 8-Lead MSOP Diagrams Added	1
Deletion of AD822S Column.....	2
Edits to Absolute Maximum Ratings and Ordering Guide	6
Removed Metallization Photograph	6

SPECIFICATIONS

$V_S = 0\text{ V}$, 5 V @ $T_A = 25^\circ\text{C}$, $V_{CM} = 0\text{ V}$, $V_{OUT} = 0.2\text{ V}$, unless otherwise noted.

Table 1.

Parameter	Conditions	A Grade			B Grade			Unit	
		Min	Typ	Max	Min	Typ	Max		
DC PERFORMANCE									
Initial Offset			0.1	0.8		0.1	0.4	mV	
Maximum Offset Over Temperature			0.5	1.2		0.5	0.9	mV	
Offset Drift			2			2		$\mu\text{V}/^\circ\text{C}$	
Input Bias Current	$V_{CM} = 0\text{ V to }4\text{ V}$		2	25		2	10	pA	
At T_{MAX}			0.5	5		0.5	2.5	nA	
Input Offset Current			2	20		2	10	pA	
At T_{MAX}			0.5			0.5		nA	
Open-Loop Gain	$V_{OUT} = 0.2\text{ V to }4\text{ V}$ $R_L = 100\text{ k}\Omega$		500	1000		500	1000	V/mV	
T_{MIN} to T_{MAX}			400			400		V/mV	
		$R_L = 10\text{ k}\Omega$		80	150		80	150	V/mV
T_{MIN} to T_{MAX}				80			80		V/mV
T_{MIN} to T_{MAX}		$R_L = 1\text{ k}\Omega$		15	30		15	30	V/mV
			10			10		V/mV	
NOISE/HARMONIC PERFORMANCE									
Input Voltage Noise									
f = 0.1 Hz to 10 Hz			2			2		$\mu\text{V p-p}$	
f = 10 Hz			25			25		$\text{nV}/\sqrt{\text{Hz}}$	
f = 100 Hz			21			21		$\text{nV}/\sqrt{\text{Hz}}$	
f = 1 kHz			16			16		$\text{nV}/\sqrt{\text{Hz}}$	
f = 10 kHz			13			13		$\text{nV}/\sqrt{\text{Hz}}$	
Input Current Noise									
f = 0.1 Hz to 10 Hz			18			18		fA p-p	
f = 1 kHz			0.8			0.8		fA/ $\sqrt{\text{Hz}}$	
Harmonic Distortion	$R_L = 10\text{ k}\Omega$ to 2.5 V $V_{OUT} = 0.25\text{ V to }4.75\text{ V}$								
f = 10 kHz				-93			-93		dB
DYNAMIC PERFORMANCE									
Unity-Gain Frequency			1.8			1.8		MHz	
Full Power Response	$V_{OUT p-p} = 4.5\text{ V}$		210			210		kHz	
Slew Rate			3			3		V/ μs	
Settling Time									
To 0.1%	$V_{OUT} = 0.2\text{ V to }4.5\text{ V}$		1.4			1.4		μs	
To 0.01%	$V_{OUT} = 0.2\text{ V to }4.5\text{ V}$		1.8			1.8		μs	
MATCHING CHARACTERISTICS									
Initial Offset				1.0			0.5	mV	
Maximum Offset Over Temperature				1.6			1.3	mV	
Offset Drift			3			3		$\mu\text{V}/^\circ\text{C}$	
Input Bias Current				20			10	pA	
Crosstalk @ f = 1 kHz	$R_L = 5\text{ k}\Omega$		-130			-130		dB	
Crosstalk @ f = 100 kHz	$R_L = 5\text{ k}\Omega$		-93			-93		dB	
INPUT CHARACTERISTICS									
Input Voltage Range ¹ , T_{MIN} to T_{MAX}		-0.2		+4	-0.2		+4	V	
Common-Mode Rejection Ratio (CMRR)	$V_{CM} = 0\text{ V to }2\text{ V}$	66	80		69	80		dB	
T_{MIN} to T_{MAX}	$V_{CM} = 0\text{ V to }2\text{ V}$	66			66			dB	

Parameter	Conditions	A Grade			B Grade			Unit
		Min	Typ	Max	Min	Typ	Max	
Input Impedance								
Differential			10 ¹³	0.5		10 ¹³	0.5	Ω pF
Common Mode			10 ¹³	2.8		10 ¹³	2.8	Ω pF
OUTPUT CHARACTERISTICS								
Output Saturation Voltage ²								
V _{OL} – V _{EE}	I _{SINK} = 20 μA		5	7		5	7	mV
T _{MIN} to T _{MAX}				10			10	mV
V _{CC} – V _{OH}	I _{SOURCE} = 20 μA		10	14		10	14	mV
T _{MIN} to T _{MAX}				20			20	mV
V _{OL} – V _{EE}	I _{SINK} = 2 mA		40	55		40	55	mV
T _{MIN} to T _{MAX}				80			80	mV
V _{CC} – V _{OH}	I _{SOURCE} = 2 mA		80	110		80	110	mV
T _{MIN} to T _{MAX}				160			160	mV
V _{OL} – V _{EE}	I _{SINK} = 15 mA		300	500		300	500	mV
T _{MIN} to T _{MAX}				1000			1000	mV
V _{CC} – V _{OH}	I _{SOURCE} = 15 mA		800	1500		800	1500	mV
T _{MIN} to T _{MAX}				1900			1900	mV
Operating Output Current		15			15			mA
T _{MIN} to T _{MAX}		12			12			mA
Capacitive Load Drive			350			350		pF
POWER SUPPLY								
Quiescent Current, T _{MIN} to T _{MAX}			1.24	1.6		1.24	1.6	mA
Power Supply Rejection	V ₊ = 5 V to 15 V	66	80		70	80		dB
T _{MIN} to T _{MAX}		66			70			dB

¹ This is a functional specification. Amplifier bandwidth decreases when the input common-mode voltage is driven in the range (V₊ – 1 V) to V₊. Common-mode error voltage is typically less than 5 mV with the common-mode voltage set at 1 V below the positive supply.

² V_{OL} – V_{EE} is defined as the difference between the lowest possible output voltage (V_{OL}) and the negative voltage supply rail (V_{EE}). V_{CC} – V_{OH} is defined as the difference between the highest possible output voltage (V_{OH}) and the positive supply voltage (V_{CC}).

AD822

$V_S = \pm 5\text{ V}$ @ $T_A = 25^\circ\text{C}$, $V_{CM} = 0\text{ V}$, $V_{OUT} = 0\text{ V}$, unless otherwise noted.

Table 2.

Parameter	Conditions	A Grade			B Grade			Unit	
		Min	Typ	Max	Min	Typ	Max		
DC PERFORMANCE									
Initial Offset	$V_{CM} = -5\text{ V to }+4\text{ V}$		0.1	0.8		0.1	0.4	mV	
Maximum Offset Over Temperature			0.5	1.5		0.5	1	mV	
Offset Drift				2			2	$\mu\text{V}/^\circ\text{C}$	
Input Bias Current				2	25		2	10	pA
At T_{MAX}				0.5	5		0.5	2.5	nA
Input Offset Current				2	20		2	10	pA
At T_{MAX}				0.5			0.5	nA	
Open-Loop Gain	$V_{OUT} = -4\text{ V to }+4\text{ V}$ $R_L = 100\text{ k}\Omega$		400	1000		400	1000	V/mV	
T_{MIN} to T_{MAX}			400			400		V/mV	
		$R_L = 10\text{ k}\Omega$		80	150		80	150	V/mV
T_{MIN} to T_{MAX}				80			80		V/mV
		$R_L = 1\text{ k}\Omega$		20	30		20	30	V/mV
T_{MIN} to T_{MAX}			10			10		V/mV	
NOISE/HARMONIC PERFORMANCE									
Input Voltage Noise	$R_L = 10\text{ k}\Omega$ $V_{OUT} = \pm 4.5\text{ V}$								
f = 0.1 Hz to 10 Hz			2			2		$\mu\text{V p-p}$	
f = 10 Hz			25			25		$\text{nV}/\sqrt{\text{Hz}}$	
f = 100 Hz			21			21		$\text{nV}/\sqrt{\text{Hz}}$	
f = 1 kHz			16			16		$\text{nV}/\sqrt{\text{Hz}}$	
f = 10 kHz			13			13		$\text{nV}/\sqrt{\text{Hz}}$	
Input Current Noise									
f = 0.1 Hz to 10 Hz				18			18	fA p-p	
f = 1 kHz				0.8			0.8	fA/ $\sqrt{\text{Hz}}$	
Harmonic Distortion									
f = 10 kHz			-93			-93	dB		
DYNAMIC PERFORMANCE									
Unity-Gain Frequency	$V_{OUT\text{ p-p}} = 9\text{ V}$		1.9			1.9		MHz	
Full Power Response				105			105		kHz
Slew Rate				3			3		V/ μs
Settling Time	$V_{OUT} = 0\text{ V to } \pm 4.5\text{ V}$ $V_{OUT} = 0\text{ V to } \pm 4.5\text{ V}$		1.4			1.4		μs	
to 0.1%				1.8			1.8		μs
to 0.01%									
MATCHING CHARACTERISTICS									
Initial Offset	$R_L = 5\text{ k}\Omega$ $R_L = 5\text{ k}\Omega$			1.0			0.5	mV	
Maximum Offset Over Temperature					3			2	mV
Offset Drift				3			3	$\mu\text{V}/^\circ\text{C}$	
Input Bias Current					25			10	pA
Crosstalk @ f = 1 kHz				-130			-130		dB
Crosstalk @ f = 100 kHz				-93			-93		dB
INPUT CHARACTERISTICS									
Input Voltage Range ¹ , T_{MIN} to T_{MAX}	$V_{CM} = -5\text{ V to }+2\text{ V}$ $V_{CM} = -5\text{ V to }+2\text{ V}$		-5.2		+4			V	
Common-Mode Rejection Ratio (CMRR)			66	80		69	80		dB
T_{MIN} to T_{MAX}			66			66			dB
Input Impedance									
Differential				$10^{13} 0.5$		$10^{13} 0.5$		ΩpF	
Common Mode				$10^{13} 2.8$		$10^{13} 2.8$		ΩpF	

Parameter	Conditions	A Grade			B Grade			Unit
		Min	Typ	Max	Min	Typ	Max	
OUTPUT CHARACTERISTICS								
Output Saturation Voltage ²								
$V_{OL} - V_{EE}$	$I_{SINK} = 20 \mu A$		5	7		5	7	mV
T_{MIN} to T_{MAX}				10			10	mV
$V_{CC} - V_{OH}$	$I_{SOURCE} = 20 \mu A$		10	14		10	14	mV
T_{MIN} to T_{MAX}				20			20	mV
$V_{OL} - V_{EE}$	$I_{SINK} = 2 mA$		40	55		40	55	mV
T_{MIN} to T_{MAX}				80			80	mV
$V_{CC} - V_{OH}$	$I_{SOURCE} = 2 mA$		80	110		80	110	mV
T_{MIN} to T_{MAX}				160			160	mV
$V_{OL} - V_{EE}$	$I_{SINK} = 15 mA$		300	500		300	500	mV
T_{MIN} to T_{MAX}				1000			1000	mV
$V_{CC} - V_{OH}$	$I_{SOURCE} = 15 mA$		800	1500		800	1500	mV
T_{MIN} to T_{MAX}				1900			1900	mV
Operating Output Current		15			15			mA
T_{MIN} to T_{MAX}		12			12			mA
Capacitive Load Drive			350			350		pF
POWER SUPPLY								
Quiescent Current, T_{MIN} to T_{MAX}			1.3	1.6		1.3	1.6	mA
Power Supply Rejection	$V_{SY} = \pm 5 V$ to $\pm 15 V$	66	80		70	80		dB
T_{MIN} to T_{MAX}		66			70			dB

¹ This is a functional specification. Amplifier bandwidth decreases when the input common-mode voltage is driven in the range $(V_+ - 1 V)$ to V_+ . Common-mode error voltage is typically less than 5 mV with the common-mode voltage set at 1 V below the positive supply.

² $V_{OL} - V_{EE}$ is defined as the difference between the lowest possible output voltage (V_{OL}) and the negative voltage supply rail (V_{EE}). $V_{CC} - V_{OH}$ is defined as the difference between the highest possible output voltage (V_{OH}) and the positive supply voltage (V_{CC}).

AD822

$V_S = \pm 15\text{ V}$ @ $T_A = 25^\circ\text{C}$, $V_{CM} = 0\text{ V}$, $V_{OUT} = 0\text{ V}$, unless otherwise noted.

Table 3.

Parameter	Conditions	A Grade			B Grade			Unit
		Min	Typ	Max	Min	Typ	Max	
DC PERFORMANCE								
Initial Offset			0.4	2		0.3	1.5	mV
Maximum Offset Over Temperature			0.5	3		0.5	2.5	mV
Offset Drift			2			2		$\mu\text{V}/^\circ\text{C}$
Input Bias Current	$V_{CM} = 0\text{ V}$		2	25		2	12	pA
	$V_{CM} = -10\text{ V}$		40			40		pA
At T_{MAX}	$V_{CM} = 0\text{ V}$		0.5	5		0.5	2.5	nA
Input Offset Current			2	20		2	12	pA
At T_{MAX}			0.5			0.5		nA
Open-Loop Gain	$V_{OUT} = -10\text{ V to }+10\text{ V}$							
	$R_L = 100\text{ k}\Omega$	500	2000		500	2000		V/mV
T_{MIN} to T_{MAX}		500			500			V/mV
	$R_L = 10\text{ k}\Omega$	100	500		100	500		V/mV
T_{MIN} to T_{MAX}		100			100			V/mV
	$R_L = 1\text{ k}\Omega$	30	45		30	45		V/mV
T_{MIN} to T_{MAX}		20			20			V/mV
NOISE/HARMONIC PERFORMANCE								
Input Voltage Noise								
f = 0.1 Hz to 10 Hz			2			2		$\mu\text{V p-p}$
f = 10 Hz			25			25		nV/ $\sqrt{\text{Hz}}$
f = 100 Hz			21			21		nV/ $\sqrt{\text{Hz}}$
f = 1 kHz			16			16		nV/ $\sqrt{\text{Hz}}$
f = 10 kHz			13			13		nV/ $\sqrt{\text{Hz}}$
Input Current Noise								
f = 0.1 Hz to 10 Hz			18			18		fA p-p
f = 1 kHz			0.8			0.8		fA/ $\sqrt{\text{Hz}}$
Harmonic Distortion	$R_L = 10\text{ k}\Omega$							
f = 10 kHz	$V_{OUT} = \pm 10\text{ V}$		-85			-85		dB
DYNAMIC PERFORMANCE								
Unity-Gain Frequency			1.9			1.9		MHz
Full Power Response	$V_{OUT\text{ p-p}} = 20\text{ V}$		45			45		kHz
Slew Rate			3			3		V/ μs
Settling Time								
to 0.1%	$V_{OUT} = 0\text{ V to } \pm 10\text{ V}$		4.1			4.1		μs
to 0.01%	$V_{OUT} = 0\text{ V to } \pm 10\text{ V}$		4.5			4.5		μs
MATCHING CHARACTERISTICS								
Initial Offset				3			2	mV
Maximum Offset Over Temperature				4			2.5	mV
Offset Drift			3			3		$\mu\text{V}/^\circ\text{C}$
Input Bias Current				25			12	pA
Crosstalk @ f = 1 kHz	$R_L = 5\text{ k}\Omega$		-130			-130		dB
Crosstalk @ f = 100 kHz	$R_L = 5\text{ k}\Omega$		-93			-93		dB
INPUT CHARACTERISTICS								
Input Voltage Range ¹ , T_{MIN} to T_{MAX}		-15.2		+14	-15.2		+14	V
Common-Mode Rejection Ratio (CMRR)	$V_{CM} = -15\text{ V to }+12\text{ V}$	70	80		74	90		dB
T_{MIN} to T_{MAX}	$V_{CM} = -15\text{ V to }+12\text{ V}$	70			74			dB
Input Impedance								
Differential			$10^{13} 0.5$			$10^{13} 0.5$		ΩpF
Common Mode			$10^{13} 2.8$			$10^{13} 2.8$		ΩpF

Parameter	Conditions	A Grade			B Grade			Unit
		Min	Typ	Max	Min	Typ	Max	
OUTPUT CHARACTERISTICS								
Output Saturation Voltage ²								
$V_{OL} - V_{EE}$	$I_{SINK} = 20 \mu A$		5	7		5	7	mV
T_{MIN} to T_{MAX}				10			10	mV
$V_{CC} - V_{OH}$	$I_{SOURCE} = 20 \mu A$		10	14		10	14	mV
T_{MIN} to T_{MAX}				20			20	mV
$V_{OL} - V_{EE}$	$I_{SINK} = 2 mA$		40	55		40	55	mV
T_{MIN} to T_{MAX}				80			80	mV
$V_{CC} - V_{OH}$	$I_{SOURCE} = 2 mA$		80	110		80	110	mV
T_{MIN} to T_{MAX}				160			160	mV
$V_{OL} - V_{EE}$	$I_{SINK} = 15 mA$		300	500		300	500	mV
T_{MIN} to T_{MAX}				1000			1000	mV
$V_{CC} - V_{OH}$	$I_{SOURCE} = 15 mA$		800	1500		800	1500	mV
T_{MIN} to T_{MAX}				1900			1900	mV
Operating Output Current		20			20			mA
T_{MIN} to T_{MAX}		15			15			mA
Capacitive Load Drive			350			350		pF
POWER SUPPLY								
Quiescent Current, T_{MIN} to T_{MAX}			1.4	1.8		1.4	1.8	mA
Power Supply Rejection	$V_{SY} = \pm 5 V$ to $\pm 15 V$	70	80		70	80		dB
T_{MIN} to T_{MAX}		70			70			dB

¹ This is a functional specification. Amplifier bandwidth decreases when the input common-mode voltage is driven in the range ($V+ - 1 V$) to $V+$. Common-mode error voltage is typically less than 5 mV with the common-mode voltage set at 1 V below the positive supply.

² $V_{OL} - V_{EE}$ is defined as the difference between the lowest possible output voltage (V_{OL}) and the negative voltage supply rail (V_{EE}). $V_{CC} - V_{OH}$ is defined as the difference between the highest possible output voltage (V_{OH}) and the positive supply voltage (V_{CC}).

ABSOLUTE MAXIMUM RATINGS

Table 4.

Parameter	Rating
Supply Voltage	± 18 V
Internal Power Dissipation	
8-Lead PDIP (N)	Observe derating curves
8-Lead SOIC_N (R)	Observe derating curves
8-Lead MSOP (RM)	Observe derating curves
Input Voltage ¹	((V+) + 0.2 V) to ((V-) - 20 V)
Output Short-Circuit Duration	Indefinite
Differential Input Voltage	± 30 V
Storage Temperature Range (N)	-65°C to +125°C
Storage Temperature Range (R, RM)	-65°C to +150°C
Operating Temperature Range	
A Grade and B Grade	-40°C to +85°C
Lead Temperature (Soldering, 60 sec)	260°C

¹ See the Input Characteristics section.

Stresses above those listed under Absolute Maximum Ratings may cause permanent damage to the device. This is a stress rating only; functional operation of the device at these or any other conditions above those indicated in the operational section of this specification is not implied. Exposure to absolute maximum rating conditions for extended periods may affect device reliability.

THERMAL RESISTANCE

θ_{JA} is specified for the worst-case conditions, that is, a device soldered in a circuit board for surface-mount packages.

Table 5. Thermal Resistance

Package Type	θ_{JA}	Unit
8-lead PDIP (N)	90	°C/W
8-lead SOIC_N (R)	160	°C/W
8-lead MSOP (RM)	190	°C/W

MAXIMUM POWER DISSIPATION

The maximum power that can be safely dissipated by the AD822 is limited by the associated rise in junction temperature. For plastic packages, the maximum safe junction temperature is 145°C. If these maximums are exceeded momentarily, proper circuit operation is restored as soon as the die temperature is reduced. Leaving the device in the overheated condition for an extended period can result in device burnout. To ensure proper operation, it is important to observe the derating curves shown in Figure 27.

While the AD822 is internally short-circuit protected, this may not be sufficient to guarantee that the maximum junction temperature is not exceeded under all conditions. With power supplies ± 12 V (or less) at an ambient temperature of 25°C or less, if the output node is shorted to a supply rail, then the amplifier is not destroyed, even if this condition persists for an extended period.

ESD CAUTION



ESD (electrostatic discharge) sensitive device. Charged devices and circuit boards can discharge without detection. Although this product features patented or proprietary protection circuitry, damage may occur on devices subjected to high energy ESD. Therefore, proper ESD precautions should be taken to avoid performance degradation or loss of functionality.

TYPICAL PERFORMANCE CHARACTERISTICS

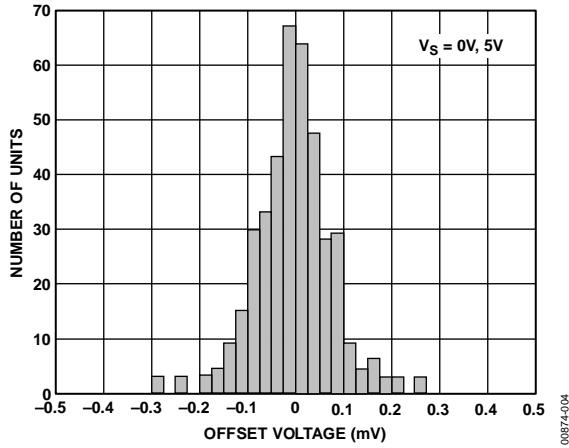

Figure 4. Typical Distribution of Offset Voltage (390 Units)

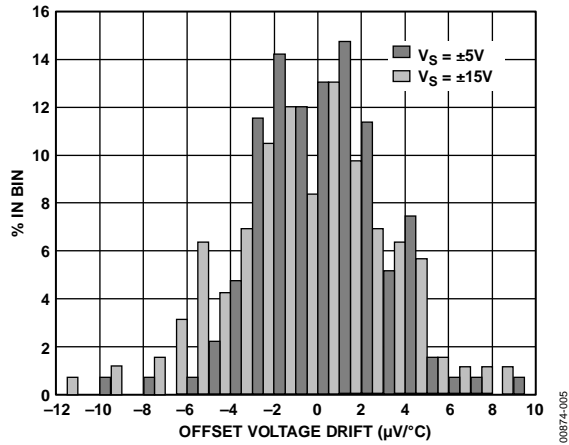

Figure 5. Typical Distribution of Offset Voltage Drift (100 Units)

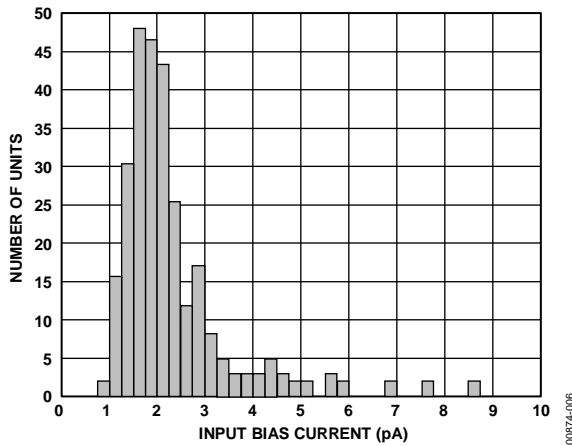

Figure 6. Typical Distribution of Input Bias Current (213 Units)

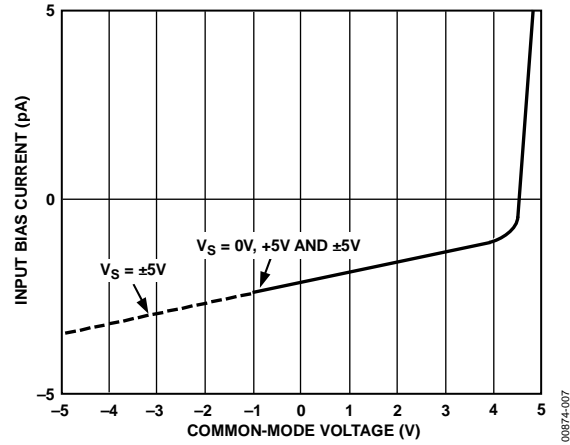

Figure 7. Input Bias Current vs. Common-Mode Voltage; $V_S = 5\text{ V}, 0\text{ V},$ and $V_S = \pm 5\text{ V}$

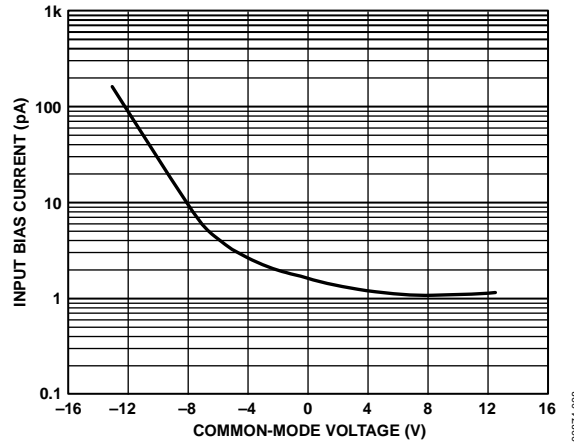

Figure 8. Input Bias Current vs. Common-Mode Voltage; $V_S = \pm 15\text{ V}$

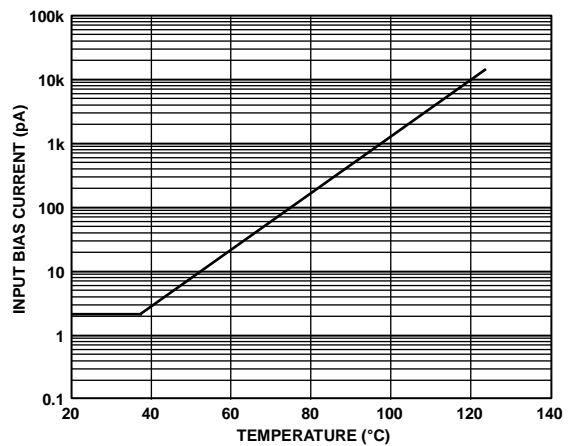

Figure 9. Input Bias Current vs. Temperature; $V_S = 5\text{ V}, V_{CM} = 0\text{ V}$

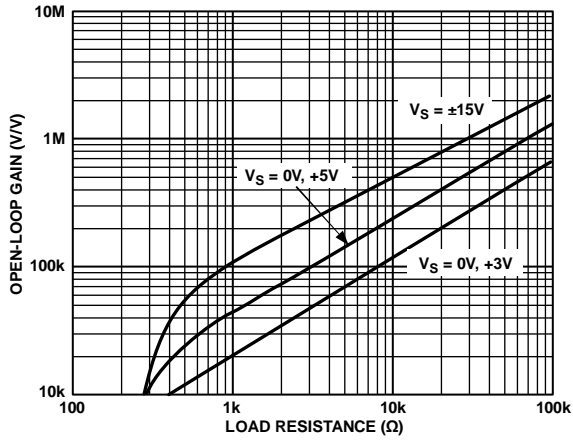

Figure 10. Open-Loop Gain vs. Load Resistance

00874-010

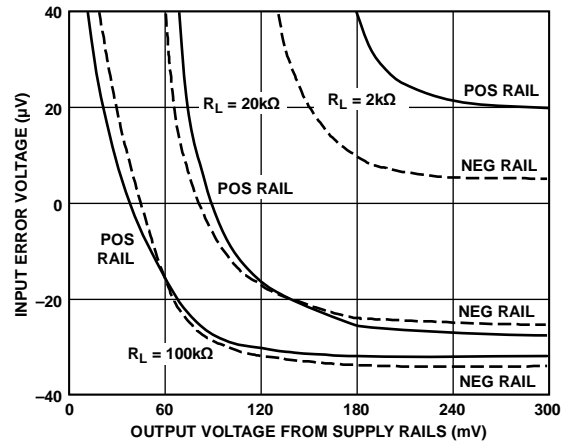

Figure 13. Input Error Voltage with Output Voltage Within 300 mV of Either Supply Rail for Various Resistive Loads; $V_S = \pm 5 V$

00874-013

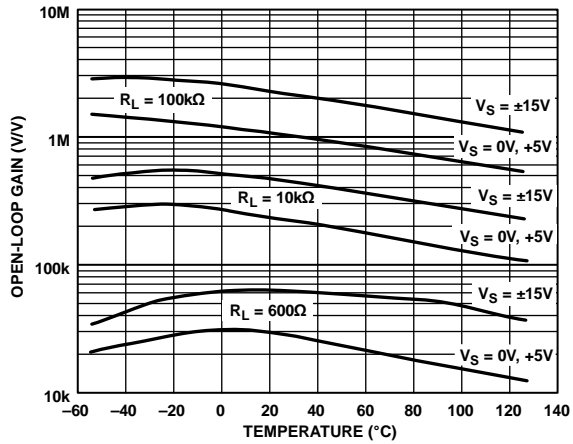

Figure 11. Open-Loop Gain vs. Temperature

00874-011

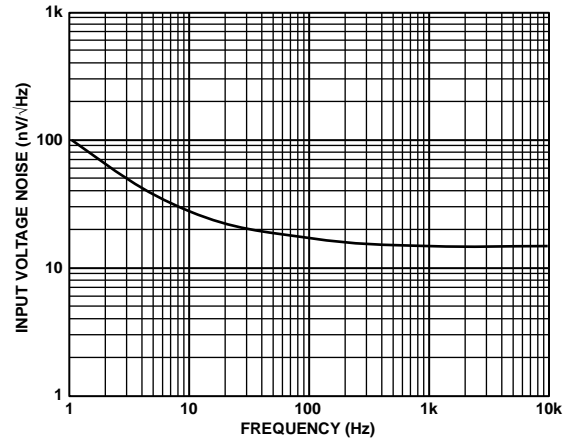

Figure 14. Input Voltage Noise vs. Frequency

00874-014

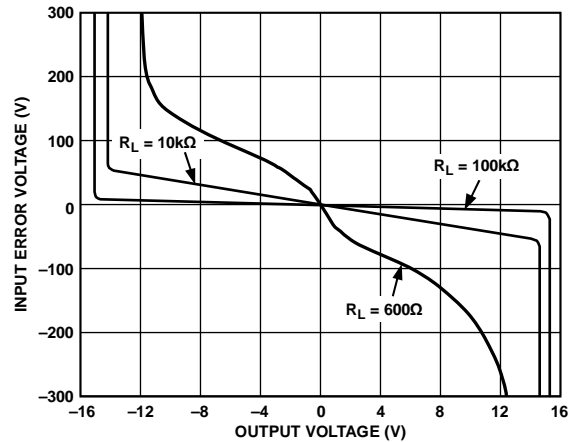

Figure 12. Input Error Voltage vs. Output Voltage for Resistive Loads

00874-012

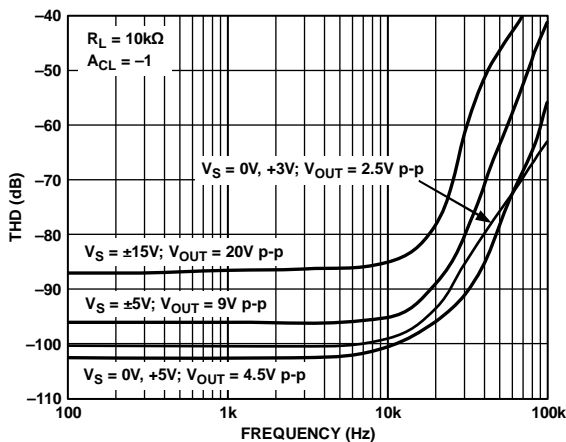

Figure 15. Total Harmonic Distortion (THD) vs. Frequency

00874-015

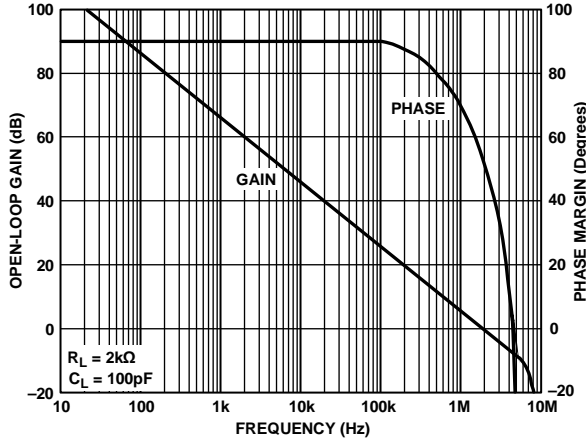

Figure 16. Open-Loop Gain and Phase Margin vs. Frequency

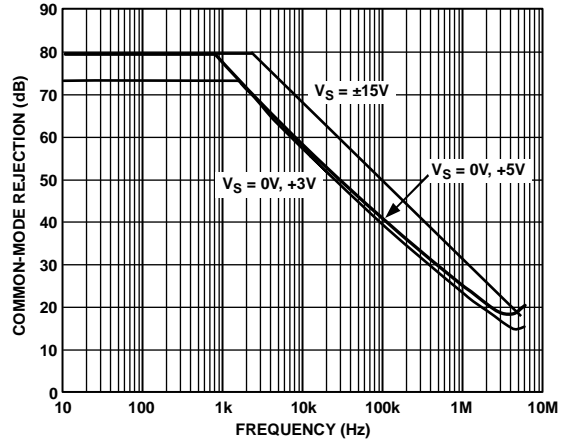

Figure 19. Common-Mode Rejection vs. Frequency

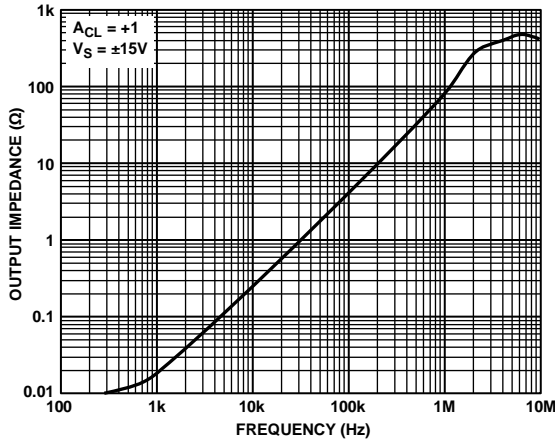

Figure 17. Output Impedance vs. Frequency

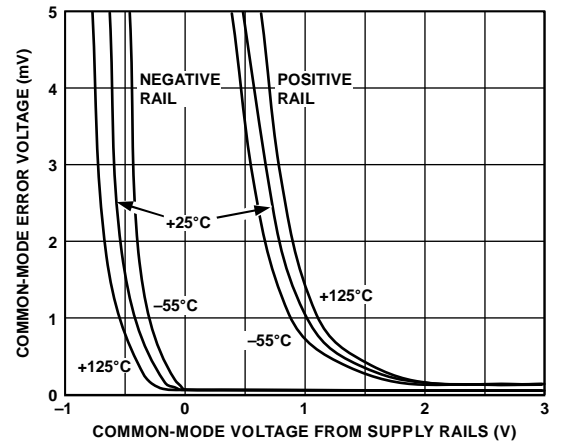

Figure 20. Absolute Common-Mode Error vs. Common-Mode Voltage from Supply Rails ($V_S - V_{CM}$)

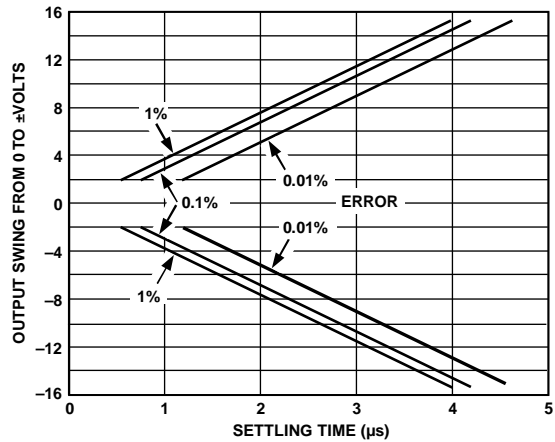

Figure 18. Output Swing and Error vs. Settling Time

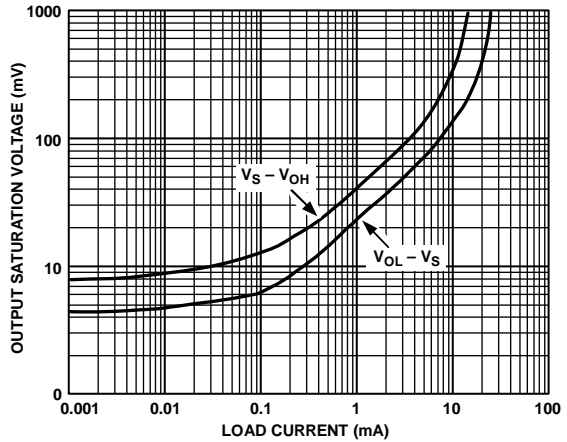

Figure 21. Output Saturation Voltage vs. Load Current

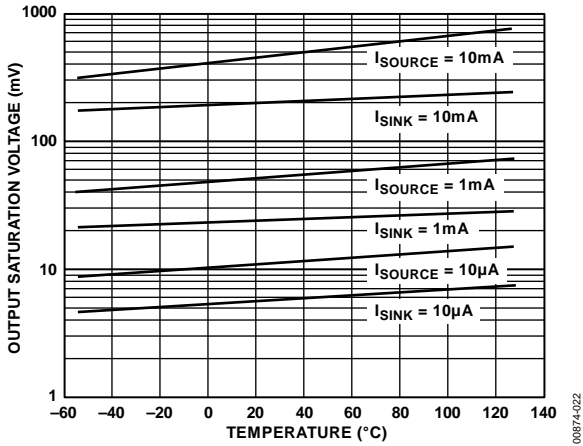

Figure 22. Output Saturation Voltage vs. Temperature

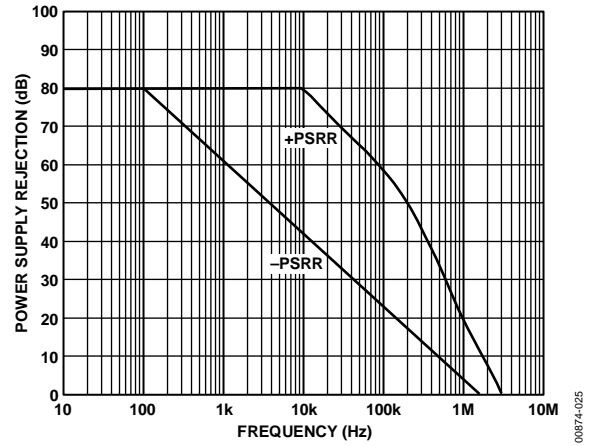

Figure 25. Power Supply Rejection vs. Frequency

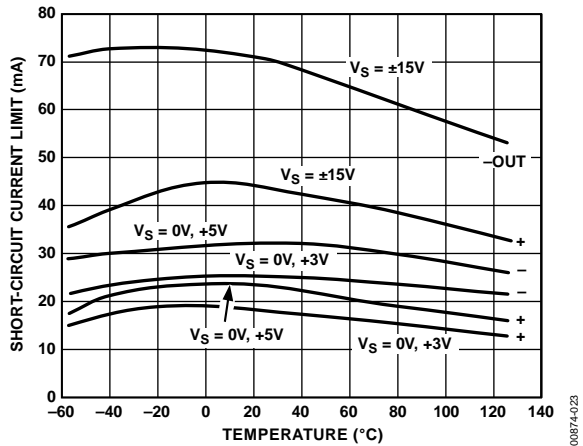

Figure 23. Short-Circuit Current Limit vs. Temperature

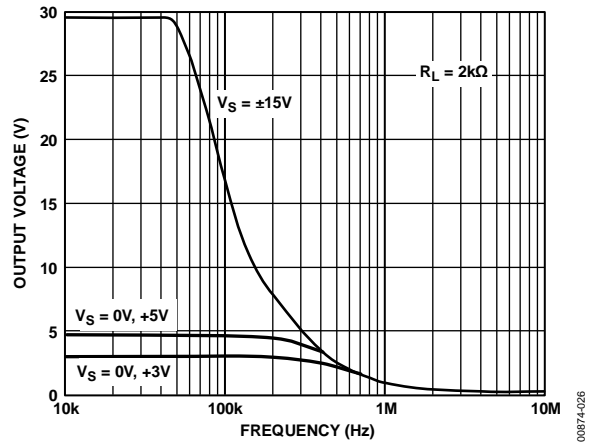

Figure 26. Large Signal Frequency Response

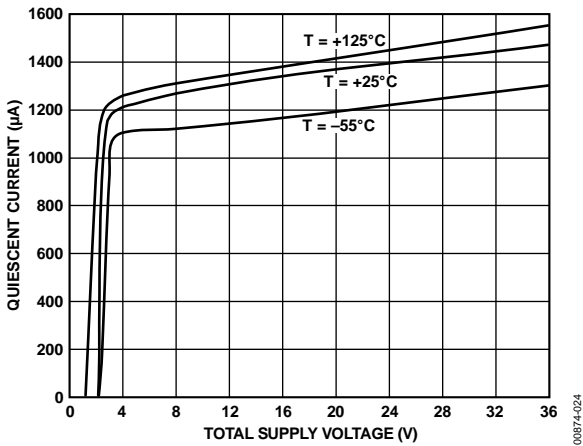

Figure 24. Quiescent Current vs. Supply Voltage vs. Temperature

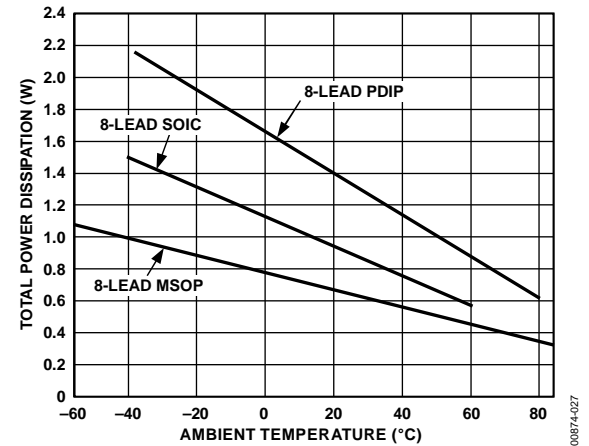

Figure 27. Maximum Power Dissipation vs. Temperature for Packages

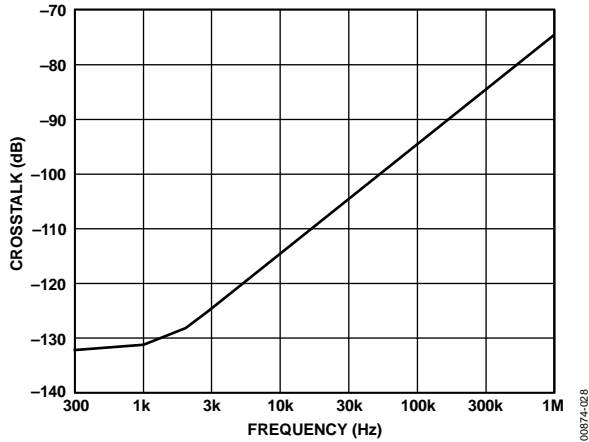

Figure 28. Crosstalk vs. Frequency

00874-028

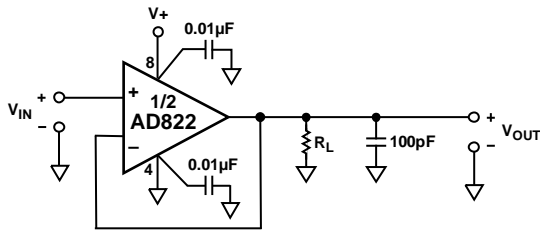

Figure 29. Unity-Gain Follower

00874-029

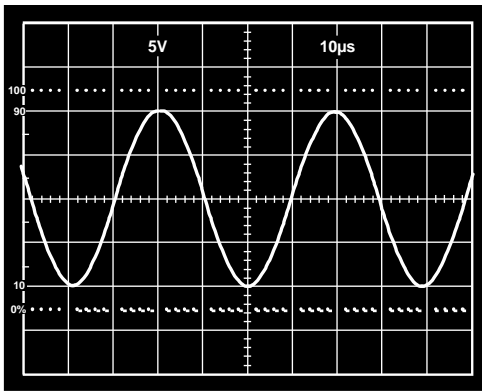

Figure 30. 20 V p-p, 25 kHz Sine Wave Input; Unity-Gain Follower; $V_s = \pm 15\text{ V}$, $R_L = 600\ \Omega$

00874-030

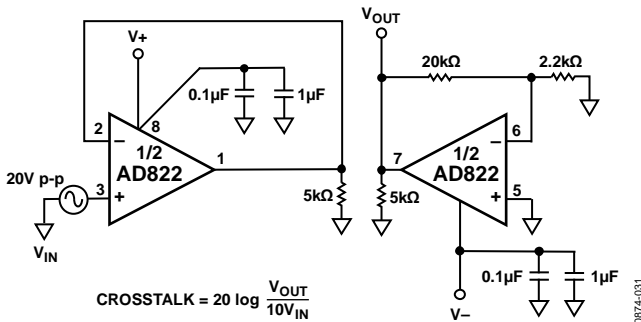

Figure 31. Crosstalk Test Circuit

00874-031

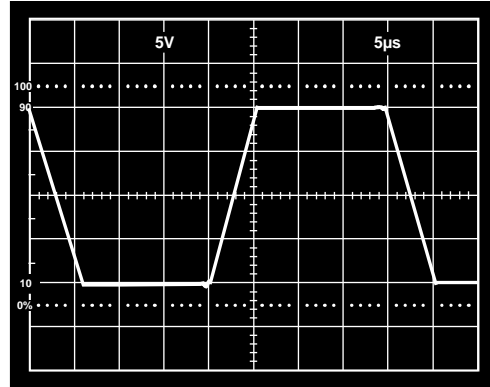

Figure 32. Large Signal Response Unity-Gain Follower; $V_s = \pm 15\text{ V}$, $R_L = 10\text{ k}\Omega$

00874-032

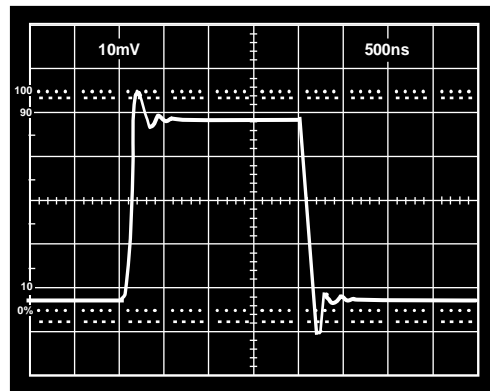

Figure 33. Small Signal Response Unity-Gain Follower; $V_s = \pm 15\text{ V}$, $R_L = 10\text{ k}\Omega$

00874-033

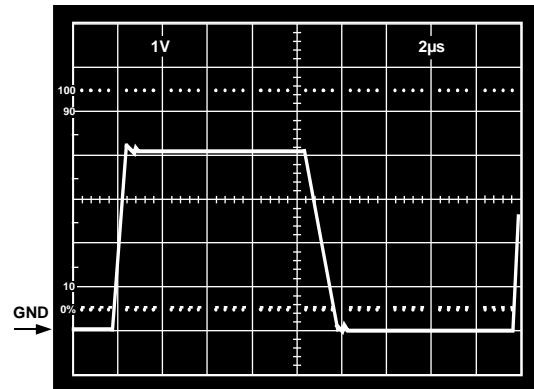

Figure 34. $V_s = 5\text{ V}$, 0 V; Unity-Gain Follower Response to 0 V to 4 V Step

00874-034

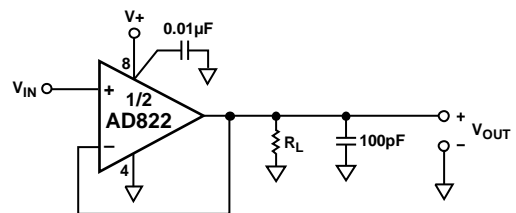

Figure 35. Unity-Gain Follower

00874-035

AD822

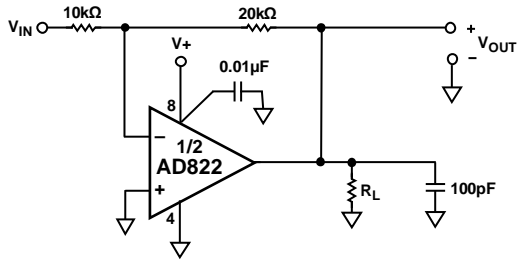

Figure 36. Gain-of-Two Inverter

00874-036

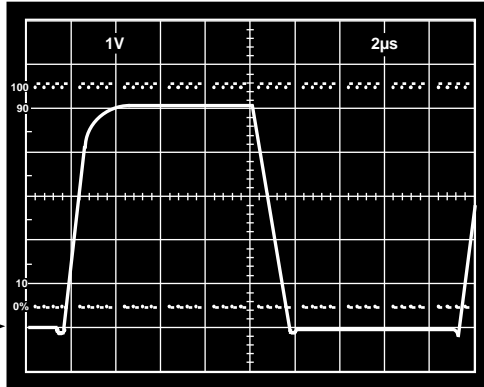

Figure 37. $V_S = 5\text{ V}$, 0 V ; Unity-Gain Follower Response to 0 V to 5 V Step

00874-037

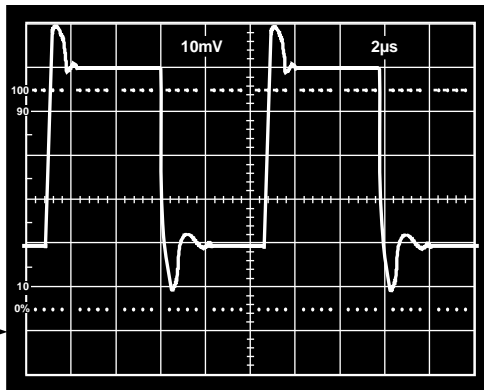

Figure 38. $V_S = 5\text{ V}$, 0 V ; Unity-Gain Follower Response to 40 mV Step, Centered 40 mV above Ground, $R_L = 10\text{ k}\Omega$

00874-038

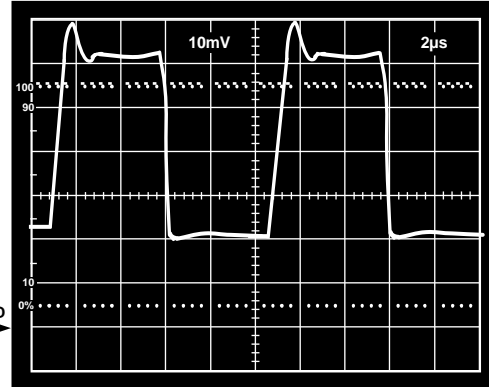

Figure 39. $V_S = 5\text{ V}$, 0 V ; Gain-of-2 Inverter Response to 20 mV Step, Centered 20 mV Below Ground, $R_L = 10\text{ k}\Omega$

00874-039

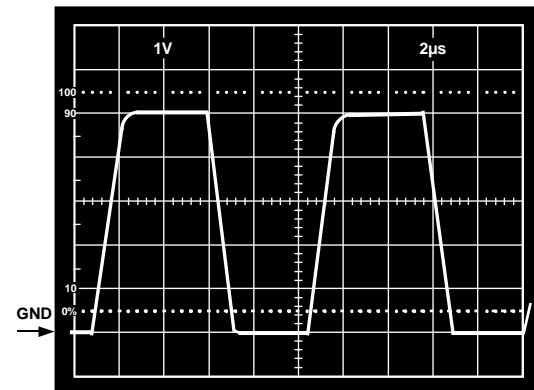

Figure 40. $V_S = 5\text{ V}$, 0 V ; Gain-of-2 Inverter Response to 2.5 V Step, Centered -1.25 V Below Ground, $R_L = 10\text{ k}\Omega$

00874-040

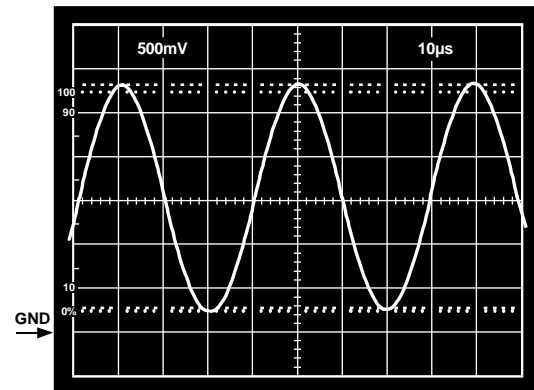
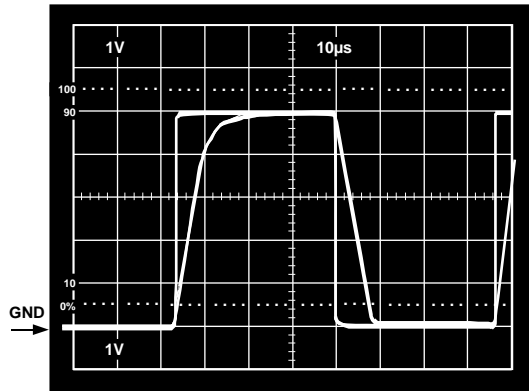
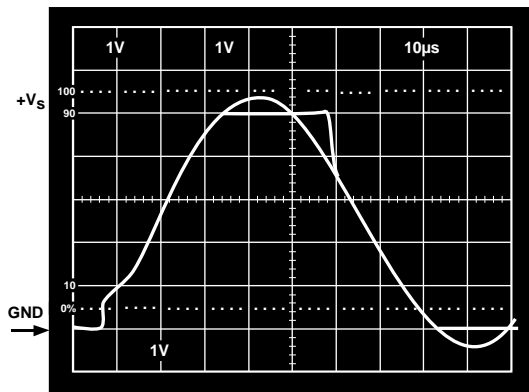

Figure 41. $V_S = 3\text{ V}$, 0 V ; Gain-of-2 Inverter, $V_{IN} = 1.25\text{ V}$, 25 kHz , Sine Wave Centered at -0.75 V , $R_L = 600\ \Omega$

00874-041



(a)



(b)

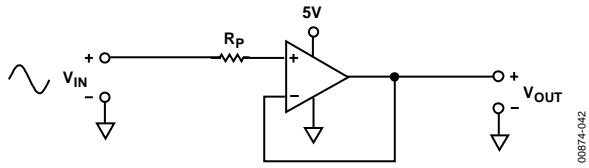

Figure 42. (a) Response with $R_P = 0$; V_{IN} from 0 V to $+V_S$
 (b) $V_{IN} = 0$ V to $+V_S + 200$ mV
 $V_{OUT} = 0$ V to $+V_S$
 $R_P = 49.9$ k Ω

00874-042

APPLICATIONS INFORMATION

INPUT CHARACTERISTICS

In the AD822, N-channel JFETs are used to provide a low offset, low noise, high impedance input stage. Minimum input common-mode voltage extends from 0.2 V below $-V_s$ to 1 V less than $+V_s$. Driving the input voltage closer to the positive rail causes a loss of amplifier bandwidth (as can be seen by comparing the large signal responses shown in Figure 34 and Figure 37) and increased common-mode voltage error as illustrated in Figure 20.

The AD822 does not exhibit phase reversal for input voltages up to and including $+V_s$. Figure 42 shows the response of an AD822 voltage follower to a 0 V to 5 V ($+V_s$) square wave input. The input and output are superimposed. The output tracks the input up to $+V_s$ without phase reversal. The reduced bandwidth above a 4 V input causes the rounding of the output waveform. For input voltages greater than $+V_s$, a resistor in series with the AD822 noninverting input prevents phase reversal, at the expense of greater input voltage noise. This is illustrated in Figure 42.

Because the input stage uses N-channel JFETs, input current during normal operation is negative; the current flows out from the input terminals. If the input voltage is driven more positive than $+V_s - 0.4$ V, then the input current reverses direction as internal device junctions become forward biased. This is illustrated in Figure 7.

A current limiting resistor should be used in series with the input of the AD822 if there is a possibility of the input voltage exceeding the positive supply by more than 300 mV, or if an input voltage is applied to the AD822 when $+V_s$ or $-V_s = 0$ V. The amplifier is damaged if left in that condition for more than 10 seconds. A 1 k Ω resistor allows the amplifier to withstand up to 10 V of continuous overvoltage and increases the input voltage noise by a negligible amount.

Input voltages less than $-V_s$ are a completely different story. The amplifier can safely withstand input voltages 20 V below the negative supply voltage if the total voltage from the positive supply to the input terminal is less than 36 V. In addition, the input stage typically maintains picoampere (pA) level input currents across that input voltage range.

The AD822 is designed for 13 nV/ $\sqrt{\text{Hz}}$ wideband input voltage noise and maintains low noise performance to low frequencies (refer to Figure 14). This noise performance, along with the AD822 low input current and current noise, means that the AD822 contributes negligible noise for applications with source resistances greater than 10 k Ω and signal bandwidths greater than 1 kHz. This is illustrated in Figure 43.

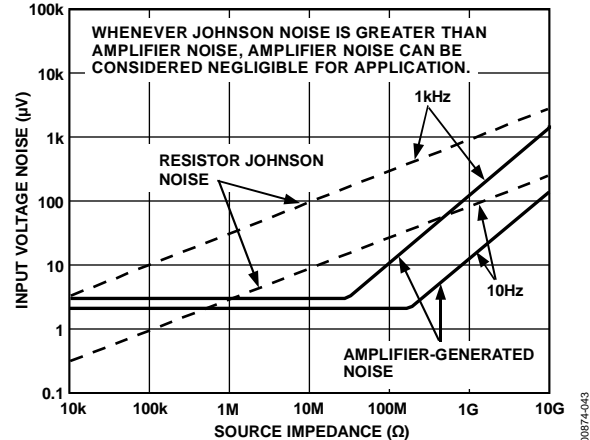

Figure 43. Total Noise vs. Source Impedance

OUTPUT CHARACTERISTICS

The AD822 unique bipolar rail-to-rail output stage swings within 5 mV of the negative supply and 10 mV of the positive supply with no external resistive load. The approximate output saturation resistance of the AD822 is 40 Ω sourcing and 20 Ω sinking, which can be used to estimate output saturation voltage when driving heavier current loads. For instance, when sourcing 5 mA, the saturation voltage to the positive supply rail is 200 mV; when sinking 5 mA, the saturation voltage to the negative rail is 100 mV.

The open-loop gain characteristic of the amplifier changes as a function of resistive load, as shown in Figure 10 to Figure 13. For load resistances over 20 k Ω , the AD822 input error voltage is virtually unchanged until the output voltage is driven to 180 mV of either supply.

If the AD822 output is overdriven so that either of the output devices are saturated, the amplifier recovers within 2 μs of its input returning to the linear operating region of the amplifier.

Direct capacitive loads interact with the effective output impedance of the amplifier to form an additional pole in the amplifier feedback loop, which can cause excessive peaking on the pulse response or loss of stability. The worst case occurs when the amplifier is used as a unity-gain follower. Figure 44 shows the AD822 pulse response as a unity-gain follower driving 350 pF. This amount of overshoot indicates approximately 20° of phase margin—the system is stable, but nearing the edge. Configurations with less loop gain, and as a result less loop bandwidth, are much less sensitive to capacitance load effects.

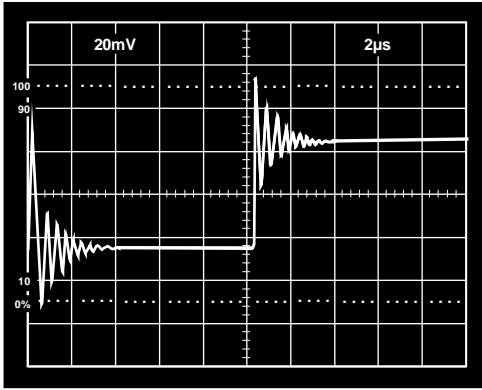

Figure 44. Small Signal Response of AD822 as Unity-Gain Follower Driving 350 pF

Figure 45 is a plot of noise gain vs. capacitive load that results in a 20° phase margin for the AD822. Noise gain is the inverse of the feedback attenuation factor provided by the feedback network in use.

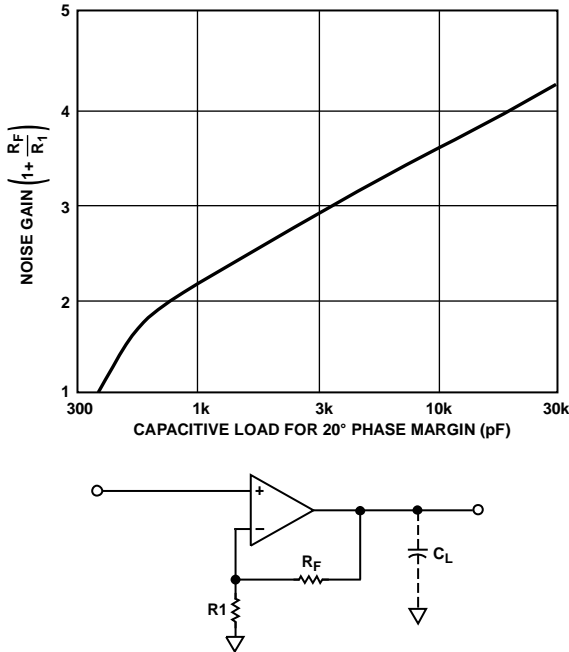

Figure 45. Noise Gain vs. Capacitive Load Tolerance

Figure 46 shows a method for extending capacitance load drive capability for a unity-gain follower. With these component values, the circuit drives 5000 pF with a 10% overshoot.

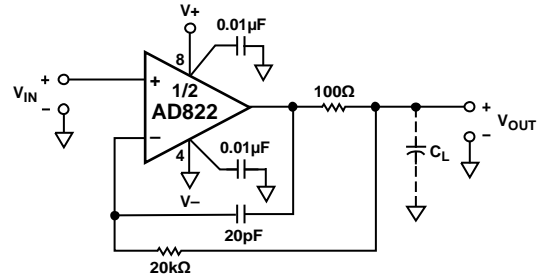

Figure 46. Extending Unity-Gain Follower Capacitive Load Capability Beyond 350 pF

SINGLE-SUPPLY VOLTAGE-TO-FREQUENCY CONVERTER

The circuit shown in Figure 47 uses the AD822 to drive a low power timer that produces a stable pulse of width t_1 . The positive going output pulse is integrated by R1 and C1 and used as one input to the AD822 that is connected as a differential integrator. The other input (nonloading) is the unknown voltage, V_{IN} . The AD822 output drives the timer trigger input, closing the overall feedback loop.

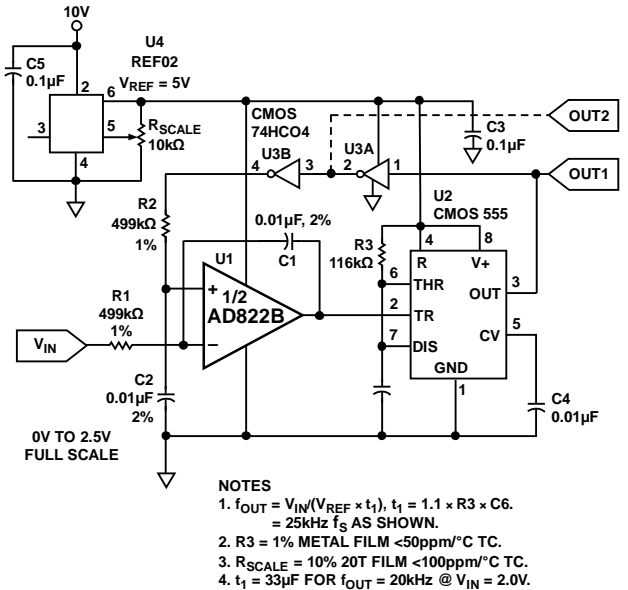

Figure 47. Single-Supply Voltage-to-Frequency Converter

Typical AD822 bias currents of 2 pA allow MΩ range source impedances with negligible dc errors. Linearity errors on the order of 0.01% full scale can be achieved with this circuit. This performance is obtained with a 5 V single supply that delivers less than 1 mA to the entire circuit.

AD822

SINGLE-SUPPLY PROGRAMMABLE GAIN INSTRUMENTATION AMPLIFIER

The AD822 can be configured as a single-supply instrumentation amplifier that is able to operate from single supplies down to 3 V or dual supplies up to ±15 V. Using only one AD822 rather than three separate op amps, this circuit is cost and power efficient. The 2 pA bias currents of the AD822 FET inputs minimize offset errors caused by high unbalanced source impedances.

An array of precision thin film resistors sets the in-amp gain to be either 10 or 100. These resistors are laser trimmed to ratio match to 0.01% and have a maximum differential TC of 5 ppm/°C.

Table 6. In-Amp Performance

Parameters	V _S = 3 V, 0 V	V _S = ±5 V
CMRR	74 dB	80 dB
Common-Mode Voltage Range	-0.2 V to +2 V	-5.2 V to +4 V
3 dB BW		
G = 10	180 kHz	180 kHz
G = 100	18 kHz	18 kHz
t _{SETTLING}		
2 V Step	2 μs	
5 V Step		5 μs
Noise @ f = 1 kHz		
G = 10	270 nV/√Hz	270 nV/√Hz
G = 100	2.2 μV/√Hz	2.2 μV/√Hz
I _{SUPPLY} (Total)	1.10 mA	1.15 mA

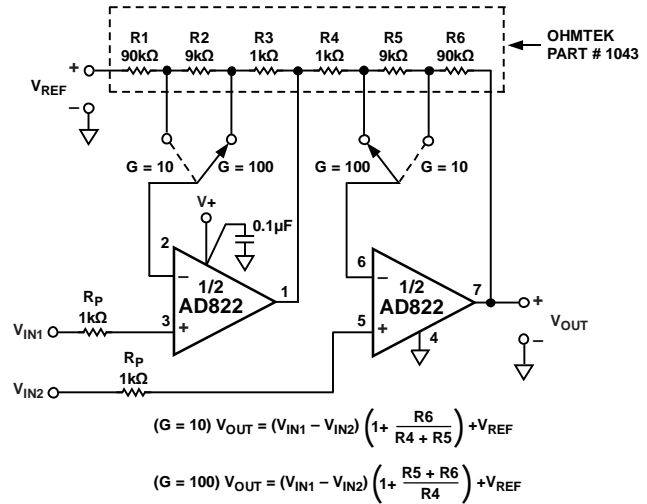

Figure 49. A Single-Supply Programmable Instrumentation Amplifier

LOW DROPOUT BIPOLAR BRIDGE DRIVER

The AD822 can be used for driving a 350 Ω Wheatstone bridge. Figure 50 shows one-half of the AD822 being used to buffer the AD589, a 1.235 V low power reference. The output of 4.5 V can be used to drive an analog-to-digital converter (ADC) front end. The other half of the AD822 is configured as a unity-gain inverter and generates the other bridge input of -4.5 V. Resistor R1 and Resistor R2 provide a constant current for bridge excitation. The AD620 low power instrumentation amplifier is used to condition the differential output voltage of the bridge. The gain of the AD620 is programmed using an external resistor R_G and determined by

$$G = \frac{49.9 \text{ k}\Omega}{R_G} + 1$$

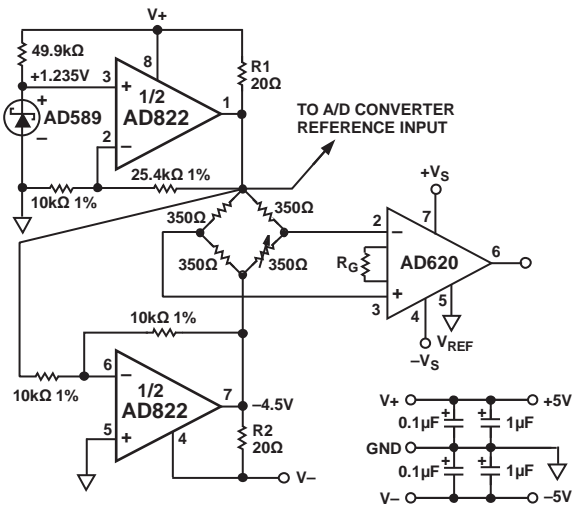

Figure 50. Low Dropout Bipolar Bridge Driver

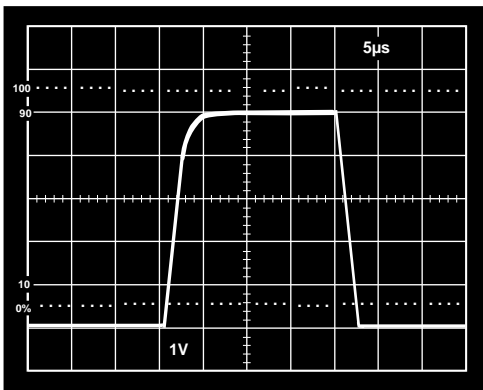
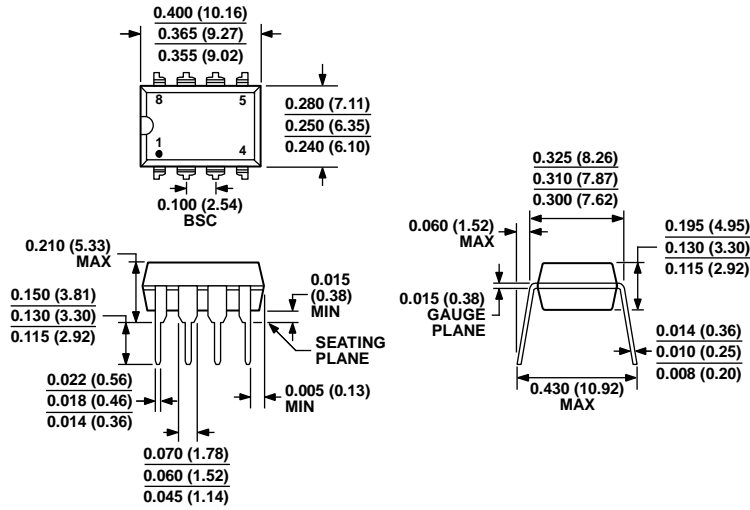

Figure 48. Pulse Response of In-Amp to a 500 mV p-p Input Signal; V_S = 5 V, 0 V; Gain = 0

OUTLINE DIMENSIONS



COMPLIANT TO JEDEC STANDARDS MS-001
 CONTROLLING DIMENSIONS ARE IN INCHES; MILLIMETER DIMENSIONS (IN PARENTHESES) ARE ROUNDED-OFF INCH EQUIVALENTS FOR REFERENCE ONLY AND ARE NOT APPROPRIATE FOR USE IN DESIGN. CORNER LEADS MAY BE CONFIGURED AS WHOLE OR HALF LEADS.

Figure 51. 8-Lead Plastic Dual In-Line Package (PDIP) Narrow Body (N-8)
 Dimensions shown in inches and (millimeters)

070606-A

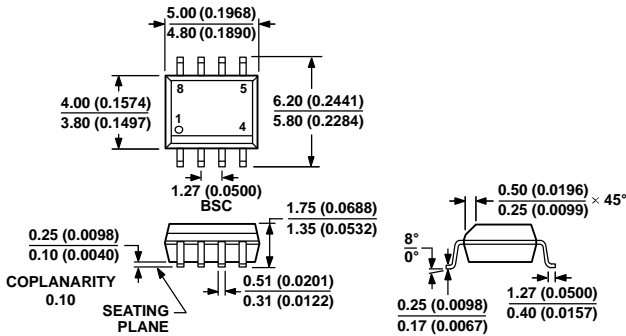

COMPLIANT TO JEDEC STANDARDS MS-012-AA
 CONTROLLING DIMENSIONS ARE IN MILLIMETERS; INCH DIMENSIONS (IN PARENTHESES) ARE ROUNDED-OFF MILLIMETER EQUIVALENTS FOR REFERENCE ONLY AND ARE NOT APPROPRIATE FOR USE IN DESIGN.

Figure 52. 8-Lead Standard Small Outline Package (SOIC_N) Narrow Body (R-8)
 Dimensions shown in millimeters and (inches)

012407-A

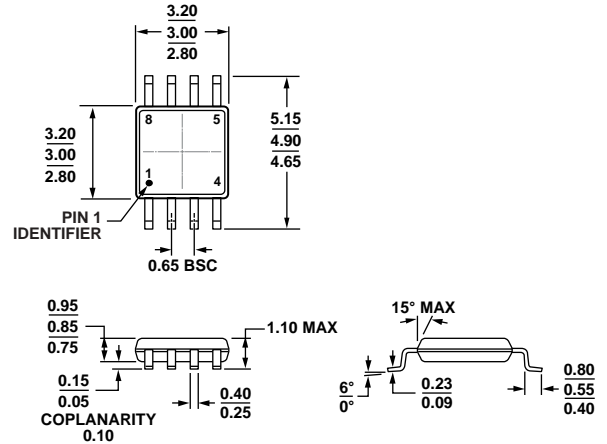

COMPLIANT TO JEDEC STANDARDS MO-187-AA
 Figure 53. 8-Lead Mini Small Outline Package (MSOP) (RM-8)
 Dimensions shown in millimeters

100709-B

AD822

ORDERING GUIDE

Model ¹	Temperature Range	Package Description	Package Option	Branding
AD822AN	-40°C to +85°C	8-Lead PDIP	N-8	
AD822ANZ	-40°C to +85°C	8-Lead PDIP	N-8	
AD822AR	-40°C to +85°C	8-Lead SOIC_N	R-8	
AD822AR-REEL	-40°C to +85°C	8-Lead SOIC_N	R-8	
AD822AR-REEL7	-40°C to +85°C	8-Lead SOIC_N	R-8	
AD822ARZ	-40°C to +85°C	8-Lead SOIC_N	R-8	
AD822ARZ-REEL	-40°C to +85°C	8-Lead SOIC_N	R-8	
AD822ARZ-REEL7	-40°C to +85°C	8-Lead SOIC_N	R-8	
AD822ARMZ	-40°C to +85°C	8-Lead MSOP	RM-8	#B4A
AD822ARMZ-REEL	-40°C to +85°C	8-Lead MSOP	RM-8	#B4A
AD822BR	-40°C to +85°C	8-Lead SOIC_N	R-8	
AD822BR-REEL	-40°C to +85°C	8-Lead SOIC_N	R-8	
AD822BR-REEL7	-40°C to +85°C	8-Lead SOIC_N	R-8	
AD822BRZ	-40°C to +85°C	8-Lead SOIC_N	R-8	
AD822BRZ-REEL	-40°C to +85°C	8-Lead SOIC_N	R-8	
AD822BRZ-REEL7	-40°C to +85°C	8-Lead SOIC_N	R-8	

¹ Z = RoHS Compliant Part, # denotes RoHS-compliant product may be top or bottom marked.

SPICE model is available at www.analog.com.

NOTES

AD822

NOTES



Компания «ЭлектроПласт» предлагает заключение долгосрочных отношений при поставках импортных электронных компонентов на взаимовыгодных условиях!

Наши преимущества:

- Оперативные поставки широкого спектра электронных компонентов отечественного и импортного производства напрямую от производителей и с крупнейших мировых складов;
- Поставка более 17-ти миллионов наименований электронных компонентов;
- Поставка сложных, дефицитных, либо снятых с производства позиций;
- Оперативные сроки поставки под заказ (от 5 рабочих дней);
- Экспресс доставка в любую точку России;
- Техническая поддержка проекта, помощь в подборе аналогов, поставка прототипов;
- Система менеджмента качества сертифицирована по Международному стандарту ISO 9001;
- Лицензия ФСБ на осуществление работ с использованием сведений, составляющих государственную тайну;
- Поставка специализированных компонентов (Xilinx, Altera, Analog Devices, Intersil, Interpoint, Microsemi, Aeroflex, Peregrine, Syfer, Eurofarad, Texas Instrument, Miteq, Cobham, E2V, MA-COM, Hittite, Mini-Circuits, General Dynamics и др.);

Помимо этого, одним из направлений компании «ЭлектроПласт» является направление «Источники питания». Мы предлагаем Вам помощь Конструкторского отдела:

- Подбор оптимального решения, техническое обоснование при выборе компонента;
- Подбор аналогов;
- Консультации по применению компонента;
- Поставка образцов и прототипов;
- Техническая поддержка проекта;
- Защита от снятия компонента с производства.



Как с нами связаться

Телефон: 8 (812) 309 58 32 (многоканальный)

Факс: 8 (812) 320-02-42

Электронная почта: org@eplast1.ru

Адрес: 198099, г. Санкт-Петербург, ул. Калинина, дом 2, корпус 4, литера А.